



US00D927054S

(12) **United States Design Patent** (10) **Patent No.:** **US D927,054 S**
Liu (45) **Date of Patent:** **** *Aug. 3, 2021**

(54) **ELECTRONIC CIGARETTE**
(71) Applicant: **Tuanfang Liu**, Shenzhen (CN)
(72) Inventor: **Tuanfang Liu**, Shenzhen (CN)
(*) Notice: This patent is subject to a terminal disclaimer.

2016/0024; A61M 2202/0007; A61M 2205/3334; A61M 2205/584; A61M 2205/587; A61M 2205/8256; A61M 2206/16; A61M 11/003; A61M 11/047; A61M 11/06; A61M 15/0003; A61M 15/0028; A61M 15/0035; A61M 15/004; A61M 2016/0015; A61M
(Continued)

(**) Term: **15 Years**

(56) **References Cited**

(21) Appl. No.: **29/710,708**

U.S. PATENT DOCUMENTS

(22) Filed: **Oct. 25, 2019**

D252,558 S * 8/1979 Beck D27/184
D723,735 S * 3/2015 Liu D27/189
(Continued)

(30) **Foreign Application Priority Data**

FOREIGN PATENT DOCUMENTS

May 15, 2019 (CN) 201930234044.4

(51) **LOC (13) Cl.** **27-02**

(52) **U.S. Cl.**
USPC **D27/162**

EM 006690848-0001 * 9/2019
KR 3020180022513 * 6/2019

(58) **Field of Classification Search**
USPC D27/100, 101, 162, 163, 164, 165, 166, D27/167, 168, 169, 183, 184, 185; D24/110

Primary Examiner — Marissa J Cash
Assistant Examiner — William B Melliar
(74) *Attorney, Agent, or Firm* — Matthias Scholl P.C.; Matthias Scholl

CPC A24F 47/008; A24F 40/10; A24F 40/42; A24F 40/51; A24F 47/00; A24F 40/40; A24F 40/46; A24F 40/50; A24F 40/60; A24F 40/53; A24F 40/90; A24F 40/20; A24F 40/485; A24F 40/57; A24F 40/65; A24F 40/44; A24F 47/002; A24F 40/48; A24F 40/70; A24F 13/00; A24F 40/30; A24F 40/95; A24F 42/60; A24F 7/00; A24F 40/465; A24F 42/10; A24F 42/20; A24F 1/00; A24F 1/32; A24F 40/00; A24F 40/05; A24F 42/00; A24F 47/004; A24F 47/006; A24F 7/02; A61M 11/042; A61M 15/06; A61M 2205/8206; A61M 11/005; A61M 2202/064; A61M 2205/3653; A61M 2205/50; A61M 15/0001; A61M 15/003; A61M 15/009; A61M 16/0003; A61M 2016/0027; A61M 11/044; A61M 15/0021; A61M 15/0041; A61M 15/0065; A61M 15/0085; A61M

(57) **CLAIM**

The ornamental design for an electronic cigarette, as shown and described.

DESCRIPTION

FIG. 1 is a front elevation view of an electronic cigarette; FIG. 2 is a rear elevation view thereof; FIG. 3 is a left-side elevation view thereof; FIG. 4 is a right-side elevation view thereof; FIG. 5 is a top plan view thereof; FIG. 6 is a bottom plan view thereof; FIG. 7 is a perspective view thereof; and, FIG. 8 is a bottom perspective view thereof. The broken lines in the drawings depict portions of the electronic cigarette that form no part of the claimed design.

1 Claim, 8 Drawing Sheets

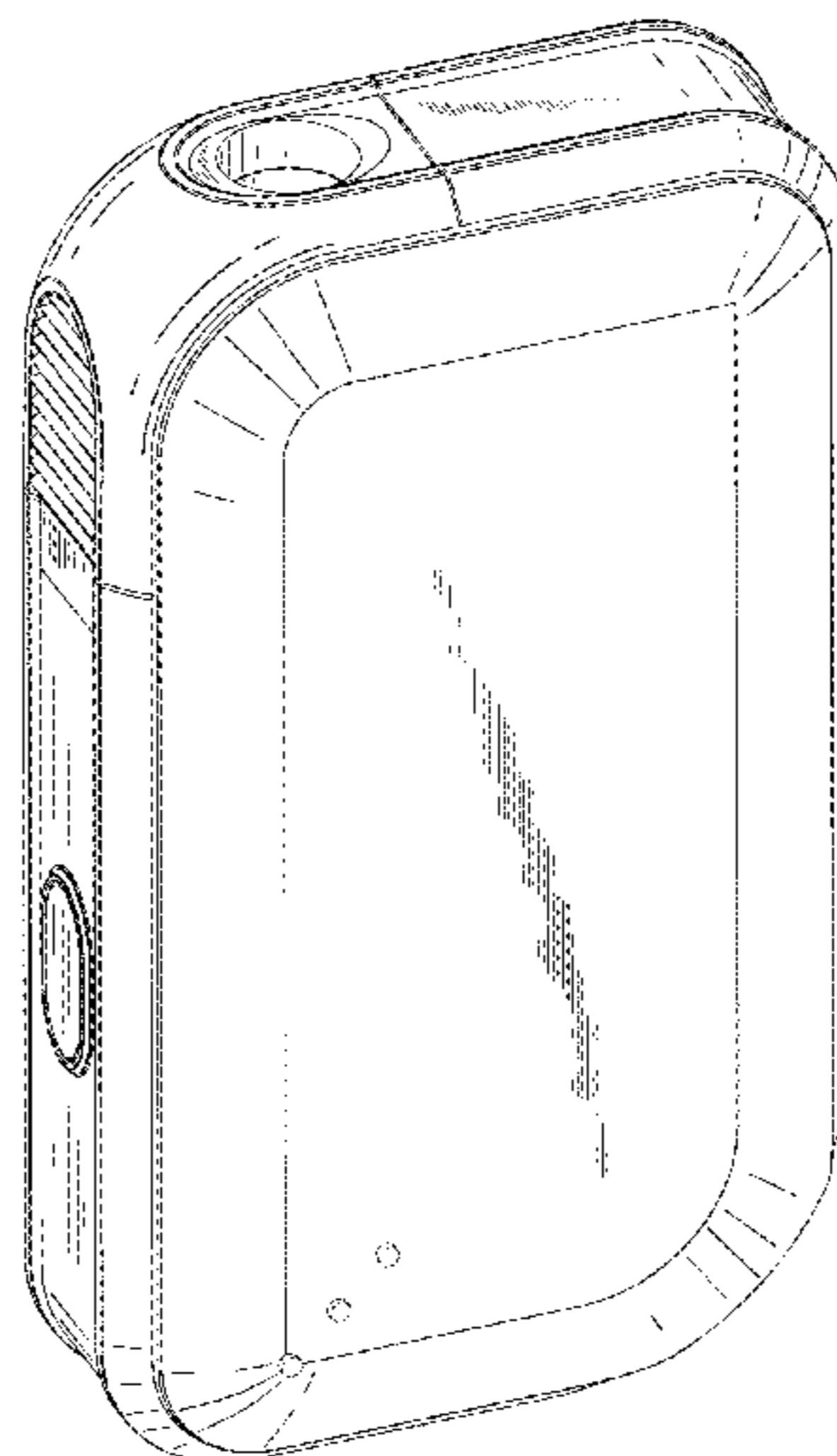

(58) **Field of Classification Search**

CPC 2016/003; A61M 2021/0016; A61M 2037/0023; A61M 2037/0061; A61M 21/00; A61M 21/02; A61M 2205/0211; A61M 2205/273; A61M 2205/3317; A61M 2205/3331; A61M 2205/3368; A61M 2205/3379; A61M 2205/3561; A61M 2205/502; A61M 2205/52; A61M 2205/581; A61M 2205/582; A61M 2205/75; A61M 2205/8243; A61M 37/0015; A24B 15/167; A24B 15/16; A24B 13/00; A24B 15/00; A24B 15/10; A24B 15/14; A24B 15/165; A24B 15/186; A24B 15/20; A24B 15/243; A24B 15/245; A24B 15/283; A24B 15/284; A24B 15/286; A24B 15/30; A24B 15/32; A24B 15/34; A24B 15/403; A24D 1/20; A24D 1/002; A24D 1/14; A24D 3/048;

A24D 1/025; A24D 1/045; A24D 3/04; A24D 3/061; A24D 3/14; A24D 3/17

See application file for complete search history.

(56)

References Cited

U.S. PATENT DOCUMENTS

D723,737	S	*	3/2015	Liu	D27/189
D733,356	S	*	6/2015	Leidel	D27/163
D759,302	S	*	6/2016	Gadas	D27/163
D788,362	S	*	5/2017	Qiu	D27/101
D869,086	S	*	12/2019	Pan	D27/162
D886,366	S	*	6/2020	Liu	D27/162
D892,396	S	*	8/2020	Lai	D27/162
D897,596	S	*	9/2020	Huang	D27/162
D898,280	S	*	10/2020	Li	D27/162
2019/0069601	A1	*	3/2019	Qiu	A24F 47/008
2020/0214359	A1	*	7/2020	Liu	A24F 7/00

* cited by examiner

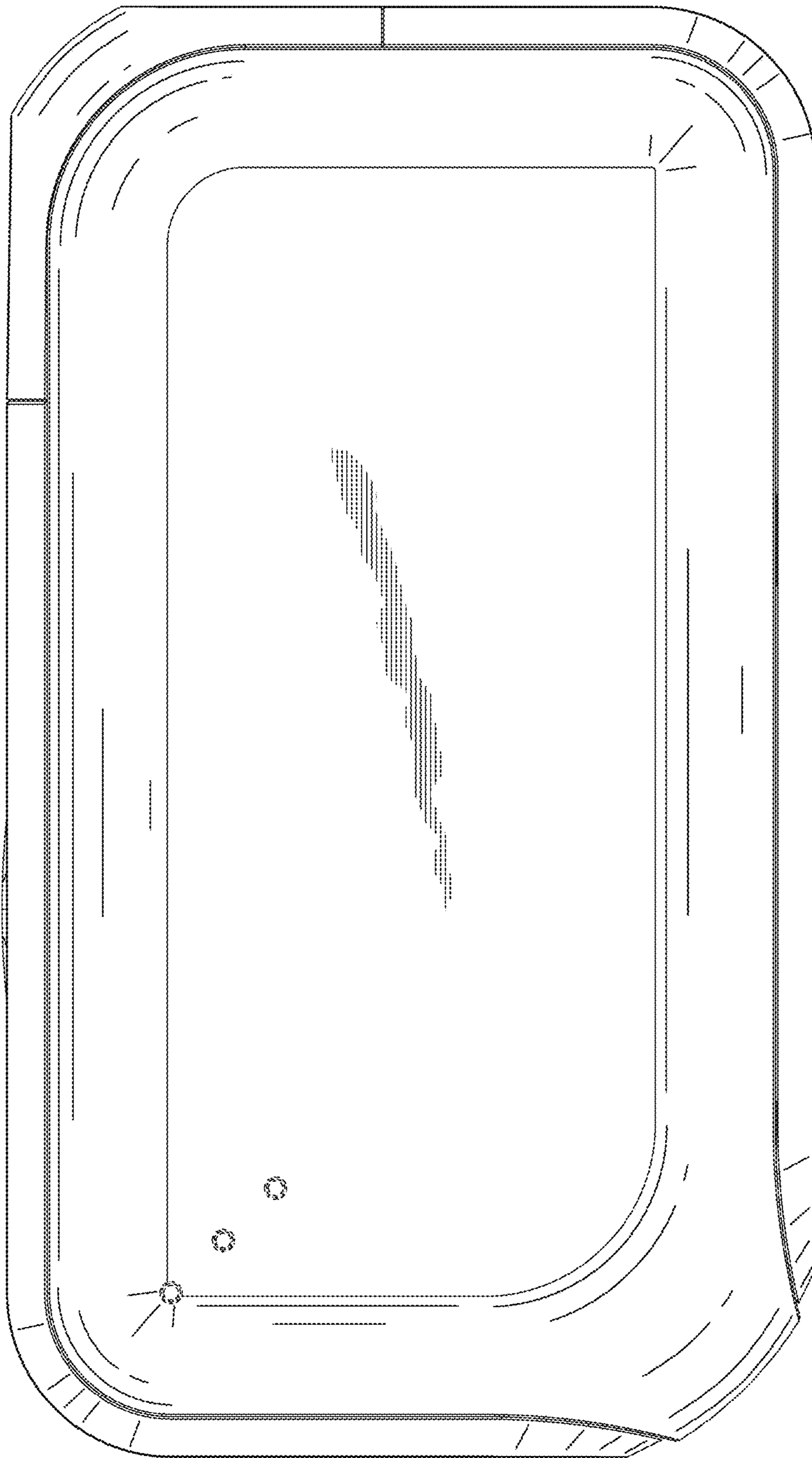

FIG. 1

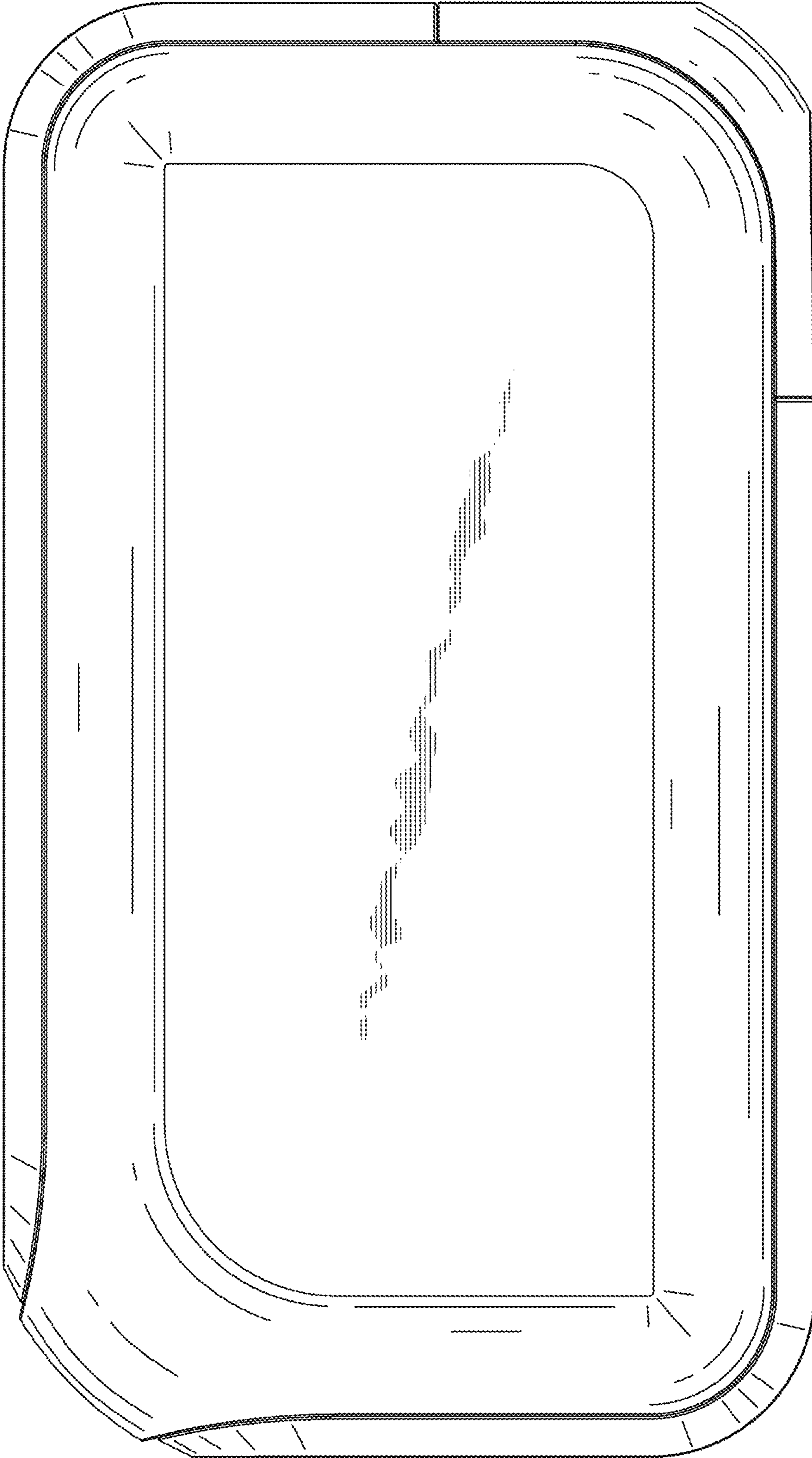

FIG. 2

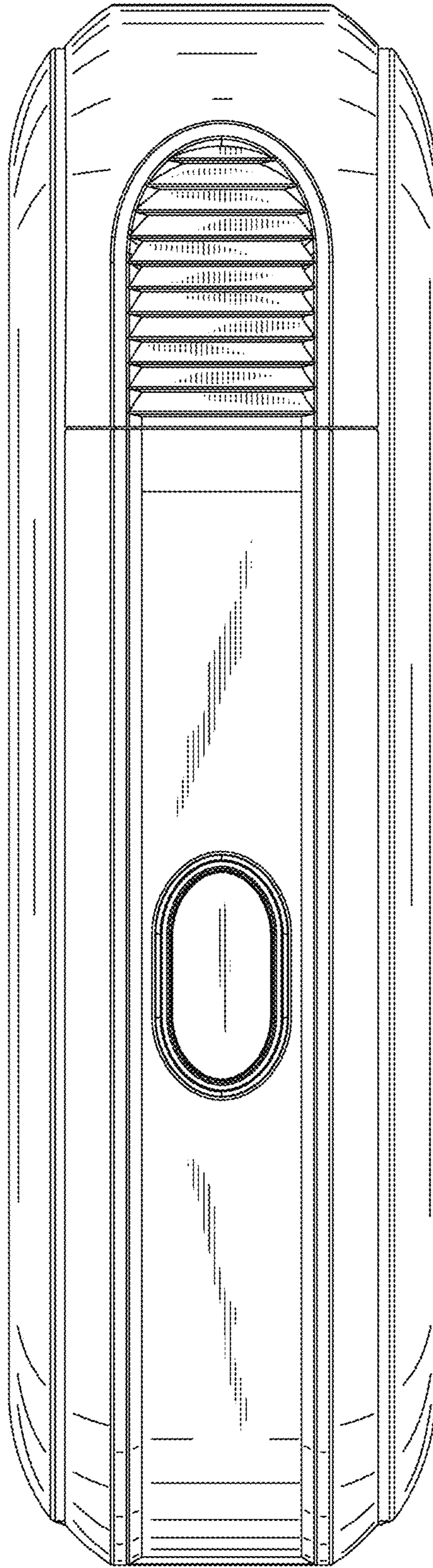

FIG. 3

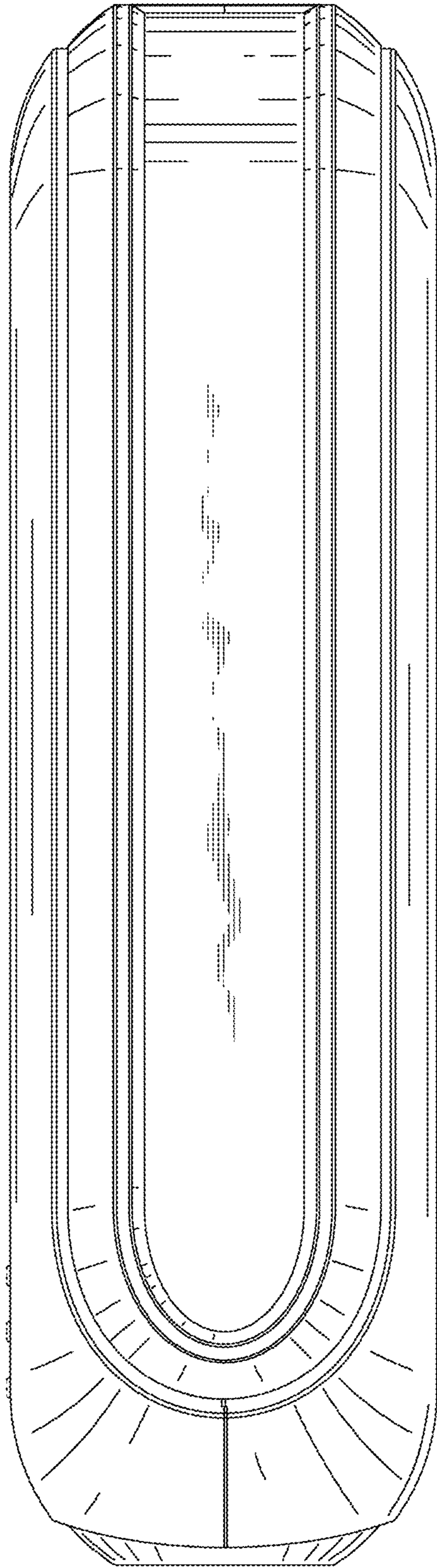

FIG. 4

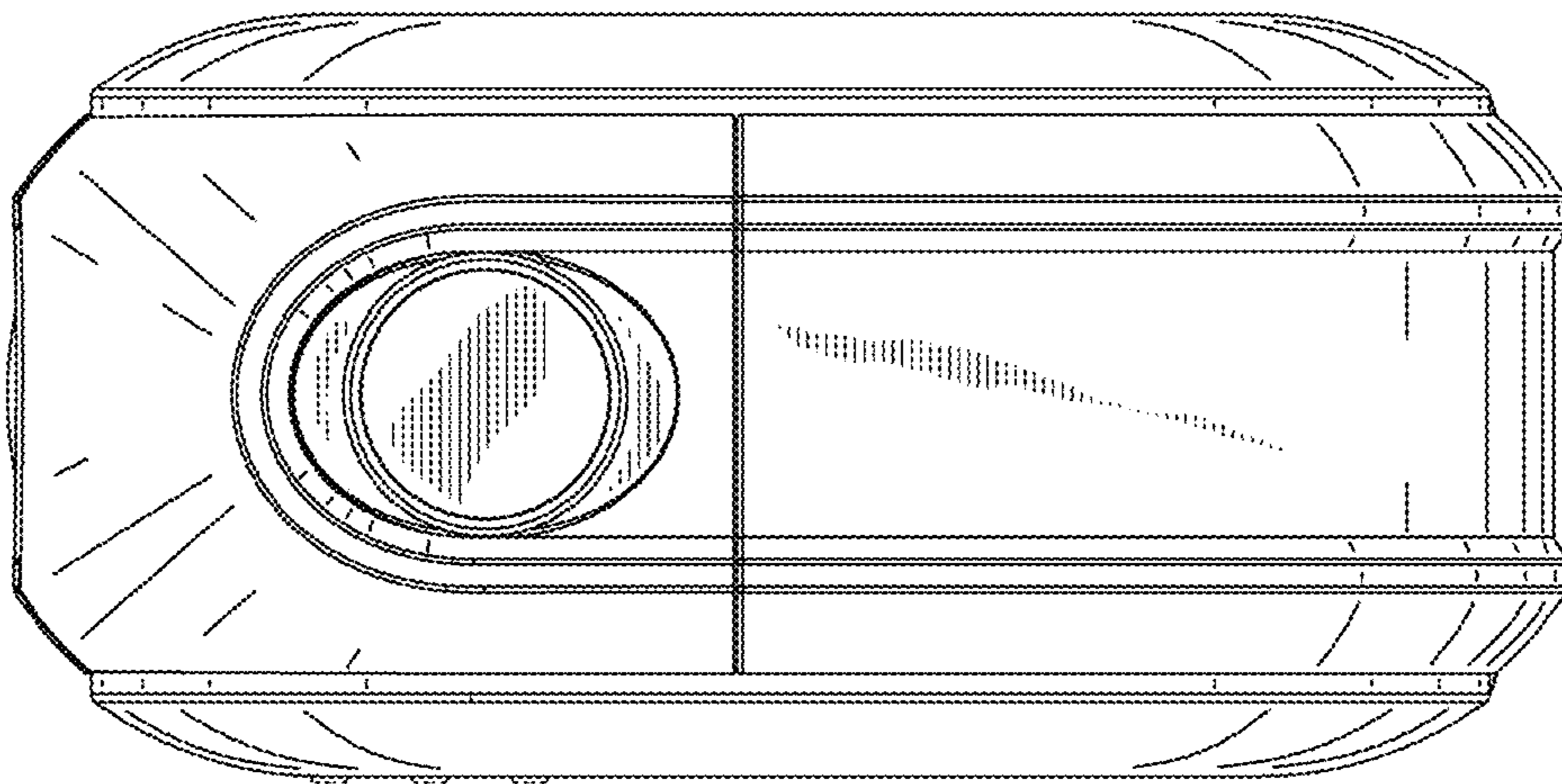

FIG. 5

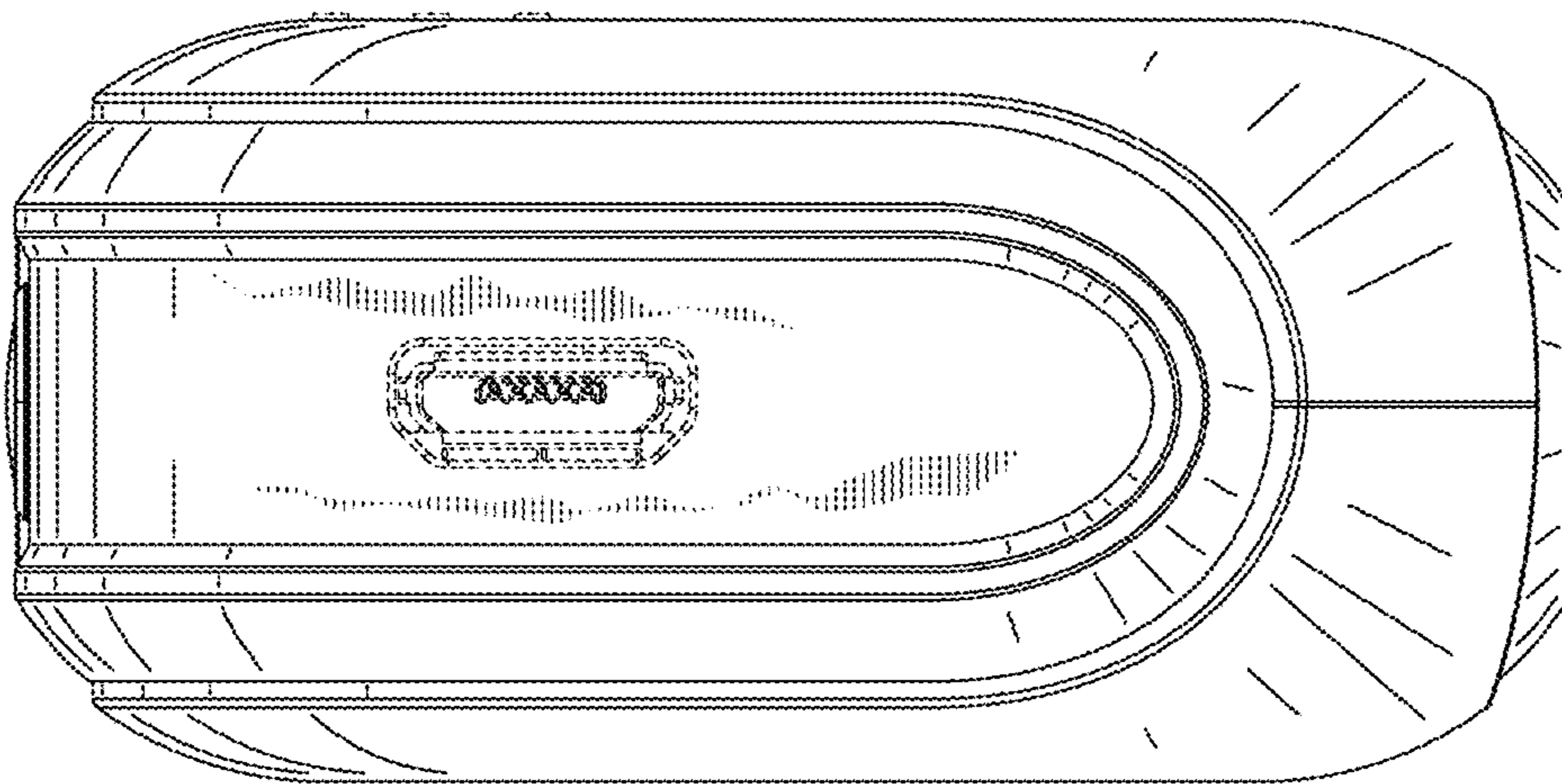

FIG. 6

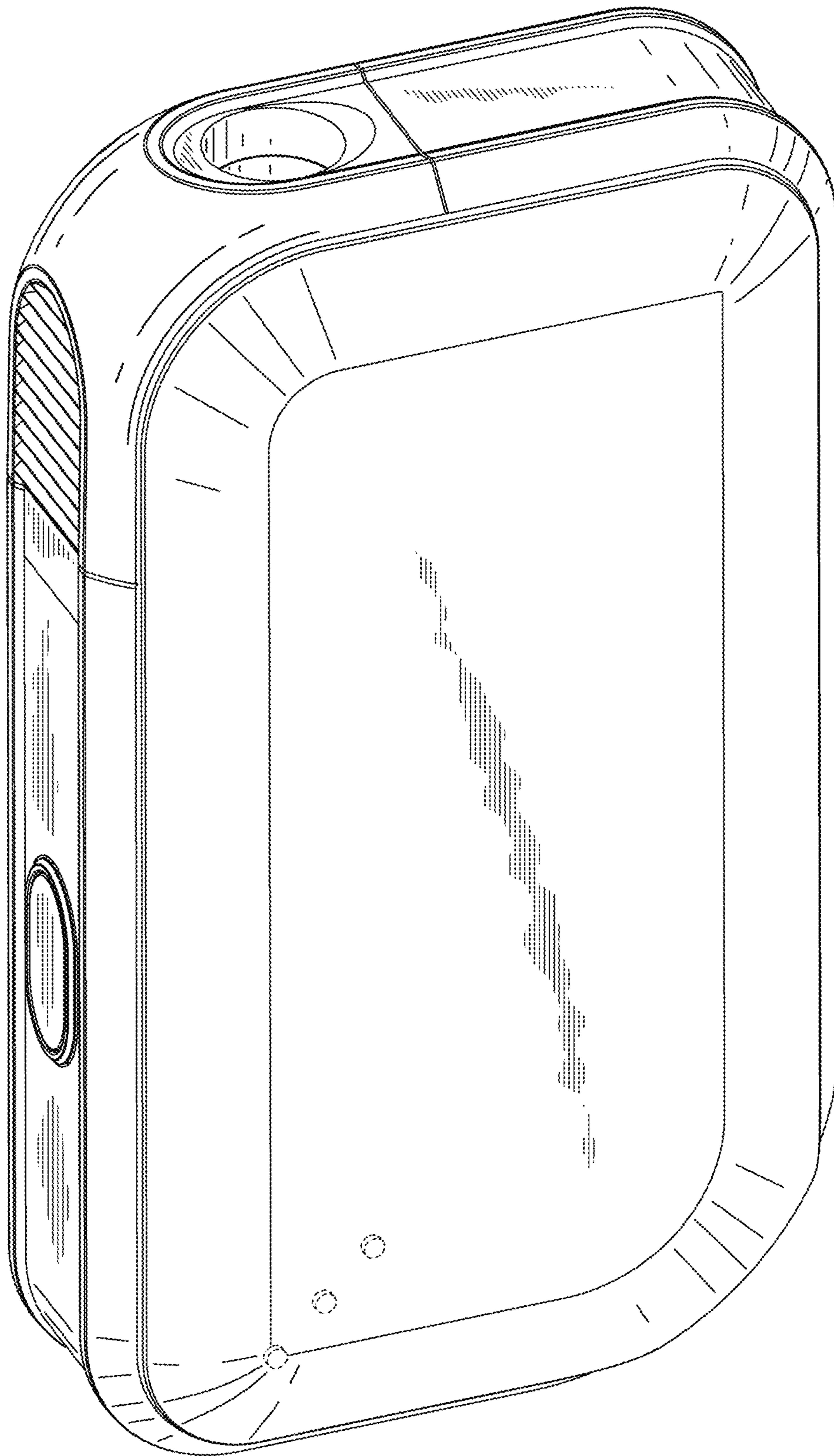

FIG. 7

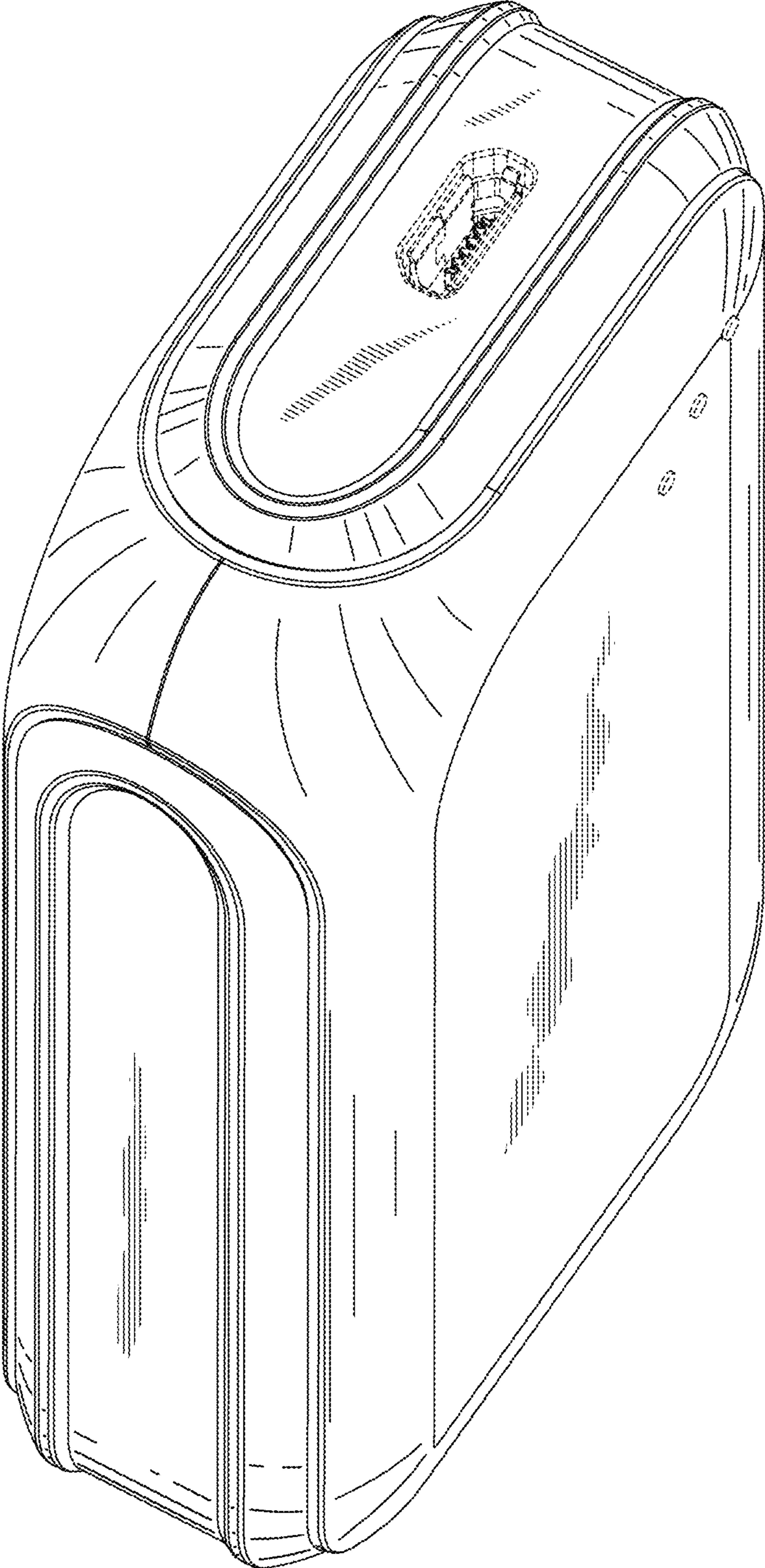

FIG. 8