



US00D926900S

(12) **United States Design Patent** (10) **Patent No.:** **US D926,900 S**  
**Nicolette et al.** (45) **Date of Patent:** **\*\* Aug. 3, 2021**

(54) <b>GOLF CLUB HEAD</b>	D261,167 S	10/1981	Swanson	
	D294,617 S *	3/1988	Perkins .....	D21/749
(71) Applicant: <b>PARSONS XTREME GOLF, LLC,</b> Scottsdale, AZ (US)	4,754,977 A *	7/1988	Sahm .....	A63B 53/047 473/337
	4,824,116 A	4/1989	Nagamoto	
(72) Inventors: <b>Michael R. Nicolette,</b> Scottsdale, AZ (US); <b>Bradley D. Schweigert,</b> Cave Creek, AZ (US)	4,988,104 A	1/1991	Shiotani	
	5,158,296 A *	10/1992	Lee .....	A63B 53/04 473/327
	5,176,384 A	1/1993	Sata	
	5,213,328 A	5/1993	Long	
(73) Assignee: <b>PARSONS XTREME GOLF, LLC,</b> Scottsdale, AZ (US)	D336,672 S	6/1993	Gorman	
	D353,862 S	12/1994	Saito	
	D357,520 S	4/1995	Schmidt	
	5,419,560 A	5/1995	Bamber	
(**) Term: <b>15 Years</b>	5,425,535 A	6/1995	Gee	
	D361,358 S	8/1995	Simmons	
(21) Appl. No.: <b>29/711,139</b>	5,447,311 A	9/1995	Viollaz	
	5,451,056 A	9/1995	Manning	
(22) Filed: <b>Oct. 29, 2019</b>	D362,884 S	10/1995	Sheeley	
	D362,885 S	10/1995	Sheeley	
	D362,887 S	10/1995	Sheeley	
	D370,514 S	6/1996	Sheeley	
	5,540,437 A	7/1996	Bamber	
	D379,106 S	5/1997	Maltby	
	5,637,045 A	6/1997	Igarashi	
	5,669,830 A	9/1997	Bamber	
	D389,540 S	1/1998	Mendenhall	
	D389,541 S	1/1998	Huan-Chiang	
	D395,476 S	6/1998	Pond et al.	
	5,766,091 A	6/1998	Humphrey	
	5,766,092 A	6/1998	Mimeur	
	D399,277 S	10/1998	Ezaki	
	5,827,132 A	10/1998	Bamber	
	D408,485 S	4/1999	Sasaki	
	5,899,821 A	5/1999	Hsu	
	5,935,016 A	8/1999	Antonious	
	D414,535 S	9/1999	Mertens	
	D421,080 S *	2/2000	Chen .....	D21/747
	D426,276 S *	6/2000	Besnard .....	D21/747
	D426,476 S	6/2000	Goss	
	6,077,171 A *	6/2000	Yoneyama .....	A63B 60/00 473/291
	D442,659 S	5/2001	Solheim	
	D443,008 S	5/2001	Kubica	
	D445,862 S	7/2001	Ford	
	6,290,609 B1	9/2001	Takeda	
	D449,866 S	10/2001	Miller	
	D457,211 S	5/2002	Bakke	
	D458,328 S	6/2002	Nicolette	
	D469,833 S	2/2003	Roberts	
	D473,605 S	4/2003	Petersen	
	D475,107 S	5/2003	Madore	
	D476,048 S	6/2003	Cleveland	

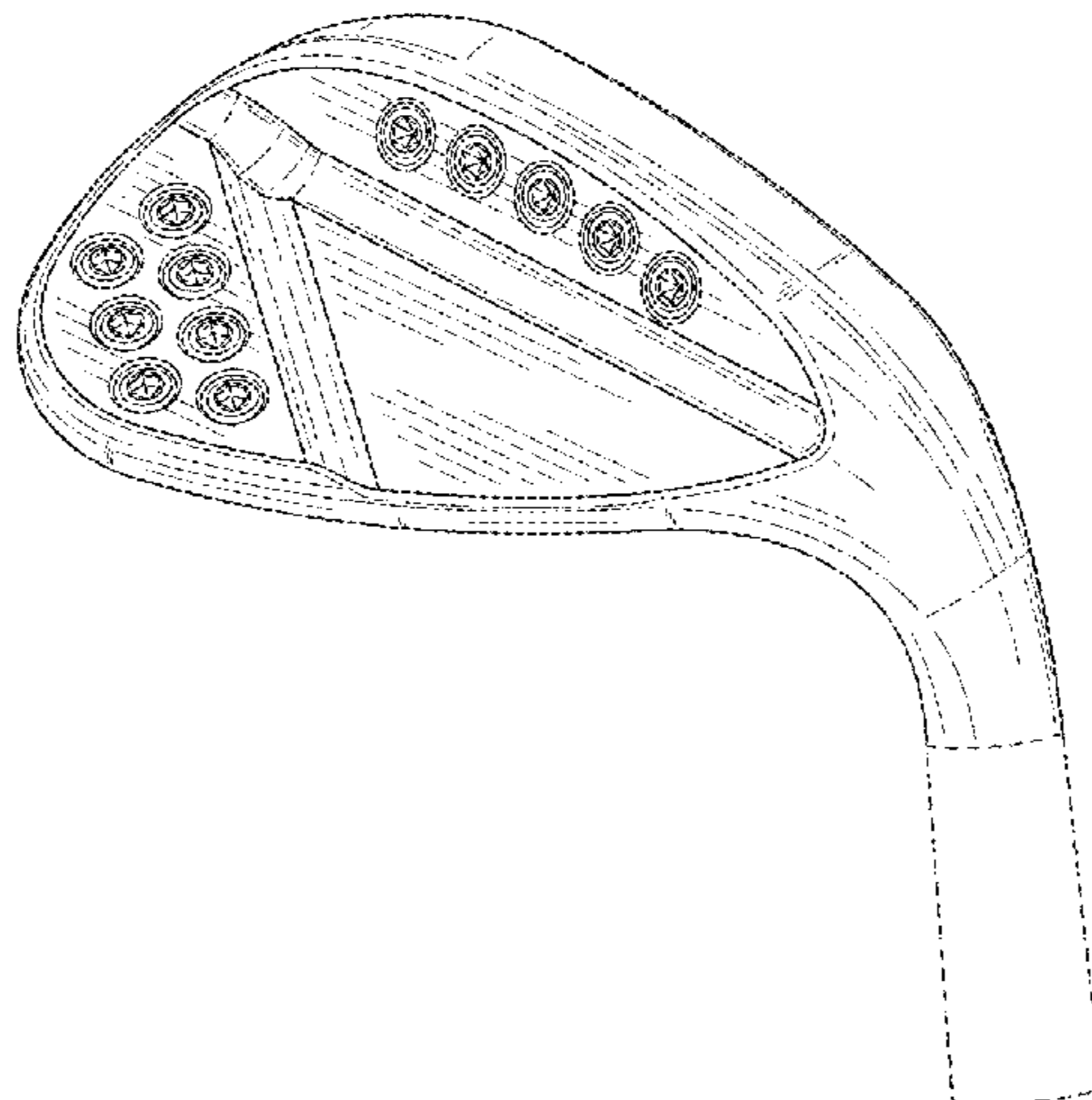
**Related U.S. Application Data**

- (63) Continuation-in-part of application No. 29/691,698, filed on May 17, 2019, now abandoned.
- (51) **LOC (13) Cl.** ..... **21-02**
- (52) **U.S. Cl.**  
USPC ..... **D21/747**
- (58) **Field of Classification Search**  
USPC ..... D21/747-751, 759  
CPC ..... A63B 53/00; A63B 53/02; A63B 53/04;  
A63B 53/047; A63B 53/0475; A63B  
2053/0479; A63B 2053/0483; A63B  
2053/0445; A63B 60/00; A63B 60/46  
See application file for complete search history.

**References Cited**

**U.S. PATENT DOCUMENTS**

1,133,129 A	3/1915	Govan
D164,469 S	9/1951	Behrendt
3,020,048 A	2/1962	Carroll
D203,936 S	3/1966	Long
D215,101 S	9/1969	Sabat
D234,963 S	4/1975	Hirata
D239,550 S	4/1976	Timbrook
D240,054 S	5/1976	Meissler
D244,792 S	6/1977	Gelinas
D250,136 S	10/1978	Gelinas



# US D926,900 S

D478,949 S	8/2003	De La Cruz		D594,518 S	6/2009	Schweigert	
6,638,182 B2	10/2003	Kosmatka		D596,256 S	7/2009	Nicolette	
6,695,714 B1	2/2004	Bliss		D596,257 S	7/2009	Nicolette	
6,702,693 B2	3/2004	Bamber		D596,258 S	7/2009	Jertson	
D488,201 S	4/2004	Wahl		D596,688 S	7/2009	Chen	
D492,376 S	6/2004	Schweigert		D597,158 S	7/2009	Nicolette	
D494,240 S	8/2004	Schweigert		D601,216 S	9/2009	Nicolette	
D494,648 S	8/2004	Schweigert		7,588,502 B2	9/2009	Nishino	
6,780,123 B2	8/2004	Hasebe		7,601,075 B2	10/2009	Cole	
D497,963 S	11/2004	Toulon		D604,783 S	11/2009	Solheim	
6,811,496 B2	11/2004	Wahl		7,611,424 B2	11/2009	Nagai	
D499,779 S	12/2004	Mahaffey		D606,605 S	12/2009	Ban	
D500,350 S	12/2004	Schweigert		D607,070 S	12/2009	Ban	
D500,351 S	12/2004	Schweigert		D607,071 S	12/2009	Ban	
D502,237 S	2/2005	Schweigert		7,658,686 B2	2/2010	Soracco	
D502,975 S	3/2005	Schweigert et al.		D612,438 S	3/2010	Carlyle	
D503,204 S	3/2005	Nicolette et al.		D612,439 S	3/2010	Carlyle	
D504,925 S	5/2005	Schweigert		D617,406 S	6/2010	Carlyle	
D505,171 S	5/2005	Solheim		D618,293 S	6/2010	Foster et al.	
D507,320 S	7/2005	Roberts et al.		7,736,243 B2	6/2010	Sanchez	
D507,614 S	7/2005	Schweigert		7,744,484 B1	6/2010	Chao	
D508,099 S	8/2005	Solheim		D621,893 S	8/2010	Nicolette	
D508,545 S	8/2005	Roberts et al.		D621,894 S	8/2010	Schweigert	
6,923,733 B2	8/2005	Chen		D621,895 S	8/2010	Schweigert	
D514,183 S	1/2006	Schweigert		7,798,917 B2	9/2010	Nguyen	
D516,650 S	3/2006	Stone		7,815,521 B2	10/2010	Ban	
D518,863 S	4/2006	Nishitani		D627,409 S	11/2010	Schweigert	
D523,501 S	6/2006	Schweigert		D627,410 S	11/2010	Nicolette et al.	
D523,917 S	6/2006	Roberts		7,846,040 B2	12/2010	Ban	
D524,889 S	7/2006	Kim		D633,159 S	2/2011	Manwaring	
D530,759 S	10/2006	Solheim		D633,967 S	3/2011	Carlyle	
D530,760 S	10/2006	Solheim		D635,627 S	4/2011	Nicolette	
7,121,956 B2 *	10/2006	Lo .....	A63B 53/0466 473/335	7,938,738 B2	5/2011	Roach	
				D642,642 S	8/2011	Schweigert	
7,128,663 B2	10/2006	Bamber		D643,488 S	8/2011	Manwaring	
D531,688 S	11/2006	Wahl		D643,490 S	8/2011	Ban	
D532,849 S	11/2006	Solheim		D643,491 S	8/2011	Solheim	
D534,228 S	12/2006	Solheim		D643,492 S	8/2011	Nicolette	
D534,595 S	1/2007	Hasebe		D643,895 S	8/2011	Wieland	
D534,597 S	1/2007	Solheim		D643,896 S	8/2011	Schweigert	
7,156,751 B2	1/2007	Wahl		D647,582 S	10/2011	Nicolette	
D536,759 S	2/2007	Nicolette		D649,211 S	11/2011	Schweigert	
D537,494 S	2/2007	Solheim		8,062,150 B2	11/2011	Gilbert	
7,182,698 B2	2/2007	Tseng		D651,268 S	12/2011	Nicolette	
D538,366 S	3/2007	Nicolette		8,088,025 B2	1/2012	Wahl	
D539,864 S	4/2007	Solheim		8,092,319 B1	1/2012	Cackett	
D540,898 S	4/2007	Solheim		8,105,180 B1	1/2012	Cackett	
D541,360 S	4/2007	Solheim		8,142,307 B2	3/2012	Sanchez	
7,207,900 B2	4/2007	Nicolette		D658,248 S	4/2012	Toulon	
D543,601 S *	5/2007	Kawami .....	D21/759	8,221,262 B1	7/2012	Cackett	
D544,056 S	6/2007	Solheim		8,246,487 B1	8/2012	Cackett	
D547,410 S	7/2007	Solheim		D670,775 S	11/2012	Schweigert	
D555,219 S *	11/2007	Lin .....	D21/759	D672,417 S	12/2012	Schweigert	
7,303,486 B2	12/2007	Imamoto		8,328,662 B2	12/2012	Nakamura	
D559,932 S	1/2008	Belmont		D673,633 S	1/2013	Schweigert	
D561,855 S	2/2008	Nicolette		D673,634 S	1/2013	Schweigert	
D562,925 S	2/2008	Nicolette		8,376,878 B2	2/2013	Bennett	
7,351,164 B2	4/2008	Schweigert		D680,603 S	4/2013	Nicolette	
D570,435 S	6/2008	Sanchez		D681,142 S	4/2013	Fossum et al.	
D570,935 S	6/2008	Nicolette		D681,143 S	4/2013	Nicolette	
D570,936 S	6/2008	Nicolette		8,414,422 B2	4/2013	Peralta	
D570,942 S	6/2008	Schweigert		8,506,420 B2	8/2013	Hocknell	
D571,422 S	6/2008	Nicolette		8,545,343 B2	10/2013	Boyd	
D571,425 S	6/2008	Nicolette		8,574,094 B2	11/2013	Nicolette	
D571,427 S	6/2008	Schweigert		8,657,700 B2	2/2014	Nicolette	
D571,881 S	6/2008	Solheim		8,663,026 B2	3/2014	Blowers	
D572,326 S	7/2008	Schweigert		8,690,710 B2	4/2014	Nicolette	
D572,329 S	7/2008	Solheim		D707,316 S	6/2014	Brunski	
D573,219 S	7/2008	Schweigert		D707,317 S	6/2014	Brunski	
7,396,299 B2	7/2008	Nicolette		8,753,230 B2	6/2014	Stokke	
7,413,518 B2	8/2008	Cole		D708,688 S	7/2014	Nicolette	
D577,783 S	9/2008	Nicolette		8,827,832 B2	9/2014	Breier	
D578,590 S	10/2008	Nicolette		8,827,833 B2	9/2014	Amano	
D581,000 S	11/2008	Sanchez		8,845,455 B2	9/2014	Ban	
D581,004 S	11/2008	Chen		D716,387 S	10/2014	Brunski	
D584,370 S	1/2009	Cleveland		D716,388 S	10/2014	Brunski	
D585,103 S	1/2009	Tang		D716,391 S	10/2014	Kim	
D586,414 S	2/2009	Tang		D722,352 S *	2/2015	Nicolette .....	D21/747
D587,327 S	2/2009	Wahl		D723,120 S *	2/2015	Nicolette .....	D21/747

8,961,336	B1 *	2/2015	Parsons	.....	A63B 53/0475 473/332
D726,265	S *	4/2015	Nicolette	.....	D21/747
9,199,143	B1	12/2015	Parsons		
D746,926	S *	1/2016	Parsons	.....	D21/747
D748,214	S *	1/2016	Nicolette	.....	D21/747
D748,749	S *	2/2016	Nicolette	.....	D21/759
D751,660	S *	3/2016	Greenlaw	.....	D21/759
D756,471	S *	5/2016	Nicolette	.....	D21/747
9,346,203	B2 *	5/2016	Parsons	.....	B29C 45/14467
D764,610	S	8/2016	Parsons		
9,421,437	B2	8/2016	Parsons		
9,427,634	B2	8/2016	Parsons		
D773,575	S *	12/2016	Nicolette	.....	D21/747
D795,979	S *	8/2017	Parsons	.....	D21/759
9,764,208	B1 *	9/2017	Parsons	.....	A63B 60/02
D802,068	S *	11/2017	Parsons	.....	D21/747
D816,787	S *	5/2018	Nicolette	.....	D21/747
D825,891	S *	8/2018	Parsons	.....	D2/747
D827,065	S *	8/2018	Nicolette	.....	D21/747
D835,737	S *	12/2018	Parsons	.....	D21/747
D856,451	S *	8/2019	Parsons	.....	D21/747
D863,478	S *	10/2019	Parsons	.....	D21/747
D864,326	S *	10/2019	Mickelson	.....	D21/747
10,729,948	B2 *	8/2020	Parsons	.....	A63B 53/047
10,729,949	B2 *	8/2020	Parsons	.....	A63B 60/54
2002/0107087	A1	8/2002	Fagot		
2003/0139226	A1	7/2003	Cheng		
2003/0176231	A1	9/2003	Hasebe		
2004/0204263	A1	10/2004	Fagot		
2005/0009632	A1	1/2005	Schweigert		
2005/0014573	A1	1/2005	Lee		
2005/0096148	A1	5/2005	Noble		
2005/0119066	A1	6/2005	Stites		
2005/0239569	A1	10/2005	Best		
2005/0277485	A1 *	12/2005	Hou	.....	A63B 60/54 473/332
2006/0111200	A1	5/2006	Poynor		
2007/0032308	A1	2/2007	Fagot		
2007/0225084	A1	9/2007	Schweigert		
2008/0058113	A1	3/2008	Nicolette		
2008/0188322	A1	8/2008	Anderson		
2008/0300065	A1	12/2008	Schweigert		
2009/0029790	A1	1/2009	Nicolette		
2010/0130306	A1	5/2010	Schweigert		
2010/0178999	A1	7/2010	Nicolette		
2011/0111683	A1	5/2011	Kelnhofer		
2011/0165963	A1	7/2011	Cackett		
2011/0269567	A1	11/2011	Ban		
2011/0294596	A1	12/2011	Ban		
2012/0267410	A1	10/2012	Loudenslager		
2013/0137532	A1	5/2013	Deshmukh		
2013/0225319	A1	8/2013	Kato		
2013/0281226	A1	10/2013	Ban		
2013/0288823	A1	10/2013	Hebreo		
2013/0303303	A1	11/2013	Ban		
2013/0310192	A1	11/2013	Wahl		
2014/0080621	A1	3/2014	Nicolette		
2014/0128175	A1	5/2014	Jertson		
2014/0274441	A1	9/2014	Greer		
2014/0274451	A1	9/2014	Knight		
2015/0136825	A1	5/2015	Kalck		
2015/0231454	A1 *	8/2015	Parsons	.....	A63B 53/06 473/335
2015/0231806	A1	8/2015	Parsons		
2015/0328508	A1 *	11/2015	Parsons	.....	A63B 53/0475 473/350
2017/0282027	A1 *	10/2017	Parsons	.....	B29C 45/14311
2017/0368429	A1 *	12/2017	Parsons	.....	A63B 60/02
2018/0050244	A1 *	2/2018	Parsons	.....	A63B 53/0475
2018/0050245	A1 *	2/2018	Parsons	.....	A63B 60/54
2018/0104550	A1 *	4/2018	Parsons	.....	A63B 60/02
2018/0104551	A1 *	4/2018	Parsons	.....	A63B 53/047
2018/0140910	A1 *	5/2018	Parsons	.....	A63B 53/0466
2018/0207494	A1 *	7/2018	Parsons	.....	A63B 53/0466
2018/0221727	A1 *	8/2018	Parsons	.....	A63B 53/047
2018/0236325	A1 *	8/2018	Parsons	.....	A63B 53/0466
2018/0318673	A1 *	11/2018	Parsons	.....	A63B 53/0487

2019/0143183	A1 *	5/2019	Parsons	.....	A63B 60/02 473/346
2019/0201758	A1 *	7/2019	Parsons	.....	A63B 53/0487
2019/0232124	A1 *	8/2019	Parsons	.....	A63B 53/0487
2019/0232125	A1 *	8/2019	Parsons	.....	A63B 60/02
2019/0232126	A1 *	8/2019	Nicolette	.....	A63B 53/0475
2019/0240549	A1 *	8/2019	Parsons	.....	A63B 53/047
2019/0247727	A1 *	8/2019	Parsons	.....	A63B 53/0475
2019/0336832	A1 *	11/2019	Parsons	.....	A63B 53/0475
2020/0047038	A1 *	2/2020	Parsons	.....	A63B 53/0475
2020/0070018	A1 *	3/2020	Parsons	.....	A63B 53/0466
2020/0346082	A1 *	11/2020	Parsons	.....	A63B 53/0466
2020/0353326	A1 *	11/2020	Parsons	.....	A63B 60/02
2020/0376353	A1 *	12/2020	Parsons	.....	A63B 53/047
2021/0008420	A1 *	1/2021	Parsons	.....	A63B 53/0487
2021/0016141	A1 *	1/2021	Parsons	.....	A63B 53/0475

OTHER PUBLICATIONS

International Search Report and Written Opinion Issued in connection with corresponding application No. PCT/US2015/016666, dated May 14, 2015 (7 Pages).

Kozuchowski, Zak, "Callaway Mack Daddy 2 PM Grind Wedges" (<http://golfwrz.com/276203/callaway-mack-daddy-2-pm-grind-wedges/>), www.golfwrz.com, GOLFWRX Holdings, LLC, Published Jan. 21, 2015.

Wall, Jonathan, "Details: Phil'S Prototype Mack Daddy PM-Grind Wedge," (<http://www.pgatour.com/equipmentreport/2015/01/21/callaway-wedge.html>), www.patour.com, PGA Tour, Inc., Published Jan. 21, 2015.

\* cited by examiner

Primary Examiner — Mitchell I. Siegel

(57) CLAIM

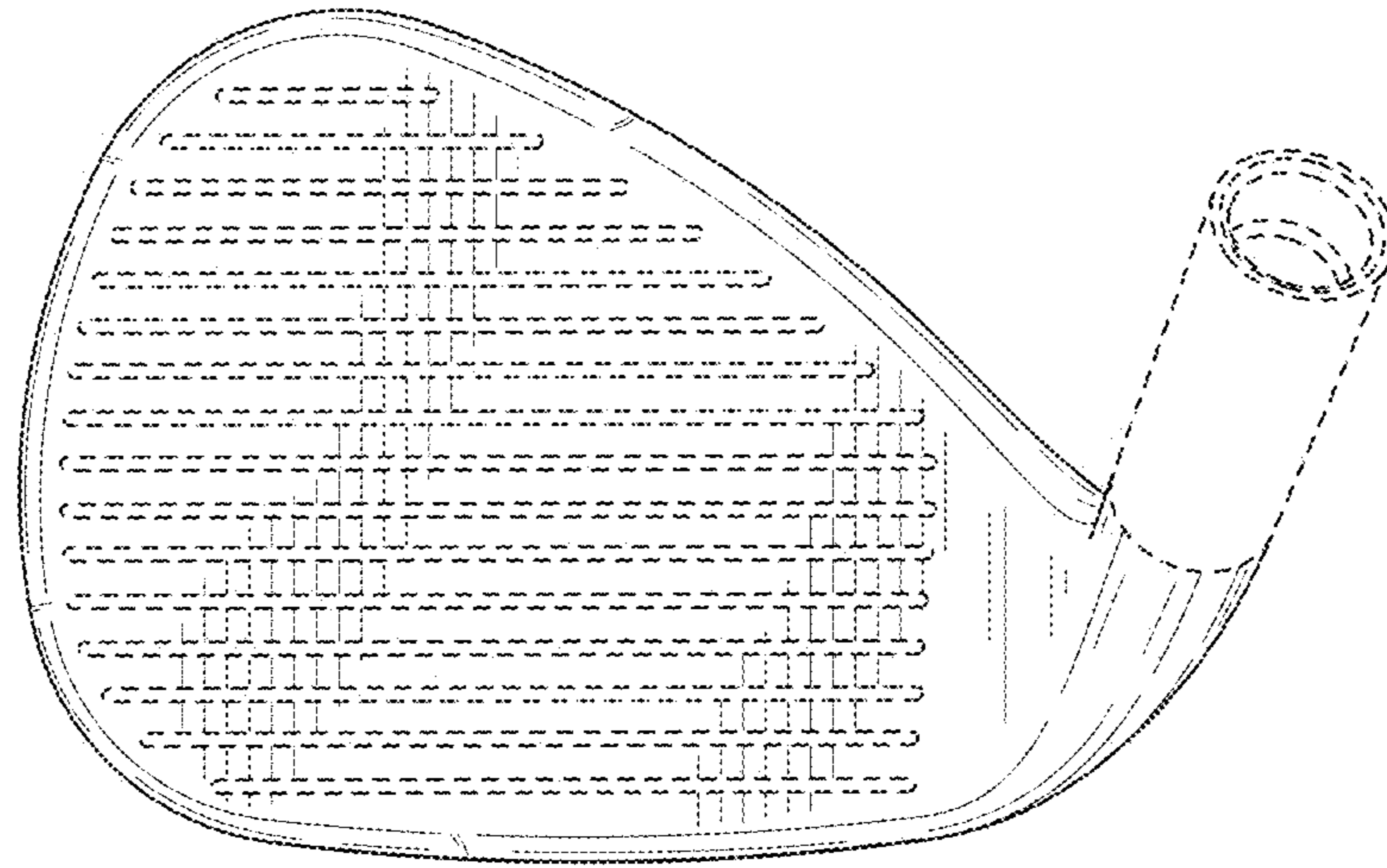
The ornamental design for a golf club head, as shown and described.

DESCRIPTION

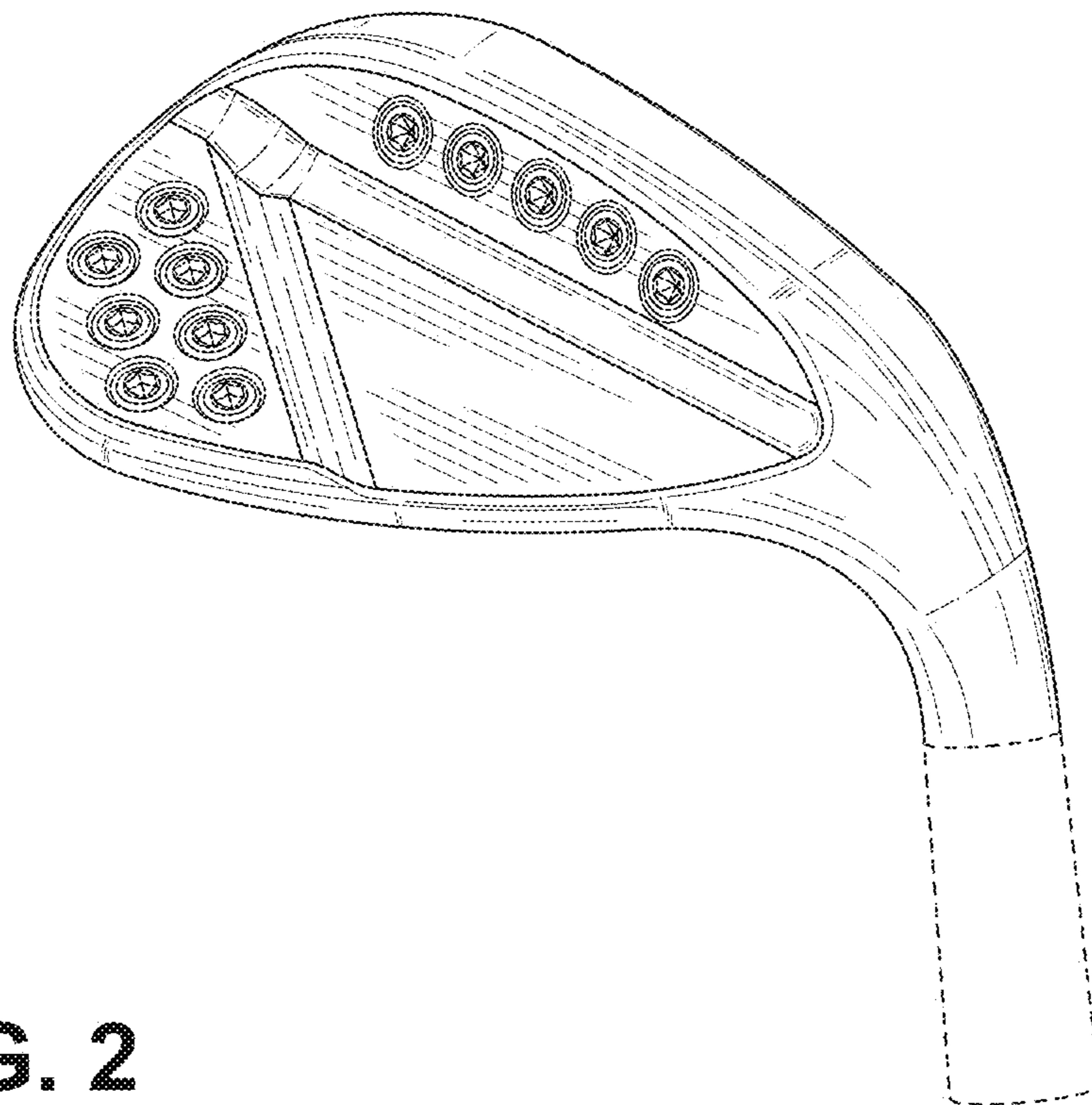
FIG. 1 is a top perspective view of a golf club head; FIG. 2 is a bottom perspective view of the golf club head of FIG. 1; FIG. 3 is a front elevational view of the golf club head of FIG. 1; FIG. 4 is a rear elevational view of the golf club head of FIG. 1; FIG. 5 is a top view of the golf club head of FIG. 1; FIG. 6 is a bottom view of the golf club head of FIG. 1; FIG. 7 is a left side view of the golf club head of FIG. 1; FIG. 8 is a right side view of the golf club head of FIG. 1; FIG. 9 is a top perspective view of a second embodiment of a golf club head; FIG. 10 is a bottom perspective view of the golf club head of FIG. 9; FIG. 11 is a front elevational view of the golf club head of FIG. 9; FIG. 12 is a rear elevational view of the golf club head of FIG. 9; FIG. 13 is a top view of the golf club head of FIG. 9; FIG. 14 is a bottom view of the golf club head of FIG. 9; FIG. 15 is a left side view of the golf club head of FIG. 9; FIG. 16 is a right side view of the golf club head of FIG. 9; FIG. 17 is a top perspective view of a third embodiment of a golf club head; FIG. 18 is a bottom perspective view of the golf club head of FIG. 17;

FIG. **19** is a front elevational view of the golf club head of FIG. **17**;  
FIG. **20** is a rear elevational view of the golf club head of FIG. **17**;  
FIG. **21** is a top view of the golf club head of FIG. **17**;  
FIG. **22** is a bottom view of the golf club head of FIG. **17**;  
FIG. **23** is a left side view of the golf club head of FIG. **17**;  
and,  
FIG. **24** is a right side view of the golf club head of FIG. **17**.  
The broken lines shown on the drawings forms no part of the claimed design.

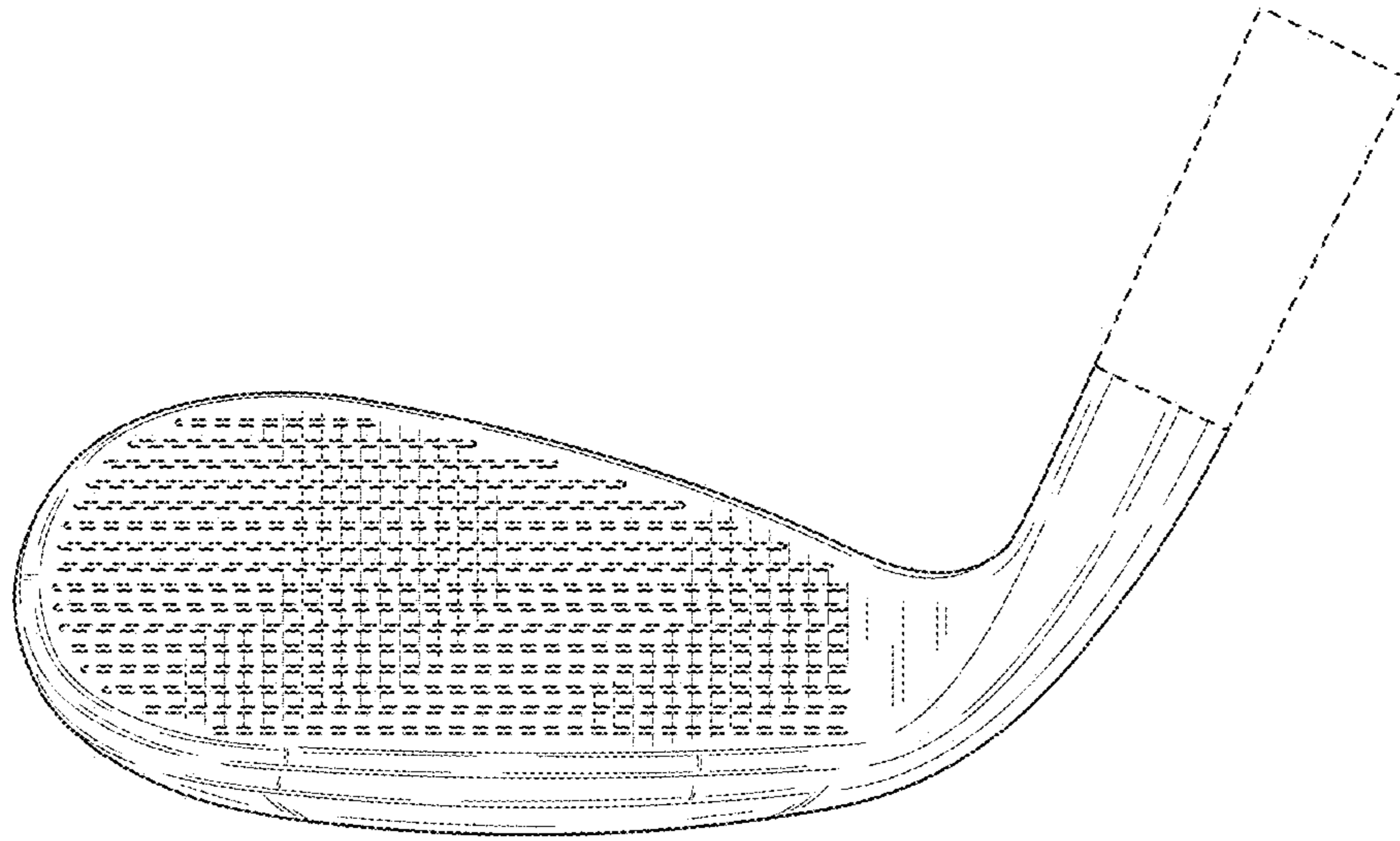
**1 Claim, 12 Drawing Sheets**



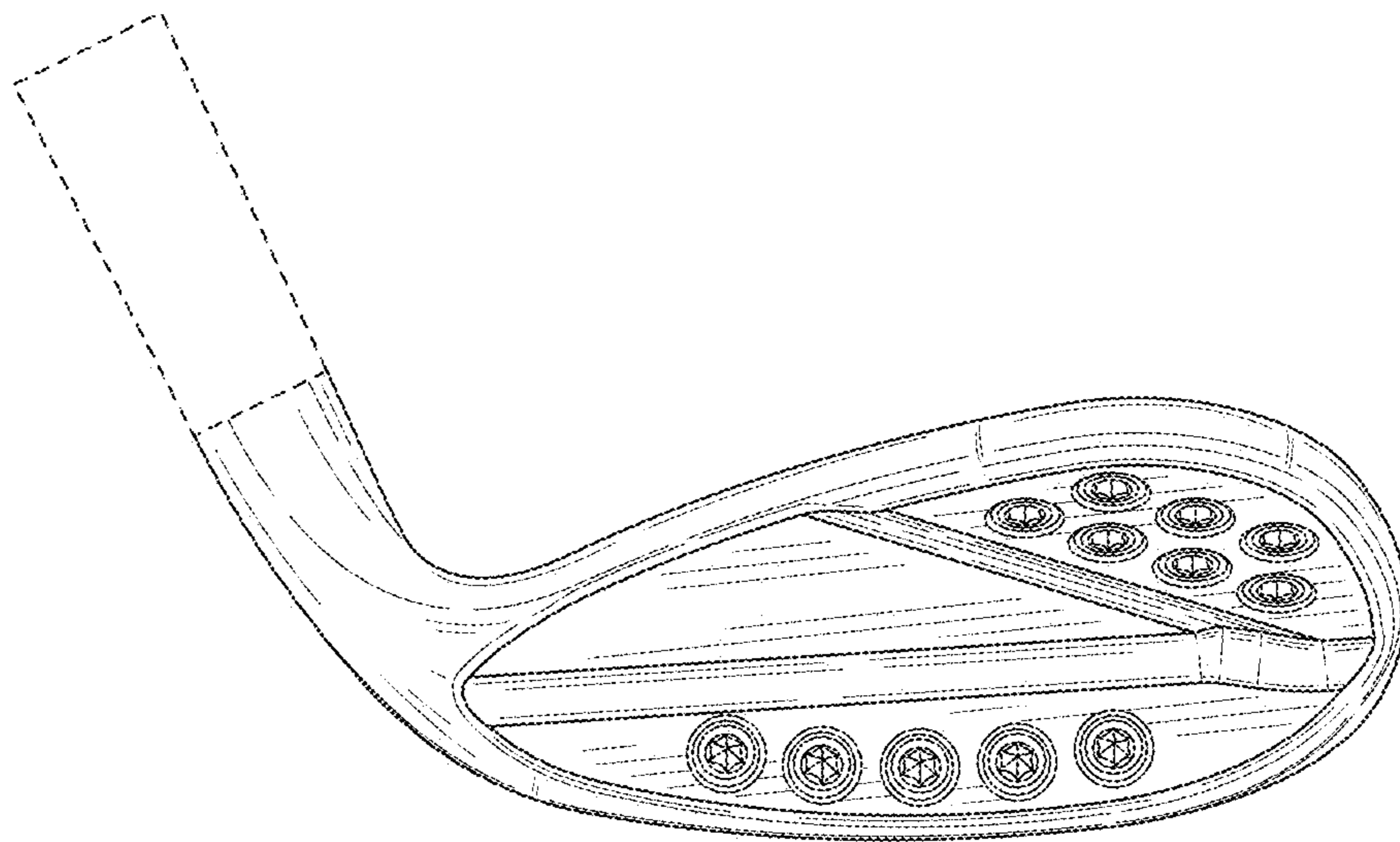
**FIG. 1**



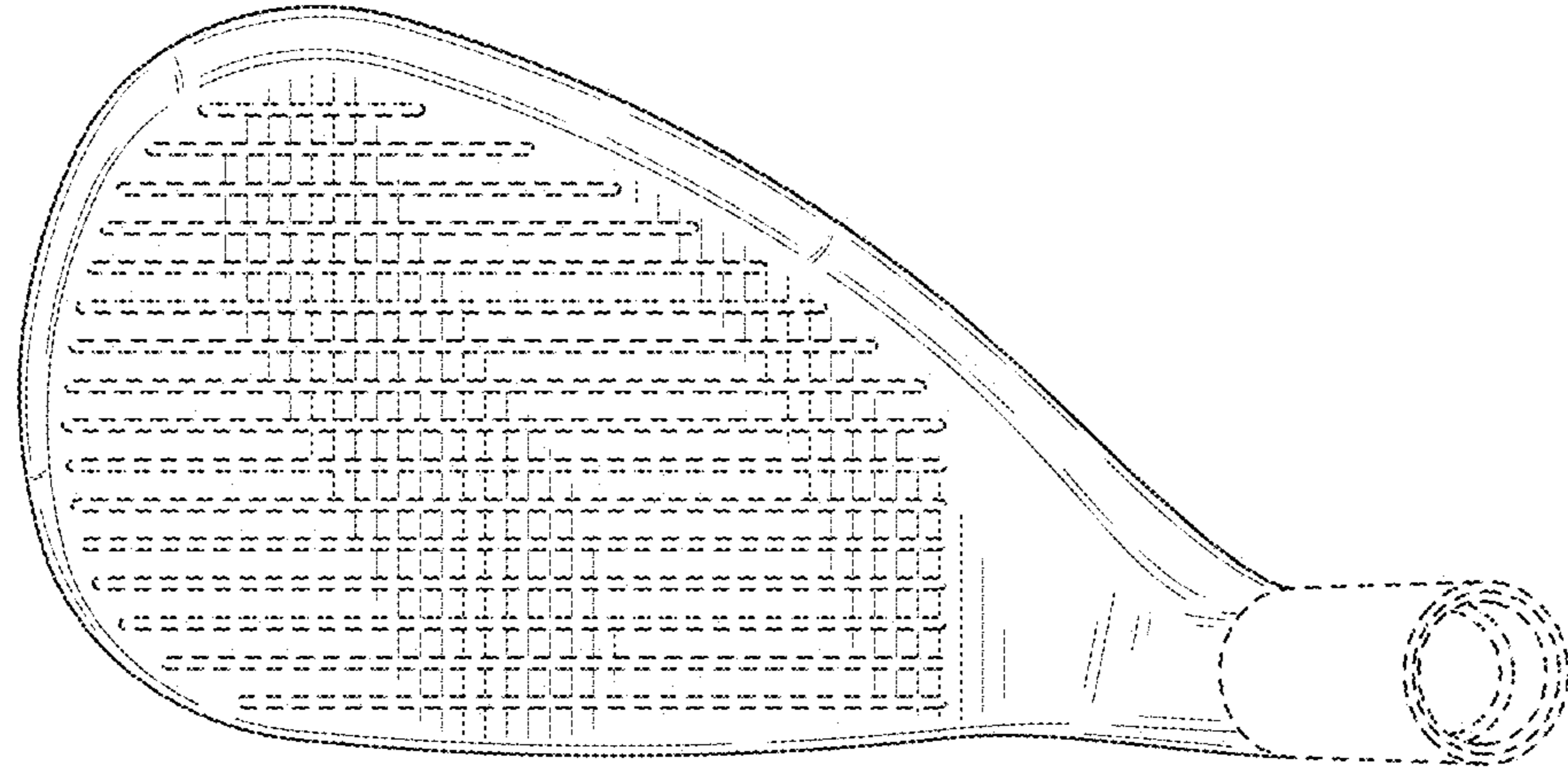
**FIG. 2**



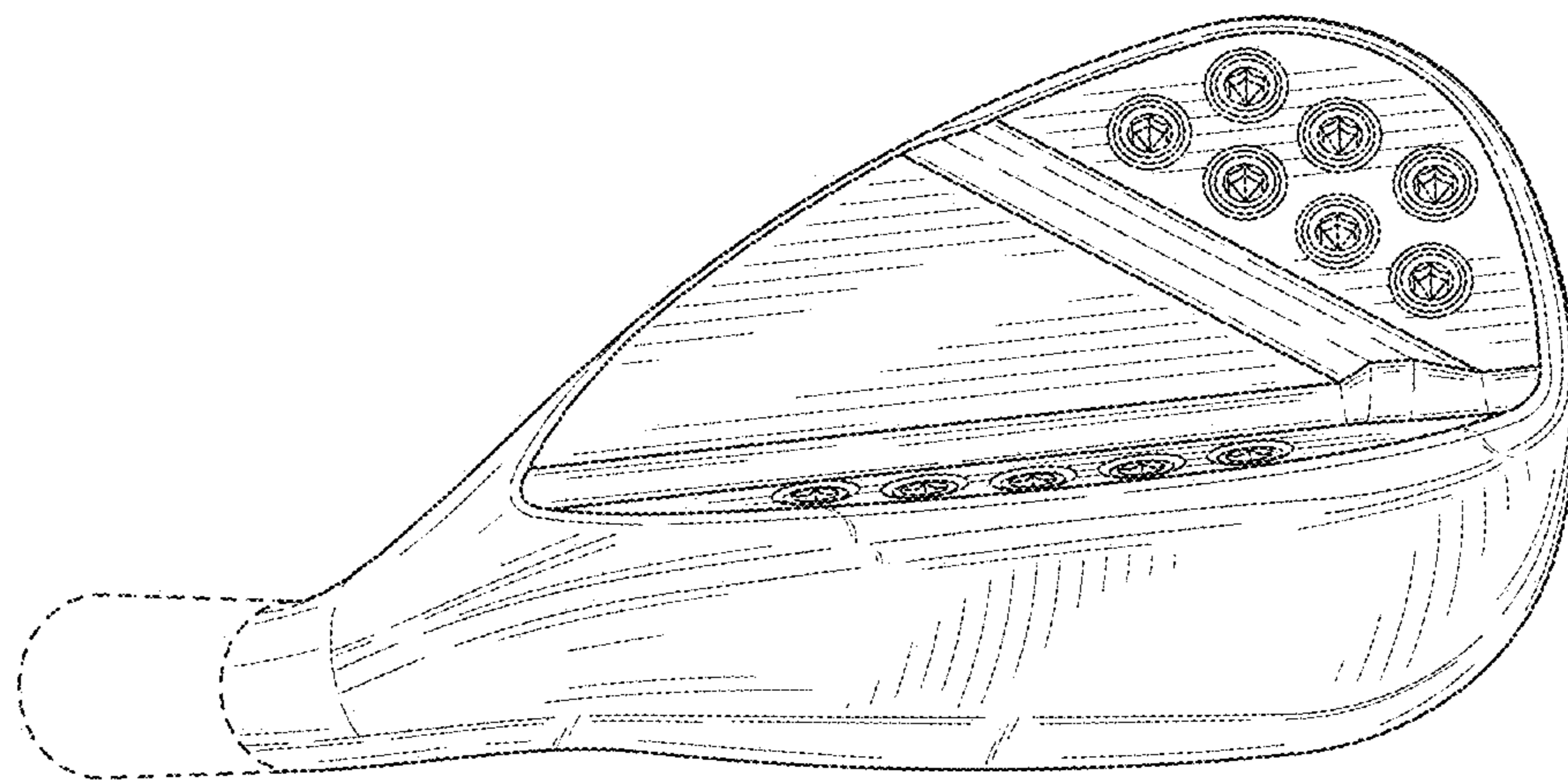
**FIG. 3**



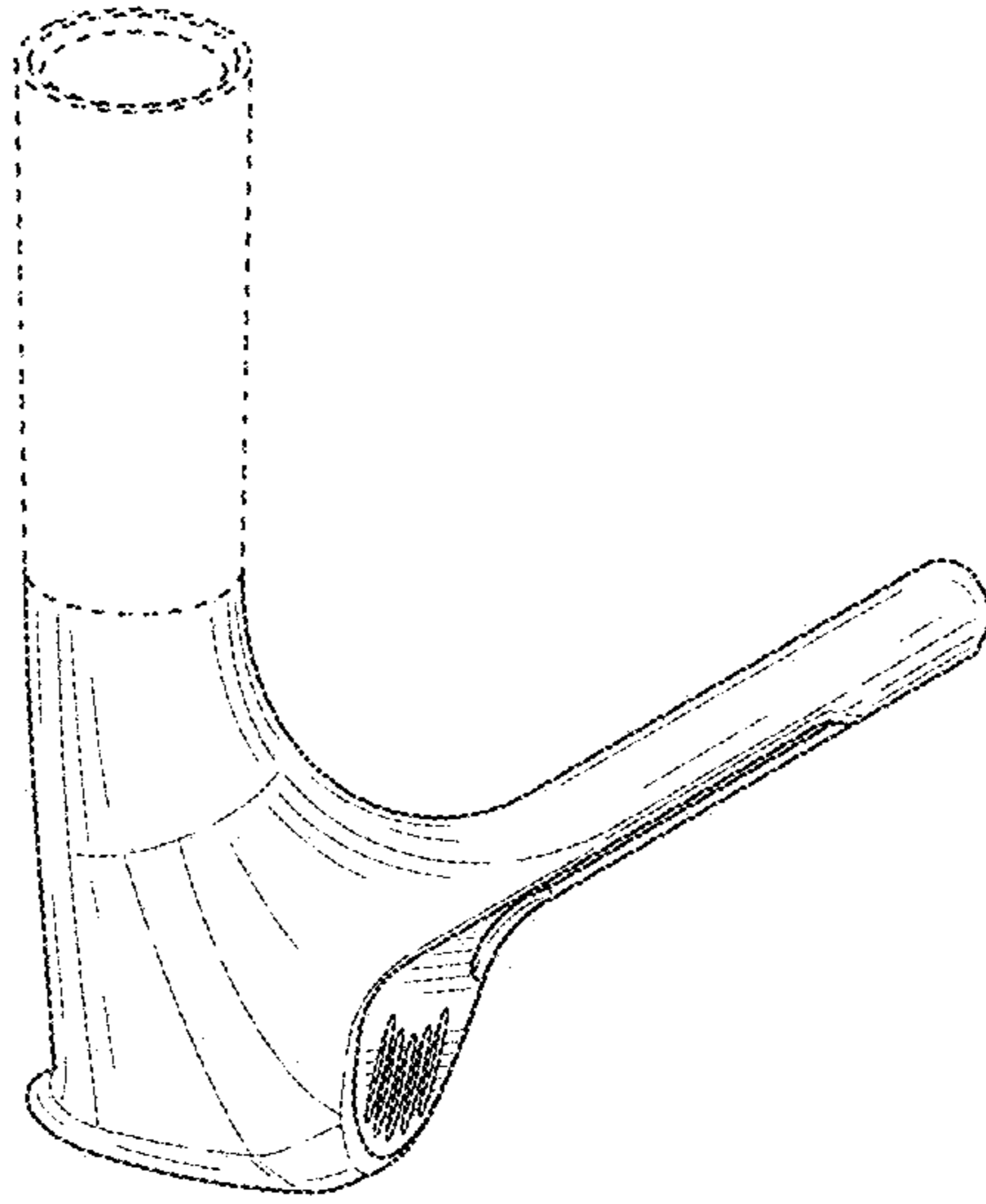
**FIG. 4**



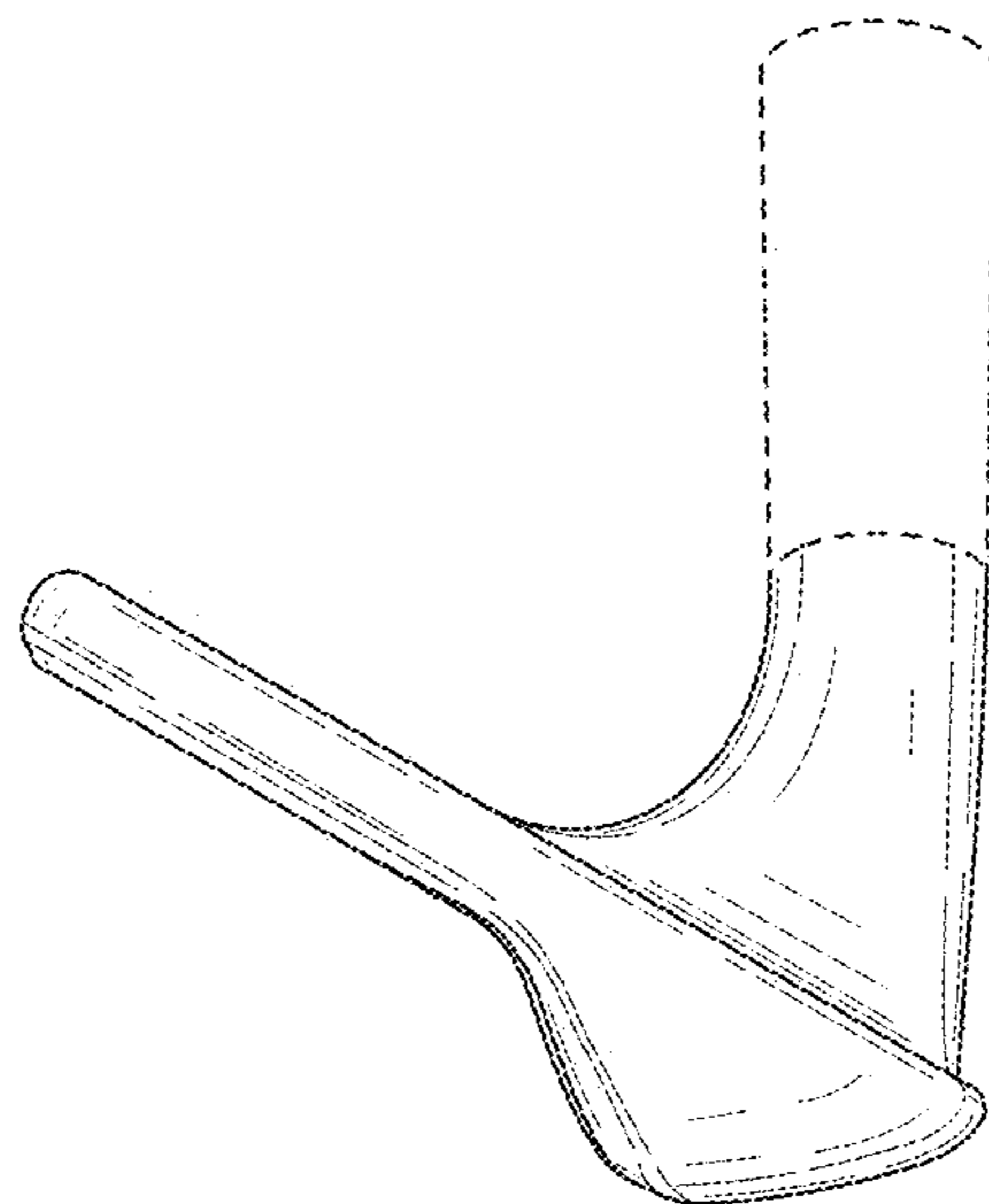
**FIG. 5**



**FIG. 6**

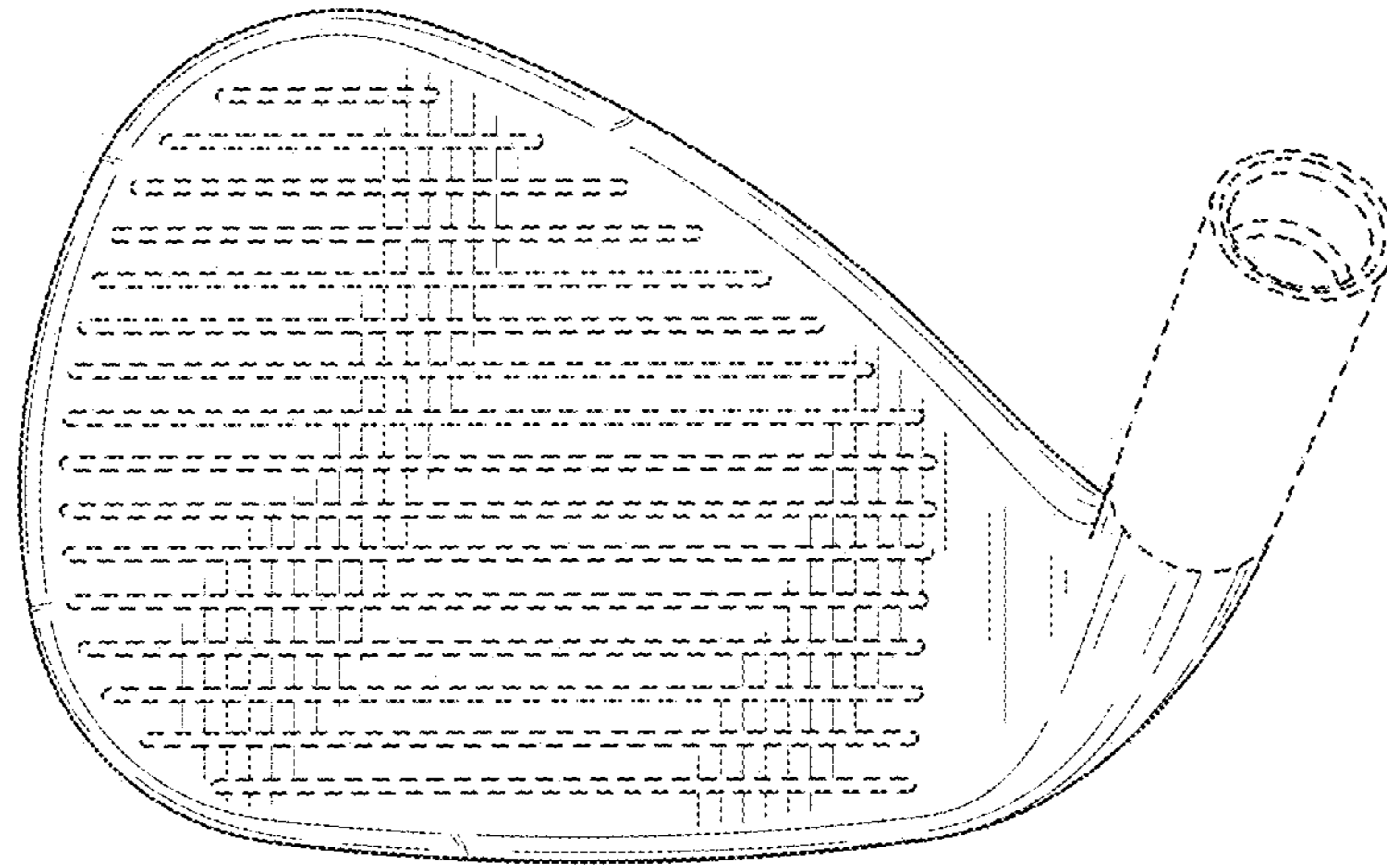


**FIG. 7**

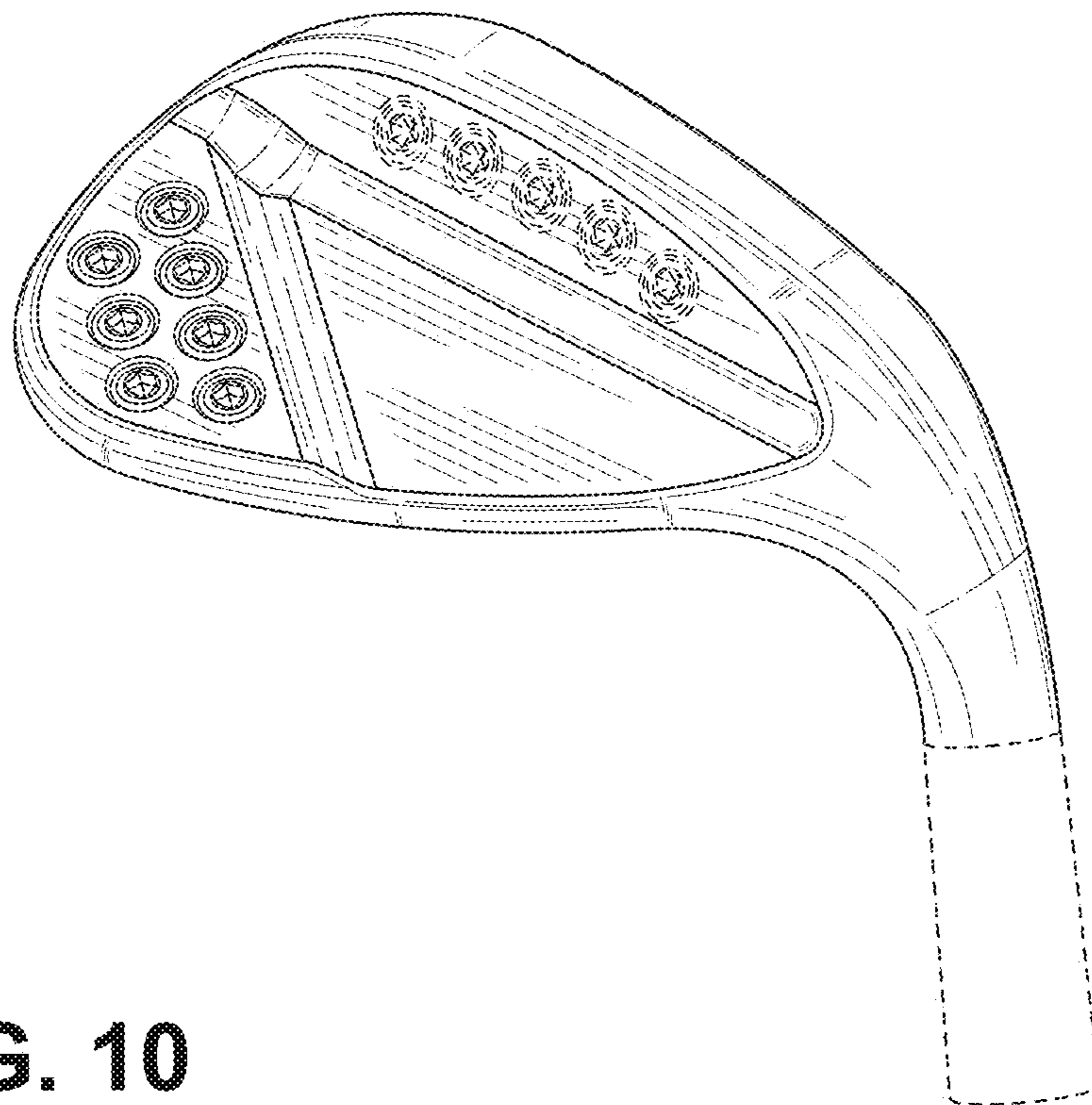


**FIG. 8**

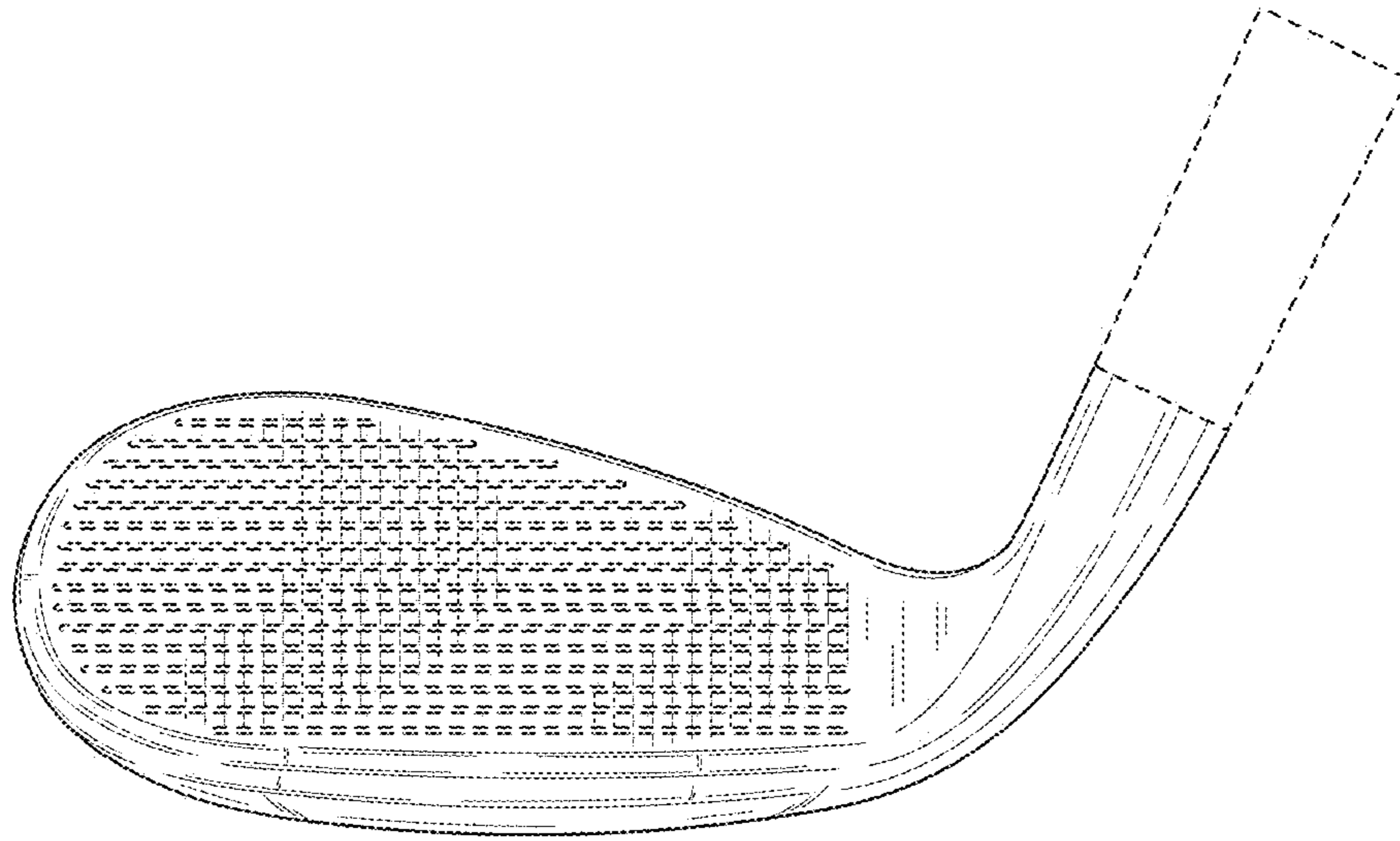




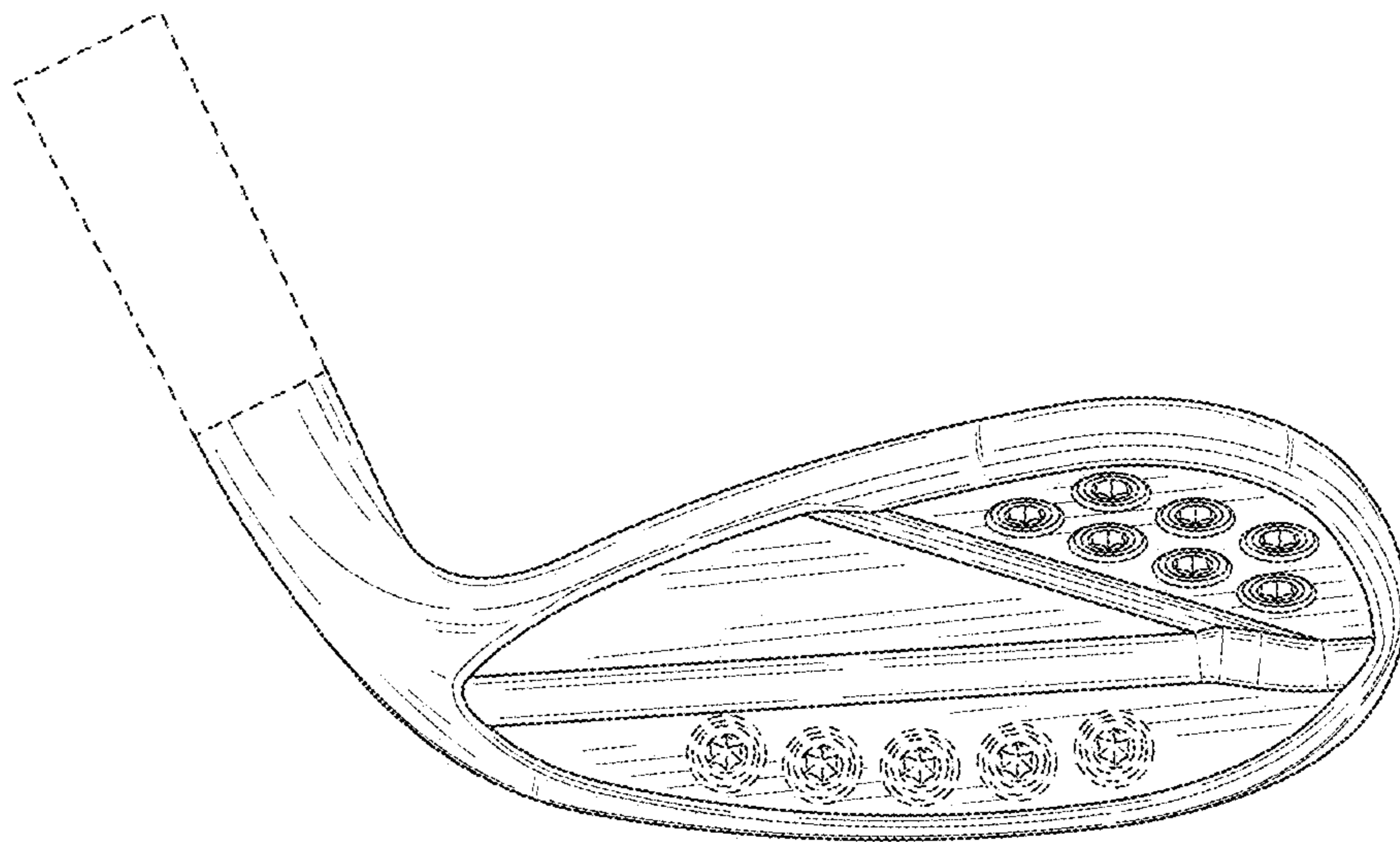
**FIG. 9**



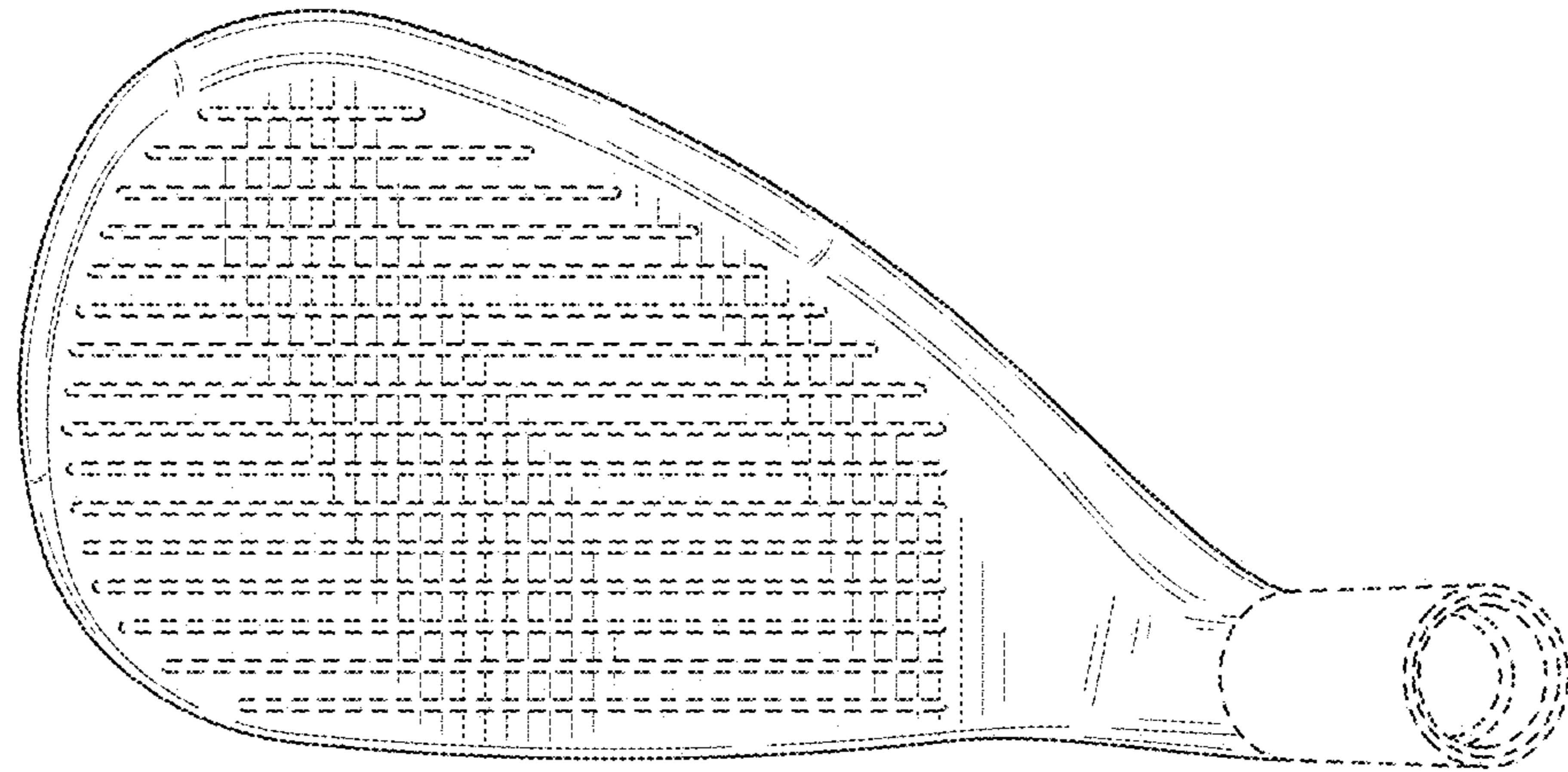
**FIG. 10**



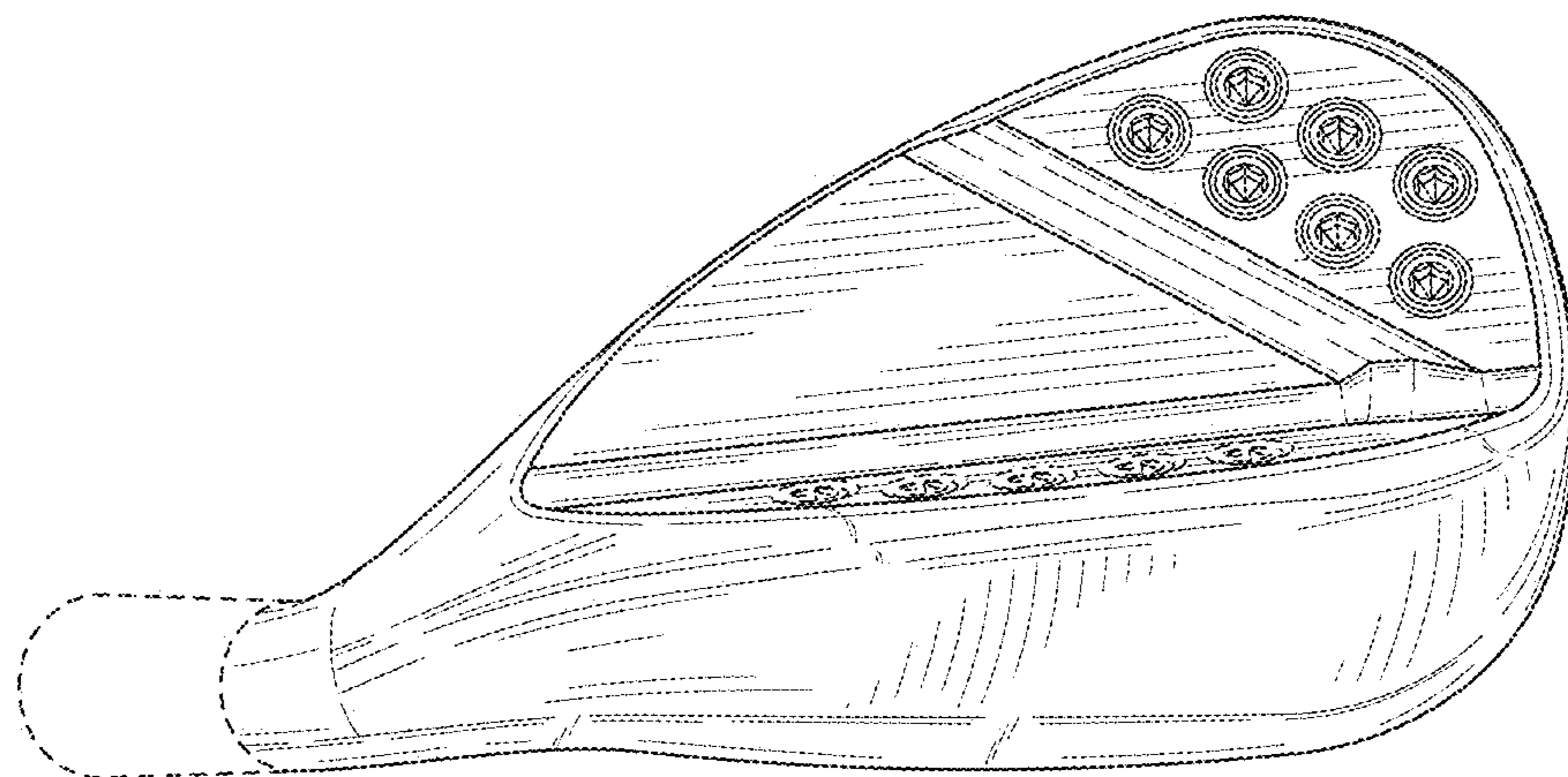
**FIG. 11**



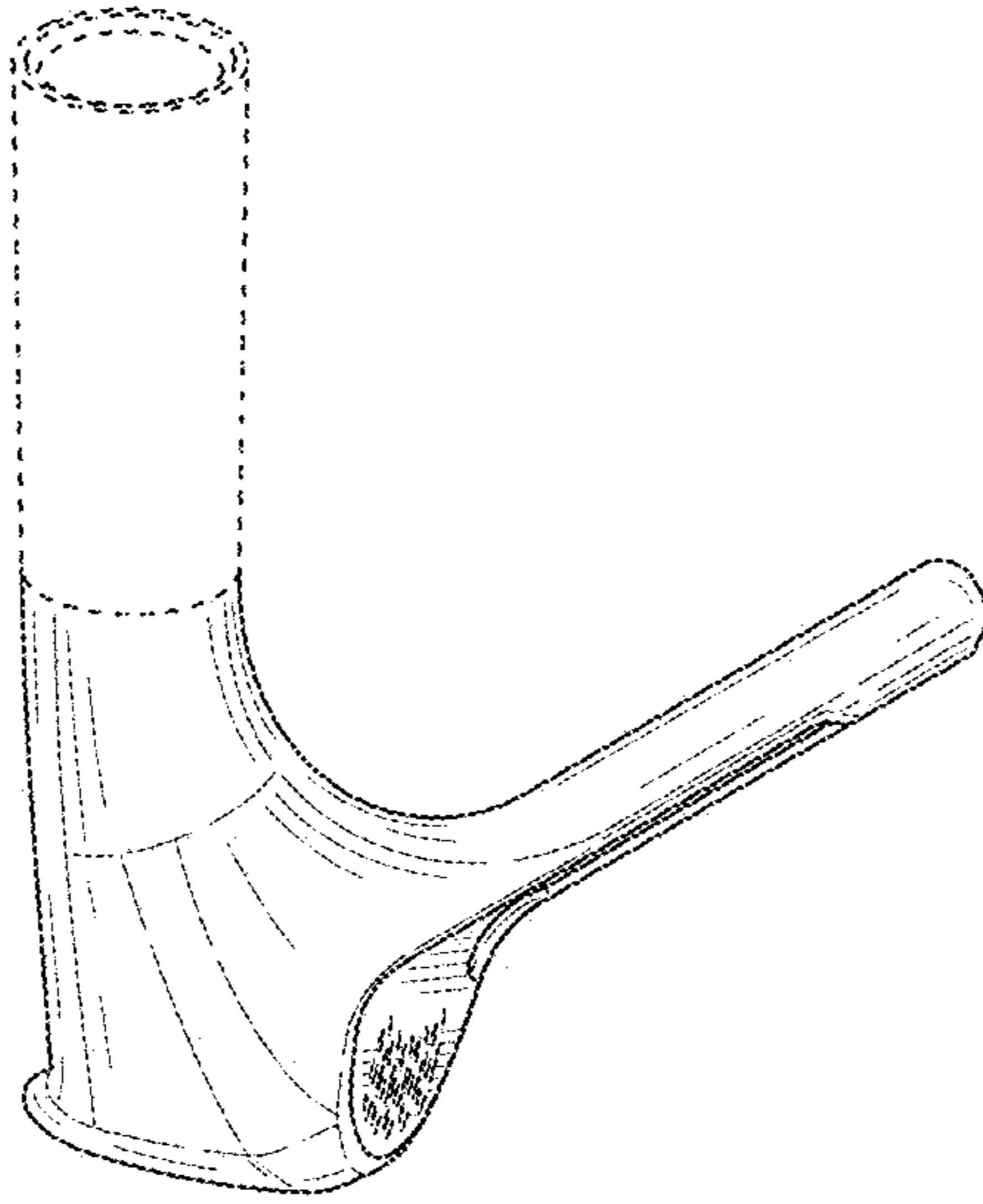
**FIG. 12**



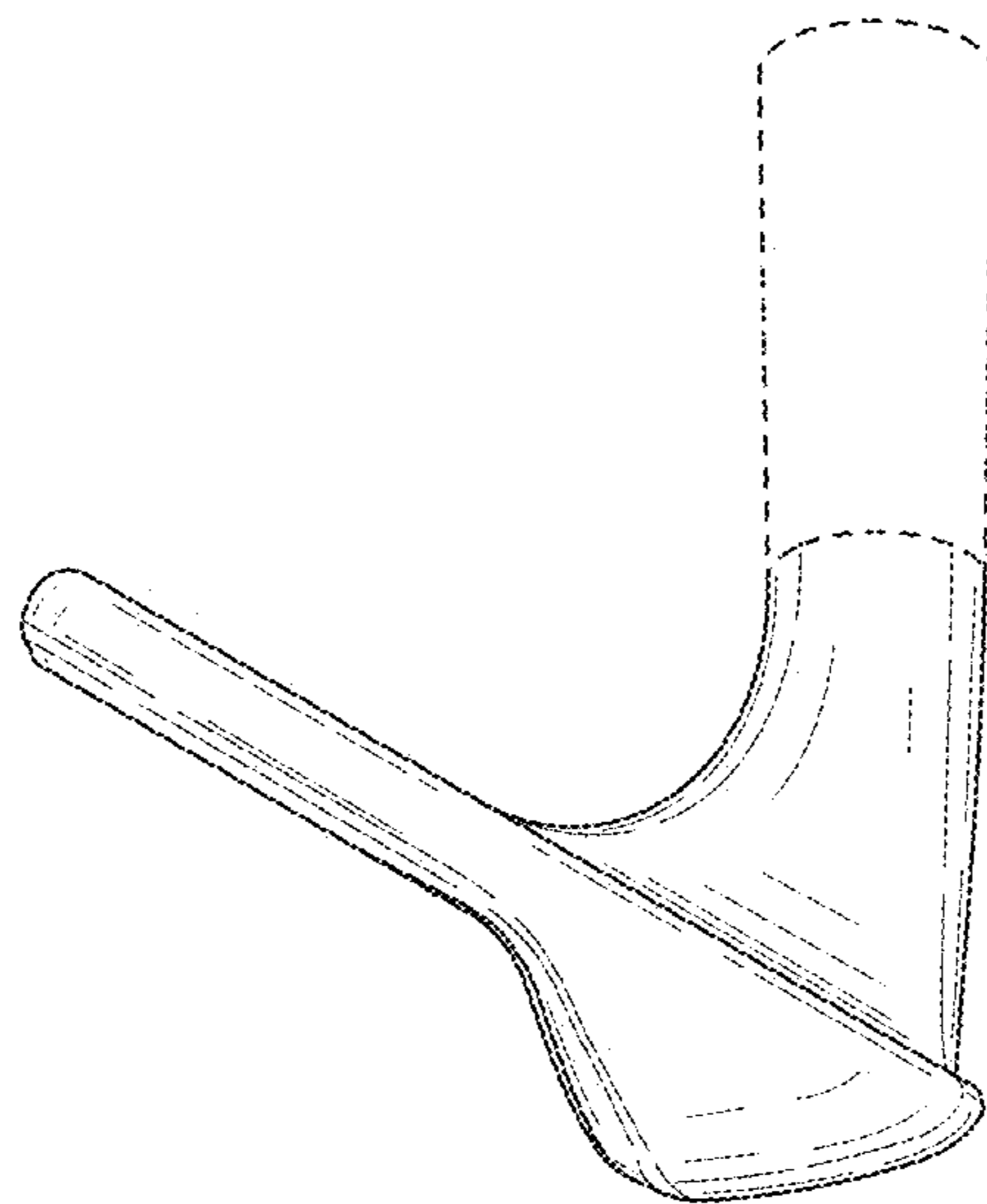
**FIG. 13**



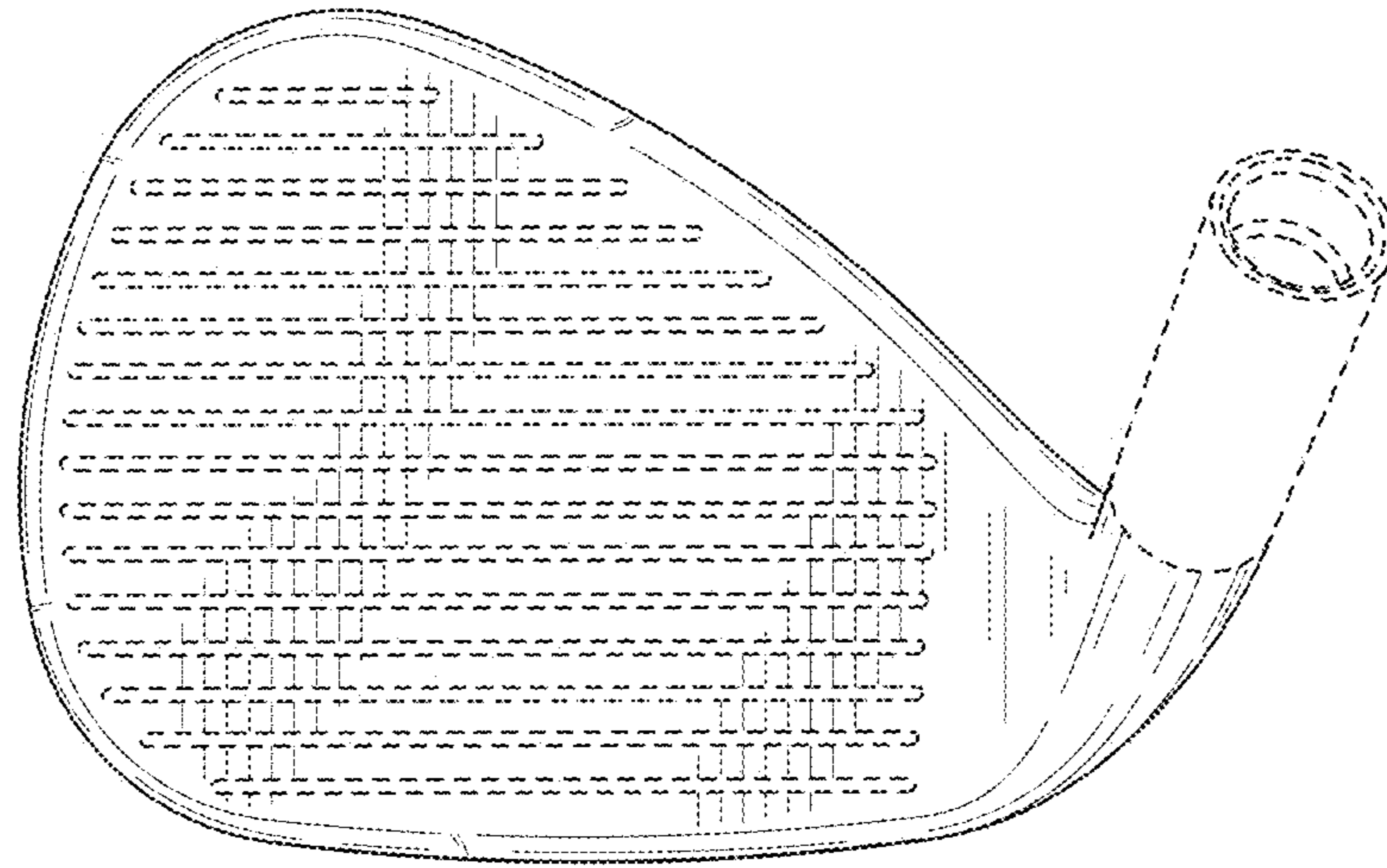
**FIG. 14**



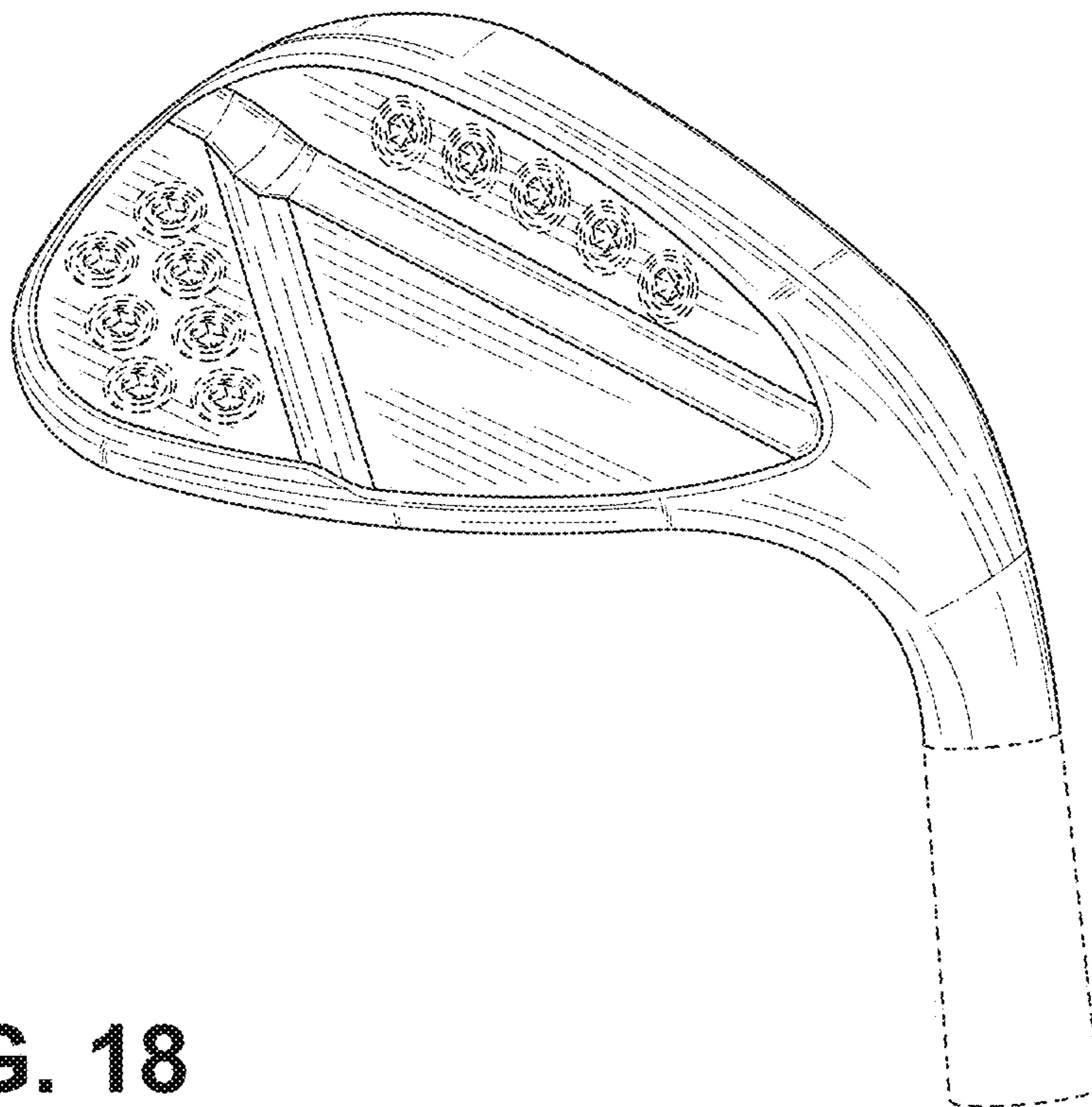
**FIG. 15**



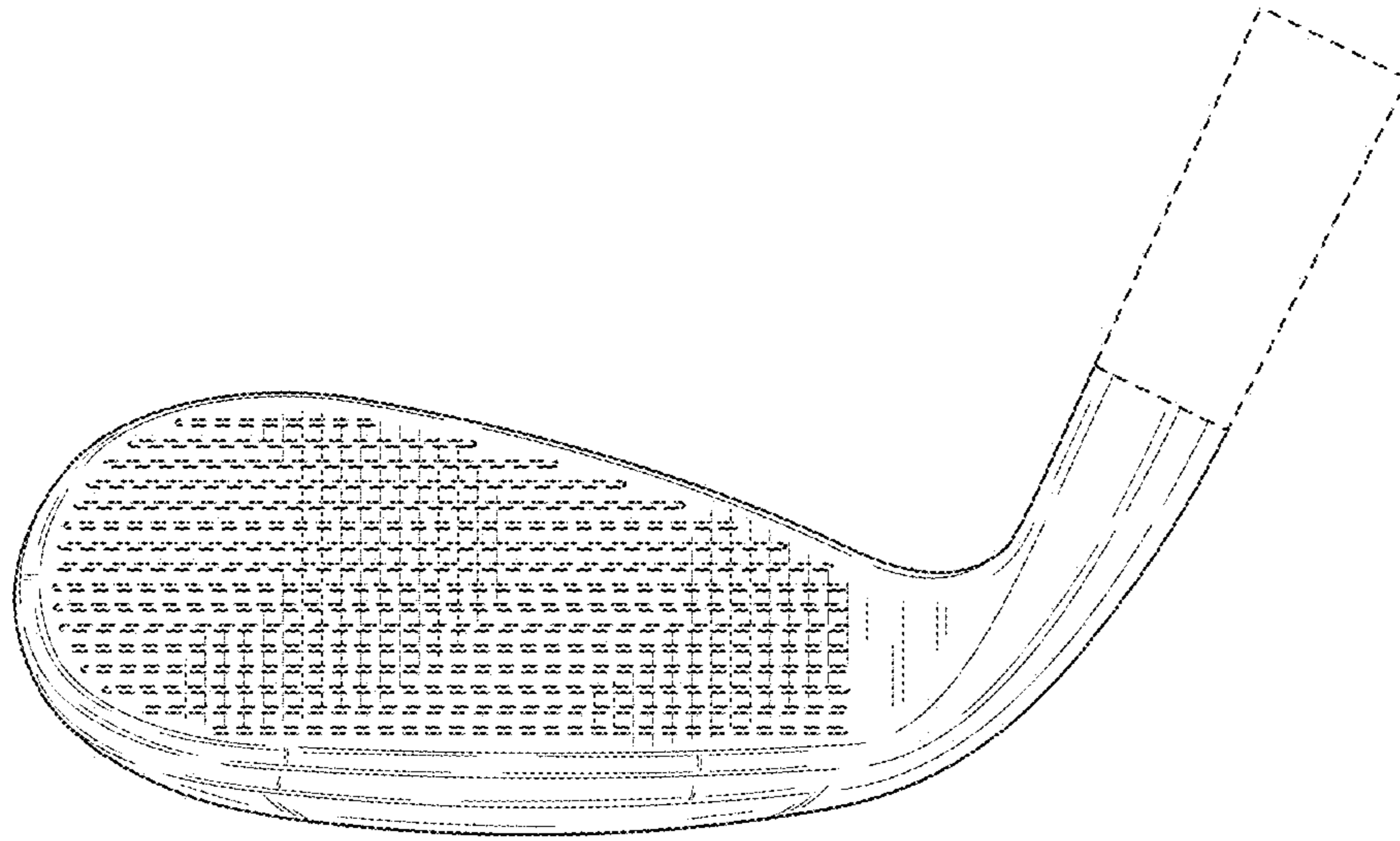
**FIG. 16**



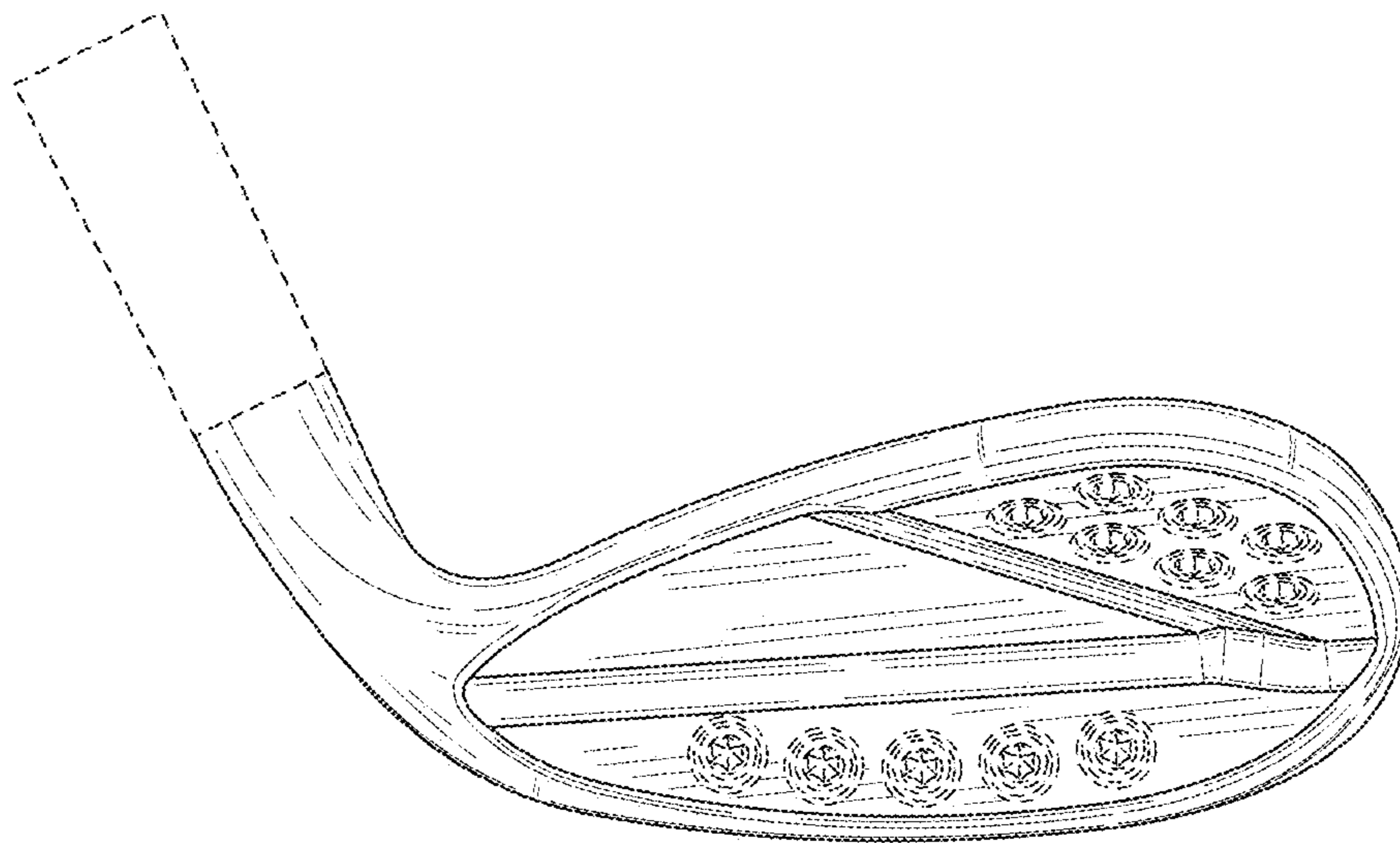
**FIG. 17**



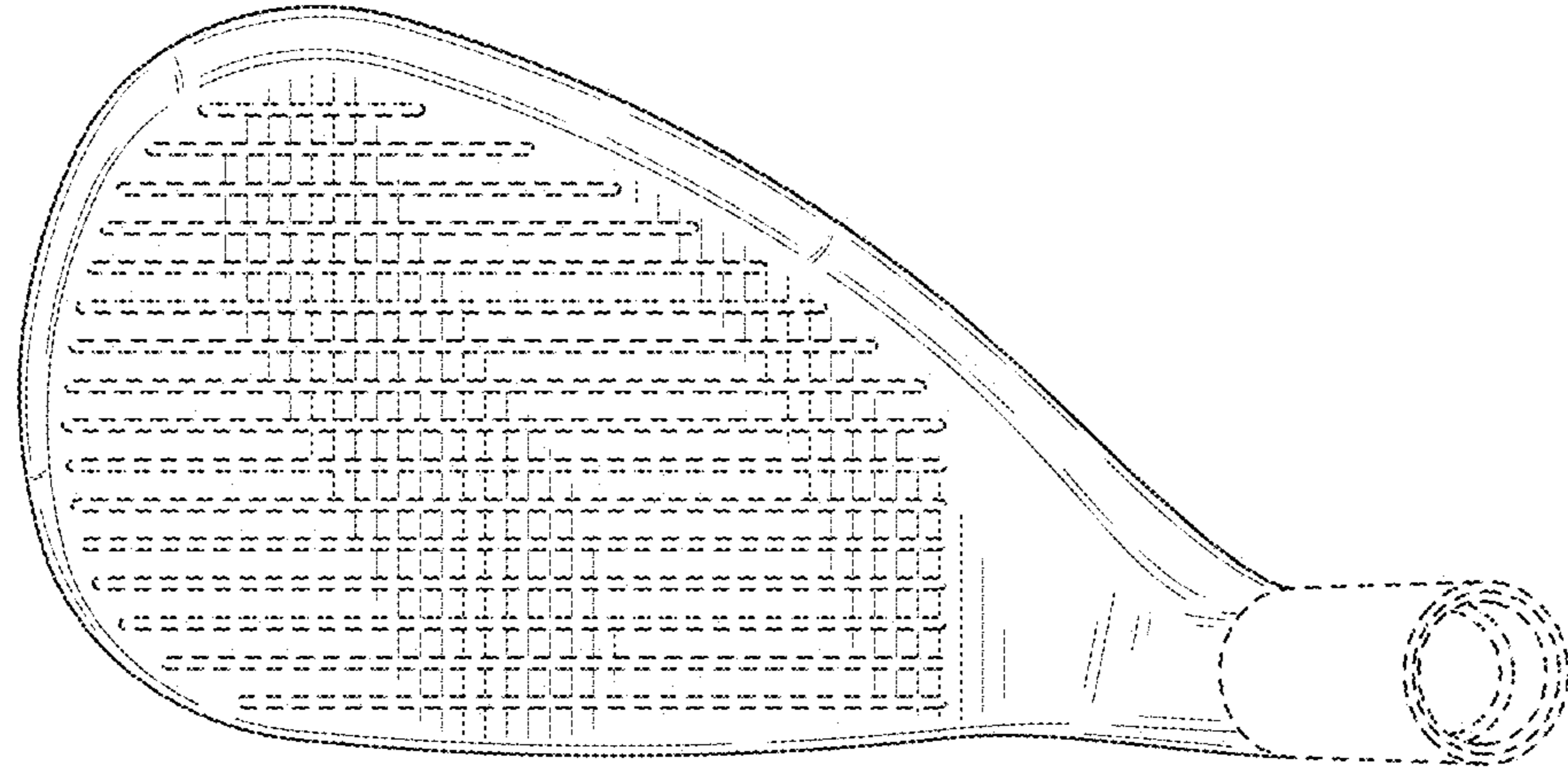
**FIG. 18**



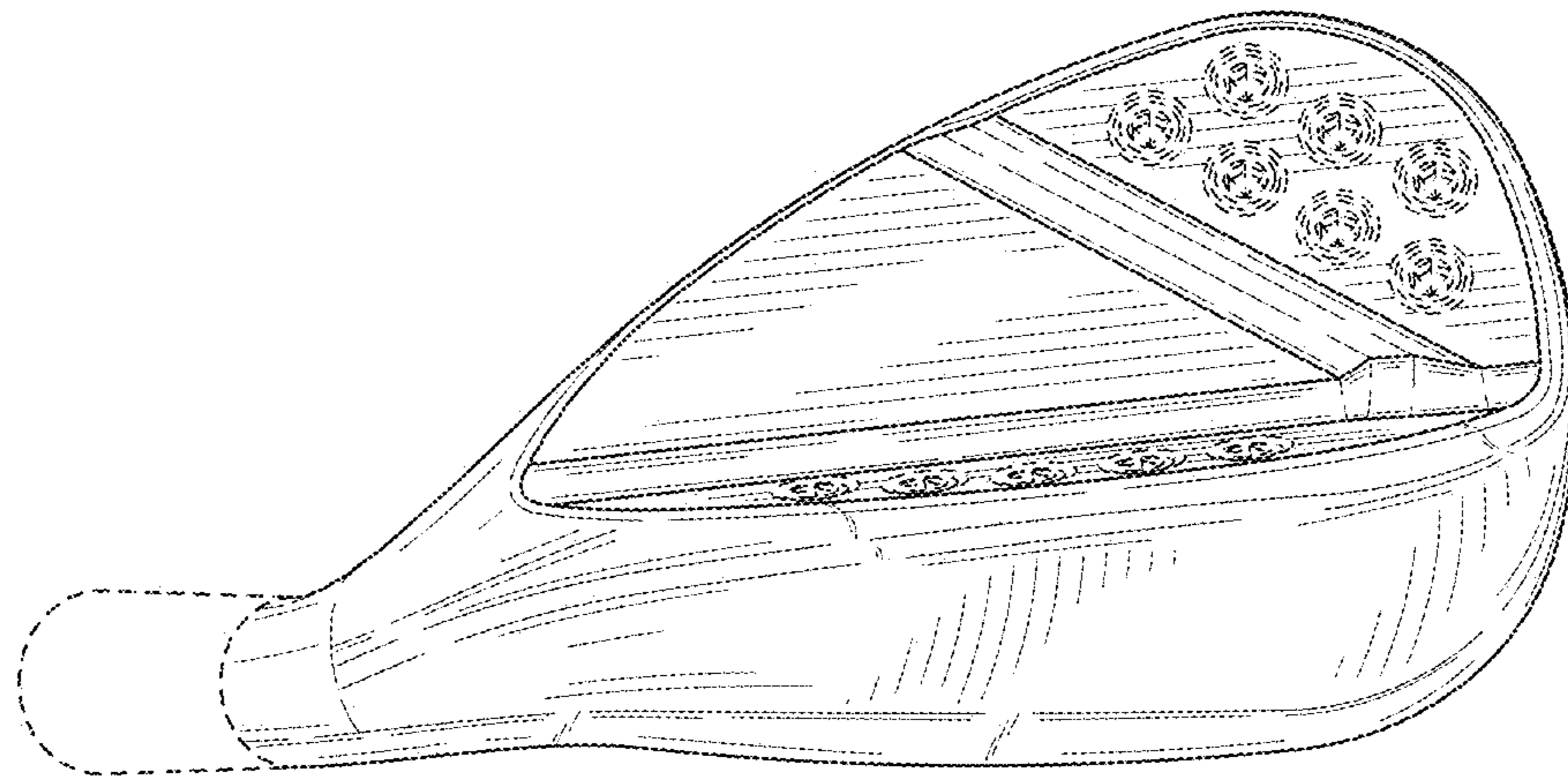
**FIG. 19**



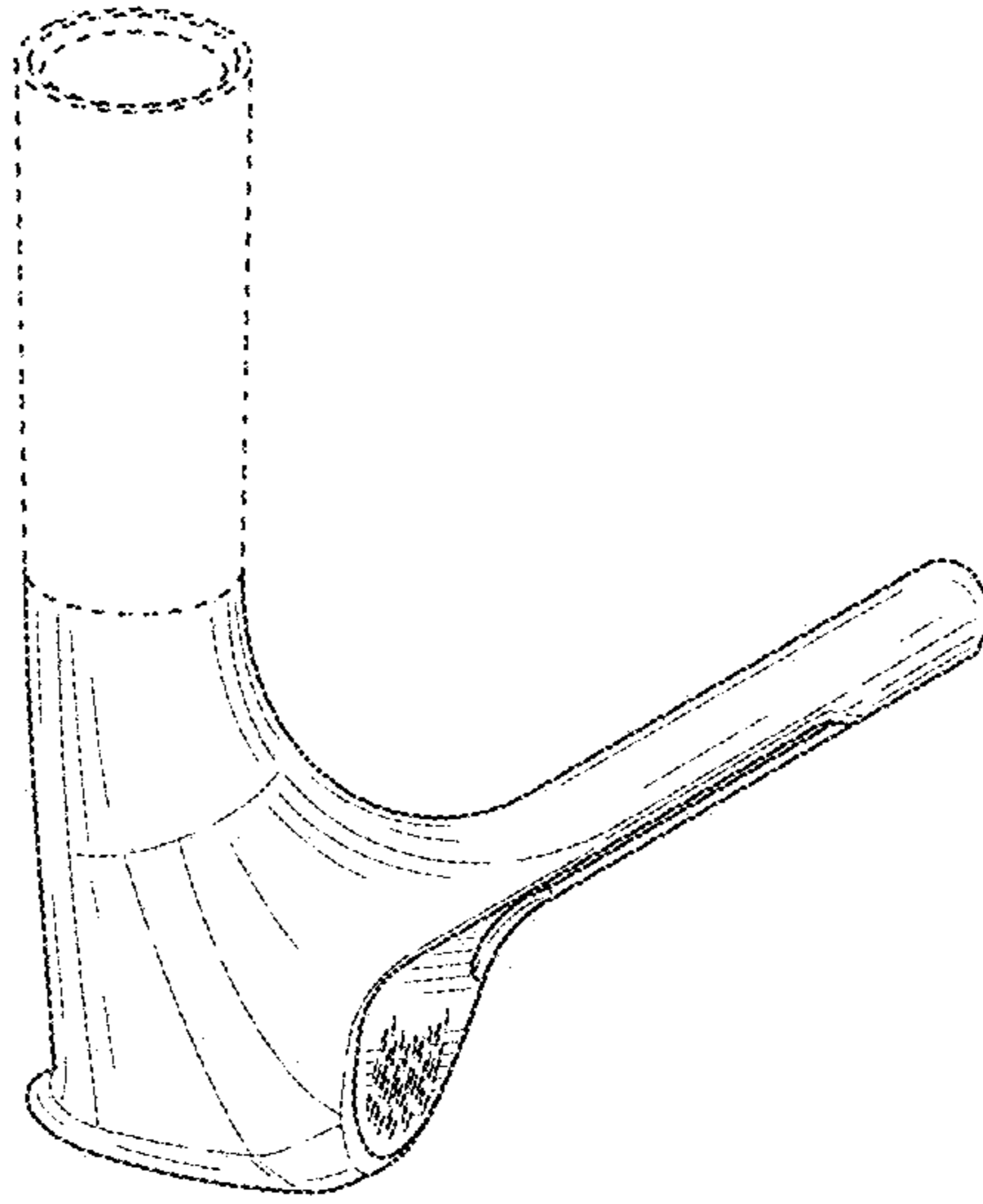
**FIG. 20**



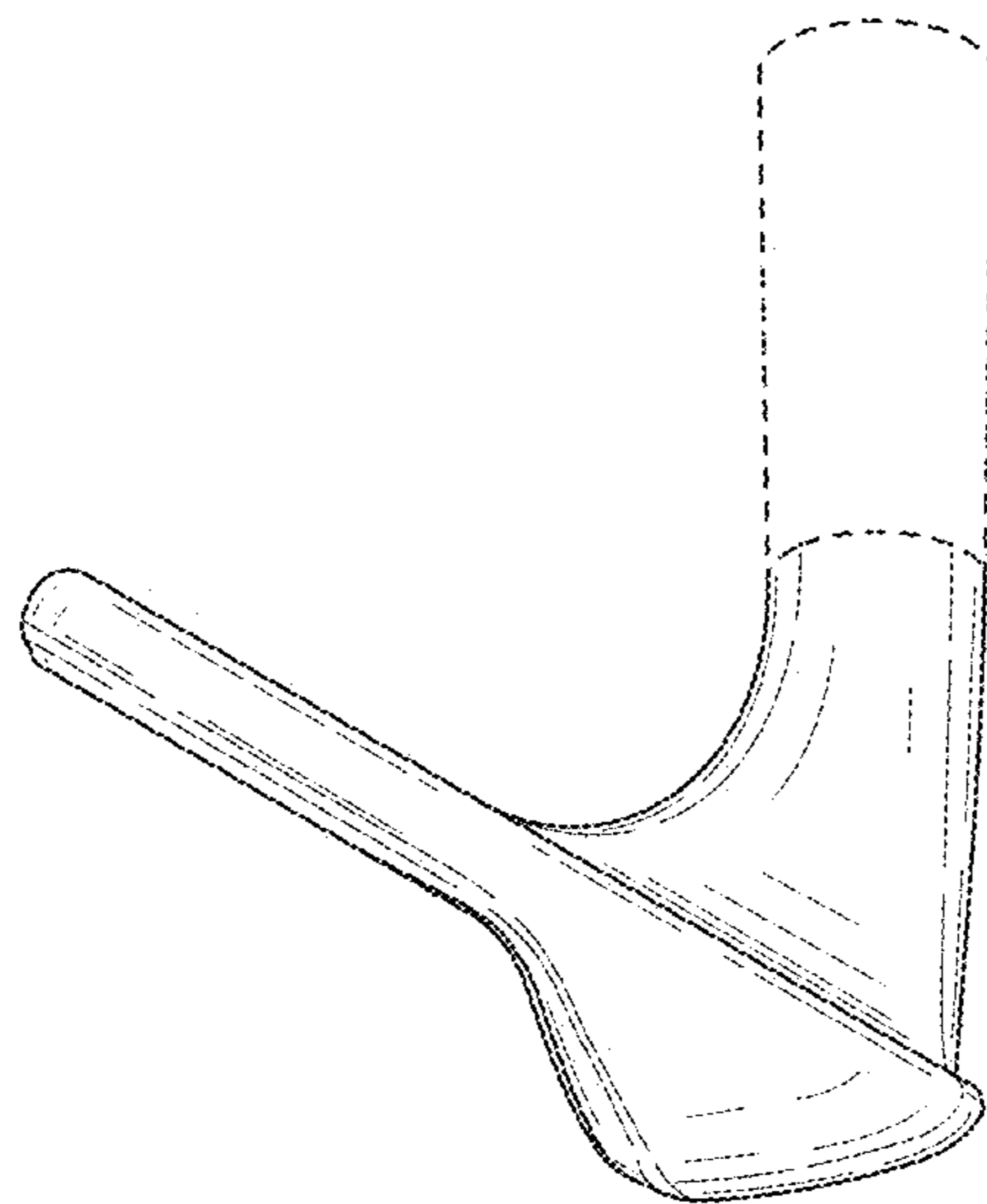
**FIG. 21**



**FIG. 22**



**FIG. 23**



**FIG. 24**