



US00D926898S

(12) **United States Design Patent** (10) **Patent No.:** **US D926,898 S**
Schweigert et al. (45) **Date of Patent:** **** Aug. 3, 2021**

(54) **GOLF CLUB HEAD**
 (71) Applicant: **PARSONS XTREME GOLF, LLC**,
 Scottsdale, AZ (US)
 (72) Inventors: **Bradley D. Schweigert**, Cave Creek,
 AZ (US); **Michael R. Nicolette**,
 Scottsdale, AZ (US)
 (73) Assignee: **PARSONS XTREME GOLF, LLC**,
 Scottsdale, AZ (US)
 (**) Term: **15 Years**
 (21) Appl. No.: **29/701,164**
 (22) Filed: **Aug. 8, 2019**

Related U.S. Application Data

(63) Continuation-in-part of application No. 29/692,725,
 filed on May 28, 2019, now abandoned.
 (51) **LOC (13) Cl.** **21-02**
 (52) **U.S. Cl.**
 USPC **D21/736**
 (58) **Field of Classification Search**
 USPC D21/736-746
 CPC A63B 53/00; A63B 53/04; A63B 53/007;
 A63B 53/065; A63B 53/0487; A63B
 60/00; A63B 60/46
 See application file for complete search history.

References Cited

U.S. PATENT DOCUMENTS

723,534 A * 3/1903 Knight A63B 53/0487
 473/313
 D57,980 S * 5/1921 Kraeuter D21/741
 RE19,178 E 5/1934 Spiker
 4,043,562 A 8/1977 Shillington
 D248,783 S 8/1978 Long
 D281,092 S 10/1985 Mills
 4,754,977 A 7/1988 Sahn
 4,869,507 A 9/1989 Sahn
 D313,451 S 1/1991 Shearer
 D335,317 S 5/1993 Shearer

D335,692 S 5/1993 Antonious
 D336,757 S 6/1993 Antonious
 D350,582 S 9/1994 Miansian et al.
 5,390,919 A 2/1995 Stubbs
 5,429,366 A 7/1995 McCabe
 D363,101 S 10/1995 Sturm
 5,489,097 A 2/1996 Simmons
 D368,751 S 4/1996 Rife
 D369,393 S 4/1996 Oku
 D365,864 S 10/1996 Strum
 5,571,053 A 11/1996 Lane
 D378,688 S 4/1997 Cameron, Jr.
 D380,514 S 7/1997 Markley
 D385,609 S 10/1997 Cameron
 5,683,307 A 11/1997 Rife
 D388,143 S 12/1997 Huan-Chiang
 D389,207 S 1/1998 Cameron
 D396,083 S * 7/1998 Sheets D21/742
 D398,685 S 9/1998 Masuda
 D399,290 S 10/1998 Sizemore, Jr.
 D399,911 S 10/1998 Sanchez
 D400,610 S * 11/1998 Cameron D21/742
 5,839,974 A 11/1998 McAllister
 D405,836 S 2/1999 Nicolette et al.
 D409,701 S 5/1999 Ashcraft et al.
 5,924,938 A 7/1999 Hines
 D422,655 S 4/2000 Hicks
 D426,276 S 6/2000 Besnard et al.
 D428,457 S * 7/2000 Rollinson D21/743
 D431,854 S 10/2000 Cameron
 D432,192 S 10/2000 Hicks
 D436,151 S 1/2001 Nicolette et al.
 D437,374 S 2/2001 Cameron
 D441,820 S 5/2001 Nicolette et al.
 D443,668 S 6/2001 Nicolette et al.
 D443,905 S 6/2001 Nicolette et al.
 D444,833 S 7/2001 Nicolette
 6,264,571 B1 7/2001 Lekavich
 D449,664 S 10/2001 Beebe et al.
 D449,865 S 10/2001 Fife, Jr. et al.
 D450,799 S 11/2001 Nicolette et al.
 D451,973 S 12/2001 Wells et al.
 6,348,014 B1 2/2002 Chiu
 6,354,959 B1 3/2002 Nicolette
 6,394,910 B1 5/2002 McCarthy
 D472,949 S 4/2003 Serrano
 D474,821 S 5/2003 Wells et al.
 D483,086 S 12/2003 Schweigert
 D486,872 S 2/2004 Schweigert et al.
 D496,276 S 11/2004 Schweigert et al.
 D500,823 S * 1/2005 Aldrich D21/759
 6,902,496 B2 6/2005 Solheim
 D511,801 S 11/2005 Garcia

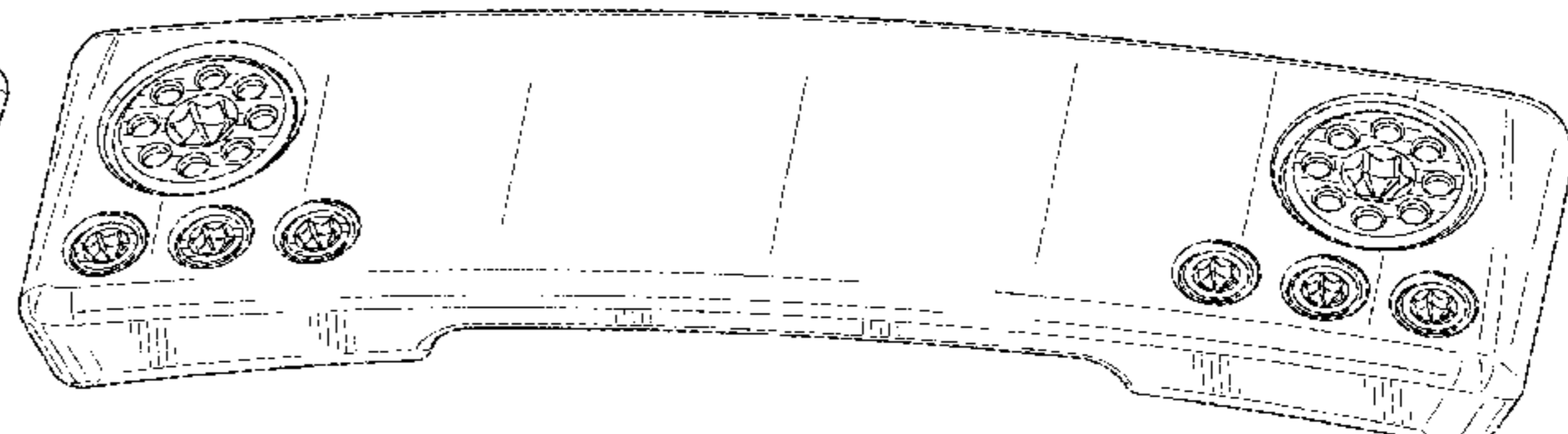
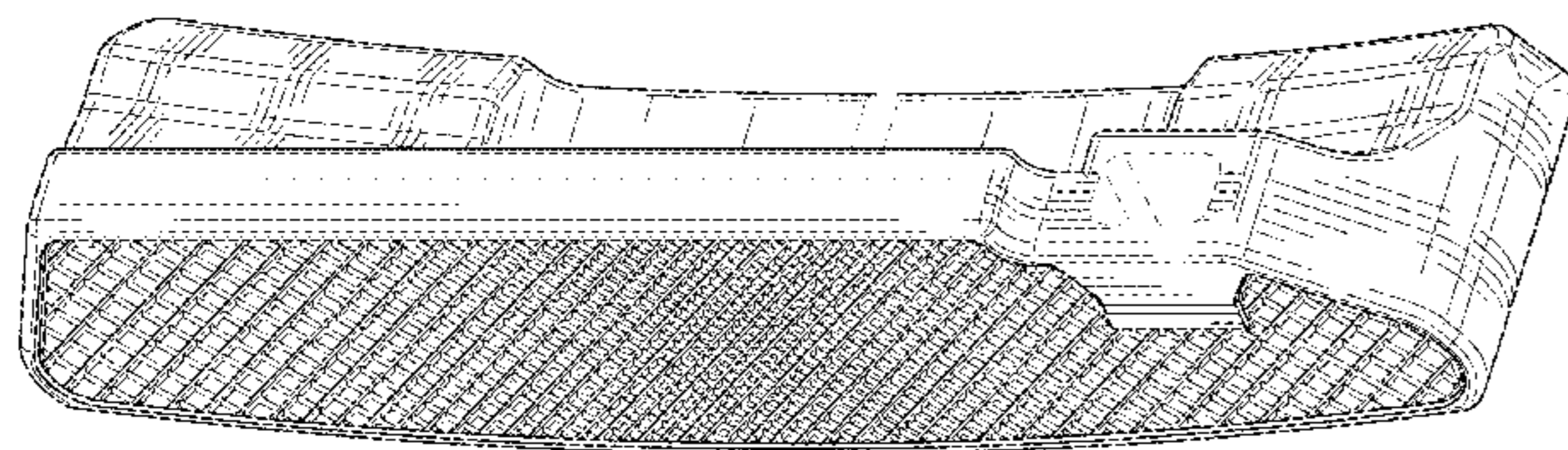

US D926,898 S

D511,802 S *	11/2005	Cameron	D21/744	D720,412 S *	12/2014	Rollinson	D21/743
D512,114 S	11/2005	Garcia		D722,350 S	2/2015	Schweigert	
D512,116 S	11/2005	Mirafior et al.		D722,351 S	2/2015	Parsons et al.	
6,988,956 B2	1/2006	Cover		D722,352 S	2/2015	Nicolette et al.	
D520,088 S	5/2006	Farr		D723,120 S	2/2015	Nicolette	
D531,242 S	10/2006	Adams		D724,164 S	3/2015	Schweigert et al.	
D532,067 S	11/2006	Soracco		D725,208 S *	3/2015	Schweigert	D21/743
D532,468 S *	11/2006	Hettinger	D21/743	D726,265 S	4/2015	Nicolette	
7,153,220 B2	12/2006	Lo		D726,846 S *	4/2015	Schweigert	D21/743
D534,595 S	1/2007	Hasebe		D726,849 S	4/2015	Burns	
7,156,752 B1	1/2007	Bennett		D733,234 S	6/2015	Nicolette	
D536,401 S	2/2007	Kawami		D735,283 S	7/2015	Solheim	
D536,403 S	2/2007	Kawami		D738,447 S *	9/2015	Schweigert	D21/736
D538,371 S	3/2007	Kawami		D738,449 S	9/2015	Schweigert	
7,204,765 B2	4/2007	Cover		D739,487 S	9/2015	Schweigert	
D542,869 S	5/2007	Adams		D741,426 S	10/2015	Schweigert	
D543,596 S	5/2007	Rockwood		D746,926 S	1/2016	Parsons	
D543,601 S	5/2007	Kawami		D748,213 S	1/2016	Parsons et al.	
D555,219 S	11/2007	Lin		D748,215 S	1/2016	Parsons et al.	
D556,277 S	11/2007	Broom		9,233,283 B2	1/2016	Schweigert	
D561,854 S	2/2008	Morris		D752,697 S	3/2016	Claveran	
7,331,876 B2	2/2008	Klein		D753,252 S	4/2016	Schweigert	
7,351,162 B2	4/2008	Soracco		D759,173 S *	6/2016	Rollinson	D21/743
D569,461 S	5/2008	Morris		D762,274 S *	7/2016	Cardani	D21/759
D569,930 S	5/2008	Nehrbas		D763,382 S *	8/2016	Cardani	D21/759
7,396,289 B2	7/2008	Soracco		D765,198 S *	8/2016	Cardani	D21/759
D577,086 S	8/2008	Nicolette et al.		D768,247 S *	10/2016	Rollinson	D21/744
D577,085 S	9/2008	Nicolette et al.		D779,006 S *	2/2017	Abbott	D21/744
D579,506 S	10/2008	Nicolette et al.		D791,891 S	7/2017	Davis	
D579,995 S	11/2008	Nicolette et al.		D794,146 S	8/2017	Davis	
D582,497 S	12/2008	Rollinson		D796,603 S *	9/2017	Serrano	D21/744
7,473,189 B2	1/2009	Schweigert		D802,073 S *	11/2017	Toulon	D21/759
7,491,131 B2	2/2009	Vinton		D812,163 S *	3/2018	Kroloff	D21/736
D590,463 S *	4/2009	Hettinger	D21/743	D826,353 S *	8/2018	Cameron	D21/736
D599,425 S	9/2009	Laub		10,173,105 B2 *	1/2019	Myers	A63B 53/0487
D599,867 S	9/2009	Teramoto		D860,353 S *	9/2019	Rollinson	D21/743
D600,762 S *	9/2009	Serrano	D21/743	10,441,858 B2 *	10/2019	Schweigert	A63B 53/065
D600,763 S	9/2009	Cameron		10,493,331 B2 *	12/2019	Kroloff	A63B 53/0433
D601,214 S	9/2009	Serrano		D872,816 S *	1/2020	Parsons	D21/736
D603,007 S *	10/2009	Franklin	D21/736	D873,358 S *	1/2020	Lee	D21/744
D607,951 S	1/2010	Teramoto		D879,223 S *	3/2020	Serrano	D21/742
7,744,485 B2	6/2010	Jones		D879,895 S *	3/2020	Schweigert	D21/759
D620,993 S	8/2010	Laub		10,646,758 B2 *	5/2020	Schweigert	A63B 60/02
D623,709 S	9/2010	Serrano et al.		D892,955 S *	8/2020	Clarke	D21/744
D631,925 S	2/2011	Broom		D895,747 S *	9/2020	Rollinson	D21/743
7,887,432 B2	2/2011	Jones		D896,903 S *	9/2020	Schweigert	D21/743
D633,964 S	3/2011	Teramoto		D898,846 S *	10/2020	Clarke	D21/743
D634,801 S *	3/2011	Rollinson	D21/743	D898,847 S *	10/2020	Clarke	D21/743
7,909,707 B2	3/2011	Klein		2007/0142122 A1	6/2007	Bonneau	
D635,625 S *	4/2011	Rollinson	D21/743	2007/0207875 A1	9/2007	Kuan	
7,918,745 B2	4/2011	Morris		2007/0238548 A1	10/2007	Johnson	
7,927,226 B1	4/2011	Twitty		2008/0139333 A1	6/2008	Klein	
D638,891 S *	5/2011	Nicolette	D21/736	2008/0146372 A1	6/2008	John	
D642,643 S	8/2011	Nicolette et al.		2008/0176672 A1	7/2008	Roach	
D643,485 S	8/2011	Nicolette et al.		2011/0165959 A1	7/2011	Klein	
D644,703 S *	9/2011	Serrano	D21/743	2013/0165256 A1	6/2013	Stevenson	
D645,104 S	9/2011	Nicolette et al.		2013/0210537 A1	8/2013	Ainscough	
D648,408 S *	11/2011	Teramoto	D21/743				
8,096,039 B2	1/2012	Soracco					
D653,718 S	2/2012	Stokke et al.					
D655,361 S	3/2012	Ramsauer					
D661,753 S	6/2012	Cameron et al.					
D661,754 S *	6/2012	Cameron	D21/759				
D666,260 S	8/2012	Cynn					
8,371,958 B2 *	2/2013	Treadwell	A63B 53/04 473/331				
8,376,878 B2	2/2013	Bennett					
D688,339 S	8/2013	Hilton et al.					
D688,341 S	8/2013	Rollinson					
D691,226 S	10/2013	Hilton et al.					
D691,681 S *	10/2013	Hilton	D21/736				
D699,308 S	2/2014	Rollinson					
D704,782 S	5/2014	Rollinson					
8,721,472 B2	5/2014	Kuan					
8,790,193 B2	7/2014	Serrano					
D711,483 S	8/2014	Wong					
D720,022 S *	12/2014	Rollinson	D21/736				
D720,023 S *	12/2014	Rollinson	D21/736				
D720,411 S *	12/2014	Rollinson	D21/743				

FOREIGN PATENT DOCUMENTS

JP 20050160691 6/2005

OTHER PUBLICATIONS

U.S. Appl. No. 14/586,720, Parsons et al., "Golf Club Heads and Methods to Manufacture Golf Club Heads," filed Dec. 30, 2014.
 U.S. Appl. No. 29/523,587, Schweigert, "Golf Club Head," filed Apr. 10, 2015.
 TourSpecGolf (Gold's Factory Multi Weighted Custom Putter) [online]. Nov. 20, 2010 [retrieved Jul. 7, 2015]. Retrieved from the internet: <URL: <http://www.toursecgolf.com/blog/golds-factory-multi-weighted-custom-putter/>>.
 International Search Report and Written Opinion Issued in Connection With Corresponding Application No. PCT/US15/27841 dated Jul. 30, 2015 (14 pages).

* cited by examiner

Primary Examiner — Mitchell I. Siegel

(57)

CLAIM

The ornamental design for a golf club head, as shown and described.

DESCRIPTION

FIG. 1 is a top perspective view of a golf club head;
FIG. 2 is a bottom perspective view of the golf club head of FIG. 1;
FIG. 3 is a front elevational view of the golf club head of FIG. 1;
FIG. 4 is a rear elevational view of the golf club head of FIG. 1;
FIG. 5 is a top view of the golf club head of FIG. 1;
FIG. 6 is a bottom view of the golf club head of FIG. 1;
FIG. 7 is a left side view of the golf club head of FIG. 1;
FIG. 8 is a right side view of the golf club head of FIG. 1;
FIG. 9 is a top perspective view of a golf club head;
FIG. 10 is a bottom perspective view of the golf club head of FIG. 9;
FIG. 11 is a front elevational view of the golf club head of FIG. 9;

FIG. 12 is a rear elevational view of the golf club head of FIG. 9;

FIG. 13 is a top view of the golf club head of FIG. 9;

FIG. 14 is a bottom view of the golf club head of FIG. 9;

FIG. 15 is a left side view of the golf club head of FIG. 9;

FIG. 16 is a right side view of the golf club head of FIG. 9;

FIG. 17 is a top perspective view of a golf club head;

FIG. 18 is a bottom perspective view of the golf club head of FIG. 17;

FIG. 19 is a front elevational view of the golf club head of FIG. 17;

FIG. 20 is a rear elevational view of the golf club head of FIG. 17;

FIG. 21 is a top view of the golf club head of FIG. 17;

FIG. 22 is a bottom view of the golf club head of FIG. 17;

FIG. 23 is a left side view of the golf club head of FIG. 17;

and,

FIG. 24 is a right side view of the golf club head of FIG. 17.

The broken line showing is included for the purpose of illustrating unclaimed subject matter and forms no part of the claimed design.

1 Claim, 21 Drawing Sheets

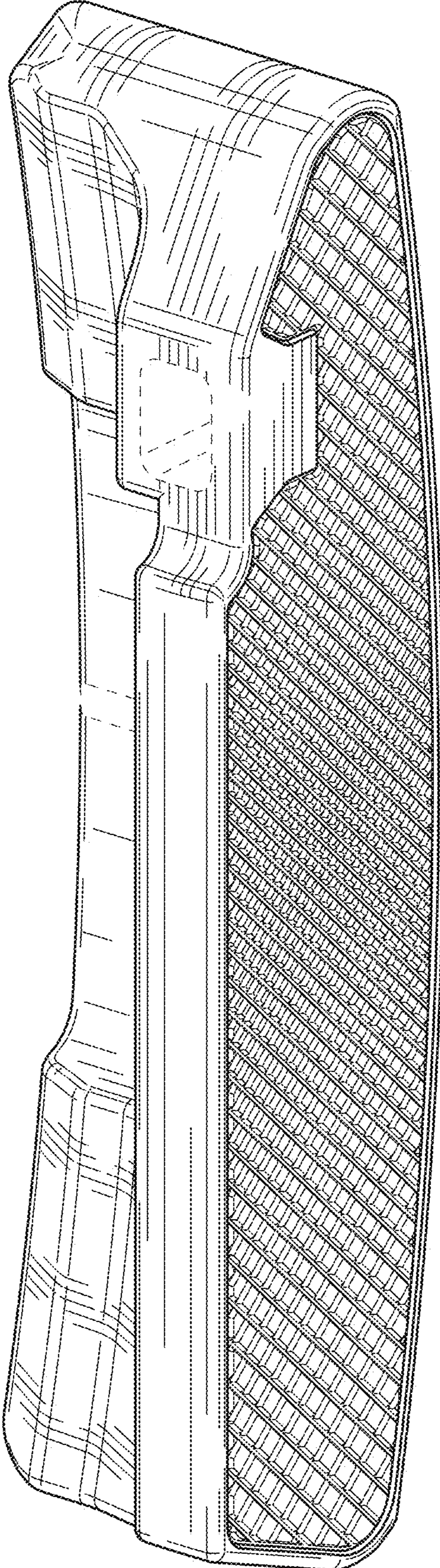

FIG. 1

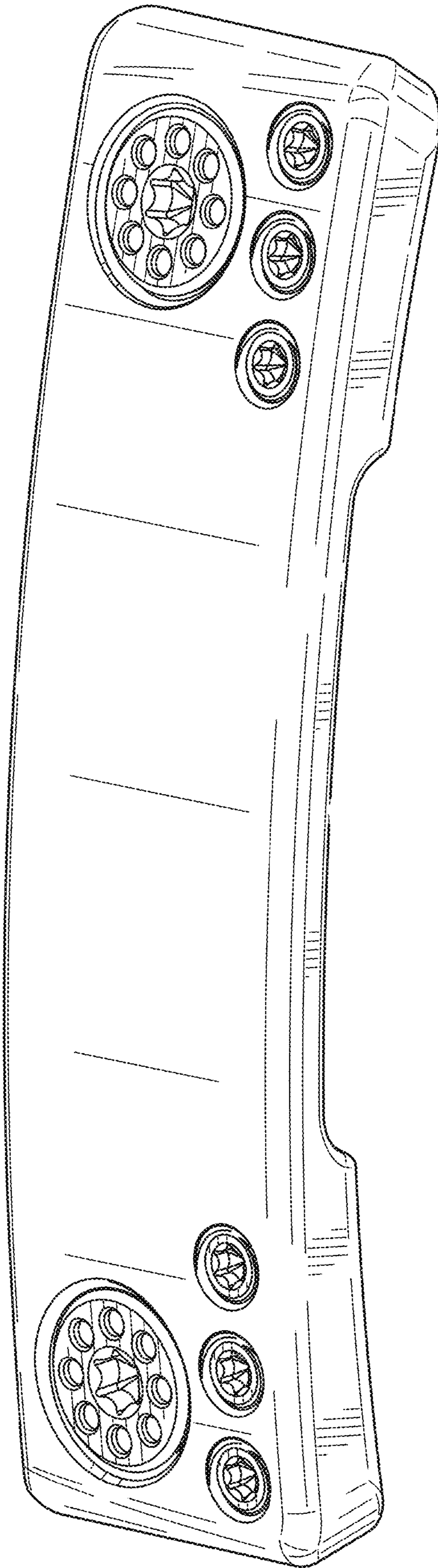

FIG. 2

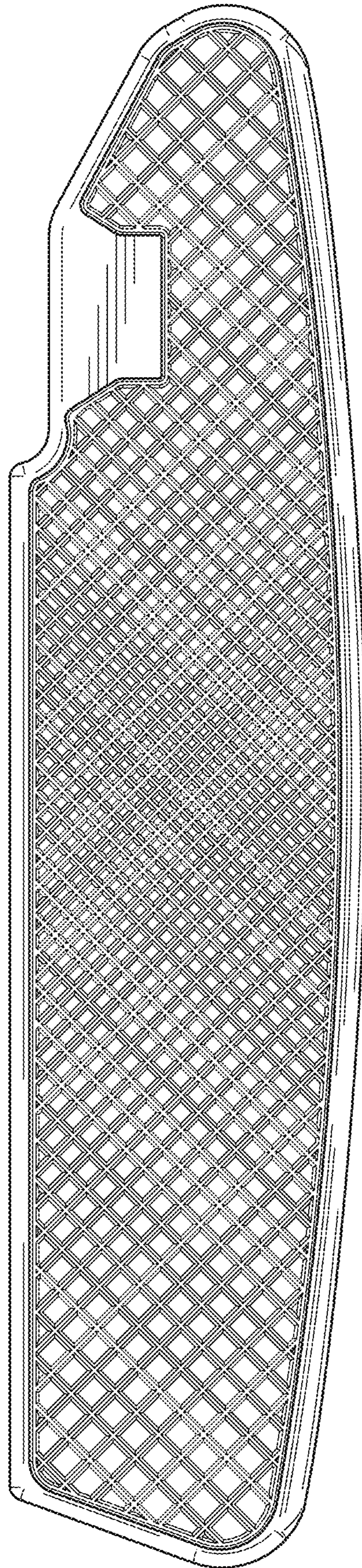

FIG. 3

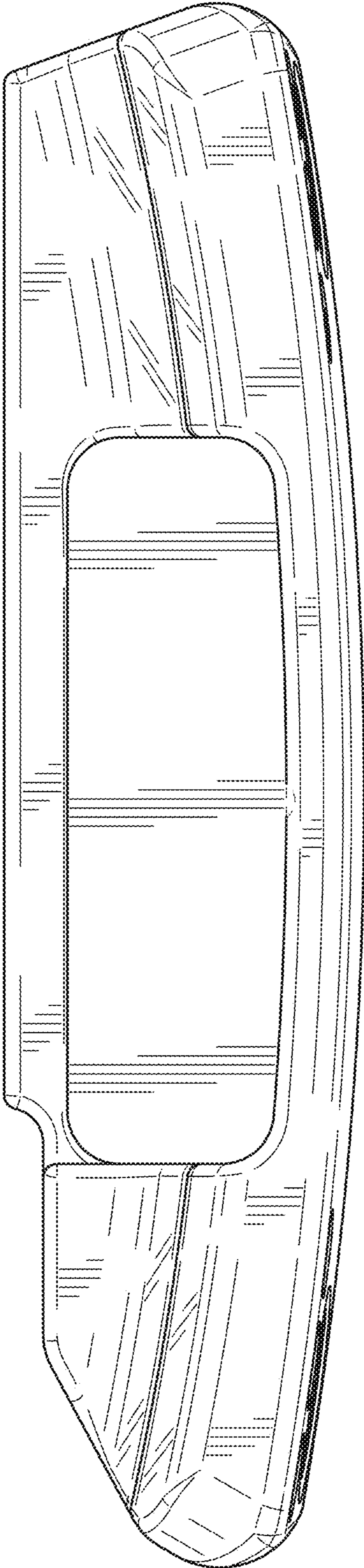

FIG. 4

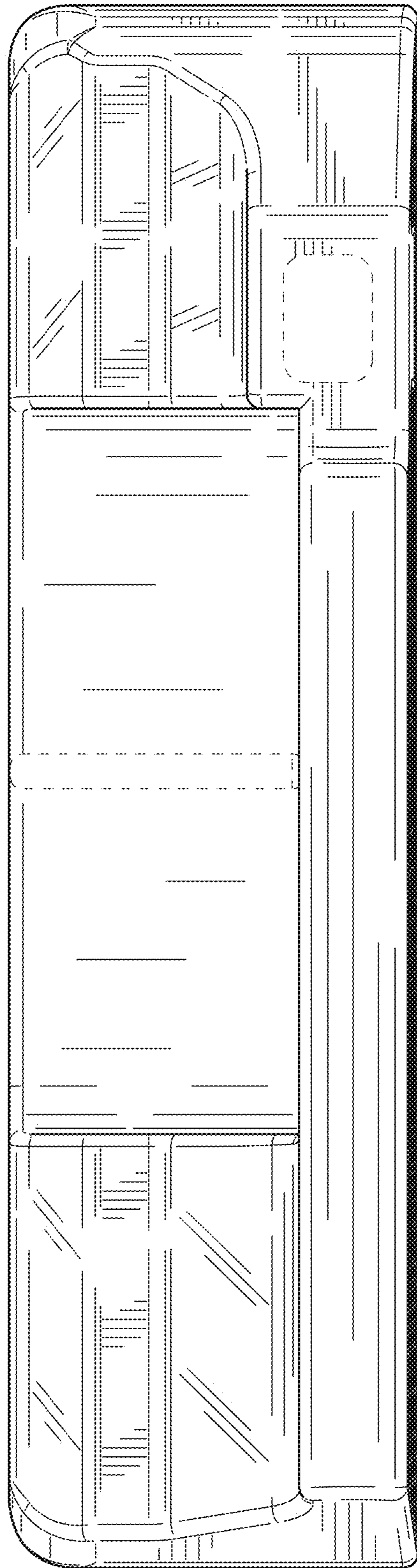

FIG. 5

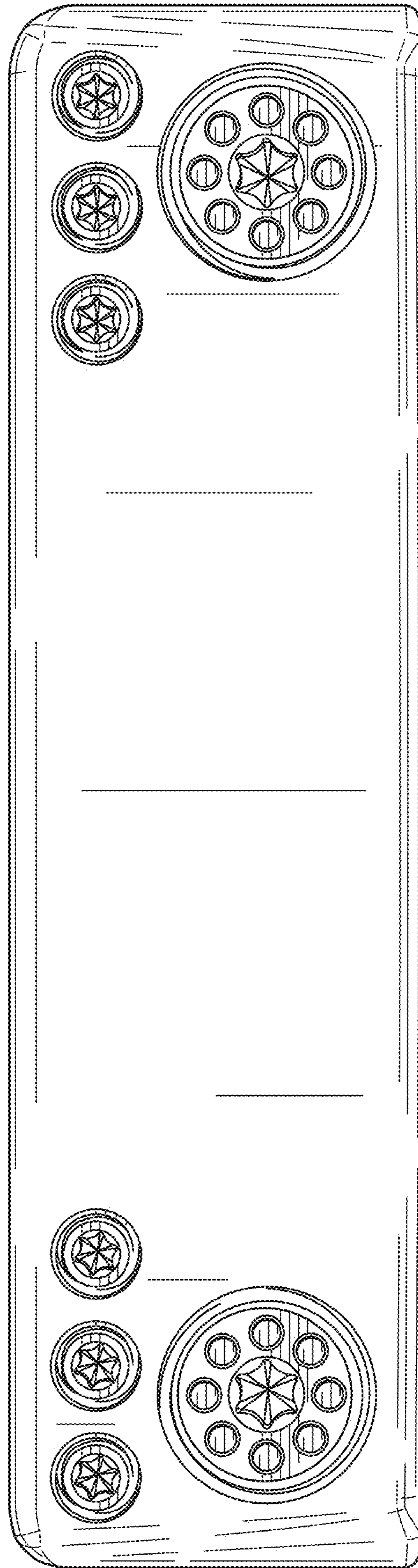

FIG. 6

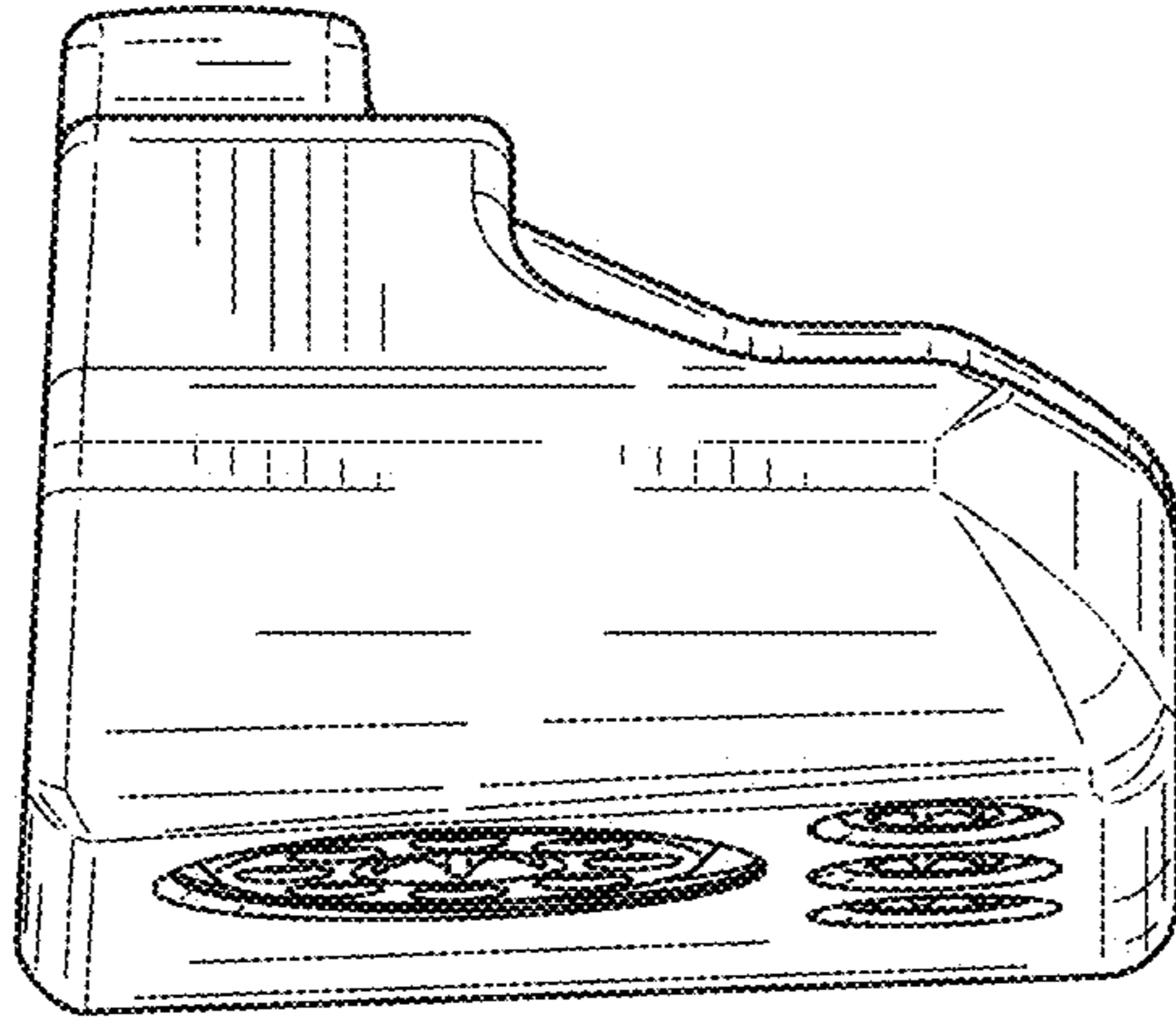

FIG. 7

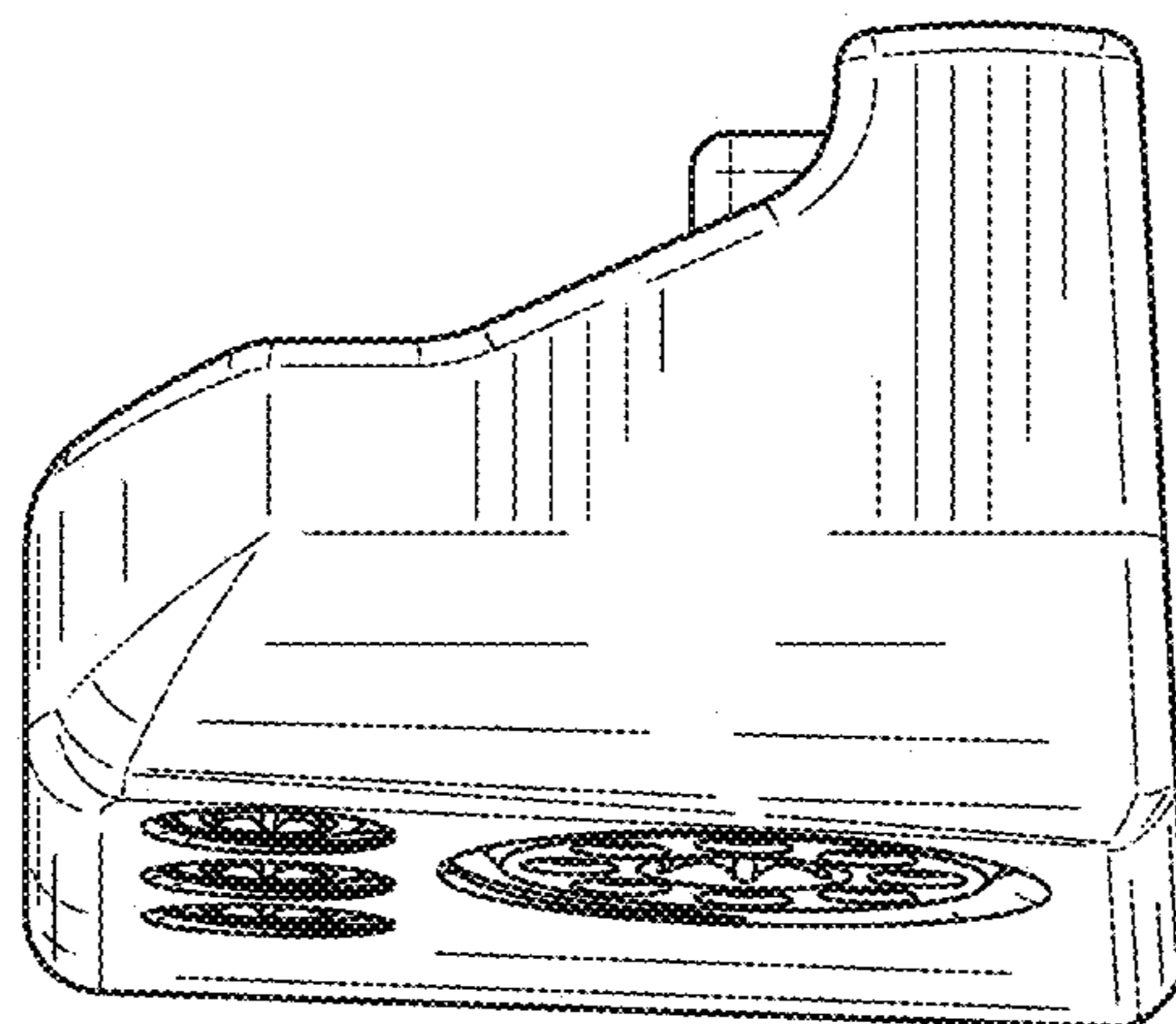

FIG. 8

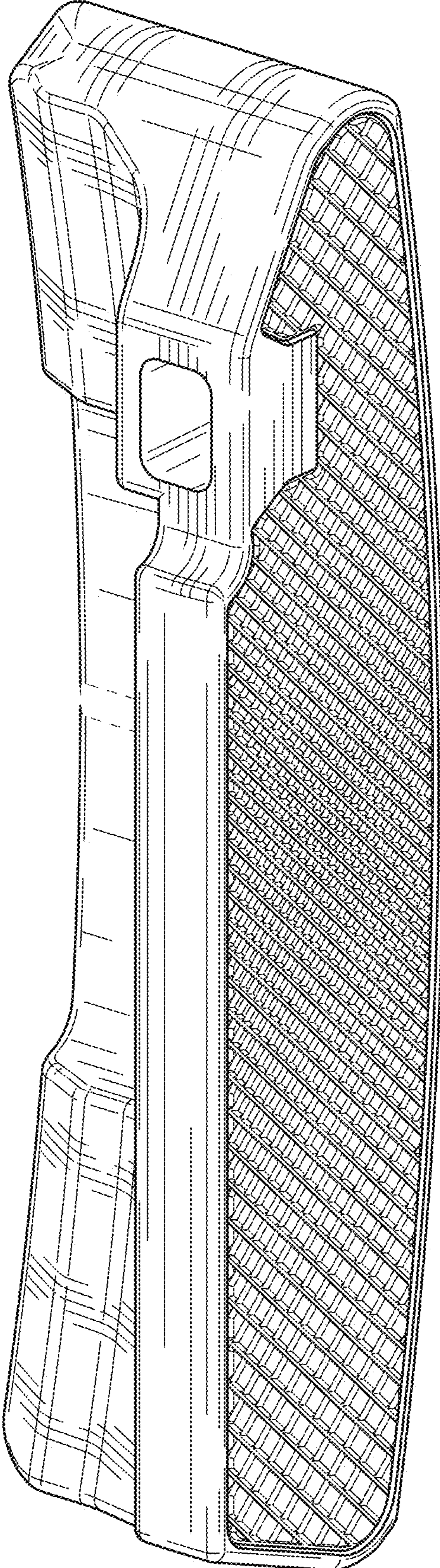

FIG. 9

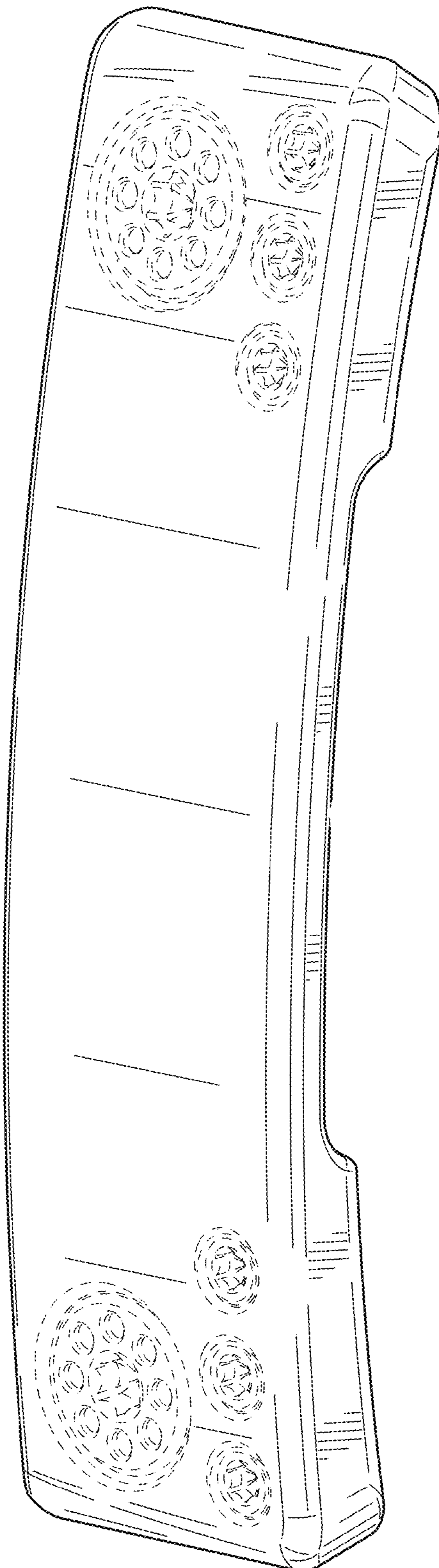

FIG. 10

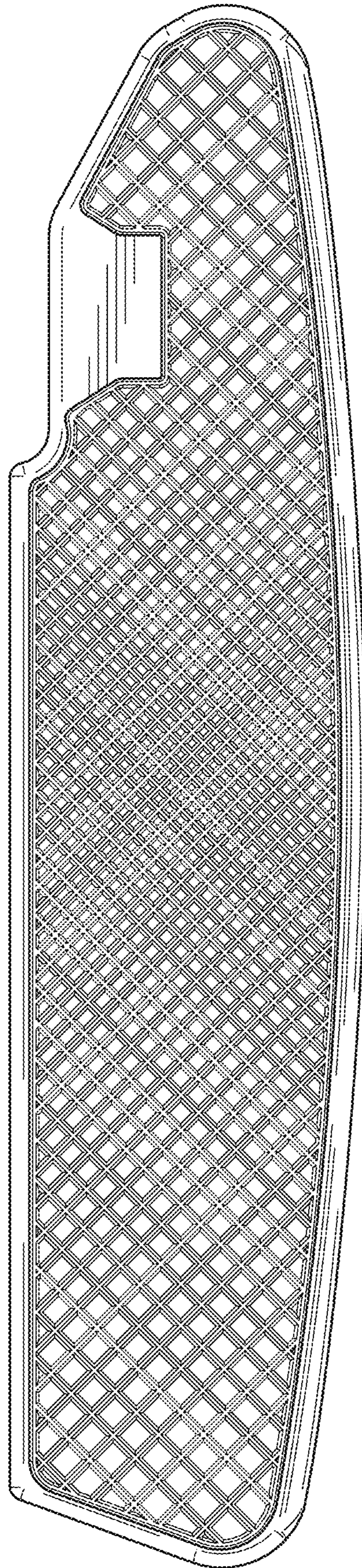

FIG. 11

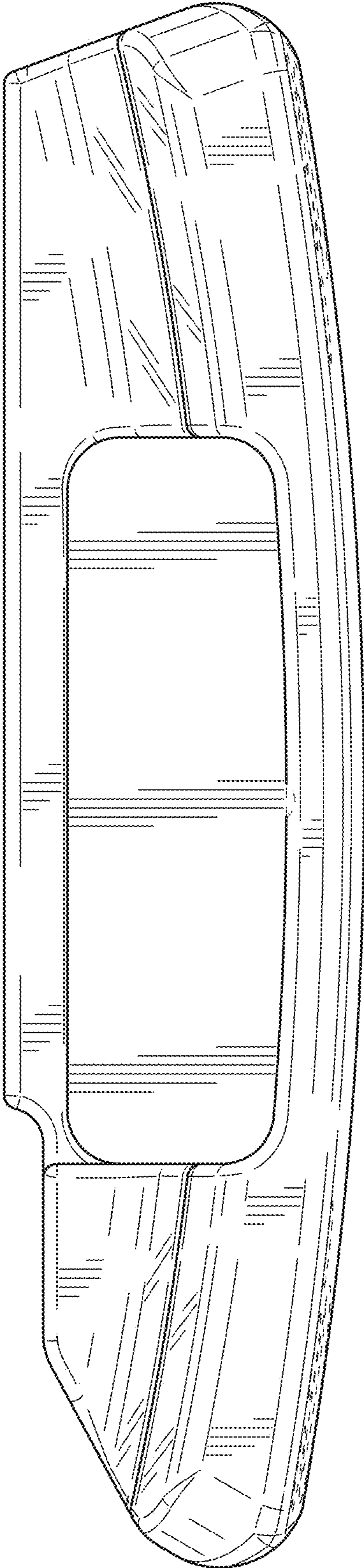

FIG. 12

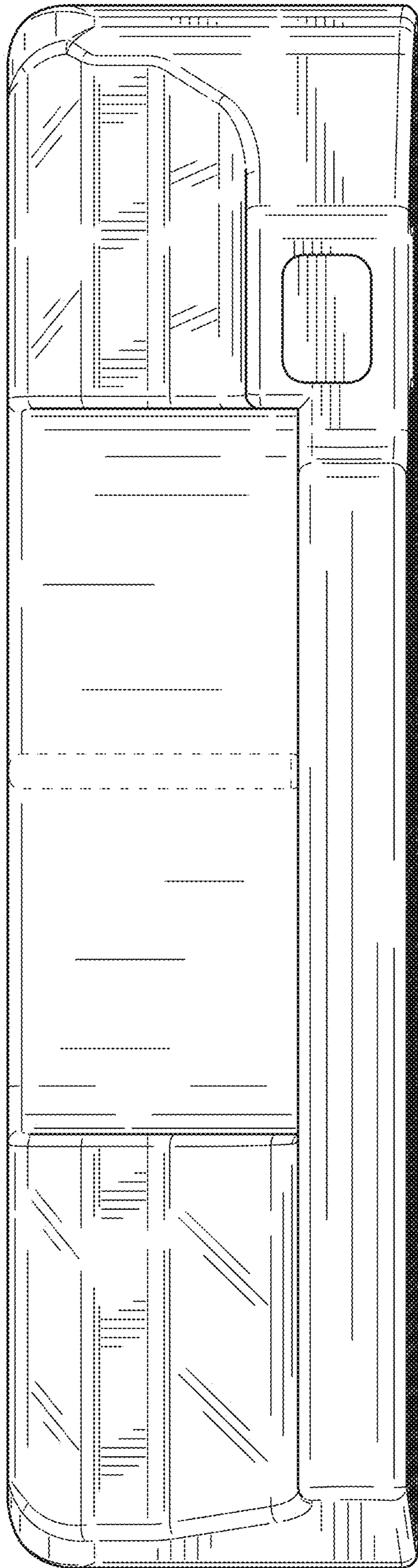

FIG. 13

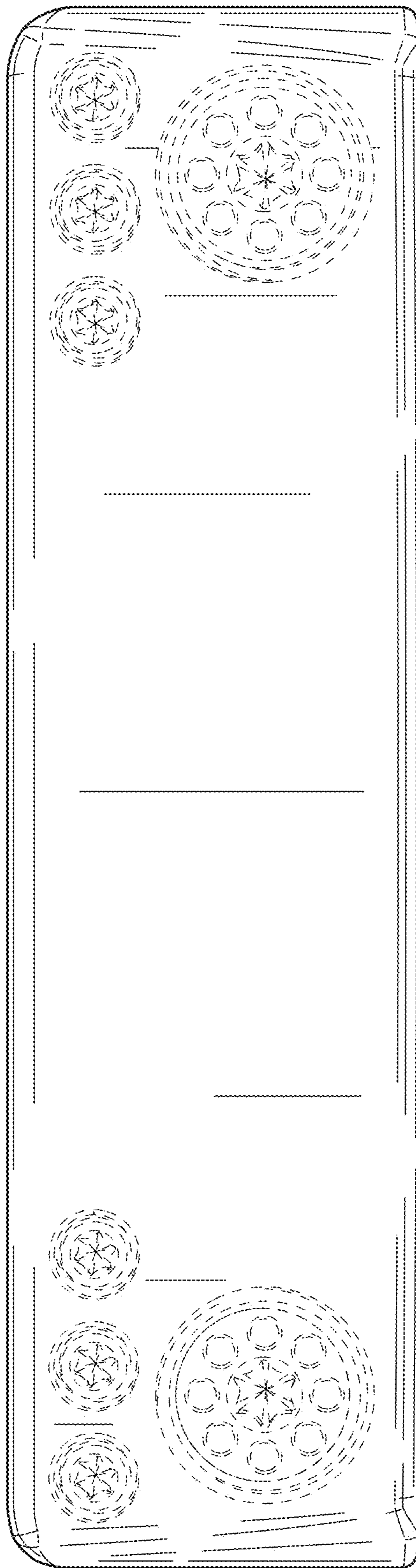

FIG. 14

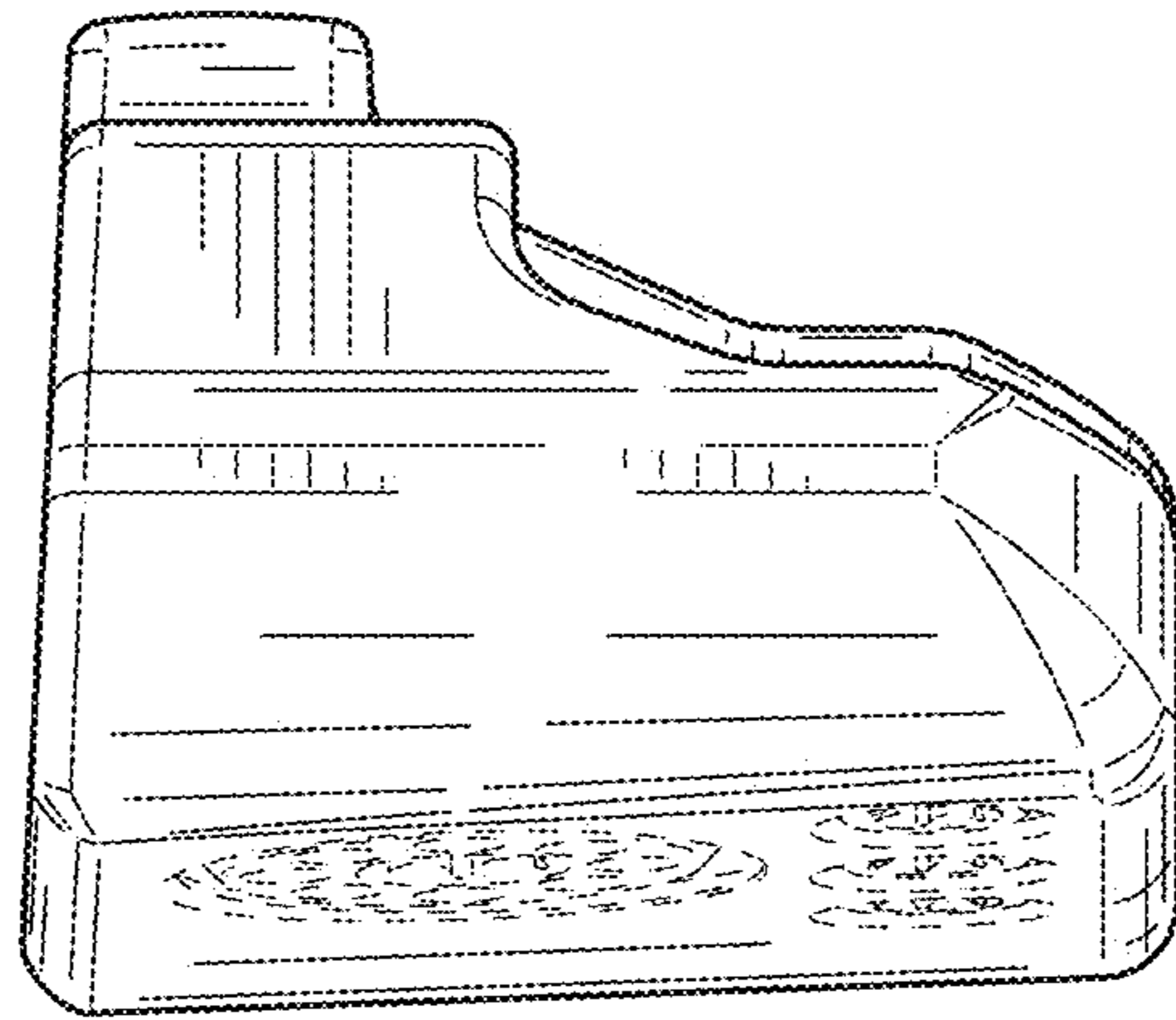

FIG. 15

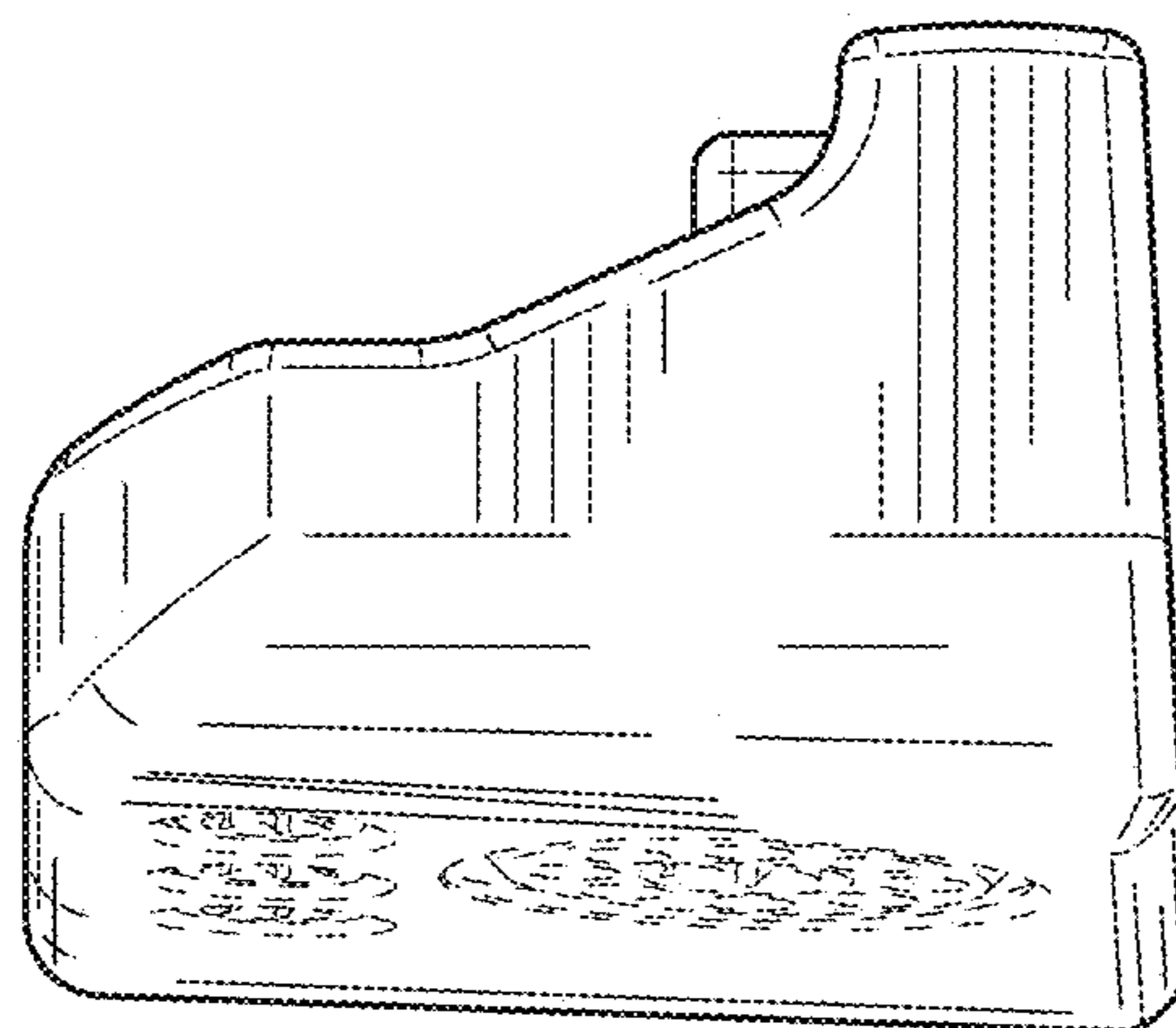

FIG. 16

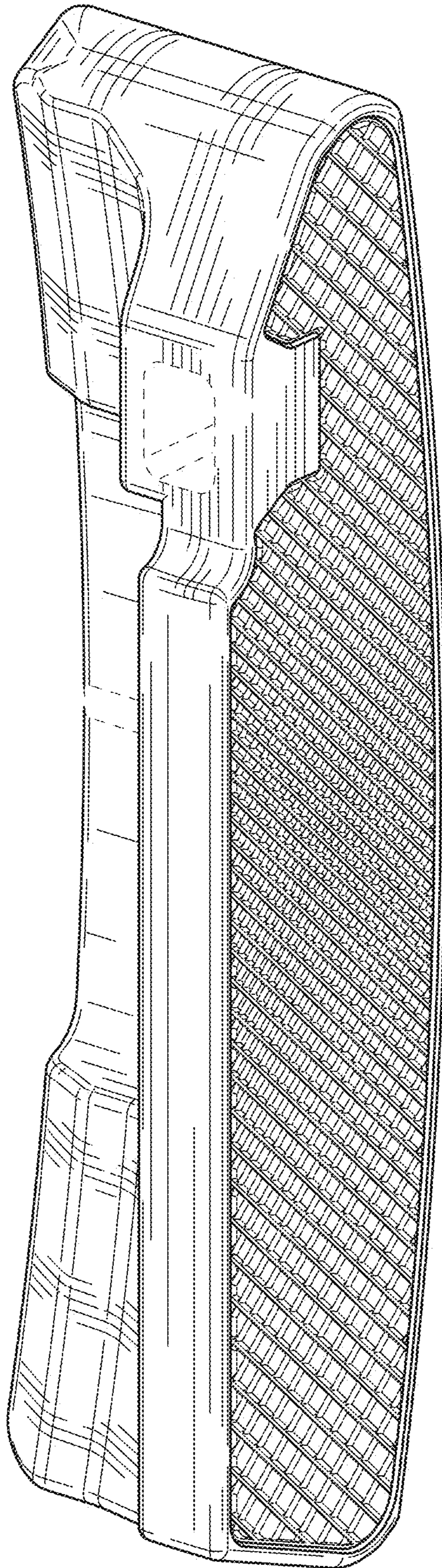

FIG. 17

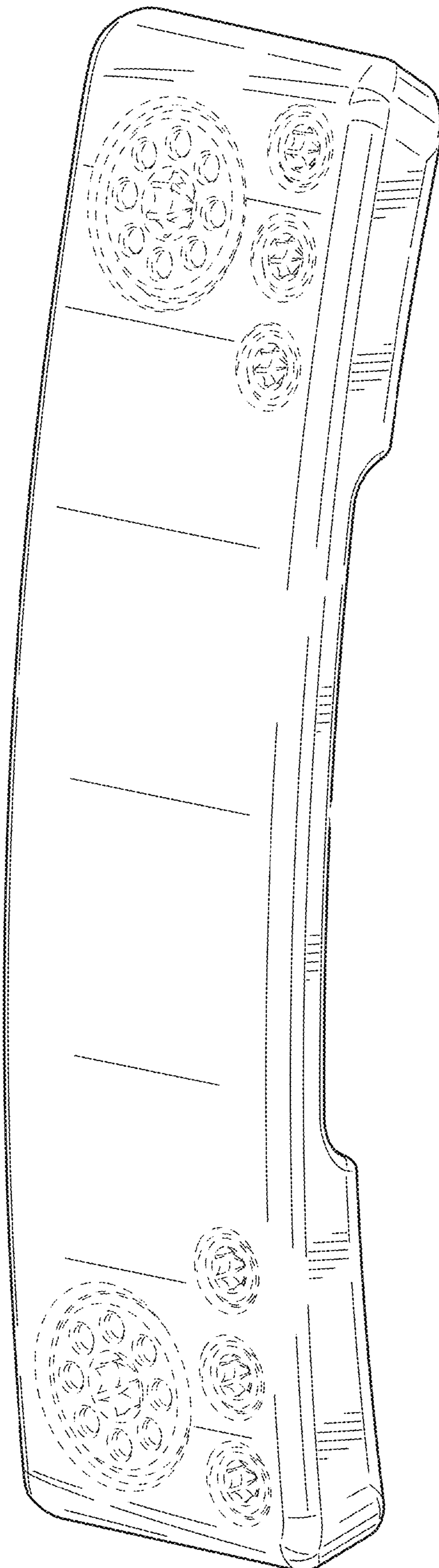

FIG. 18

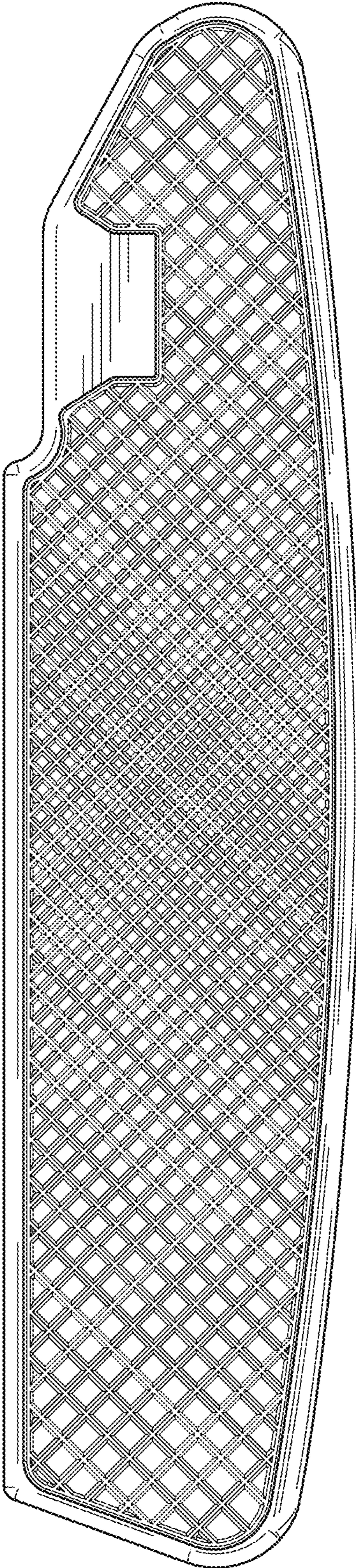

FIG. 19

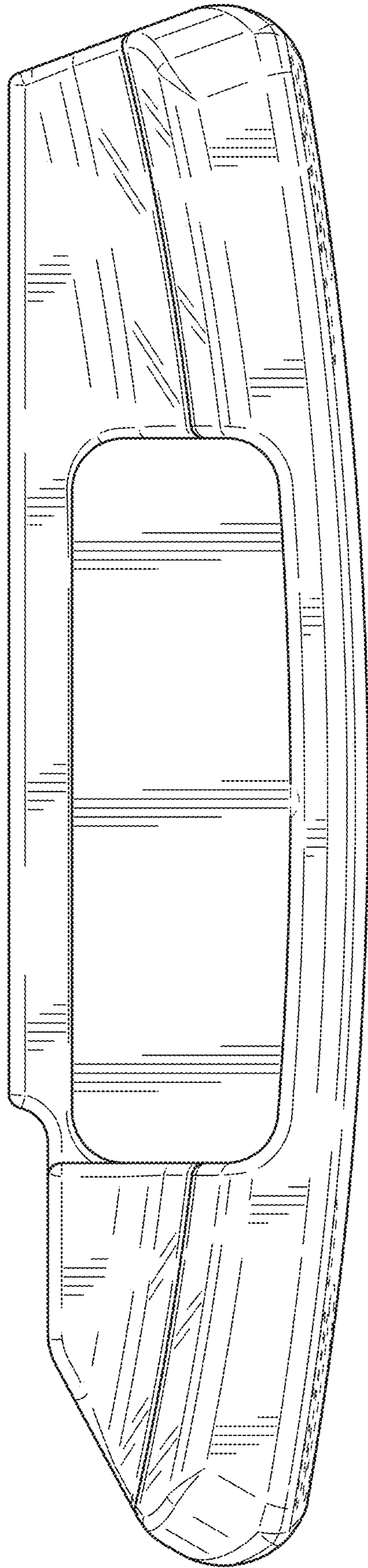

FIG. 20

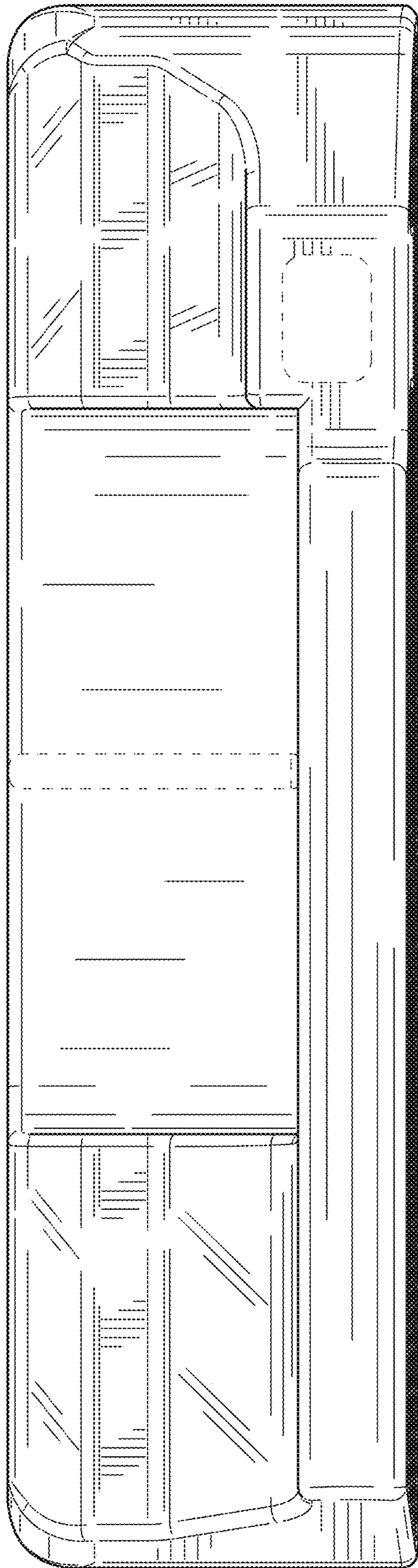

FIG. 21

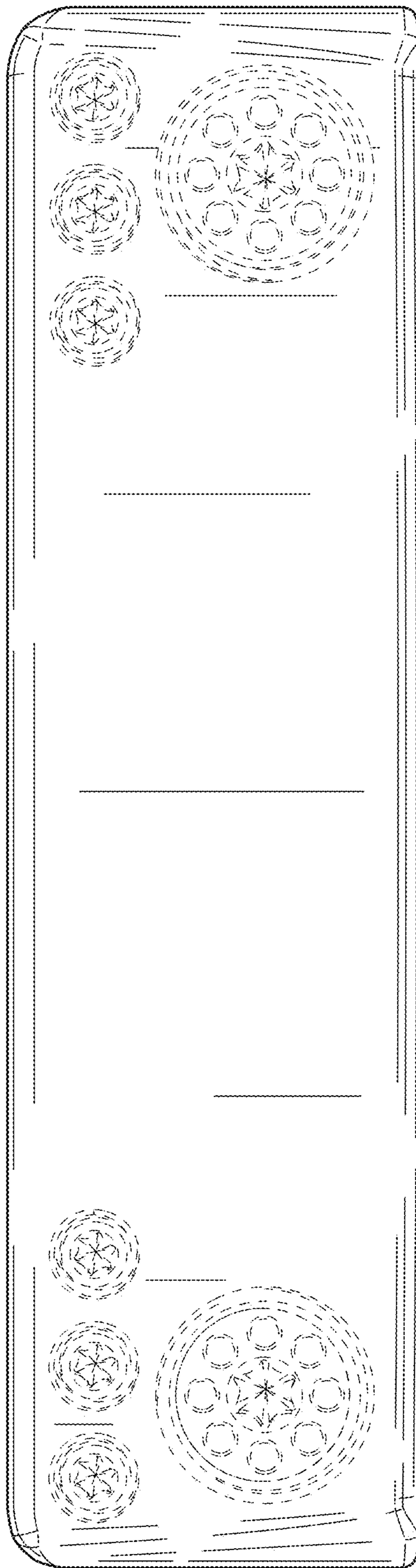

FIG. 22

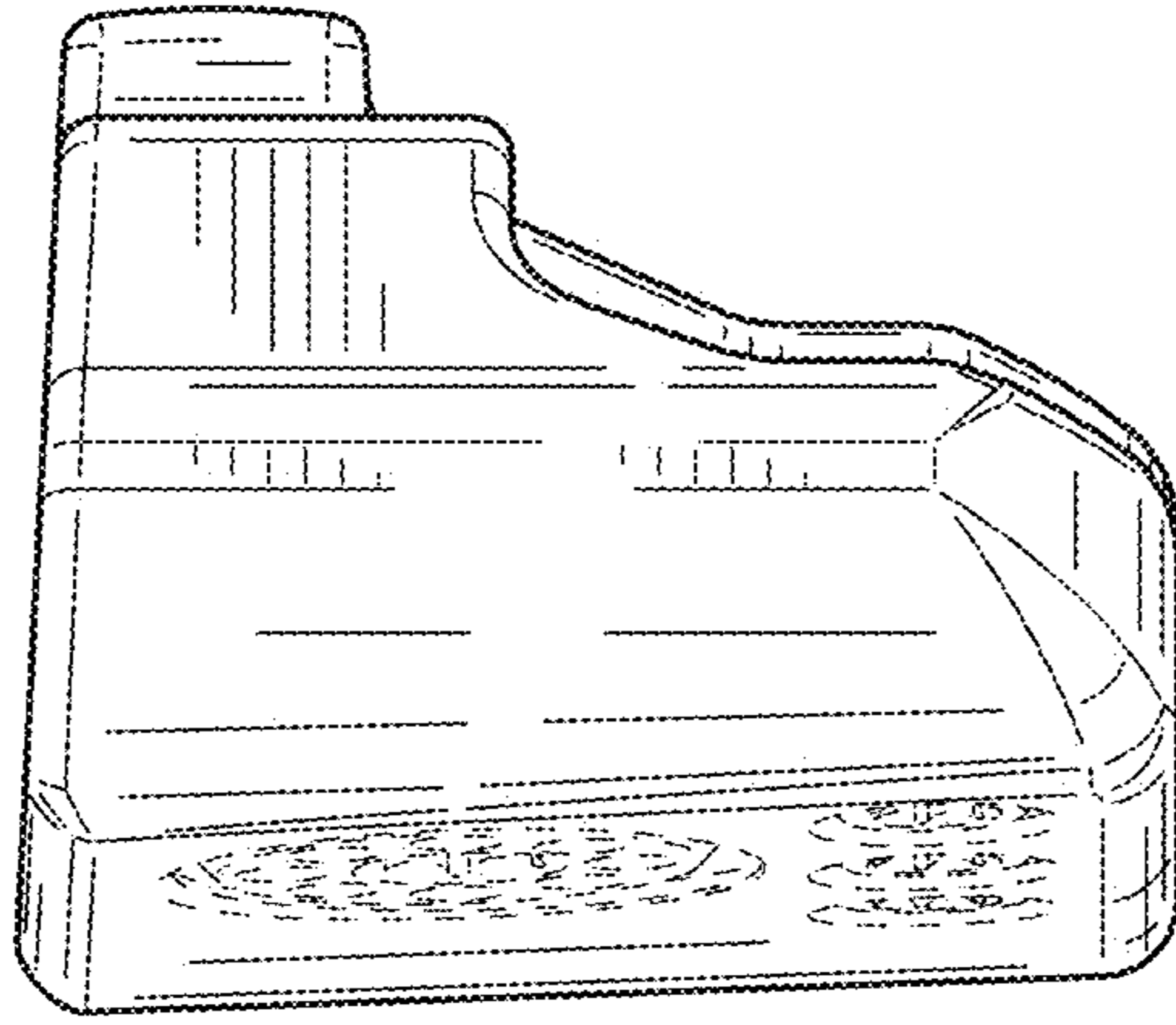

FIG. 23

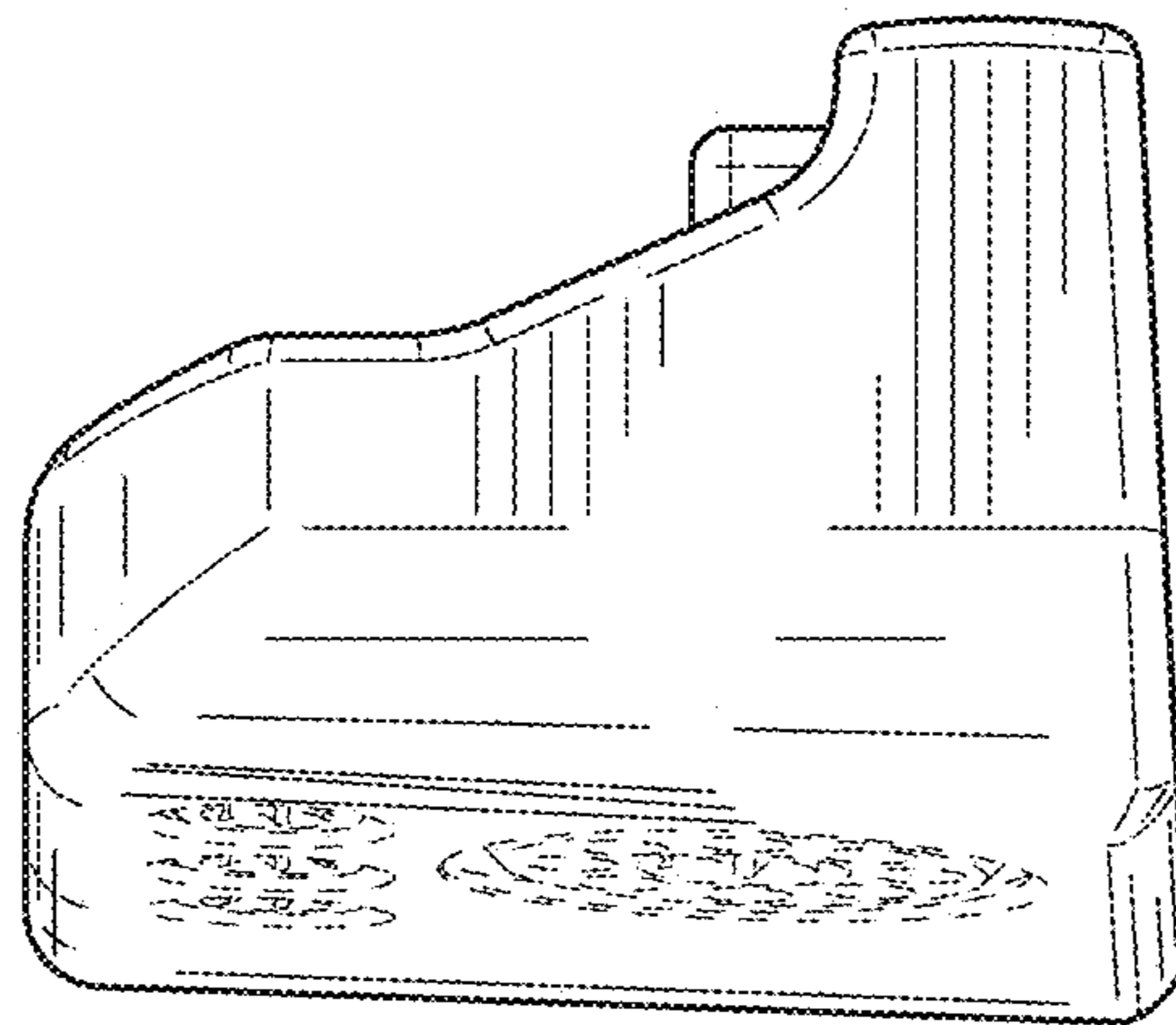

FIG. 24