



US00D926593S

(12) **United States Design Patent** (10) **Patent No.:** **US D926,593 S**  
**Frandsen et al.** (45) **Date of Patent:** **\*\* Aug. 3, 2021**

(54) **BOX FOR PAPER TISSUES**  
(71) Applicant: **LastSwab ApS**, Copenhagen (DK)  
(72) Inventors: **Kåre Frandsen**, Copenhagen (DK);  
**Nicolas Aagaard**, Holte (DK)  
(\*\*) Term: **15 Years**  
(21) Appl. No.: **35/509,203**  
(22) Filed: **Mar. 18, 2020**

RE43,304 E \* 4/2012 Zanaletti ..... D9/422  
D668,141 S \* 10/2012 Collins ..... D9/423  
D668,534 S \* 10/2012 Collins ..... D9/423  
D741,002 S \* 10/2015 Liu ..... D27/189  
D787,324 S \* 5/2017 Sotka ..... D9/433  
D811,873 S \* 3/2018 Turner ..... D9/432  
D858,274 S \* 9/2019 Perella ..... D9/432  
D861,484 S \* 10/2019 Patel ..... D9/432  
D862,873 S \* 10/2019 Ye ..... D3/201  
D863,958 S \* 10/2019 Tidwell ..... D9/435  
D868,457 S \* 12/2019 Hagerman ..... D3/226  
D891,775 S \* 8/2020 Eremita ..... D3/303  
D899,247 S \* 10/2020 Kilduff ..... D9/432  
D905,550 S \* 12/2020 Noda ..... D9/432  
D907,295 S \* 1/2021 Baek ..... D28/76

(80) **Hague Agreement Data**

Int. Filing Date: **Mar. 18, 2020**  
Int. Reg. No.: **DM/207315**  
Int. Reg. Date: **Mar. 18, 2020**  
Int. Reg. Pub. Date: **Apr. 24, 2020**

(51) **LOC (13) Cl.** ..... **09-01**  
(52) **U.S. Cl.**  
USPC ..... **D9/734; D9/432**  
(58) **Field of Classification Search**  
USPC ..... D3/201, 203.1–203.3, 203.5–203.8,  
D3/202–207, 212, 218, 219, 221, 222,  
D3/225–228, 230, 232, 246, 254,  
D3/263–268, 272, 273, 281–283, 290,  
D3/291, 294; D9/414, 431–433, 499,  
D9/703, 707, 420, 734  
CPC ..... B65D 43/20  
See application file for complete search history.

(56) **References Cited**

**U.S. PATENT DOCUMENTS**

2,361,597 A \* 10/1944 Buttery ..... B65D 5/543  
229/225  
D250,748 S \* 1/1979 Leger ..... D9/420  
D365,206 S \* 12/1995 Goodman ..... D3/273  
D477,896 S \* 7/2003 Weiss ..... D28/85  
D575,636 S \* 8/2008 Krautter ..... D9/420

**OTHER PUBLICATIONS**

The Gadgeteer. LastTissue is the handkerchief for the 21st century.  
Jan. 29, 2020. <https://the-gadgeteer.com/2020/01/29/lasttissue-is-the-handkerchief-for-the-21st-century/> (Year: 2020).\*

\* cited by examiner

*Primary Examiner* — Darcey E Gottschalk

(57) **CLAIM**

The ornamental design for a box for paper tissues, as shown and described.

**DESCRIPTION**

- 1. Box for paper tissues
- 1.1 : Perspective
- 1.2 : Perspective
- 1.3 : Front
- 1.4 : Back
- 1.5 : Bottom
- 1.6 : Top
- 1.7 : Left
- 1.8 : Right
- 1.9 : Left

**1 Claim, 9 Drawing Sheets**

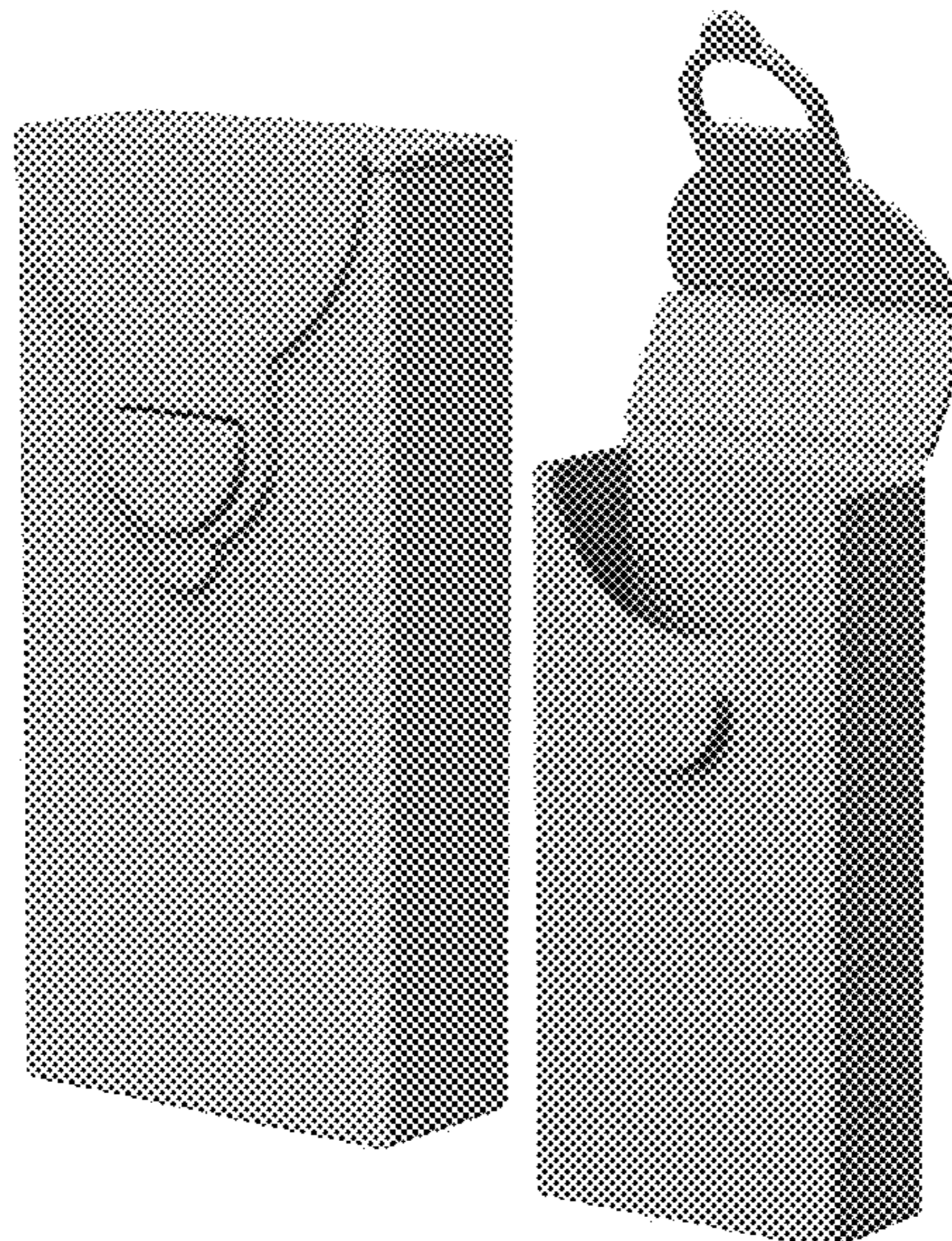

1.1

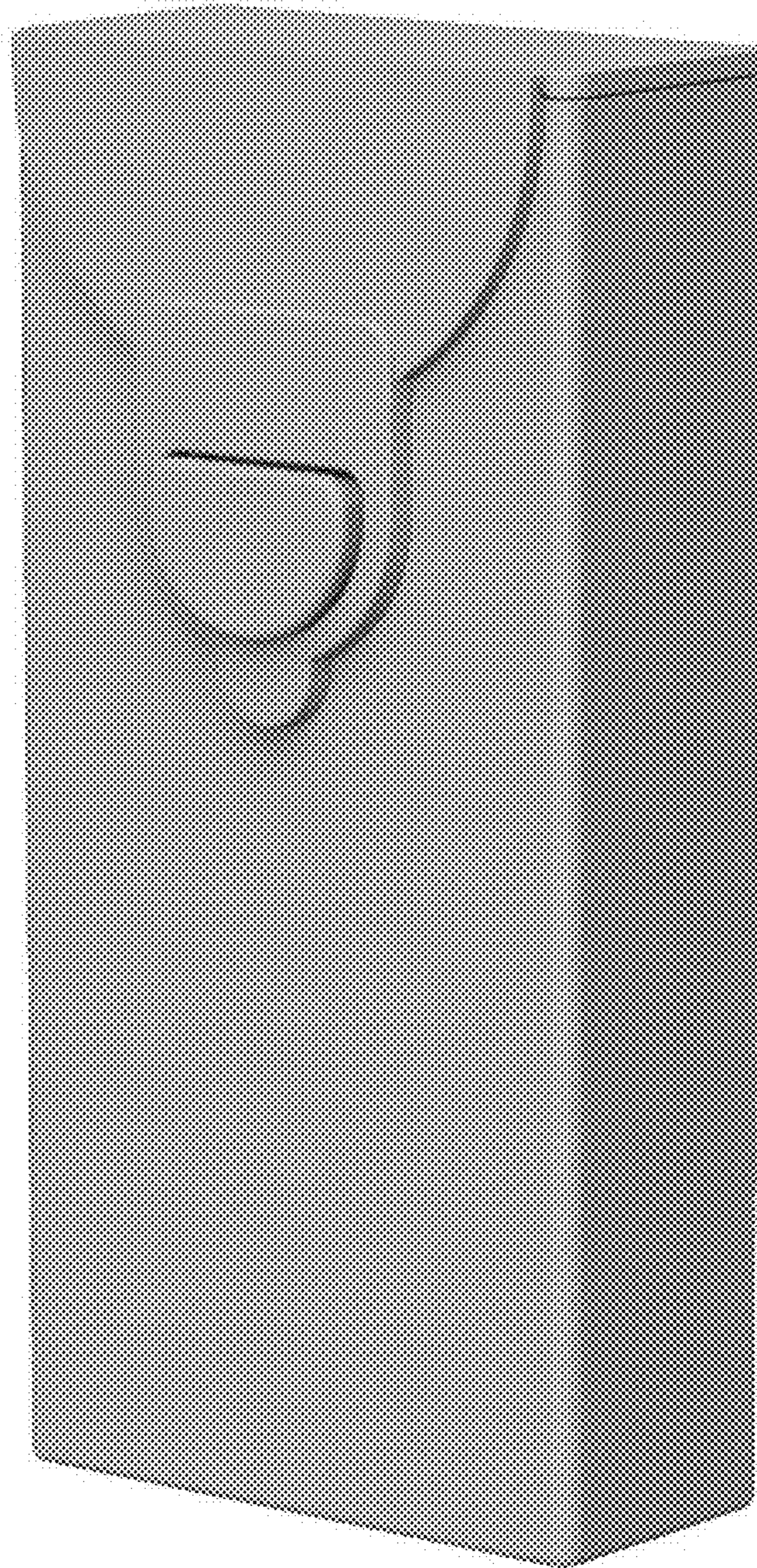

1.2

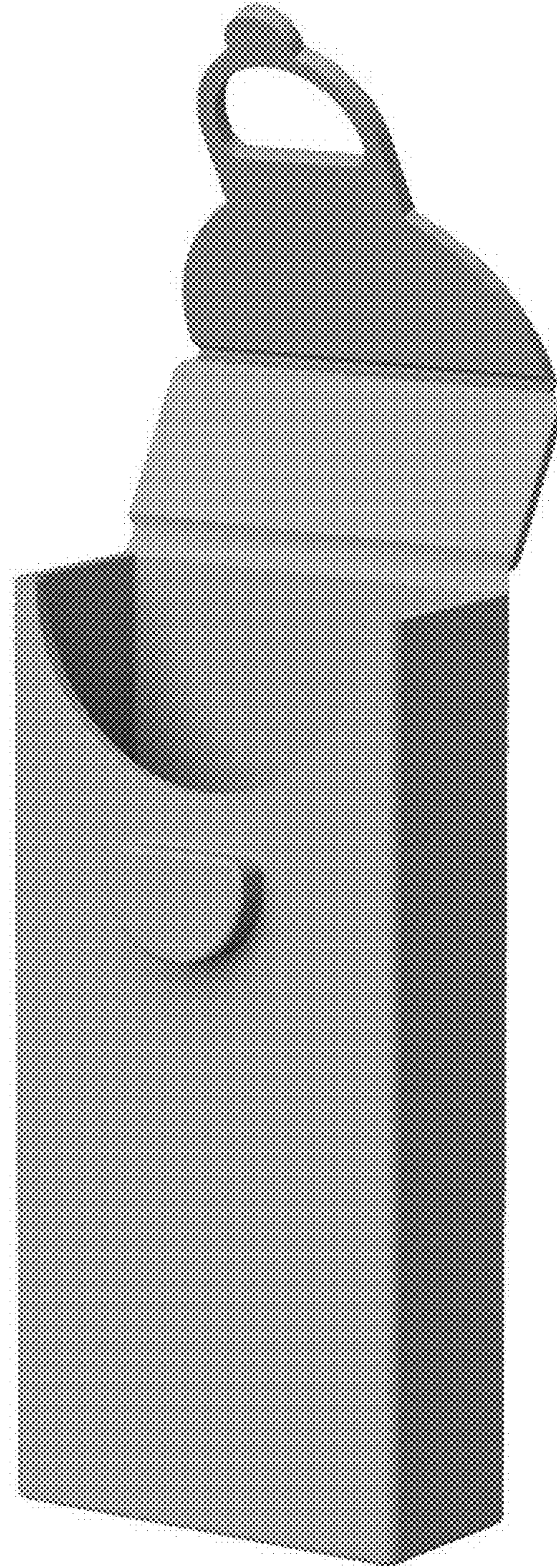

1.3

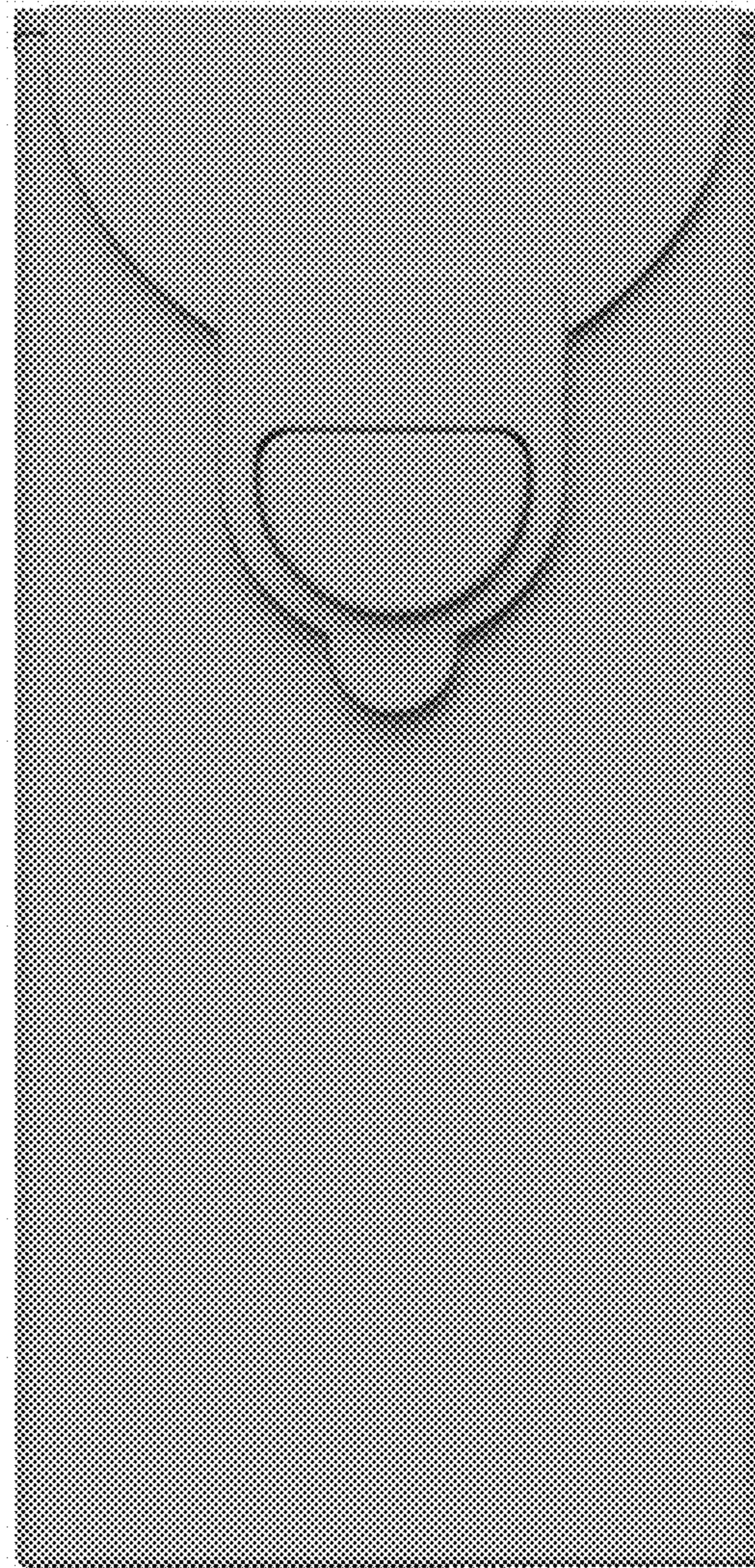

1.4

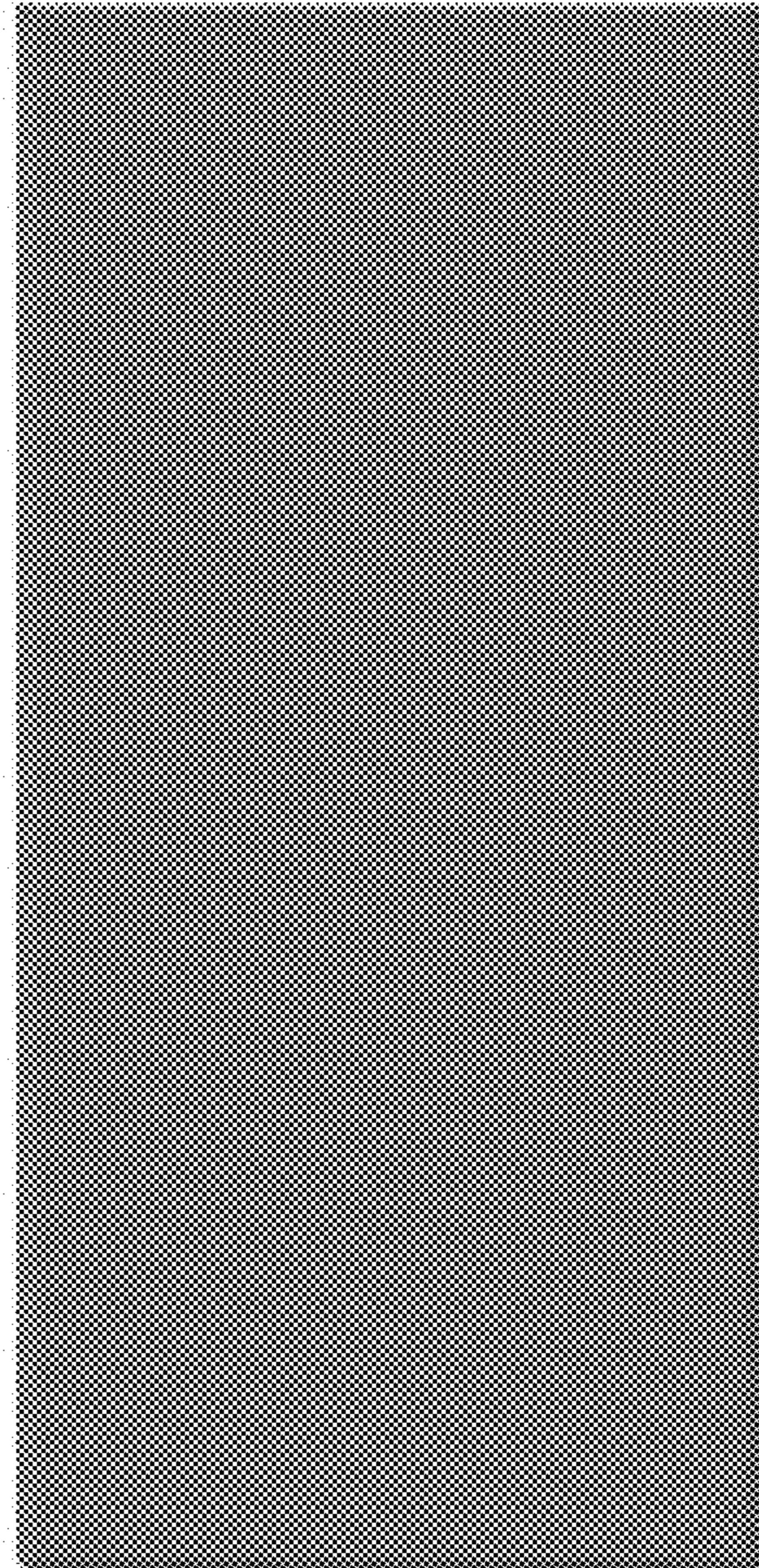

1.5

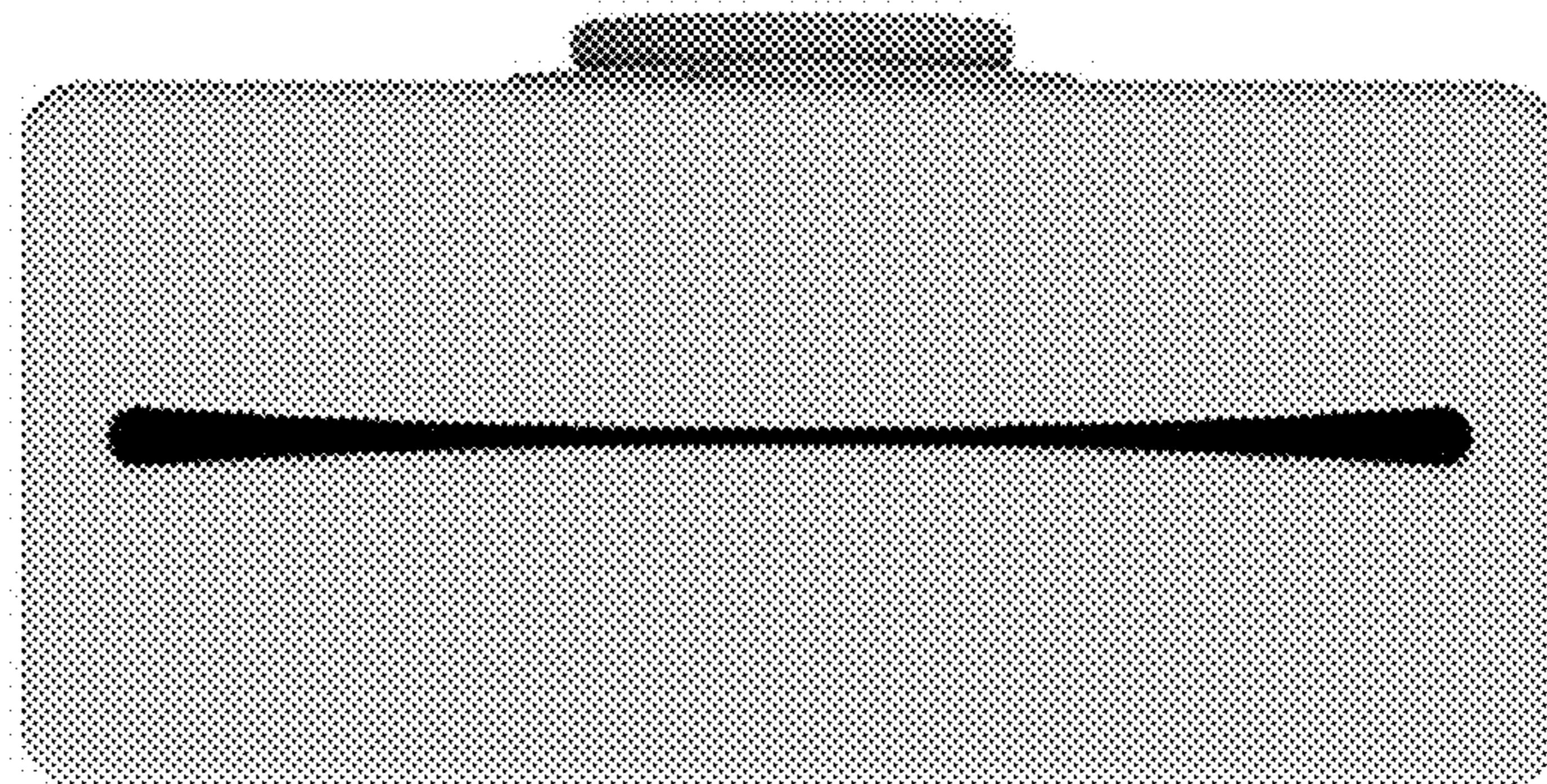

1.6

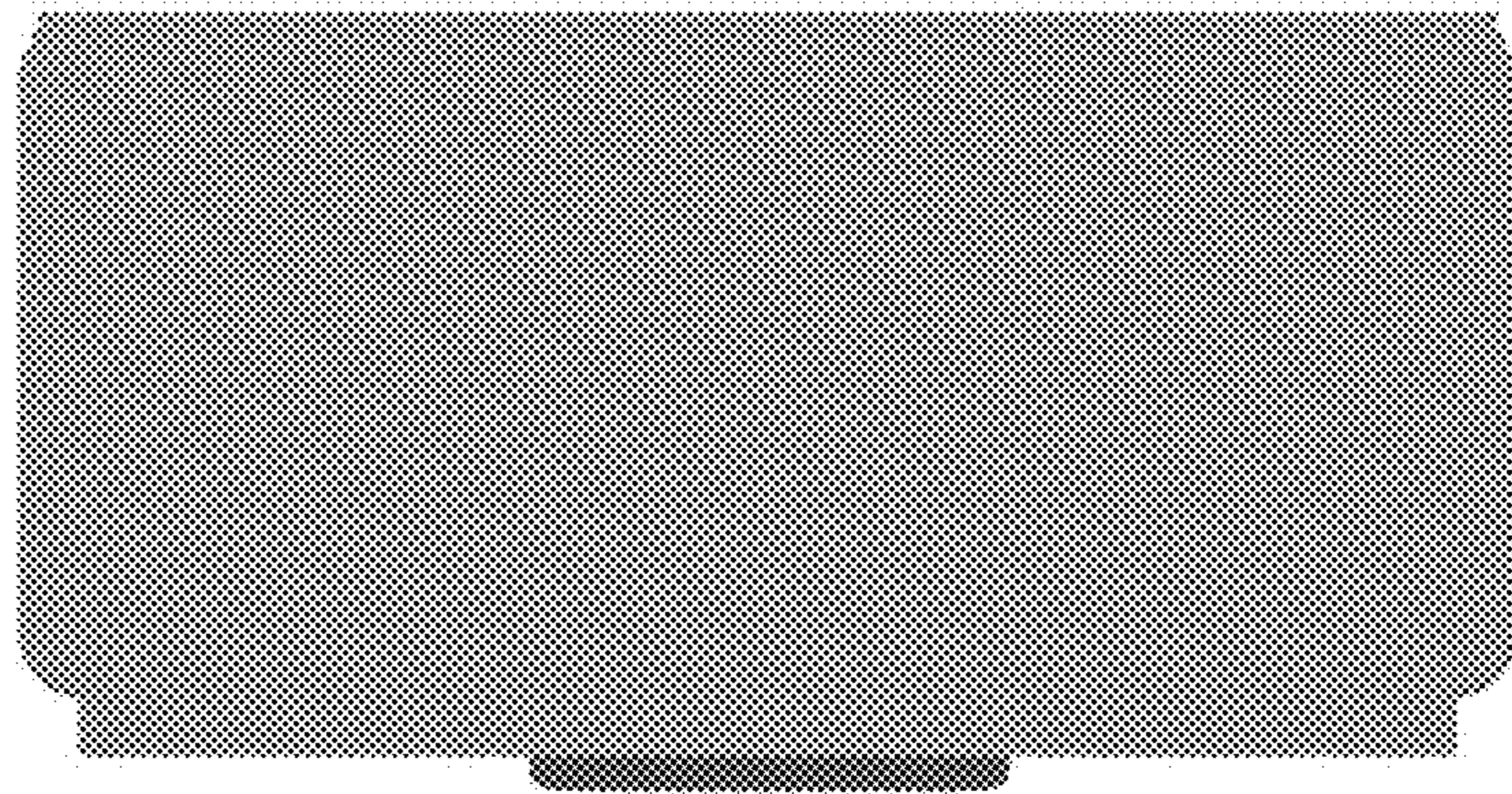

1.7

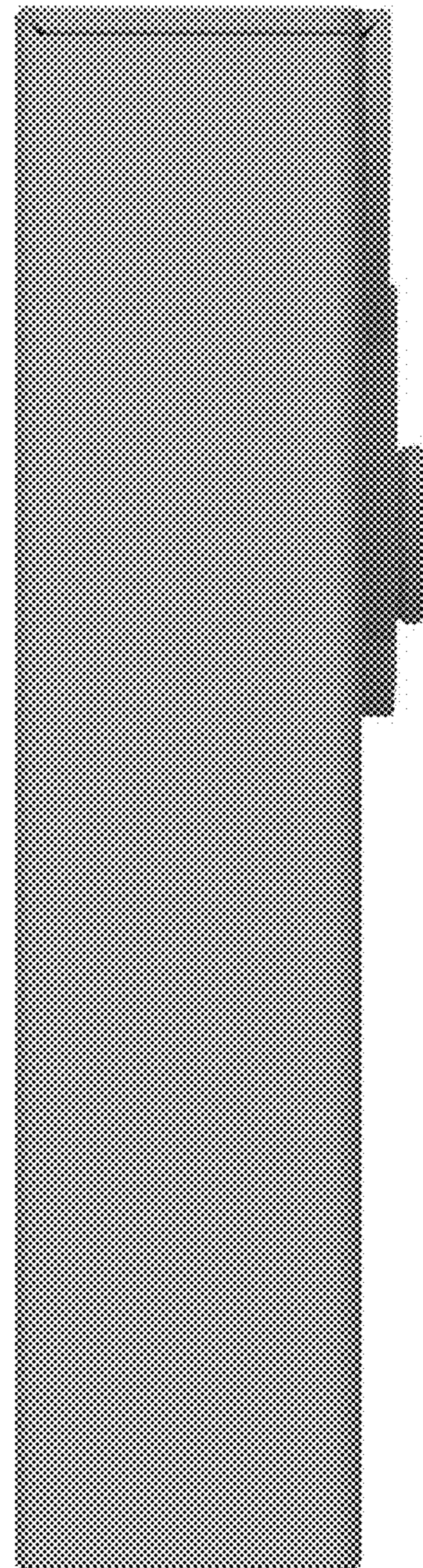



1.8

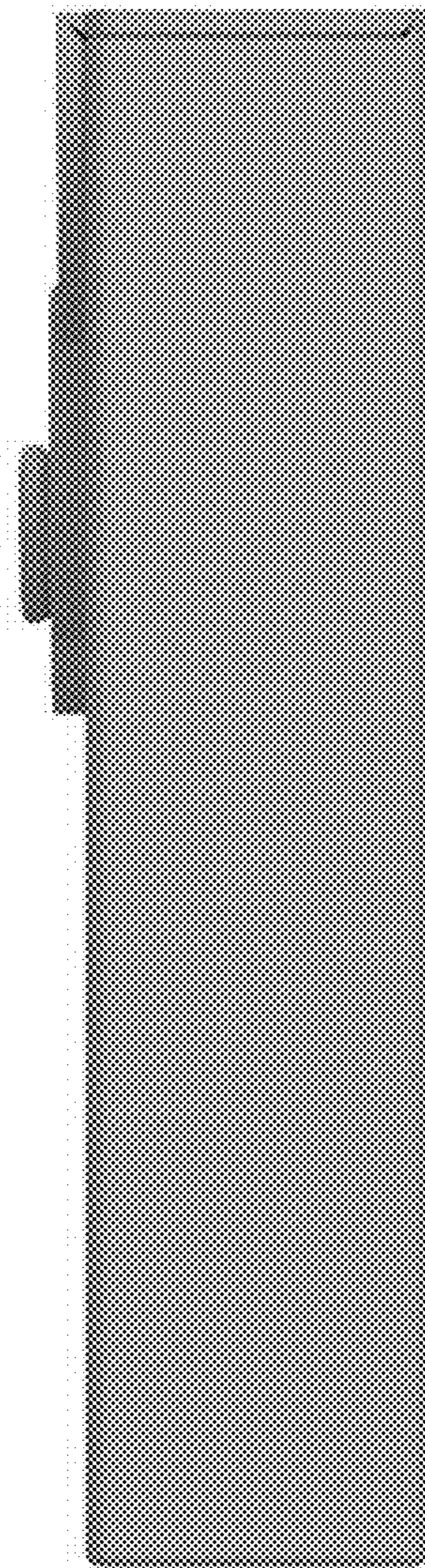

1.9

