



US00D926555S

(12) **United States Design Patent** (10) **Patent No.:** **US D926,555 S**  
**Martell** (45) **Date of Patent:** **\*\* Aug. 3, 2021**

(54) **LOCKING LATCH**

(71) Applicant: **Camlock Systems Limited**, East Sussex (GB)

(72) Inventor: **Chris C. A. Martell**, Wallingford, CT (US)

(73) Assignee: **Camlock Systems Limited**, East Sussex (GB)

(\*\*) Term: **15 Years**

(21) Appl. No.: **29/707,132**

(22) Filed: **Sep. 26, 2019**

(51) **LOC (13) Cl.** ..... **08-07**

(52) **U.S. Cl.**  
USPC ..... **D8/331**

(58) **Field of Classification Search**  
USPC ..... D8/331  
CPC ..... E05B 17/0004; E05B 17/04; E05B 55/00;  
E05B 57/00; E05B 59/00; E05B 61/00;  
E05B 81/01  
See application file for complete search history.

(56) **References Cited**

**U.S. PATENT DOCUMENTS**

1,688,240 A *	10/1928	Keigwin	.....	E05B 13/004
				292/169.16
4,370,874 A *	2/1983	Munn	.....	E05B 5/00
				292/204
5,145,221 A *	9/1992	Pennebaker	.....	E05B 17/2034
				292/146

(Continued)

*Primary Examiner* — Doris Clark

(74) *Attorney, Agent, or Firm* — Egan, Enders & Huston LLP.

(57) **CLAIM**

The ornamental design for a locking latch, as shown and described.

**DESCRIPTION**

FIG. 1 is a top plan view of one embodiment of a locking latch showing our new design;  
 FIG. 2 is a right elevational view of the locking latch of FIG. 1;  
 FIG. 3 is a rear elevational view of the locking latch of FIG. 1;  
 FIG. 4 is a left elevational view of the locking latch of FIG. 1;  
 FIG. 5 is a bottom plan view of the locking latch of FIG. 1;  
 FIG. 6 is a front perspective view of the locking latch of FIG. 1;  
 FIG. 7 is a front elevational view of the locking latch of FIG. 1;  
 FIG. 8 is a rear perspective view of the locking latch of FIG. 1;  
 FIG. 9 is a top plan view of a second embodiment of a locking latch showing our new design;  
 FIG. 10 is a right elevational view of the locking latch of FIG. 9;  
 FIG. 11 is a rear elevational view of the locking latch of FIG. 9;  
 FIG. 12 is a left elevational view of the locking latch of FIG. 9;  
 FIG. 13 is a bottom plan view of the locking latch of FIG. 9;  
 FIG. 14 is a front perspective view of the locking latch of FIG. 9;  
 FIG. 15 is a front elevational view of the locking latch of FIG. 9; and,  
 FIG. 16 is a rear perspective view of the locking latch of FIG. 9.

The surface shading lines on the figures are provided only to indicate the contour or curvature of the surfaces. They do not indicate color, texture, markings, indicia, graphic representations, surface treatment, or any other ornamentation applied to the article.

**1 Claim, 2 Drawing Sheets**

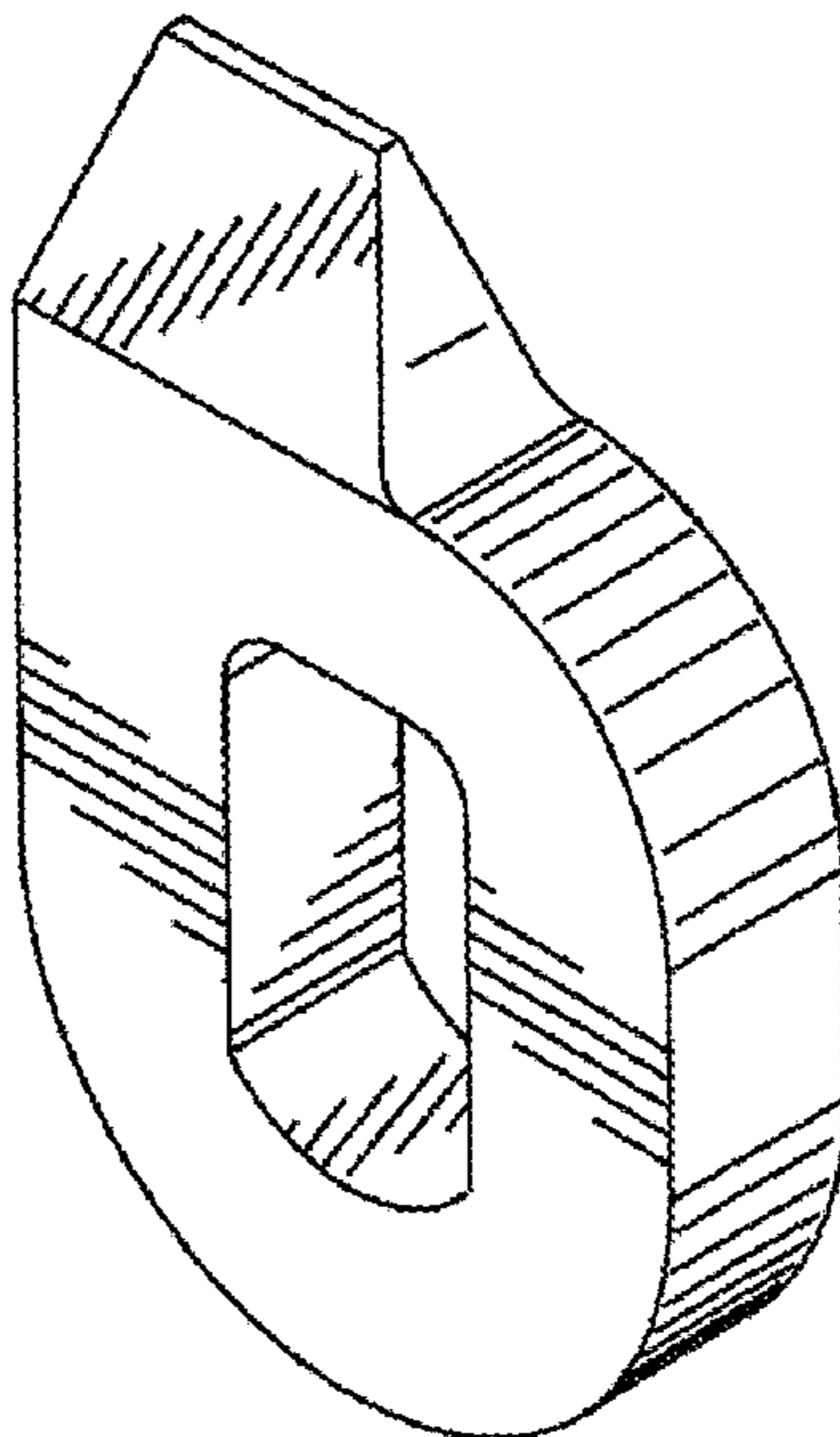

(56)

**References Cited**

U.S. PATENT DOCUMENTS

7,353,671 B2 \* 4/2008 Recknagel ..... B60D 1/60  
280/507  
D617,172 S 6/2010 DiVito  
7,827,836 B2 \* 11/2010 Cetnar ..... E05B 81/06  
70/257  
8,028,555 B2 \* 10/2011 Lurie ..... E05B 63/04  
70/371  
9,200,478 B2 \* 12/2015 Connell ..... E05C 3/145  
D756,745 S \* 5/2016 Kubota ..... D8/331  
D795,671 S \* 8/2017 Cordon ..... D8/331

\* cited by examiner

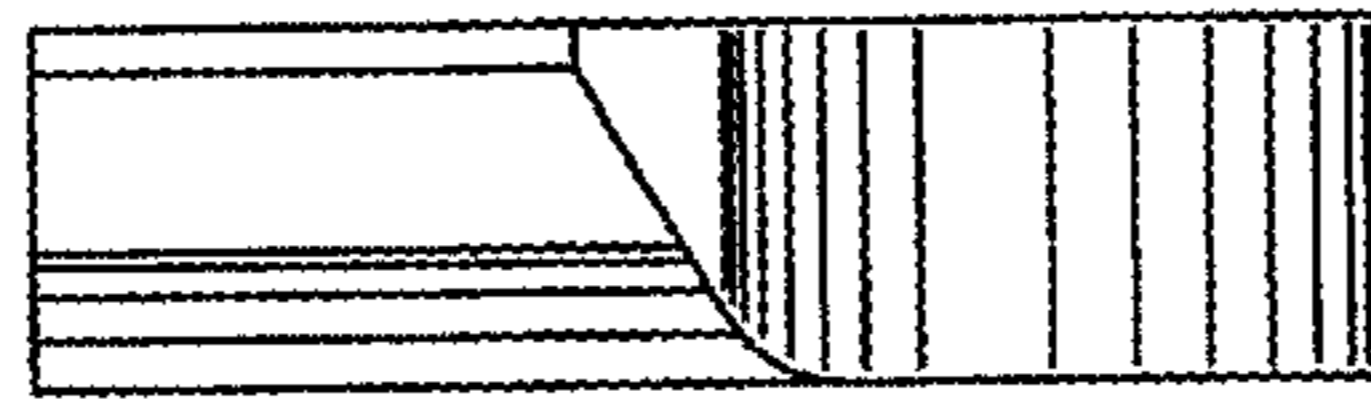

FIG. 1

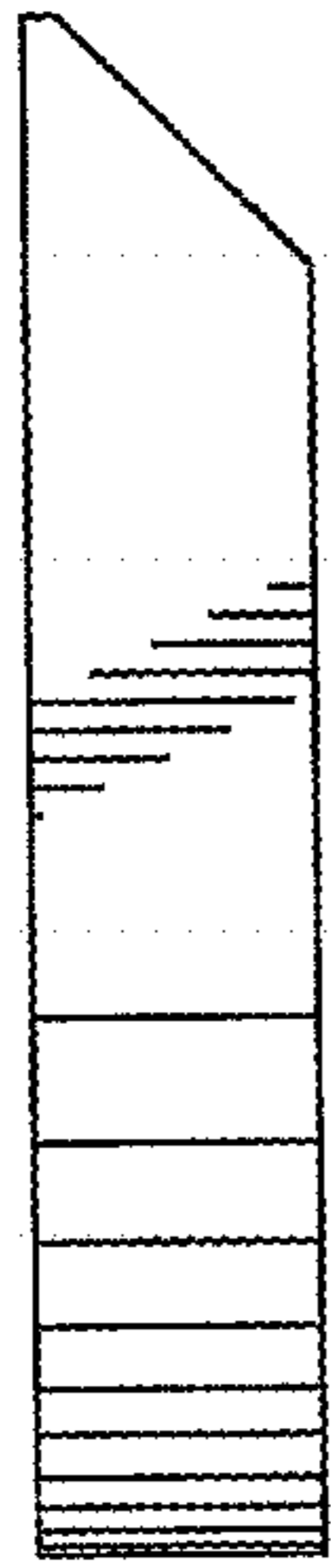

FIG. 2

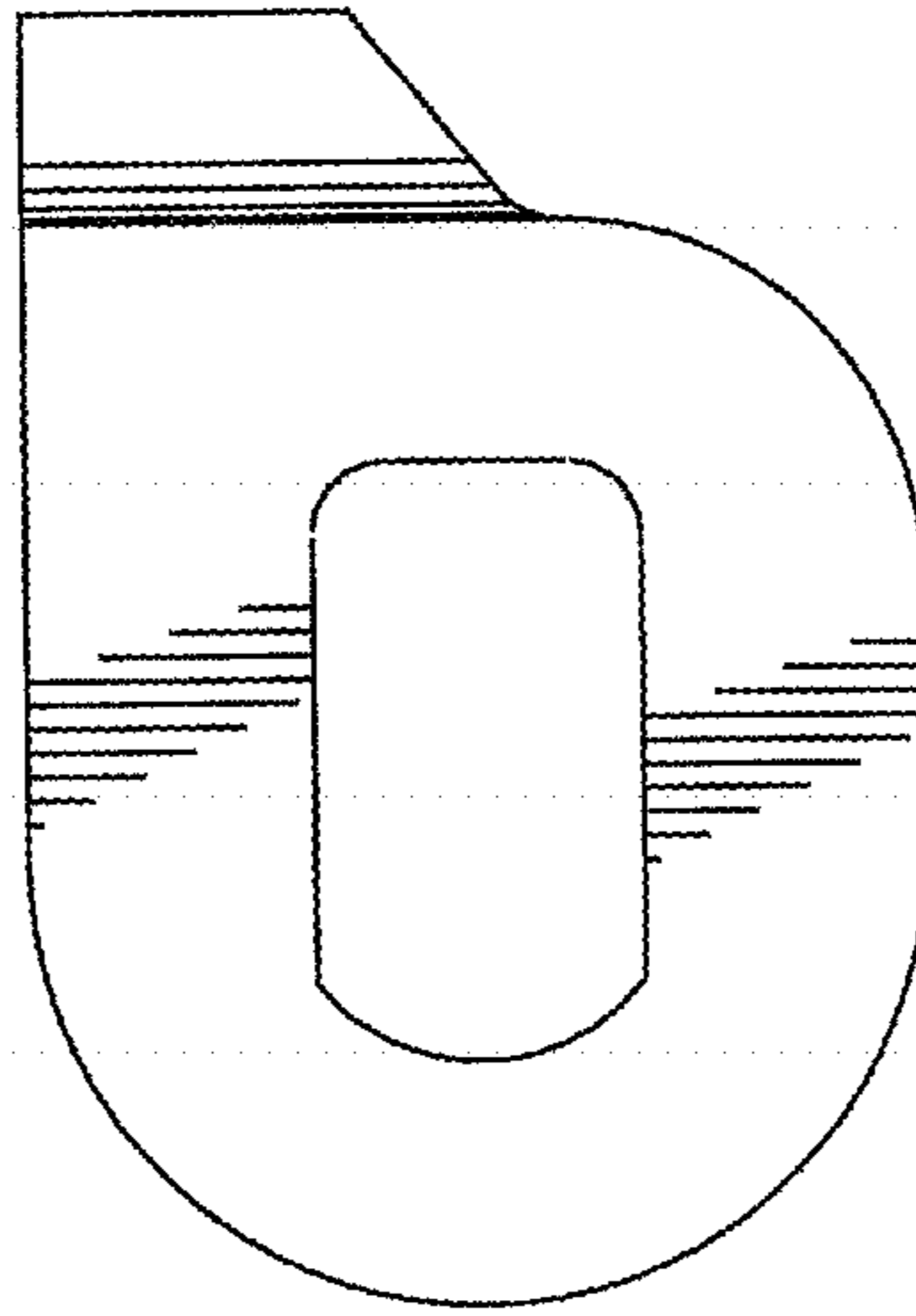

FIG. 3



FIG. 4

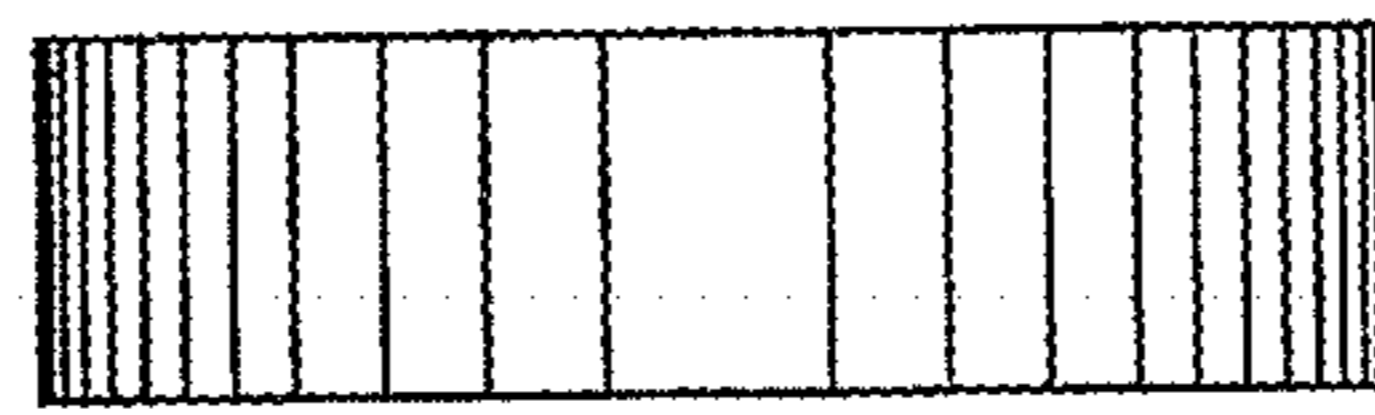

FIG. 5

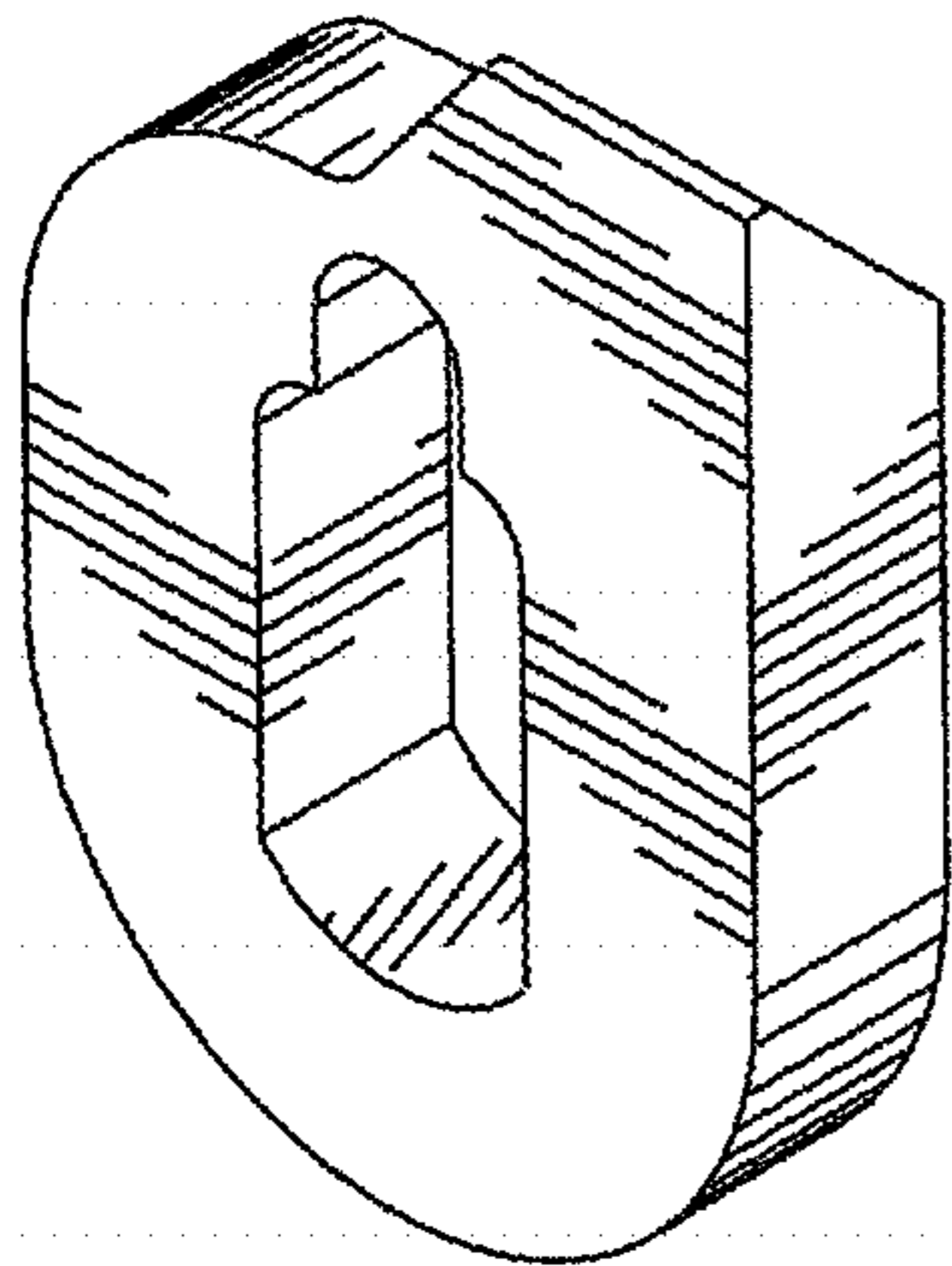

FIG. 6

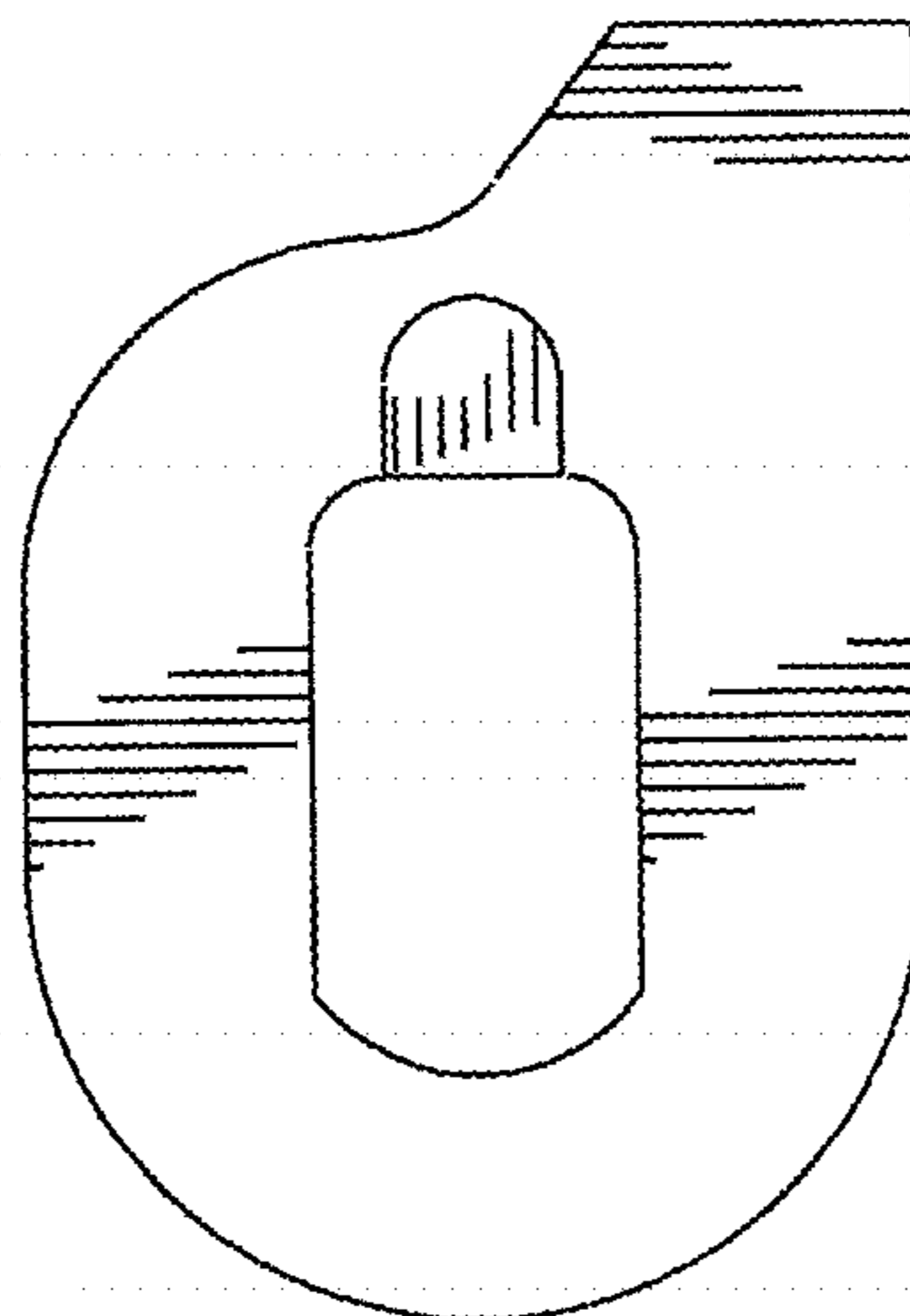

FIG. 7

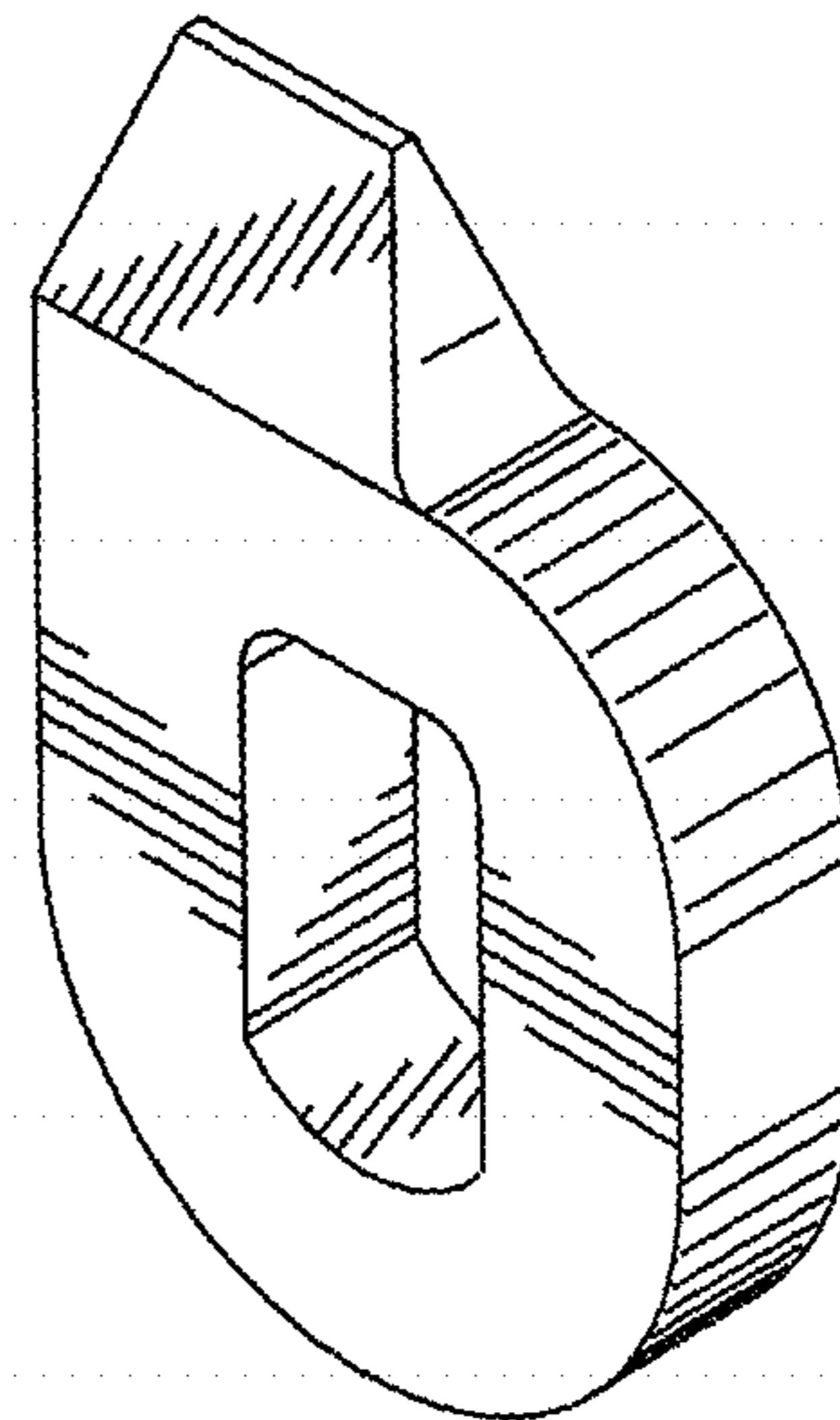

FIG. 8

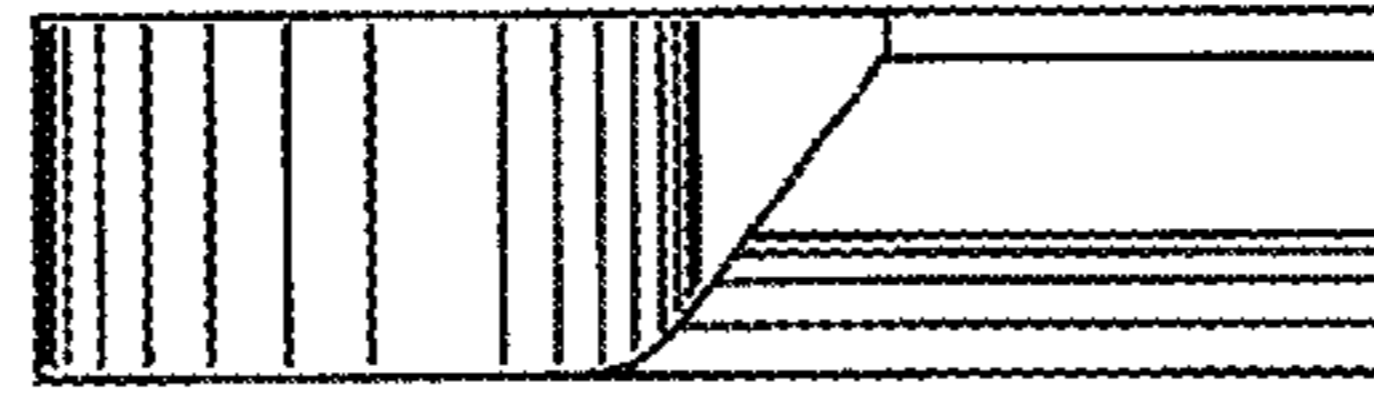

FIG. 9

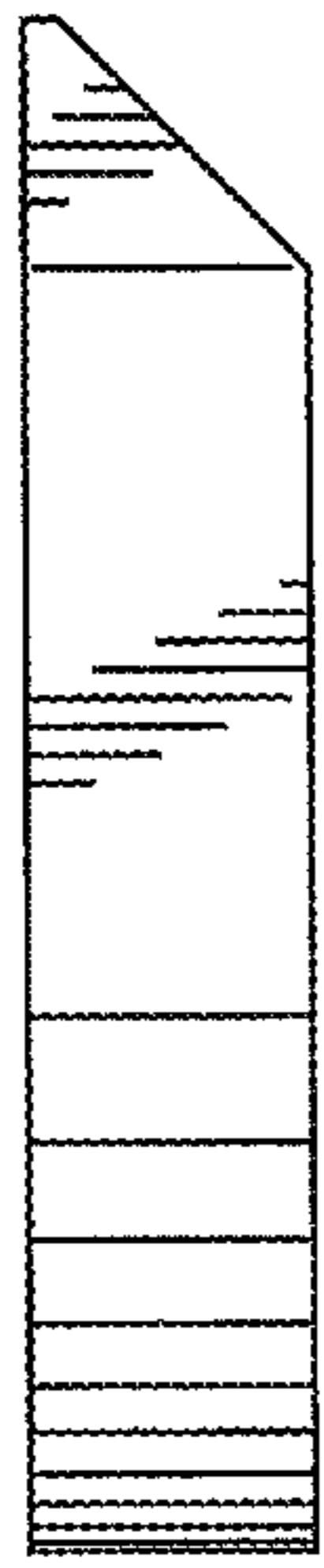

FIG. 10

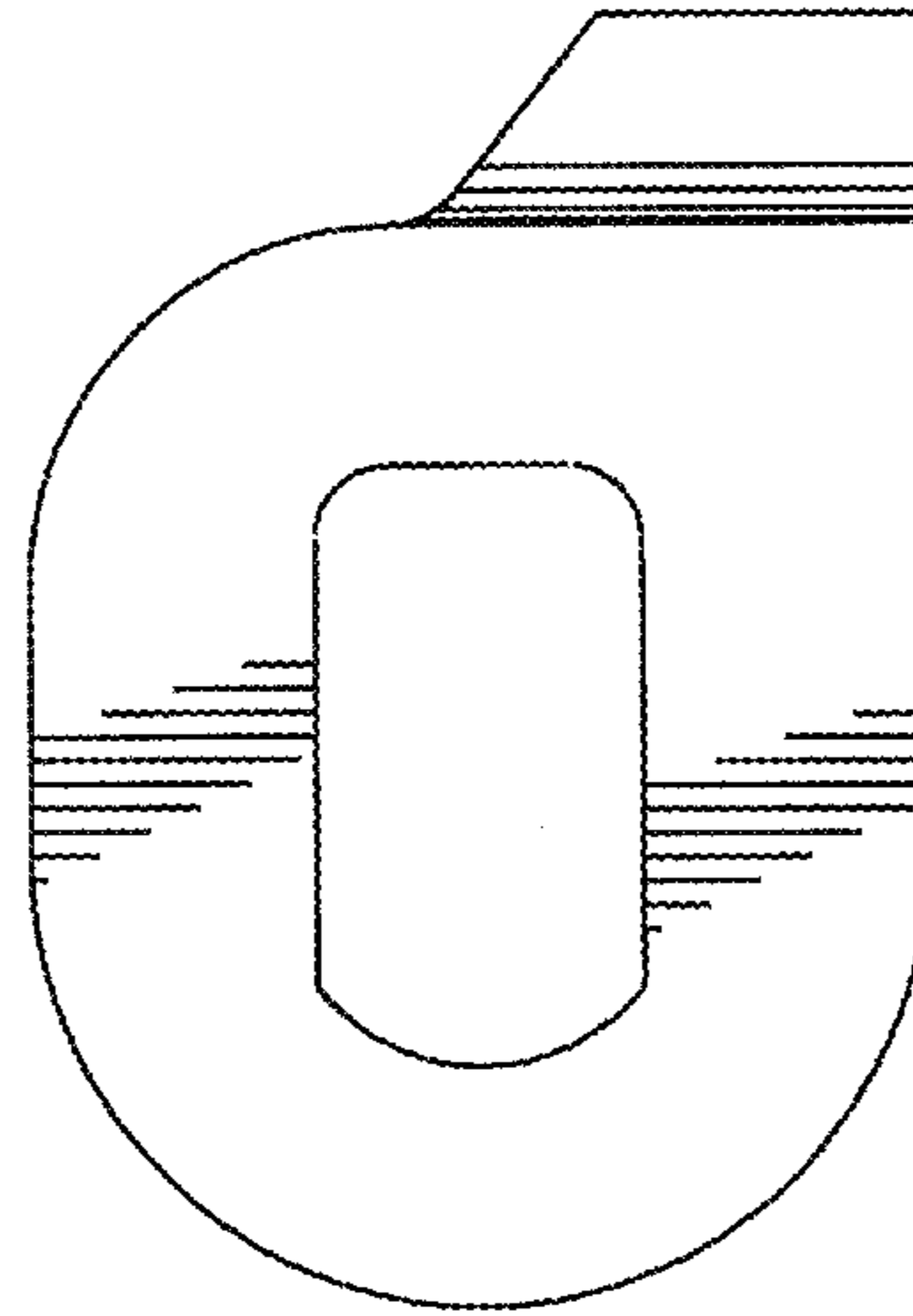

FIG. 11



FIG. 12

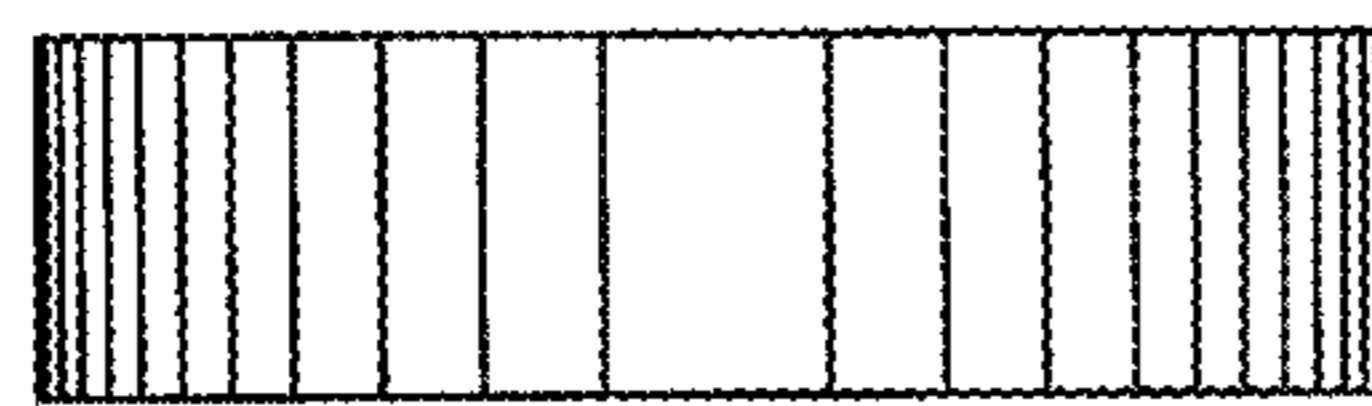

FIG. 13

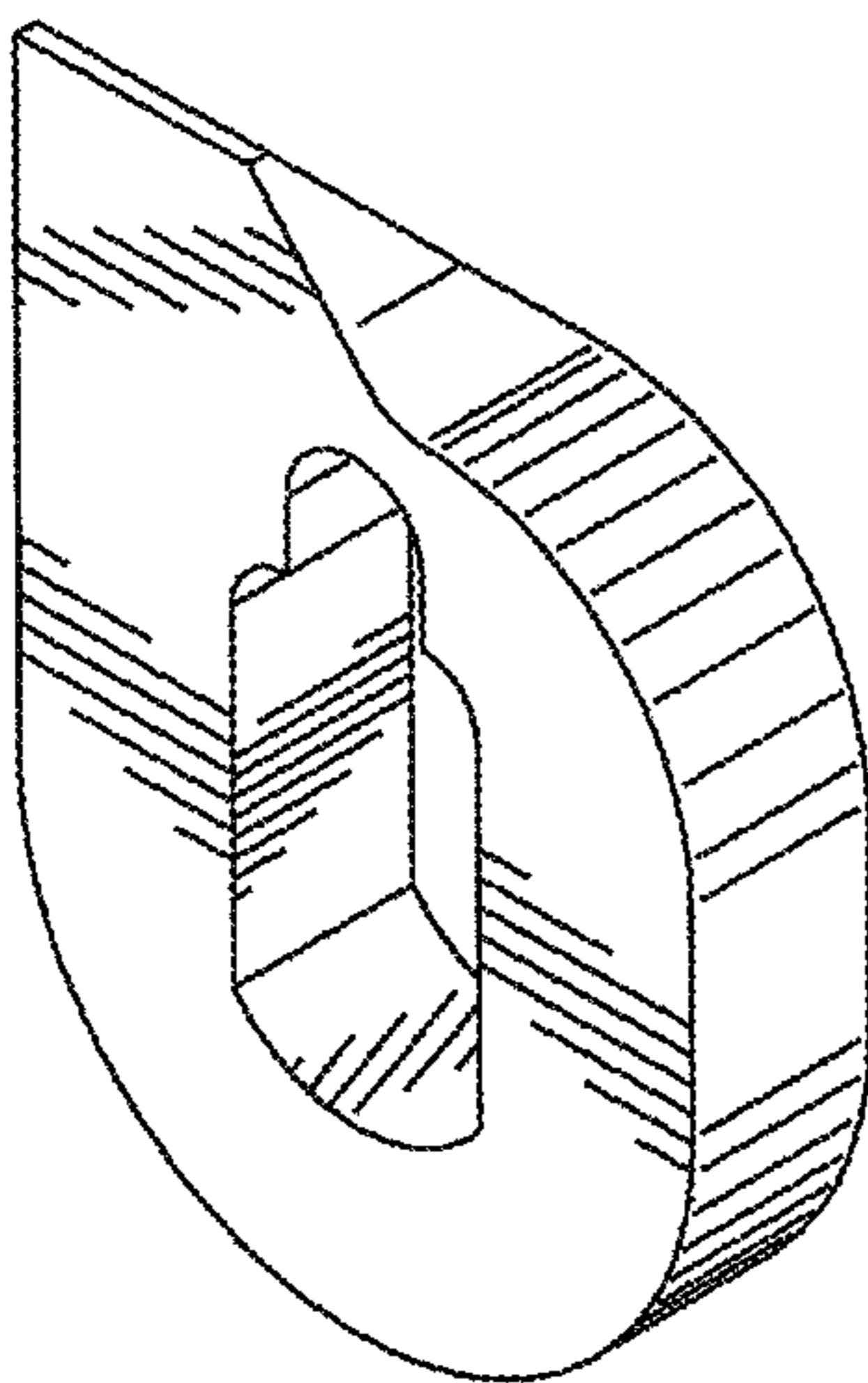

FIG. 14

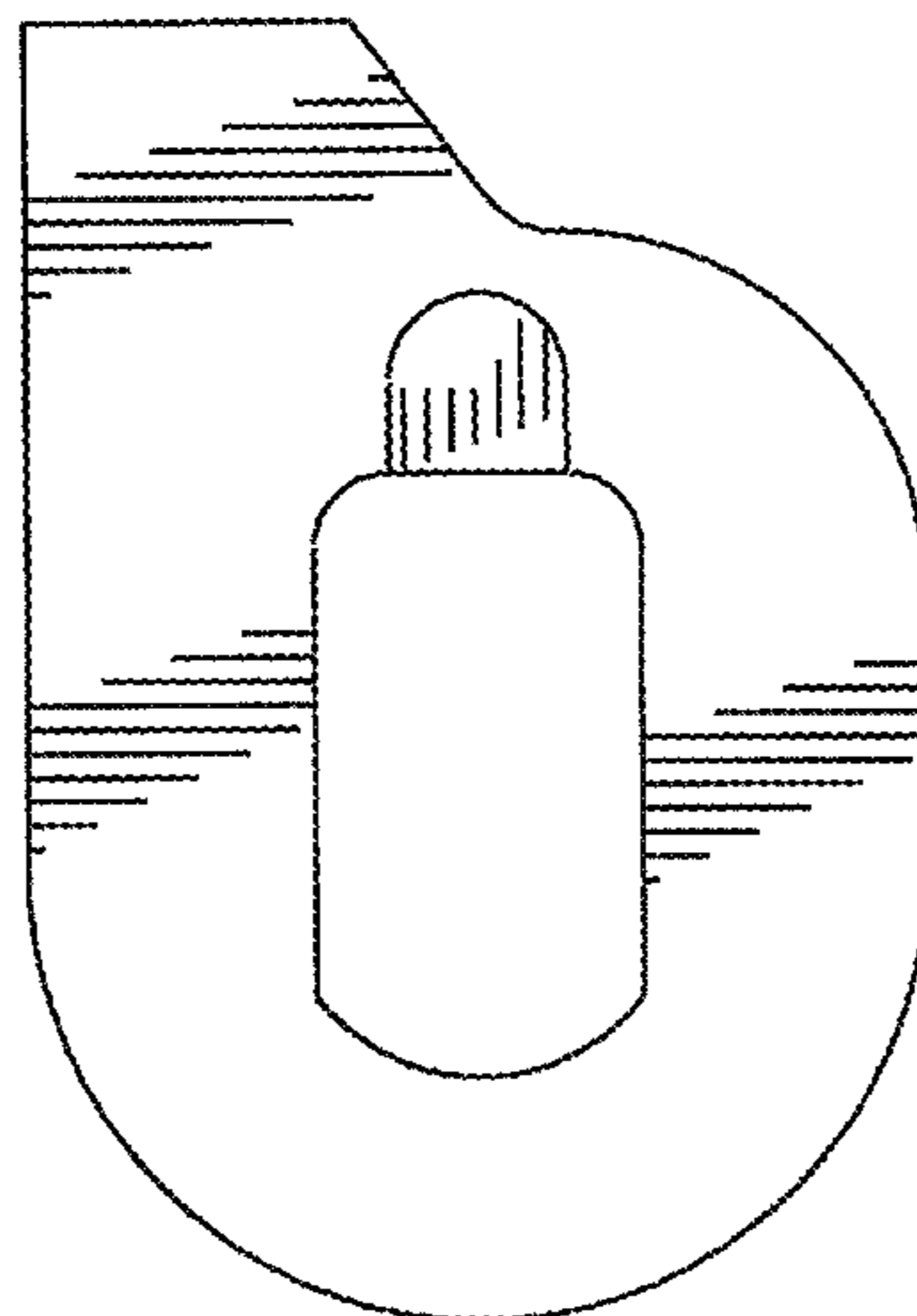

FIG. 15

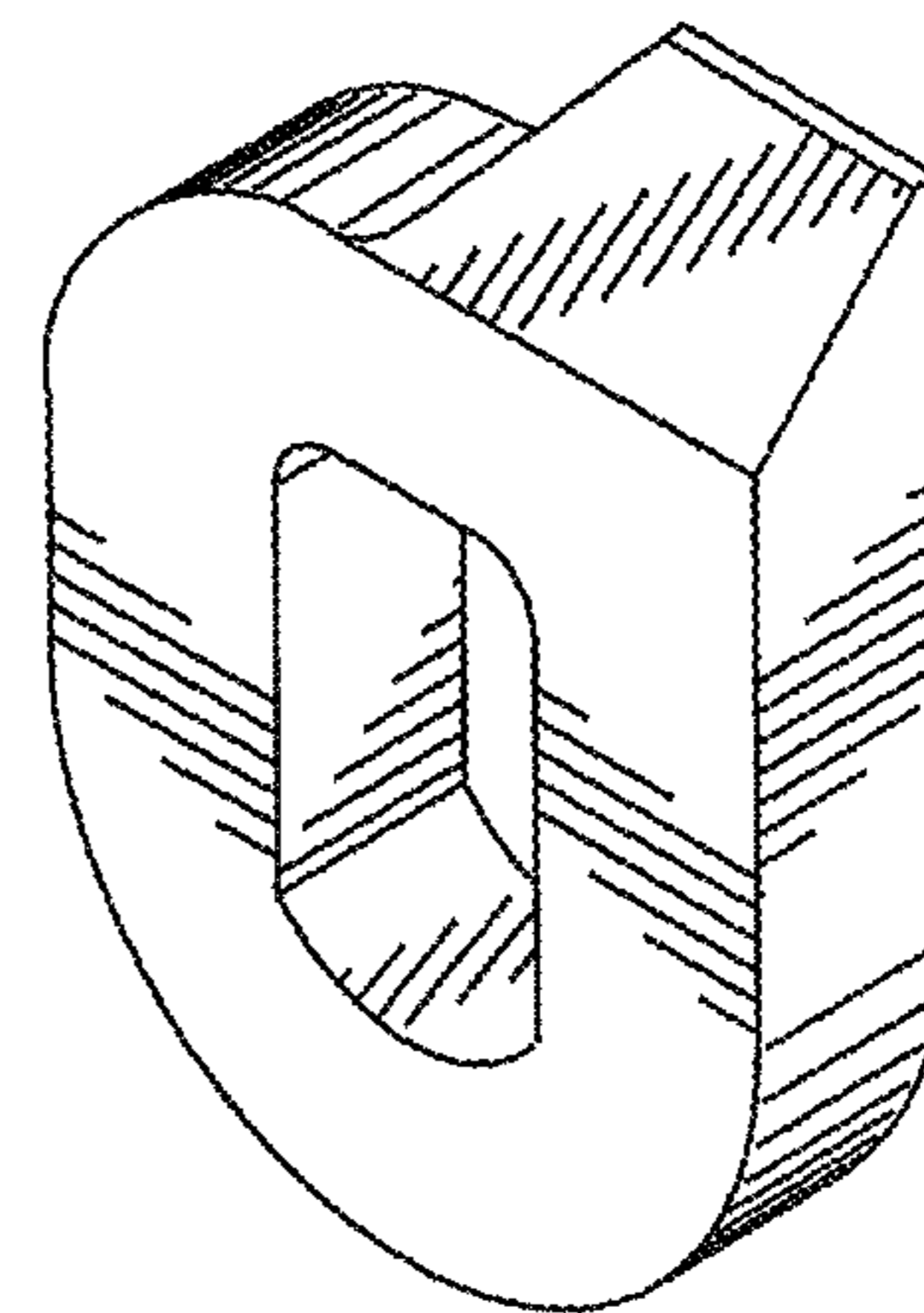

FIG. 16