



US00D926547S

(12) **United States Design Patent**  
**Ichikawa**

(10) **Patent No.:** **US D926,547 S**

(45) **Date of Patent:** **\*\* Aug. 3, 2021**

- (54) **BICYCLE TOOL**
- (71) Applicant: **BIB Creative Co., Ltd.**, Xiushui Township, Changhua County (TW)
- (72) Inventor: **Tomonari Ichikawa**, Xiushui Township (TW)
- (73) Assignee: **BIB Creative Co., Ltd.**, Xiushui Township (TW)
- (\*\*) Term: **15 Years**
- (21) Appl. No.: **29/715,069**
- (22) Filed: **Nov. 27, 2019**
- (51) **LOC (13) Cl.** ..... **08-05**
- (52) **U.S. Cl.**  
USPC ..... **D8/71; D8/105**
- (58) **Field of Classification Search**  
USPC ..... D8/17, 21, 28, 26, 71, 81, 105  
CPC ..... B25B 13/04; B25B 27/0071  
See application file for complete search history.

- 6,679,142 B1 \* 1/2004 Lin ..... B25B 13/56  
7/100
- D632,147 S \* 2/2011 Yang ..... D8/28
- D684,832 S \* 6/2013 Scott ..... D8/28
- D742,706 S \* 11/2015 Sui ..... D8/21
- D780,550 S \* 3/2017 Manor ..... D8/105
- D781,125 S \* 3/2017 Manor ..... D8/105
- D805,865 S \* 12/2017 Sui ..... D8/21
- D818,328 S \* 5/2018 Li ..... D8/17

\* cited by examiner

*Primary Examiner* — Janice Hallmark

*Assistant Examiner* — Harold E Blackwell, II

(74) *Attorney, Agent, or Firm* — Alan D. Kamrath; Karin L. Williams; Mayer & Williams PC

(57) **CLAIM**

The ornamental design for a bicycle tool, as shown and described.

**DESCRIPTION**

FIG. 1 is a perspective view of a bicycle tool, showing my new design;  
 FIG. 2 is a front view of the bicycle tool;  
 FIG. 3 is a top view of the bicycle tool;  
 FIG. 4 is a bottom view of the bicycle tool;  
 FIG. 5 is a close-up view of the claimed subject matter in FIG. 1;  
 FIG. 6 is a close-up view of the claimed subject matter in FIG. 1; and,  
 FIG. 7 is another perspective view of the bicycle tool.  
 The broken lines in the drawings are for the purpose of illustrating portions of the bicycle tool that form no part of the claimed design.

**1 Claim, 7 Drawing Sheets**

(56) **References Cited**

**U.S. PATENT DOCUMENTS**

- 1,475,834 A \* 11/1923 Kadow ..... B25B 13/465  
81/63
- 5,652,988 A \* 8/1997 Appelhoff ..... B25F 1/00  
7/151
- 5,655,242 A \* 8/1997 Chuang ..... B25B 13/04  
7/100
- 5,894,767 A \* 4/1999 Wridt ..... B25B 27/0071  
81/119
- D467,777 S \* 12/2002 Van Horn ..... D8/21

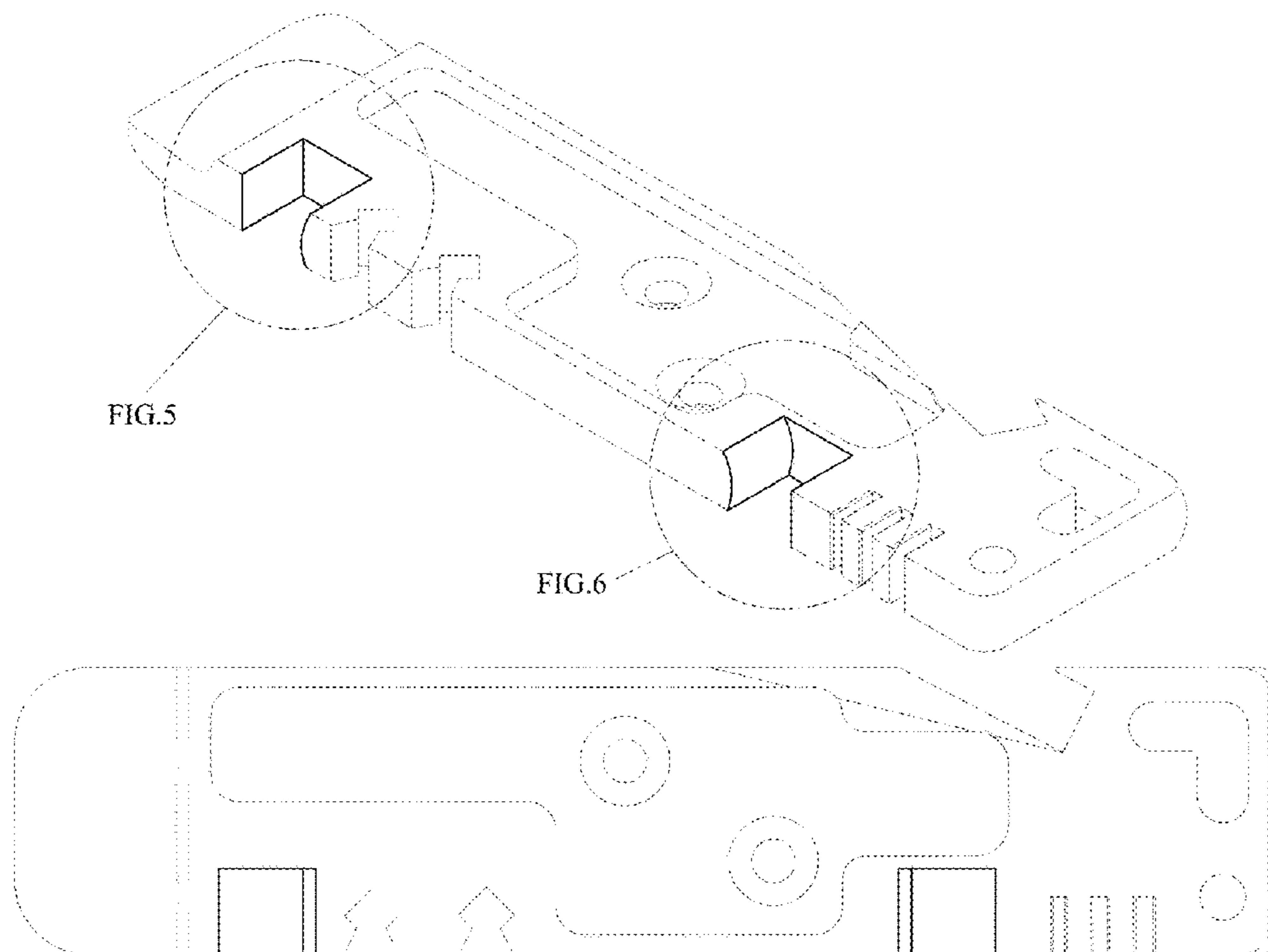

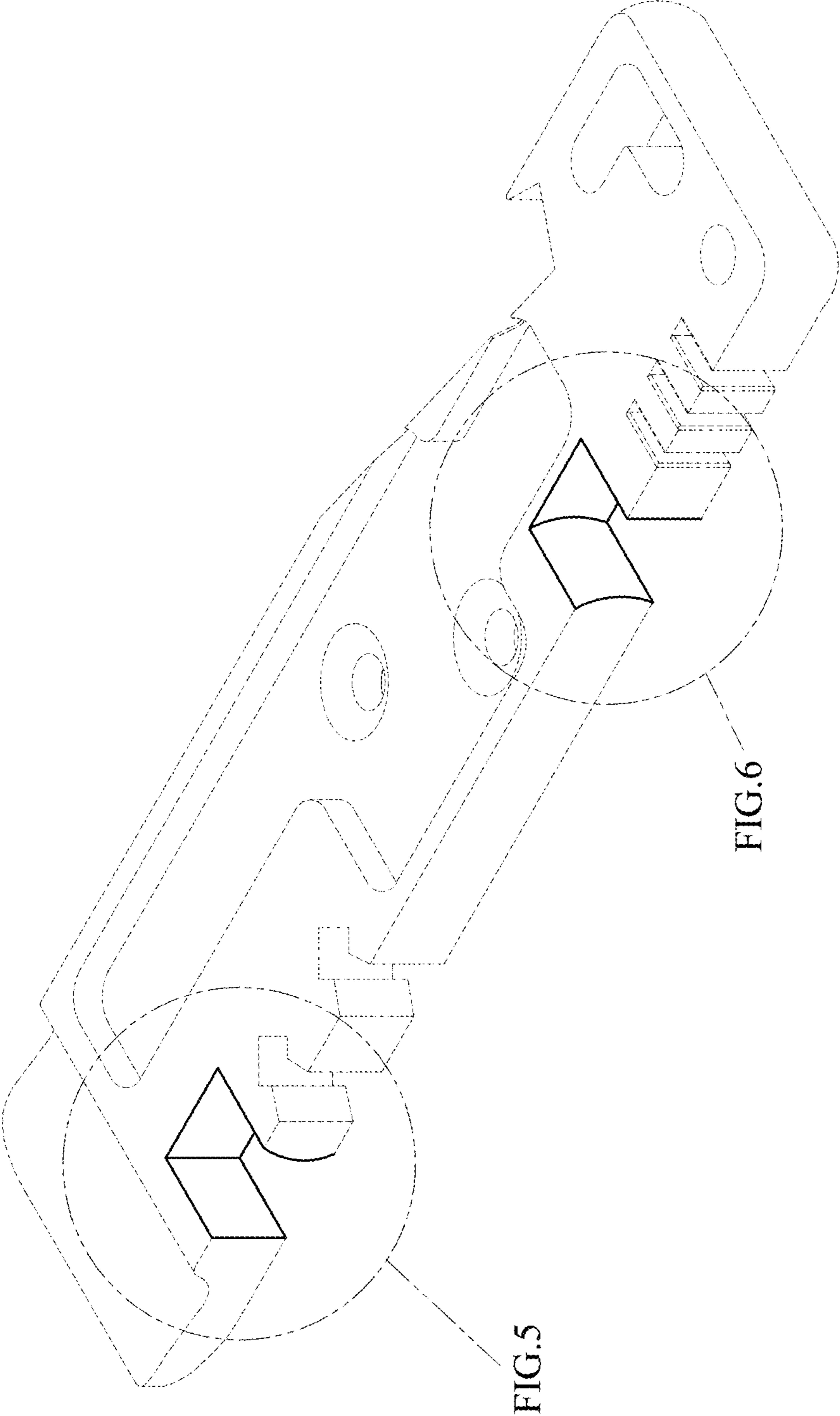

FIG. 1

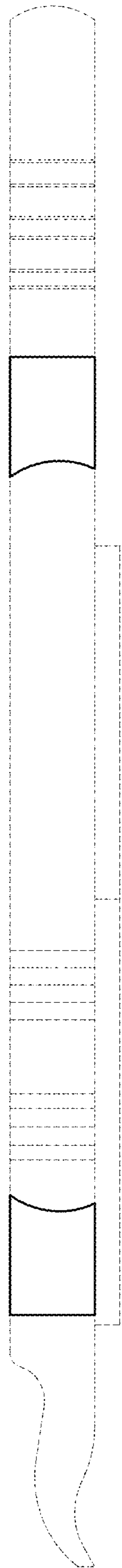

FIG. 2

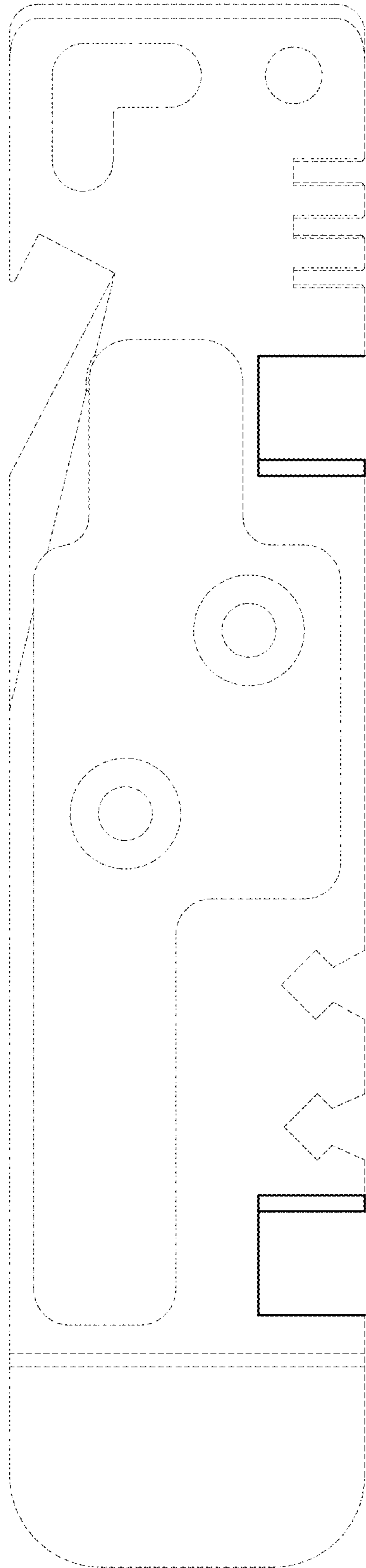

FIG. 3

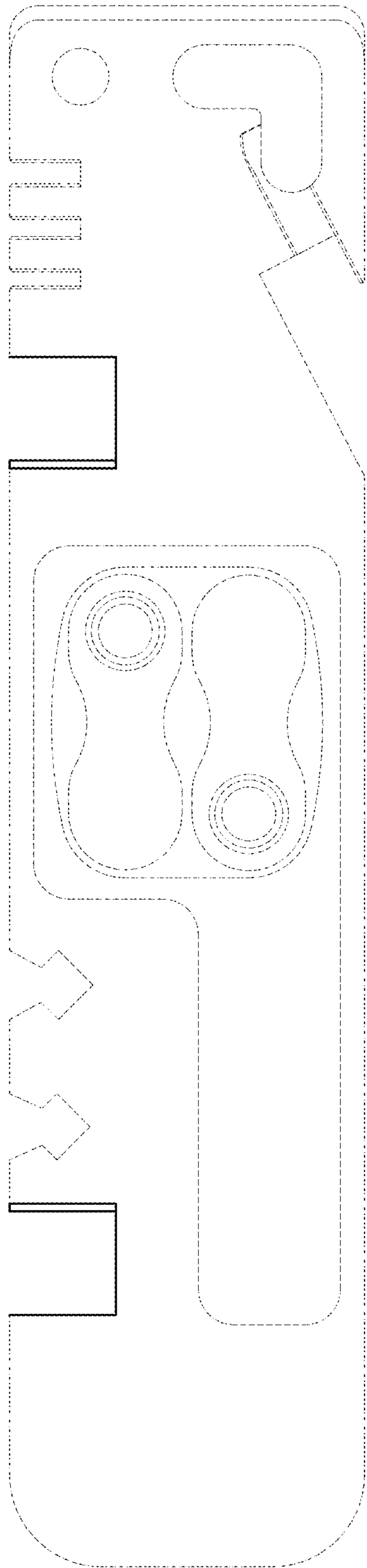

FIG. 4

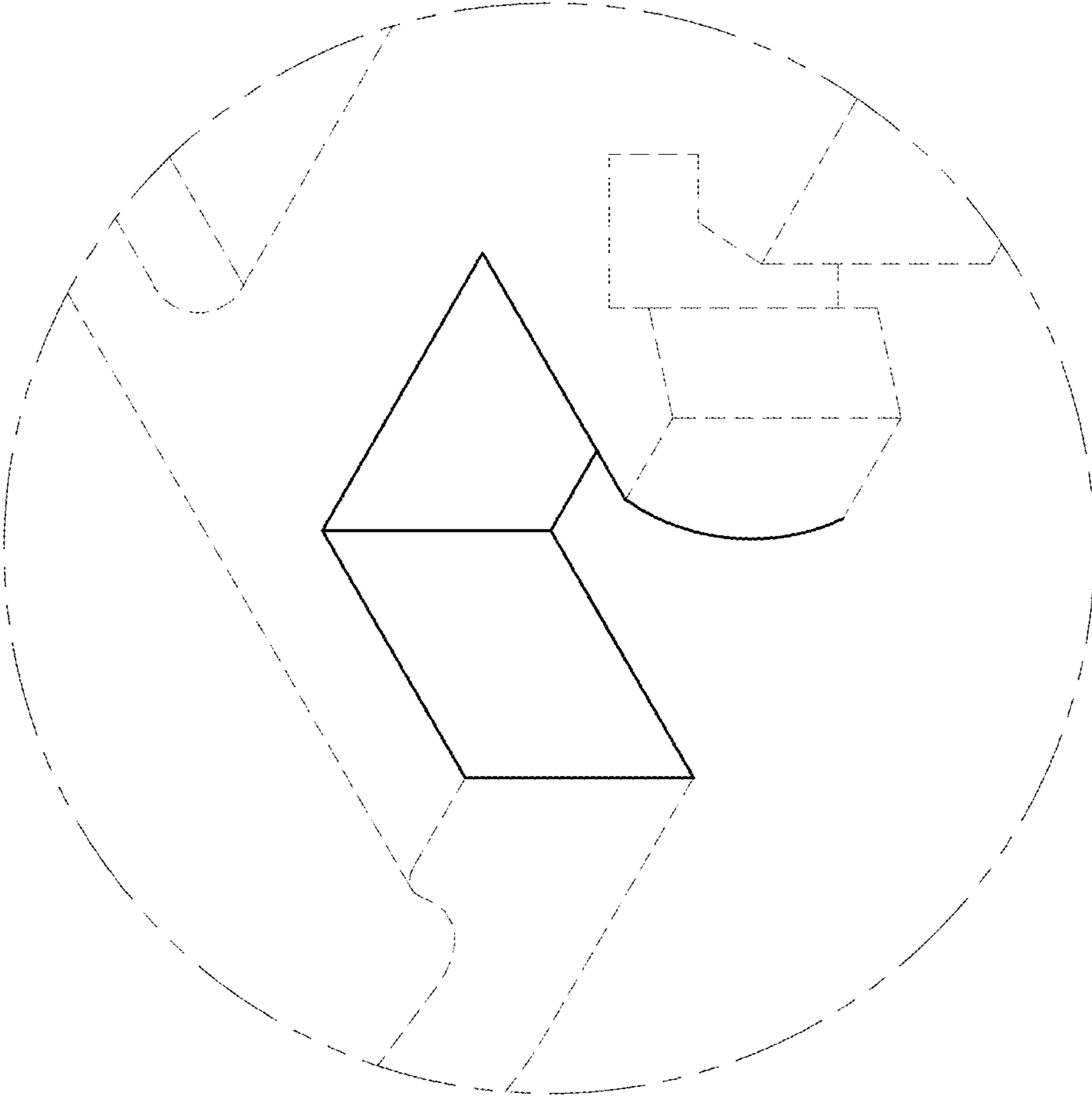

FIG. 5

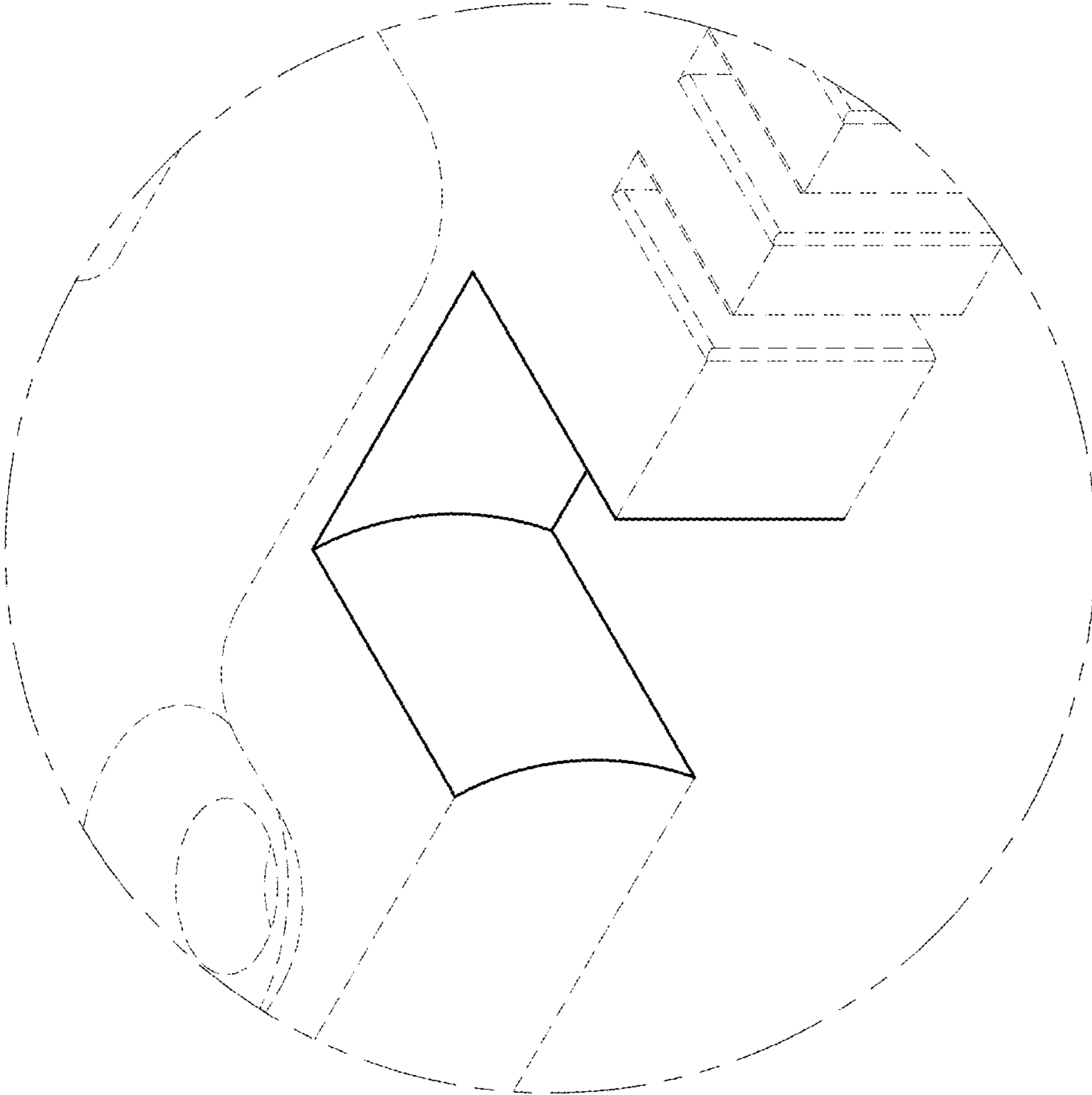

FIG. 6

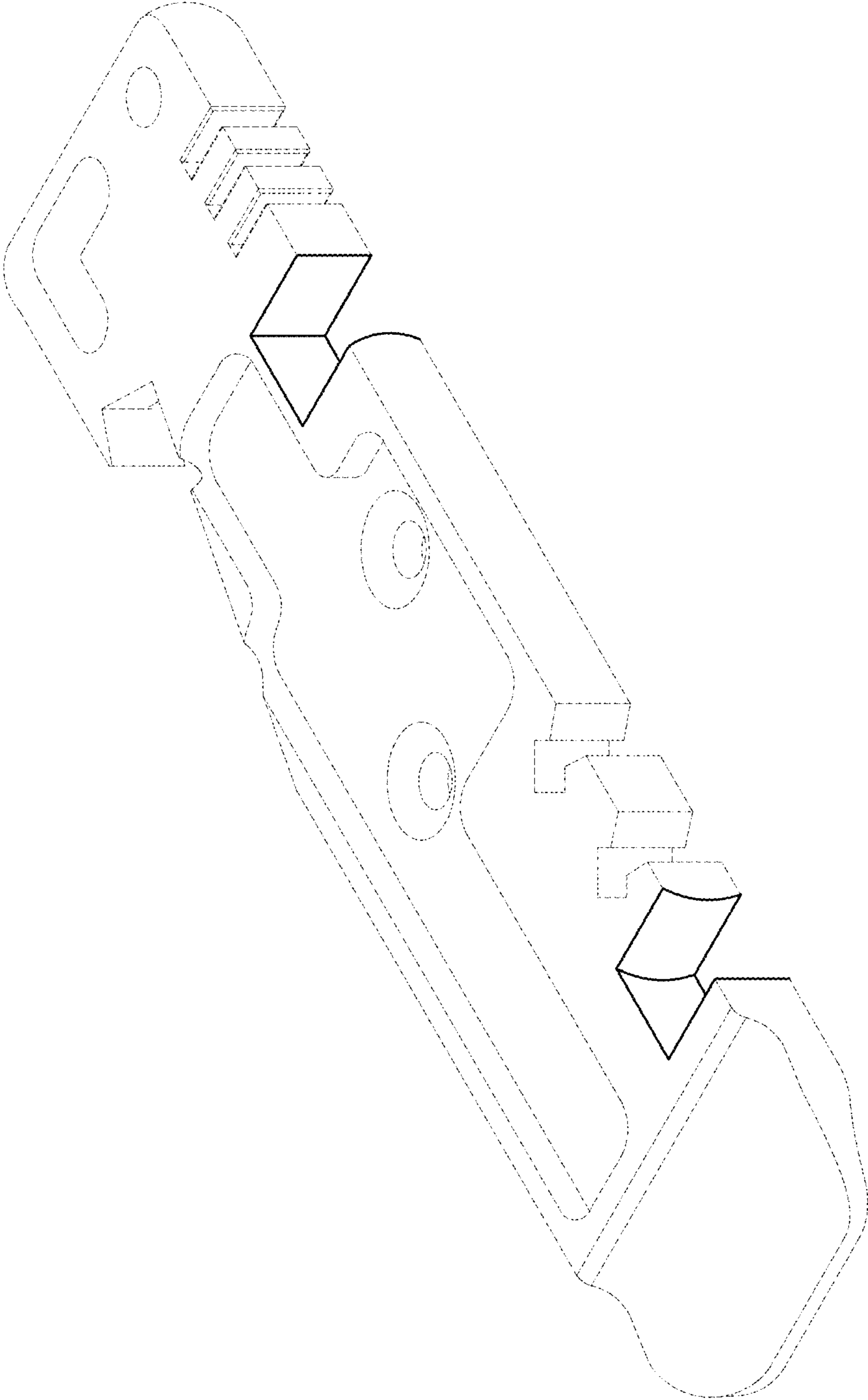

FIG. 7