



US00D926517S

(12) **United States Design Patent** (10) **Patent No.:** **US D926,517 S**
Liu (45) **Date of Patent:** **** Aug. 3, 2021**

(54) **KNIFE HANDLE**

(71) Applicant: **Yunxing Liu**, Irvine, CA (US)

(72) Inventor: **Yunxing Liu**, Irvine, CA (US)

(**) Term: **15 Years**

(21) Appl. No.: **29/727,579**

(22) Filed: **Mar. 11, 2020**

(51) **LOC (13) Cl.** **07-03**

(52) **U.S. Cl.**
USPC **D7/401.2**; D7/649

(58) **Field of Classification Search**
USPC D7/393-395, 401.2, 642-652, 693,
D7/695-696; D8/93, 97-100, 107, 300,
D8/321; D22/117-118
CPC A01B 1/20; A01B 1/22; A22C 25/006;
A47G 21/06; A47G 21/065; A61B
17/3211; A61B 17/3213; B21D 53/64;
B25G 3/36; B26B 1/00; B26B 1/08;
B26B 1/10; B26B 3/00; B26B 3/02;
B26B 3/03; B26B 3/04; B26B 3/06;
B26B 5/00; B26B 5/001; B26B 5/007;
B26B 7/00; B26B 7/005; B26B 9/00;
B26B 9/02; B26B 11/00; B26B 11/006;
B26B 17/00; B26B 17/006; B26B 27/00;
B26B 29/02; B25B 9/02

See application file for complete search history.

(56) **References Cited**

U.S. PATENT DOCUMENTS

D274,399 S *	6/1984	Olsen, Jr.	D7/649
D649,411 S *	11/2011	Lo	D7/649
D773,891 S *	12/2016	Liu	D7/401.2
D807,696 S *	1/2018	Liu	D7/401.2
D809,339 S *	2/2018	Lo	D7/401.2
D831,419 S *	10/2018	Liu	D7/401.2
D881,644 S *	4/2020	Liu	D7/401.2
D906,063 S *	12/2020	Gabbay	D7/650
D920,056 S *	5/2021	Chen	D7/649

* cited by examiner

Primary Examiner — Ricky Pham

(57) **CLAIM**

The ornamental design for a knife handle, as shown and described.

DESCRIPTION

FIG. 1 is a front, left side perspective of a knife handle, showing my new design.
FIG. 2 is a left side view thereof, the right side being a mirror image.
FIG. 3 is a top view thereof.
FIG. 4 is a bottom view thereof.
FIG. 5 is a rear view thereof; and,
FIG. 6 is a front view thereof.
The broken lines shown in the drawings are for illustrative purposes only and form no part of the claimed design.

1 Claim, 3 Drawing Sheets

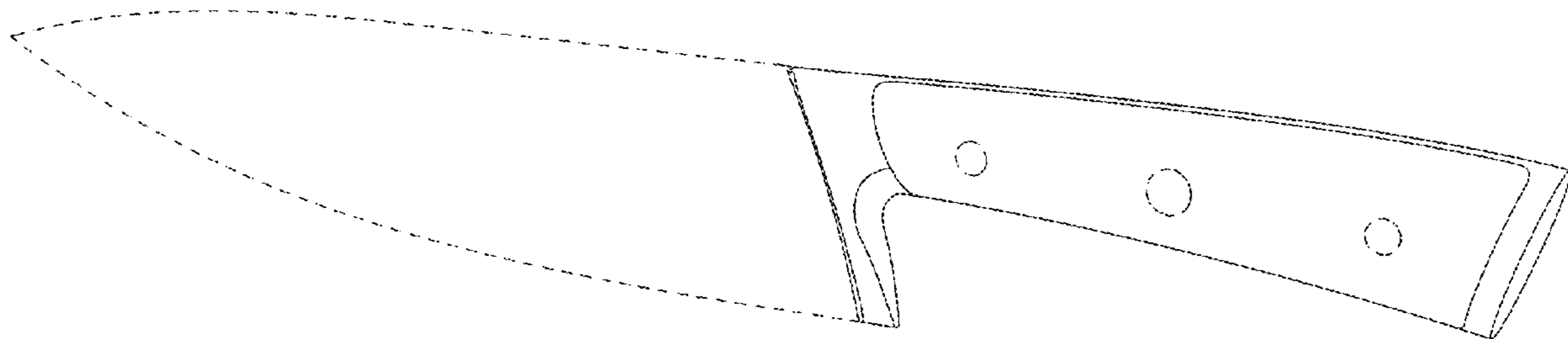

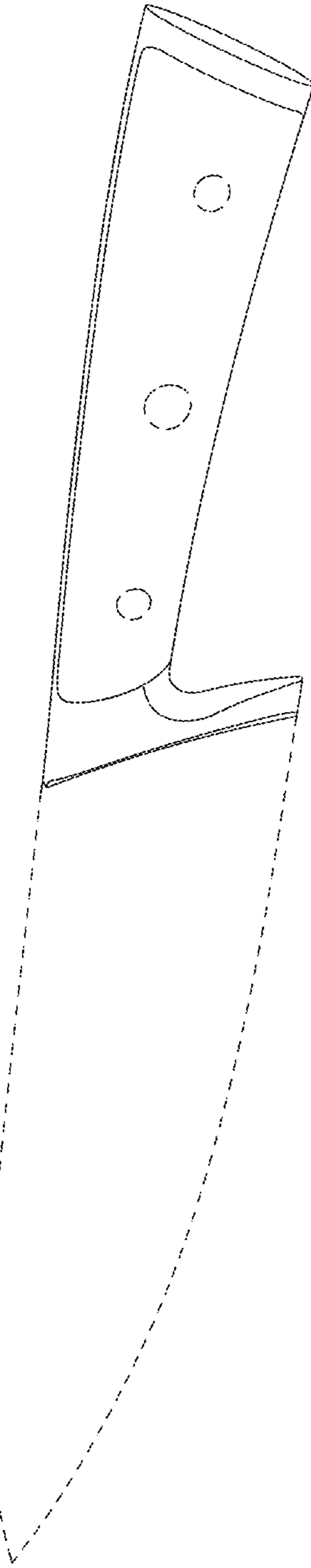

Fig. 1

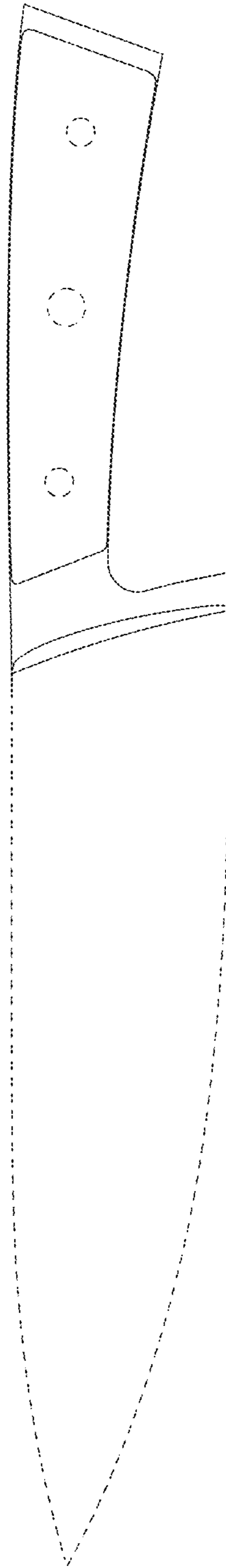

Fig. 2

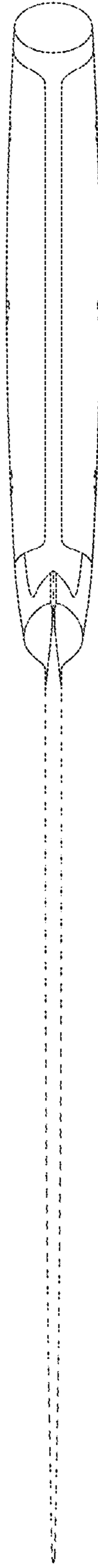

Fig. 3

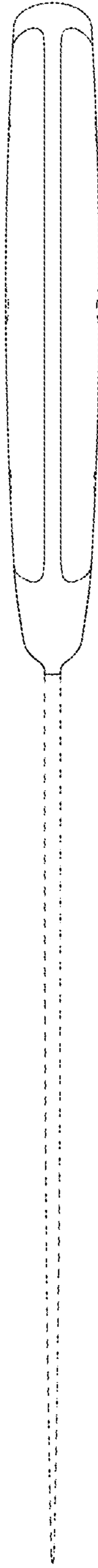

Fig. 4

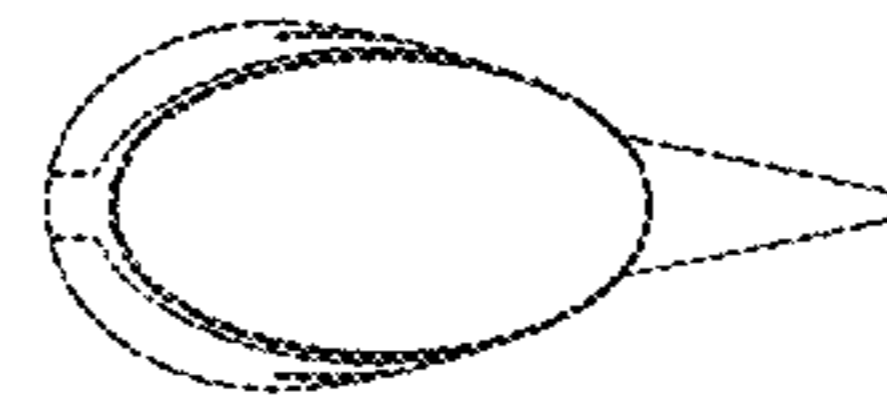

Fig. 5

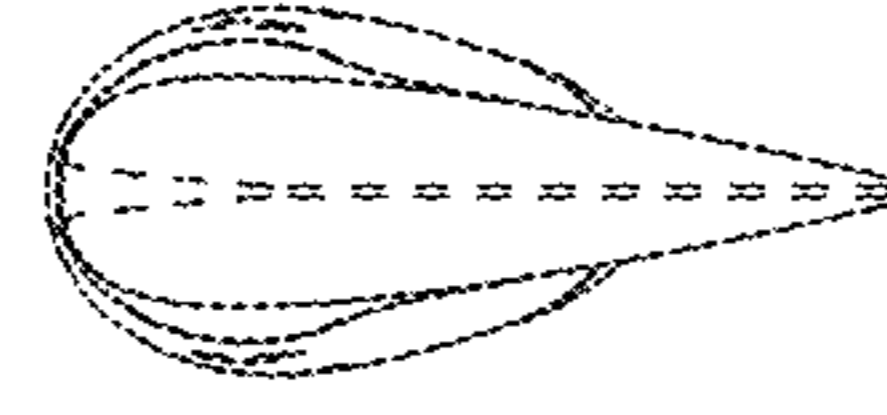

Fig. 6