



US00D926380S

(12) **United States Design Patent** (10) **Patent No.:** **US D926,380 S**  
**Wolfe et al.** (45) **Date of Patent:** **\*\* Jul. 27, 2021**

(54) **CYLINDRICAL COSMETIC CONTAINER WITH MAGNETIC CLOSURE**

FOREIGN PATENT DOCUMENTS

(71) Applicant: **Cosmopak U.S.A. LLC**, Port Washington, NY (US)

CN 202514864 11/2012  
WO WO-2018037170 A1 \* 3/2018 ..... A45C 13/1069

(72) Inventors: **Daniel Wolfe**, New York, NY (US); **Matthew Wolfe**, New York, NY (US); **Barnett Wolfe**, Port Washington, NY (US); **Walter Dwyer**, Pacific Palisades, CA (US)

OTHER PUBLICATIONS

Quick Release Magnetic Vial by Cosmopak USA LLC, published Oct. 1, 2018, retrieved on Apr. 6, 2021, retrieved from the Internet URL: <https://www.gcimagazine.com/business/manufacturing/packaging/Quick-Release-Magnetic-Vial-by-Cosmopak-USA-LLC-494828361.html>.\*

(73) Assignee: **COSMOPAK U.S.A. LLC**, Port Washington, NY (US)

(Continued)

(\*\*) Term: **15 Years**

*Primary Examiner* — Jennifer Rivard  
*Assistant Examiner* — Alison M Ofstun

(21) Appl. No.: **29/724,471**

(74) *Attorney, Agent, or Firm* — Holzer Patel Drennan

(22) Filed: **Feb. 14, 2020**

**Related U.S. Application Data**

(57) **CLAIM**

(62) Division of application No. 29/655,654, filed on Jul. 5, 2018, now Pat. No. Des. 904,691.

The ornamental design for a cylindrical cosmetic container with magnetic closure, as shown and described.

(51) **LOC (13) Cl.** ..... **28-03**

(52) **U.S. Cl.**  
USPC ..... **D28/76**

**DESCRIPTION**

(58) **Field of Classification Search**  
USPC ..... D28/4, 8.1, 9, 76, 85-90, 91.1, 99;  
D9/451, 629, 503-504, 500, 529, 575,  
D9/686, 723

FIG. 1 is a front perspective view of a cylindrical cosmetic container with magnetic closure in a closed position.

FIG. 2 is a front perspective view of the cylindrical cosmetic container with magnetic closure in an open position.

CPC ..... A45D 33/22; A45D 33/24; A45D 33/26;  
A45D 33/28; A45D 40/00; A45D 40/20;  
A45D 40/24; A45D 34/00; A45D 34/04;

FIG. 3 is a front elevation view of the cylindrical cosmetic container with magnetic closure in the open position, of which the rear elevation, right side elevation, and left side elevation are mirror images thereto.

(Continued)

FIG. 4 is a top plan view of the cylindrical cosmetic container with magnetic closure; and,

FIG. 5 is a bottom plan view of the cylindrical cosmetic container with magnetic closure.

(56) **References Cited**

**U.S. PATENT DOCUMENTS**

3,941,489 A \* 3/1976 Bryan ..... A45D 40/026  
401/59

The broken lines in the figures represent portions of the article which form no part of the claimed design.

D279,510 S 7/1985 Kairawicz  
(Continued)

**1 Claim, 3 Drawing Sheets**

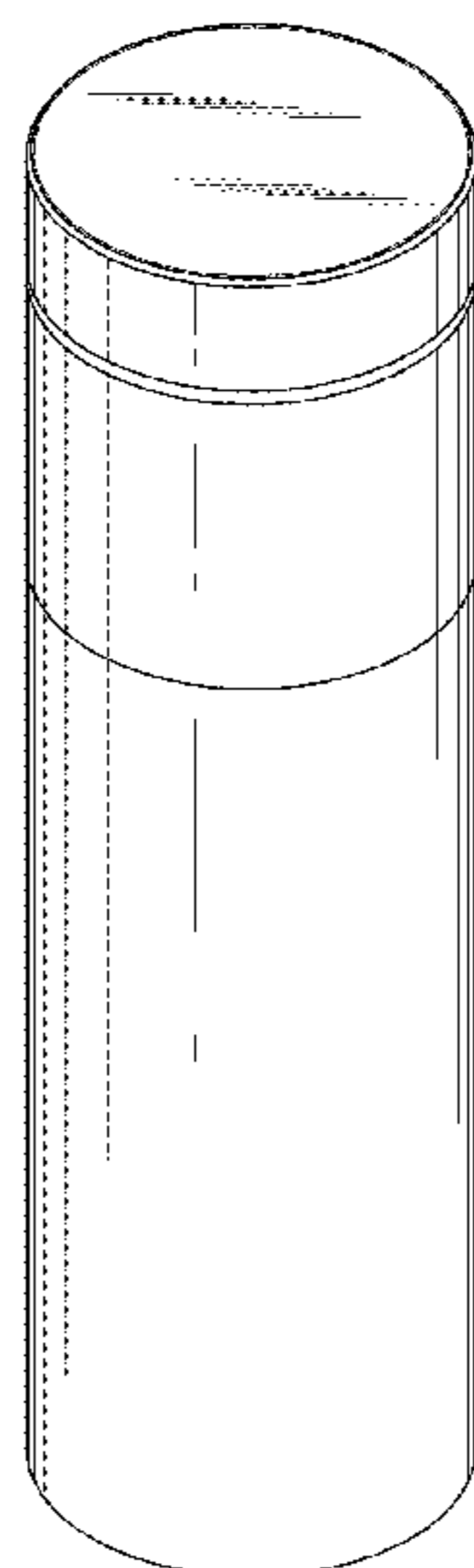

(58) **Field of Classification Search**  
 CPC ..... A45D 34/06; A45D 34/041; A45D 40/02;  
 A45D 40/06; A45D 40/18; A45D 40/262  
 See application file for complete search history.

(56) **References Cited**

U.S. PATENT DOCUMENTS

D368,328 S	3/1996	Wacker	
5,765,683 A *	6/1998	Starkle .....	A45D 40/18
			206/235
6,068,421 A *	5/2000	Pierpont .....	A45C 13/008
			220/796
D436,225 S *	1/2001	Garofano .....	D28/7
D471,324 S	3/2003	Kalin	
D496,496 S	9/2004	Ditrichstein	
D501,279 S	1/2005	Dittmer	
D567,447 S	4/2008	Lee	
7,883,287 B2	2/2011	Thorpe	
8,292,535 B2	10/2012	Thorpe	
8,464,731 B1	6/2013	Eberlein et al.	
8,556,527 B1	10/2013	Chou	
D694,622 S	12/2013	Bulens	
D703,384 S *	4/2014	DeMarco .....	D28/88
9,016,968 B2	4/2015	Thorpe	
D734,550 S	7/2015	Schlatter	
D744,166 S	11/2015	Chertoff	
9,538,824 B2	1/2017	Villarreal et al.	
9,578,949 B2	2/2017	Villarreal et al.	

9,833,055 B2	12/2017	Thorpe	
D808,280 S	1/2018	Nagata	
10,058,160 B2	8/2018	Chen	
D853,035 S	7/2019	Moretti	
D854,744 S *	7/2019	Tanaka .....	D28/7
D856,588 S	8/2019	French-Artis	
D904,691 S *	12/2020	Wolfe .....	D28/85
2011/0210039 A1 *	9/2011	Alongi .....	B65D 25/525
			206/581
2012/0266910 A1	10/2012	Tarling et al.	
2013/0051894 A1	2/2013	Lim et al.	
2013/0121745 A1	5/2013	Tarling et al.	
2014/0219701 A1	8/2014	Eberlein	
2014/0234004 A1	8/2014	Thorpe et al.	
2014/0376985 A1	12/2014	Villarreal et al.	
2015/0320179 A1 *	11/2015	Chevalier .....	A45D 40/267
			132/200
2017/0088314 A1 *	3/2017	Jacob .....	B65D 39/0052
2018/0021795 A1	1/2018	Apodaca et al.	
2018/0084892 A1	3/2018	Thorpe	
2019/0239618 A1	8/2019	Wolfe	
2019/0263568 A1 *	8/2019	De Rosa .....	B05B 11/0032

OTHER PUBLICATIONS

Magnetic Concept Lipstick Case Designed by Raepak, published Aug. 15, 2017, retrieved on Jan. 23, 2020, retrieved from the Internet URL: <https://www.raepak.com/concept-lipstick-cases/>.

\* cited by examiner

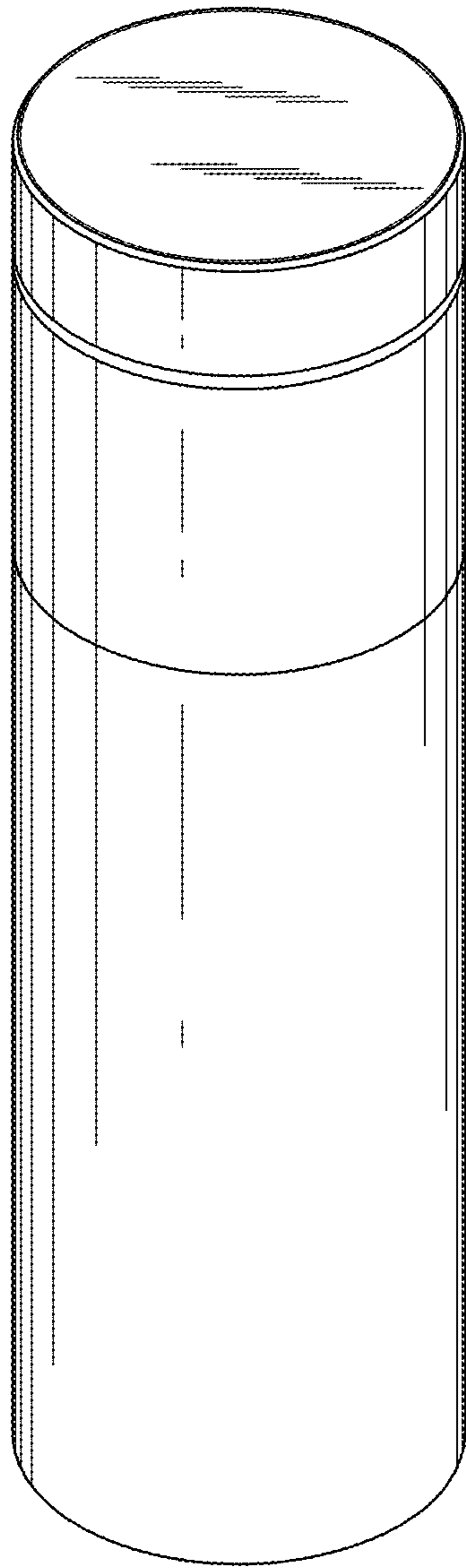

FIG. 1

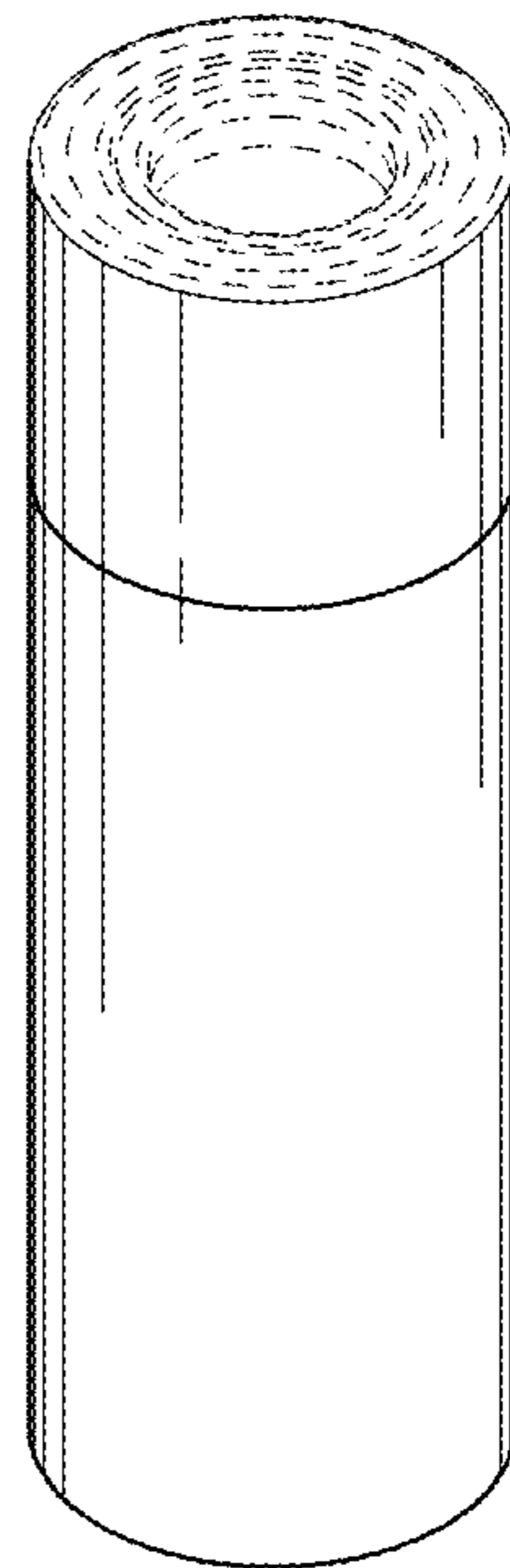
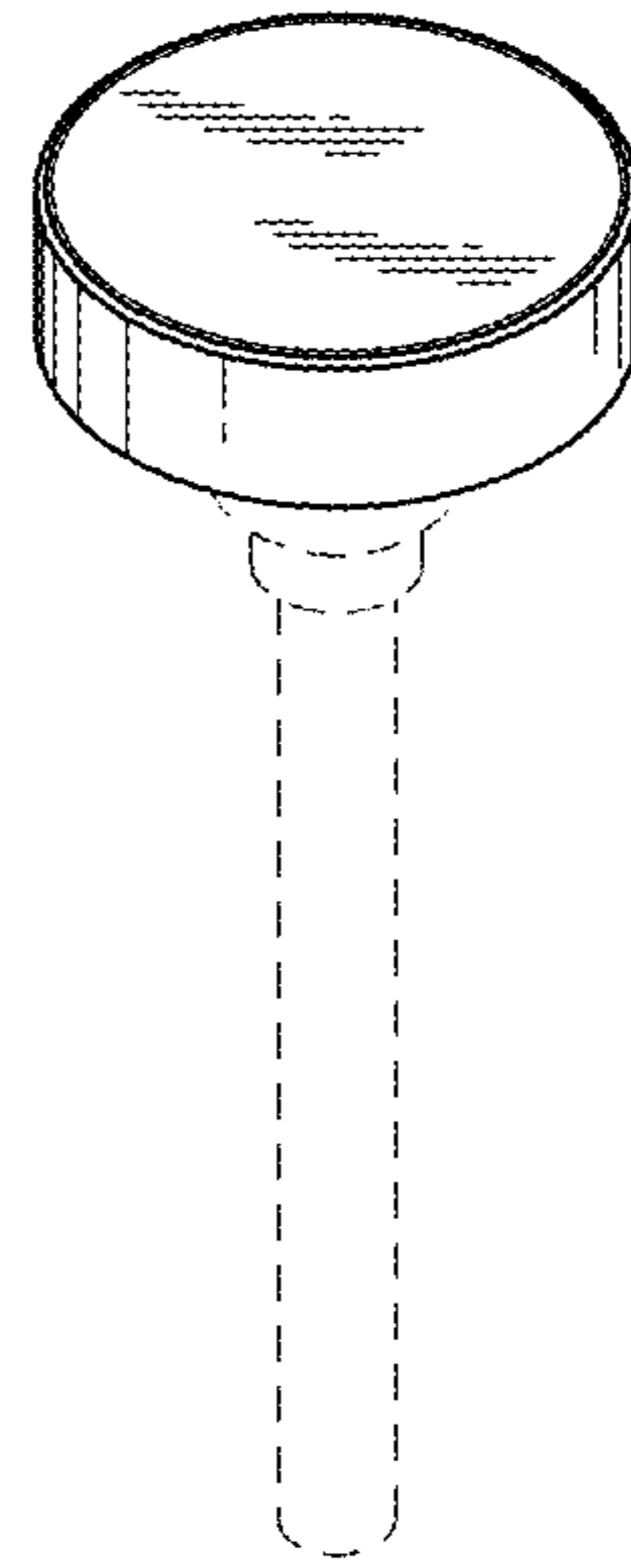

FIG. 2

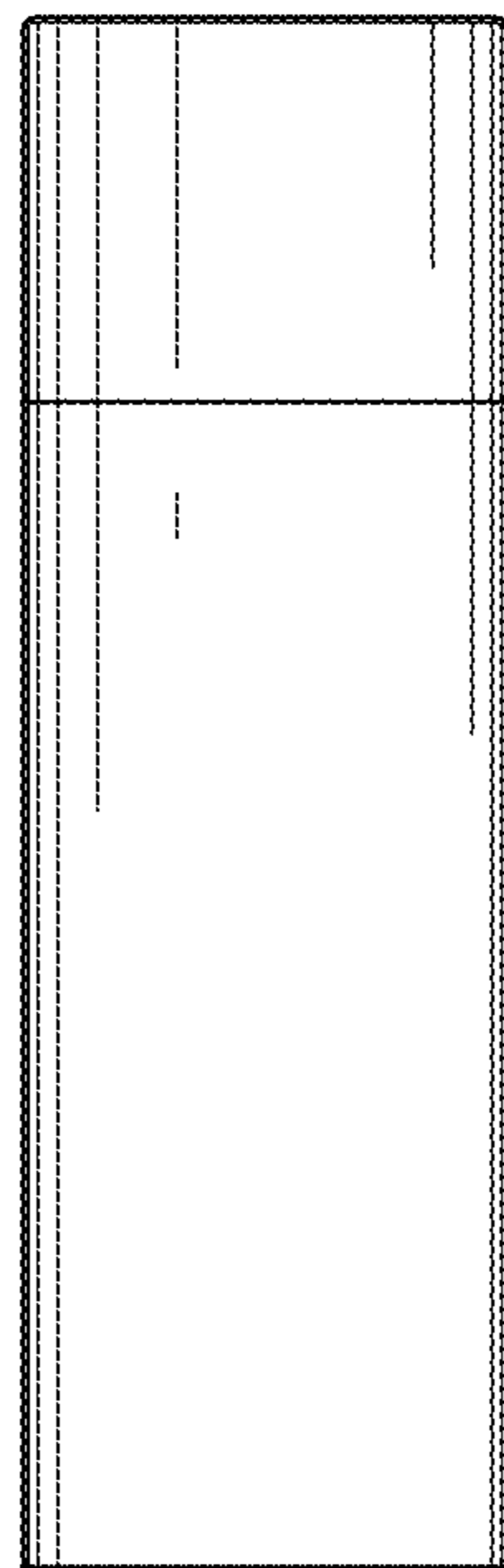
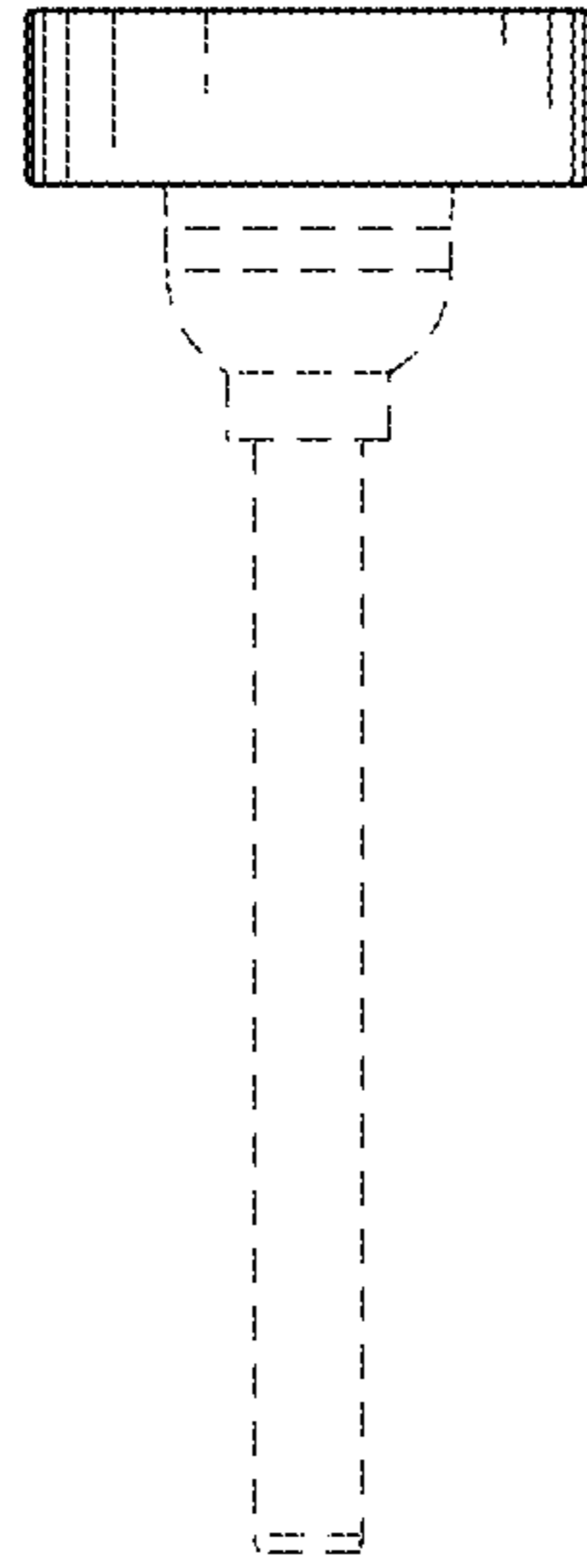

FIG. 3

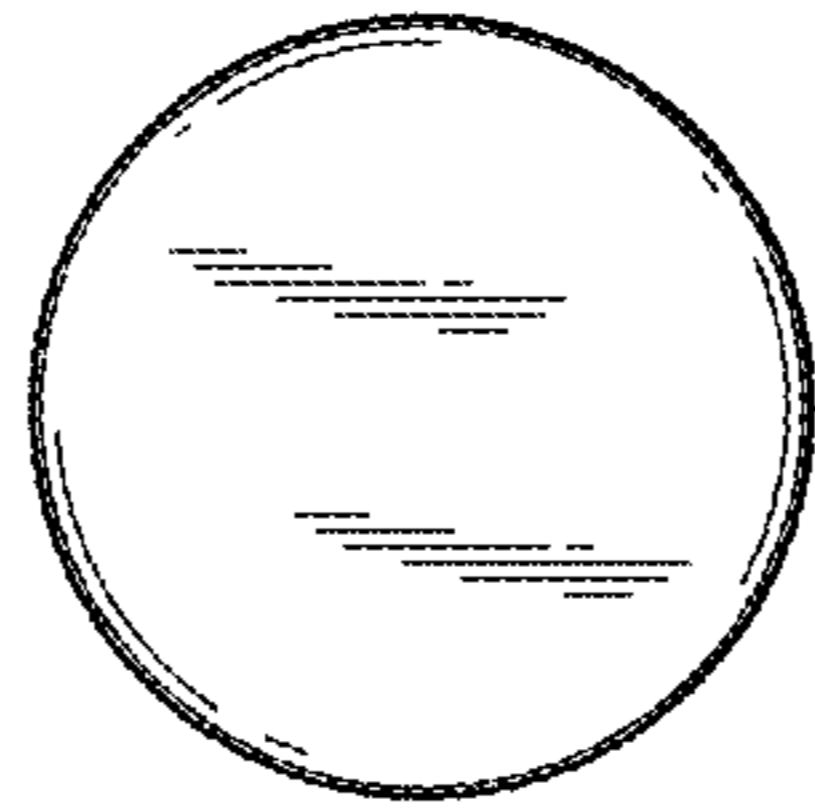

FIG. 4

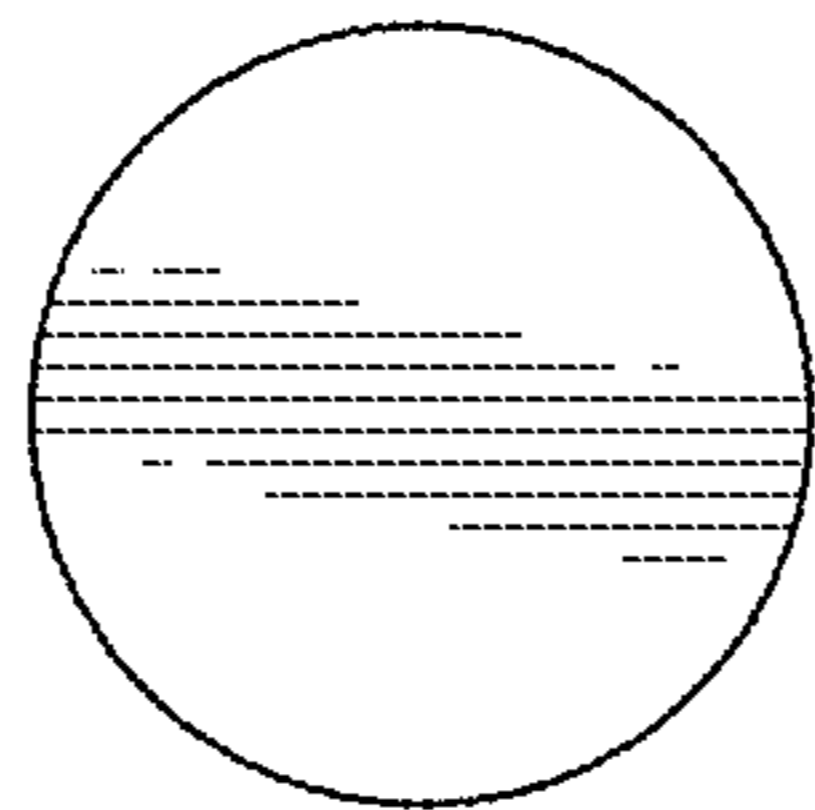

FIG. 5