



US00D926266S

(12) **United States Design Patent**
Ribbens et al.

(10) **Patent No.:** **US D926,266 S**

(45) **Date of Patent:** **** Jul. 27, 2021**

- (54) **FARM ANIMAL TOY SET**
- (71) Applicant: **SMART N.V.**, Kontich (BE)
- (72) Inventors: **Emma Ribbens**, Antwerp (BE); **Tom Buelens**, Borgerhout (BE)
- (73) Assignee: **Smart N.V.**, Kontich (BE)
- (**) Term: **15 Years**
- (21) Appl. No.: **29/699,907**
- (22) Filed: **Jul. 30, 2019**
- (51) **LOC (13) Cl.** **21-01**
- (52) **U.S. Cl.**
USPC **D21/590**
- (58) **Field of Classification Search**
USPC D6/598; D11/158–159, 162;
D21/576–596, 609, 610, 620, 652, 654;
180/8.6; D30/160
CPC ... A63H 3/00; A63H 3/02; A63H 3/04; A63H
3/16; A63H 3/28; A63H 3/36; A63H
7/06; A63H 11/00; A63H 11/10; A63H
11/20; A63H 11/205; A63H 13/00; A63H
13/02; A63H 33/04; A63H 33/08; A63H
33/042; A63H 23/10; A63H 5/00
See application file for complete search history.

- D781,968 S * 3/2017 Cummings D21/620
- D781,970 S * 3/2017 Cummings D21/654
- D782,584 S * 3/2017 Cummings D21/610
- D848,548 S * 5/2019 Cummings D21/610
- D848,552 S * 5/2019 Cummings D21/620

OTHER PUBLICATIONS

TTPM Toy Reviews, SmartMax My First Farm Animals, published on YouTube on Dec. 7, 2018. <https://www.youtube.com/watch?v=fDigldAFk8A>.*

U.S. Toy Co. Inc 1993 Party Catalog. p. 77, "Large Farm Animals".*

* cited by examiner

Primary Examiner — Jennifer L Rempfer

(74) *Attorney, Agent, or Firm* — Hodgson Russ LLP

(57) **CLAIM**

The ornamental design for a farm animal toy set, as shown and described.

DESCRIPTION

FIG. 1 is a perspective view of a farm animal toy set;
 FIG. 2 is a perspective view of a first portion of a first piece thereof;
 FIG. 3 is a front elevation view thereof;
 FIG. 4 is a rear elevation view thereof;
 FIG. 5 is a right side elevation view thereof;
 FIG. 6 is a left side elevation view thereof;
 FIG. 7 is a bottom plan view thereof;
 FIG. 8 is a top plan view thereof;
 FIG. 9 is a perspective view of a second portion of the first piece;
 FIG. 10 is a front elevation view thereof;
 FIG. 11 is a rear elevation view thereof;
 FIG. 12 is a right side elevation view thereof;
 FIG. 13 is a left side elevation view thereof;
 FIG. 14 is a bottom plan view thereof;
 FIG. 15 is a top plan view thereof;
 FIG. 16 is a perspective view of a second piece of the farm animal toy set;

(56) **References Cited**

U.S. PATENT DOCUMENTS

- D128,134 S * 7/1941 Bendersky D21/595
- D142,302 S * 8/1945 Laskey D21/590
- D155,086 S * 9/1949 Goldfarb D21/609
- D194,911 S * 4/1963 Markham D21/652
- D194,918 S * 4/1963 Markham D21/609
- D281,519 S * 11/1985 Pedersen D21/620
- D295,774 S * 5/1988 Zinter-Chahin D11/162
- D384,999 S * 10/1997 Stephensen D21/610
- D385,594 S * 10/1997 Stephensen D21/652
- D385,599 S * 10/1997 Stephensen D21/654
- D532,463 S * 11/2006 Boutin A47D 13/086
D21/609
- D689,963 S * 9/2013 Thorsen D21/620
- D704,777 S * 5/2014 Nguyen D21/590

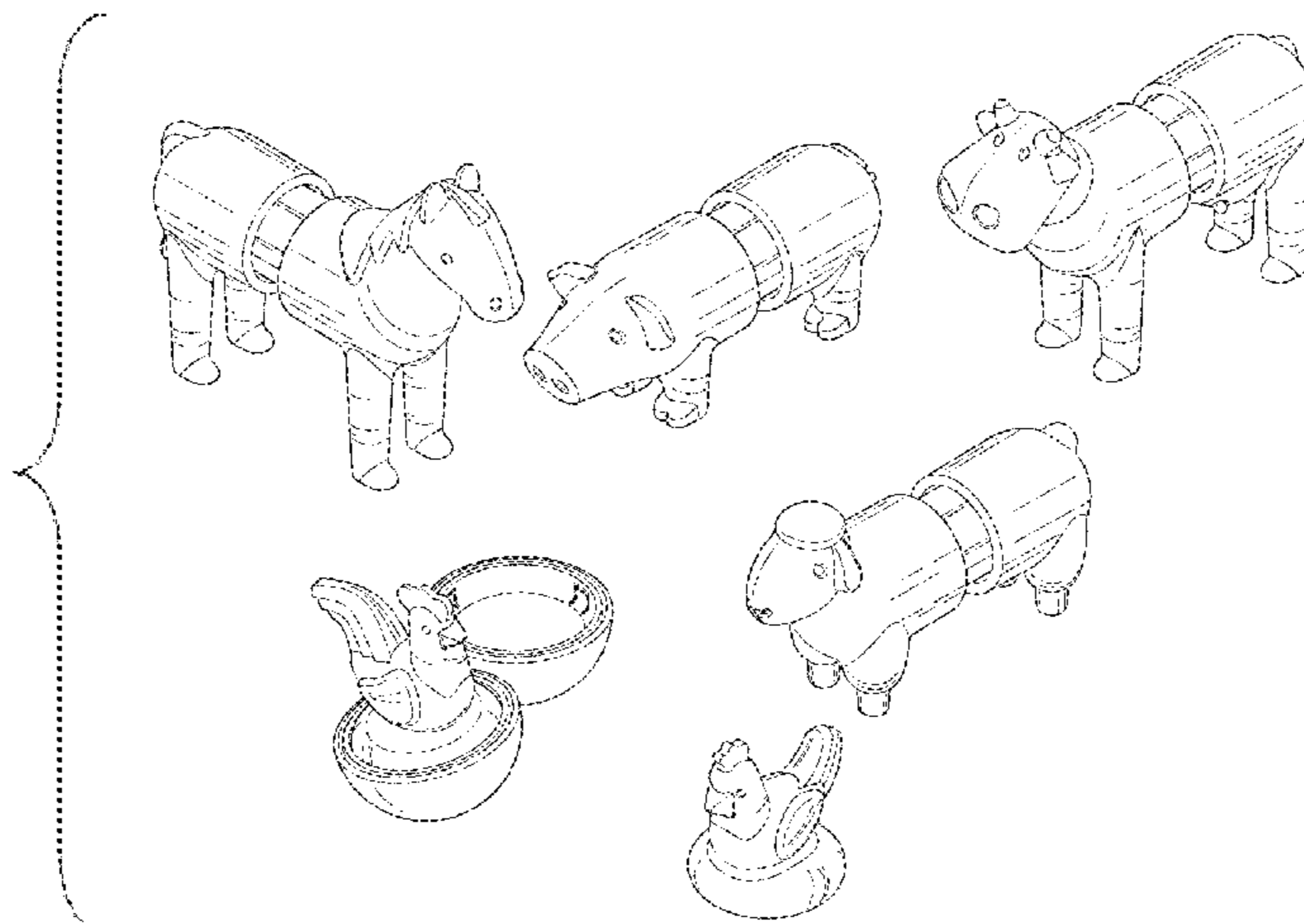

FIG. 17 is a perspective view of a first portion of the second piece, shown broken away for ease of illustration;
 FIG. 18 is a front elevation view thereof;
 FIG. 19 is a rear elevation view thereof;
 FIG. 20 is a right side elevation view thereof;
 FIG. 21 is a left side elevation view thereof;
 FIG. 22 is a bottom plan view thereof;
 FIG. 23 is a top plan view thereof;
 FIG. 24 is a perspective view of a second portion of the second piece;
 FIG. 25 is a front elevation view thereof;
 FIG. 26 is a rear elevation view thereof;
 FIG. 27 is a right side elevation view thereof;
 FIG. 28 is a left side elevation view thereof;
 FIG. 29 is a bottom plan view thereof;
 FIG. 30 is a top plan view thereof;
 FIG. 31 is a perspective view of a third piece of the farm animal toy set;
 FIG. 32 is a perspective view of a first portion of the third piece, shown broken away for ease of illustration;
 FIG. 33 is a front elevation view thereof;
 FIG. 34 is a rear elevation view thereof;
 FIG. 35 is a right side elevation view thereof;
 FIG. 36 is a left side elevation view thereof;
 FIG. 37 is a bottom plan view thereof;
 FIG. 38 is a top plan view thereof;
 FIG. 39 is a perspective view of a second portion of the third piece;
 FIG. 40 is a front elevation view thereof;
 FIG. 41 is a rear elevation view thereof;
 FIG. 42 is a right side elevation view thereof;
 FIG. 43 is a left side elevation view thereof;
 FIG. 44 is a bottom plan view thereof;
 FIG. 45 is a top plan view thereof;
 FIG. 46 is a perspective view of a third portion of the third piece;
 FIG. 47 is a front elevation view thereof;
 FIG. 48 is a rear elevation view thereof;
 FIG. 49 is a right side elevation view thereof;
 FIG. 50 is a left side elevation view thereof;
 FIG. 51 is a bottom plan view thereof;
 FIG. 52 is a top plan view thereof;
 FIG. 53 is a perspective view of a fourth piece of the farm animal toy set;
 FIG. 54 is a perspective view of a first portion of the fourth piece, shown broken away for ease of illustration;
 FIG. 55 is a front elevation view thereof;
 FIG. 56 is a rear elevation view thereof;
 FIG. 57 is a right side elevation view thereof;
 FIG. 58 is a left side elevation view thereof;
 FIG. 59 is a bottom plan view thereof;
 FIG. 60 is a top plan view thereof;
 FIG. 61 is a perspective view of a second portion of the fourth piece;
 FIG. 62 is a front elevation view thereof;
 FIG. 63 is a rear elevation view thereof;
 FIG. 64 is a right side elevation view thereof;
 FIG. 65 is a left side elevation view thereof;
 FIG. 66 is a bottom plan view thereof;
 FIG. 67 is a top plan view thereof;

FIG. 68 is a perspective view of a third portion of the fourth piece;
 FIG. 69 is a front elevation view thereof;
 FIG. 70 is a rear elevation view thereof;
 FIG. 71 is a right side elevation view thereof;
 FIG. 72 is a left side elevation view thereof;
 FIG. 73 is a bottom plan view thereof;
 FIG. 74 is a top plan view thereof;
 FIG. 75 is a perspective view of a fifth piece of the farm animal toy set;
 FIG. 76 is a perspective view of a first portion of the fifth piece, shown broken away for ease of illustration;
 FIG. 77 is a front elevation view thereof;
 FIG. 78 is a rear elevation view thereof;
 FIG. 79 is a right side elevation view thereof;
 FIG. 80 is a left side elevation view thereof;
 FIG. 81 is a bottom plan view thereof;
 FIG. 82 is a top plan view thereof;
 FIG. 83 is a perspective view of a second portion of the fifth piece;
 FIG. 84 is a front elevation view thereof;
 FIG. 85 is a rear elevation view thereof;
 FIG. 86 is a right side elevation view thereof;
 FIG. 87 is a left side elevation view thereof;
 FIG. 88 is a bottom plan view thereof;
 FIG. 89 is a top plan view thereof;
 FIG. 90 is a perspective view of a third portion of the fifth piece;
 FIG. 91 is a front elevation view thereof;
 FIG. 92 is a rear elevation view thereof;
 FIG. 93 is a right side elevation view thereof;
 FIG. 94 is a left side elevation view thereof;
 FIG. 95 is a bottom plan view thereof;
 FIG. 96 is a top plan view thereof;
 FIG. 97 is a perspective view of a sixth piece of the farm animal toy set;
 FIG. 98 is a perspective view of a first portion of the sixth piece, shown broken away for ease of illustration;
 FIG. 99 is a front elevation view thereof;
 FIG. 100 is a rear elevation view thereof;
 FIG. 101 is a right side elevation view thereof;
 FIG. 102 is a left side elevation view thereof;
 FIG. 103 is a bottom plan view thereof;
 FIG. 104 is a top plan view thereof;
 FIG. 105 is a perspective view of a second portion of the sixth piece;
 FIG. 106 is a front elevation view thereof;
 FIG. 107 is a rear elevation view thereof;
 FIG. 108 is a right side elevation view thereof;
 FIG. 109 is a left side elevation view thereof;
 FIG. 110 is a bottom plan view thereof;
 FIG. 111 is a top plan view thereof; and
 FIG. 112 is a perspective view of a third portion of the sixth piece;
 FIG. 113 is a front elevation view thereof;
 FIG. 114 is a rear elevation view thereof;
 FIG. 115 is a right side elevation view thereof;
 FIG. 116 is a left side elevation view thereof;
 FIG. 117 is a bottom plan view thereof; and
 FIG. 118 is a top plan view thereof.

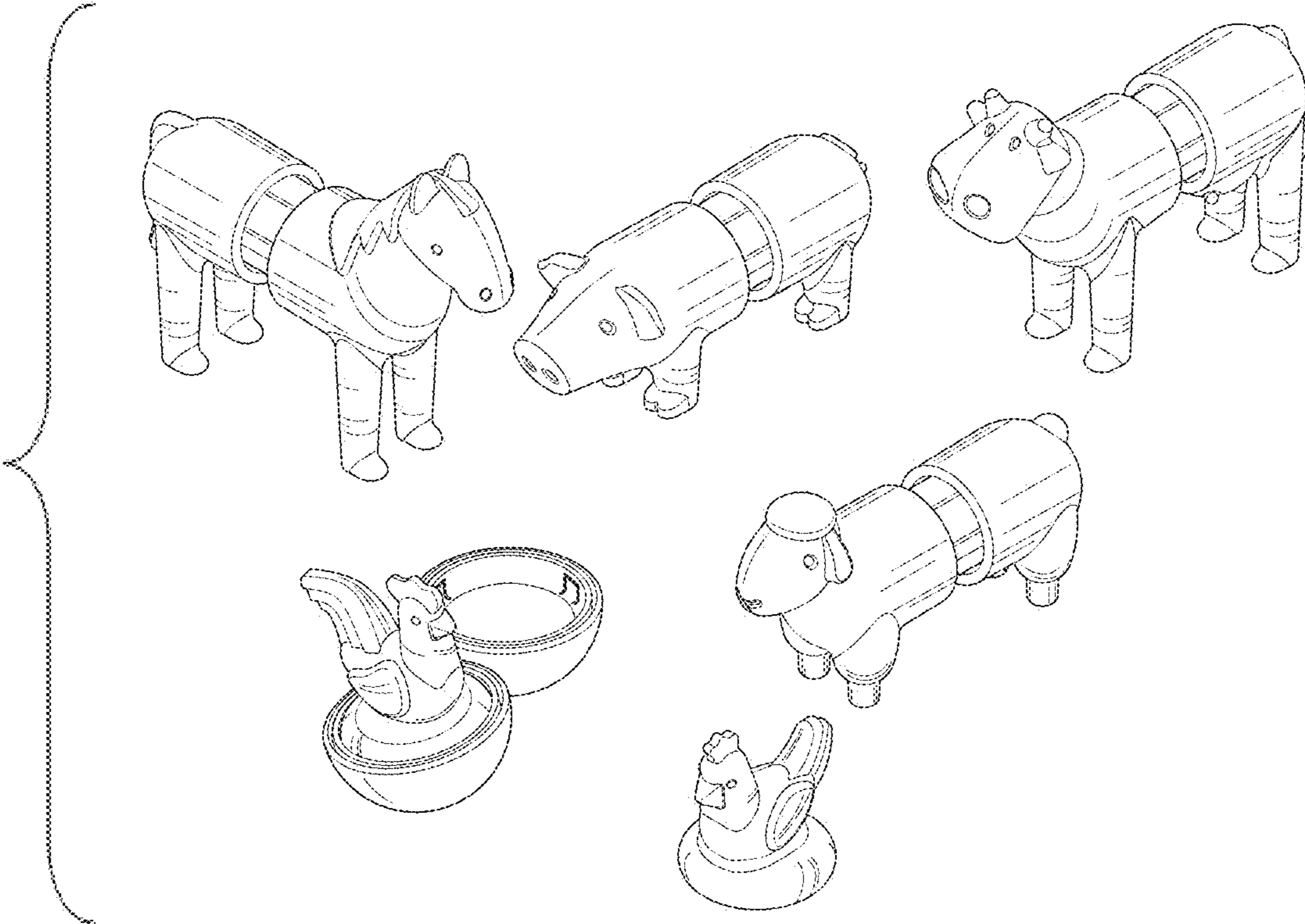

FIG. 1



FIG. 2

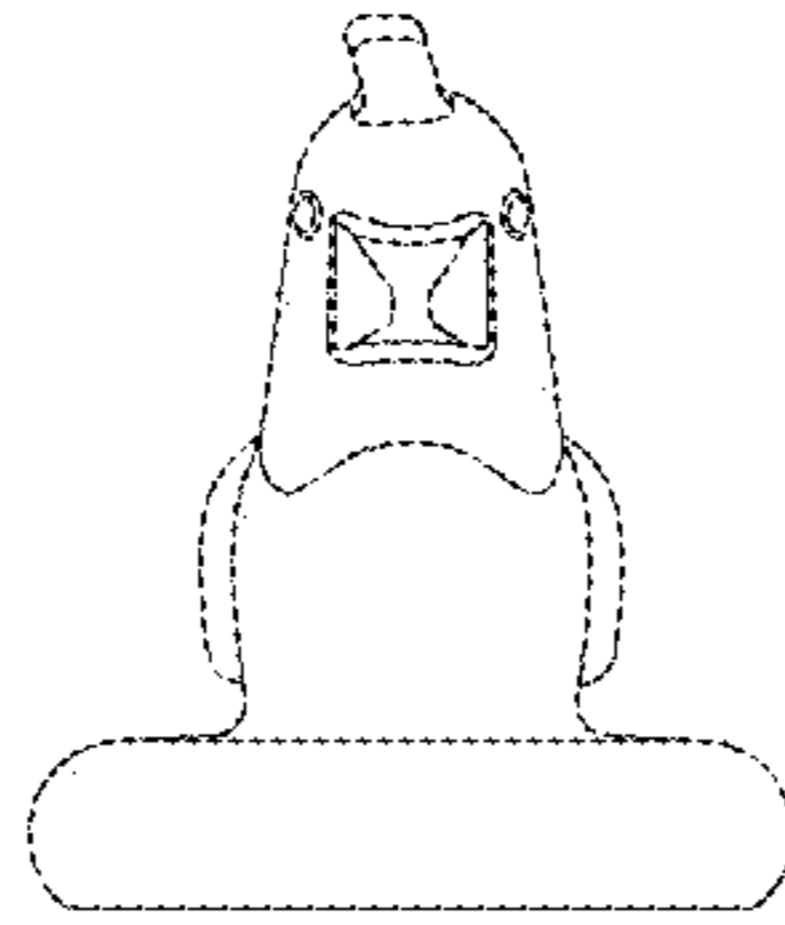

FIG. 3

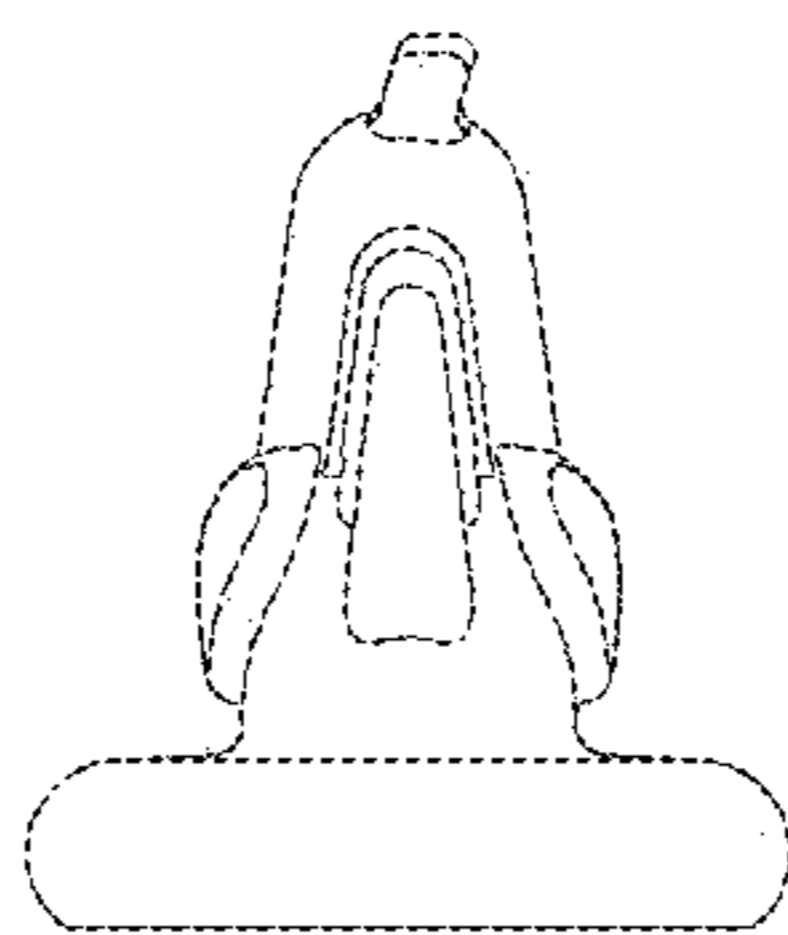

FIG. 4



FIG. 5

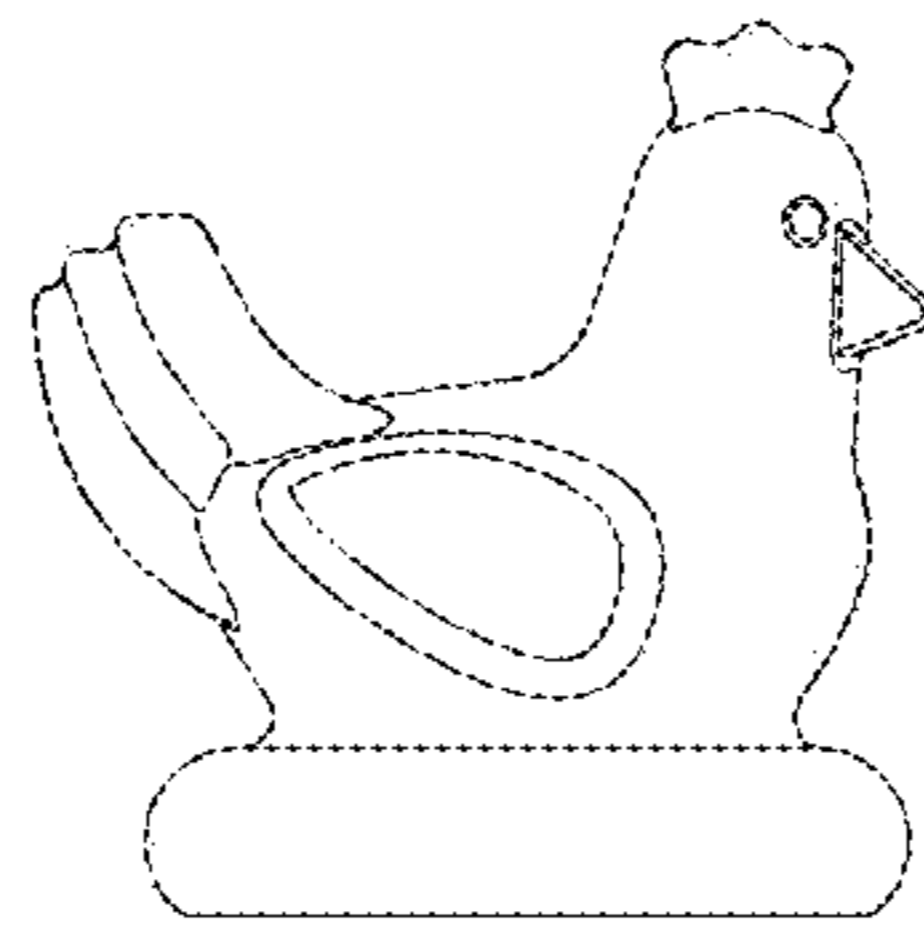

FIG. 6

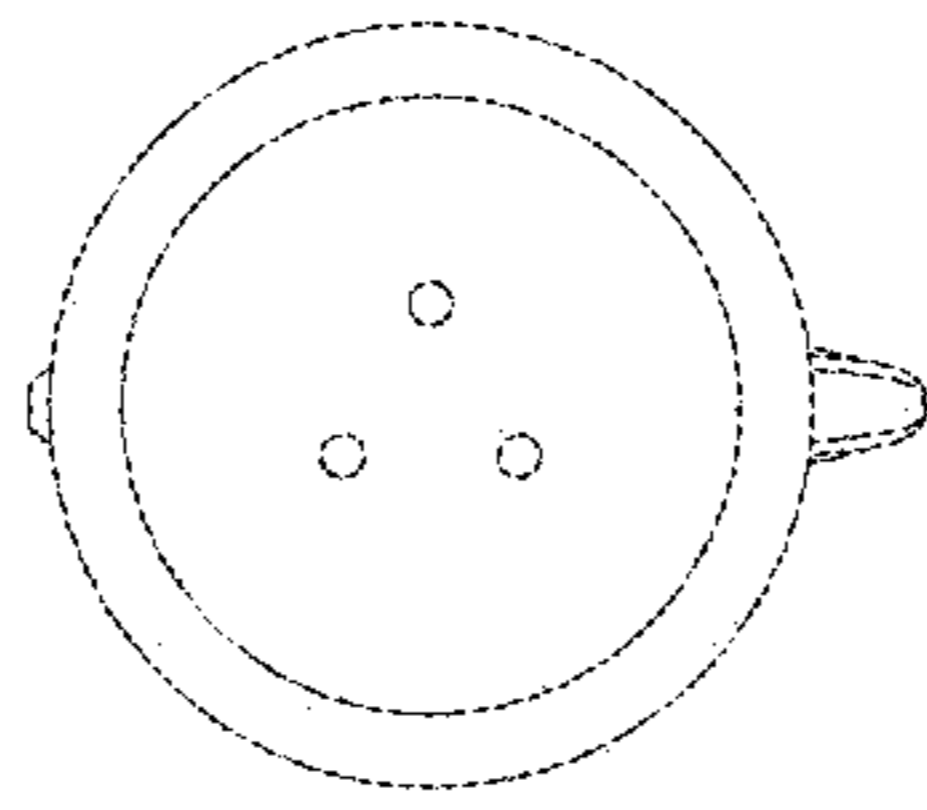

FIG. 7

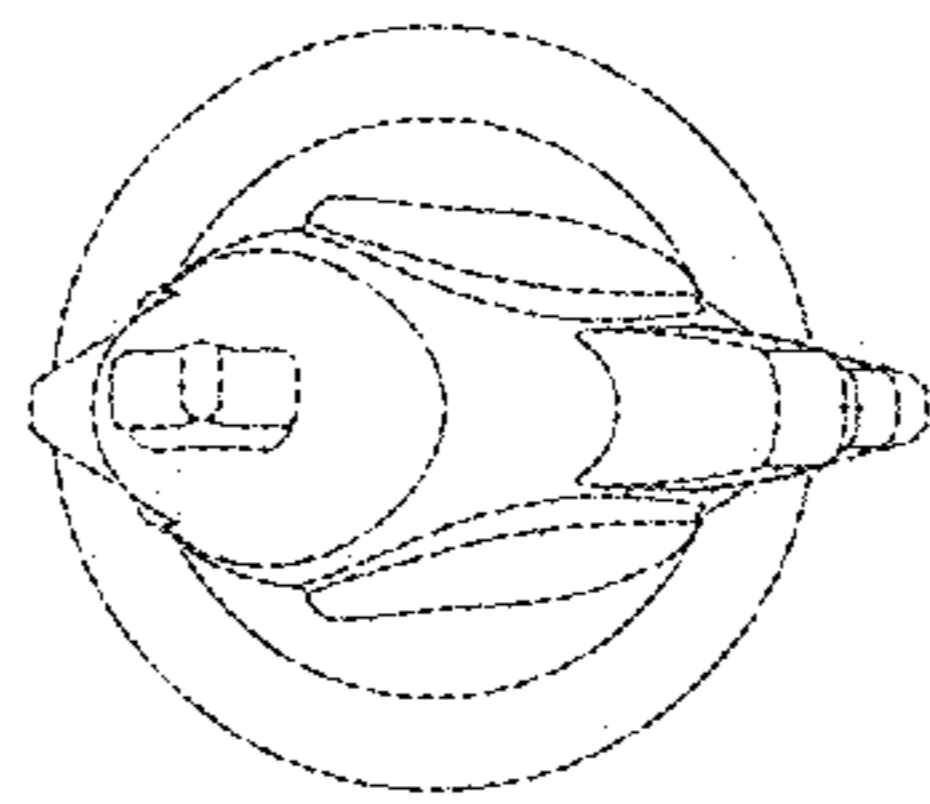

FIG. 8

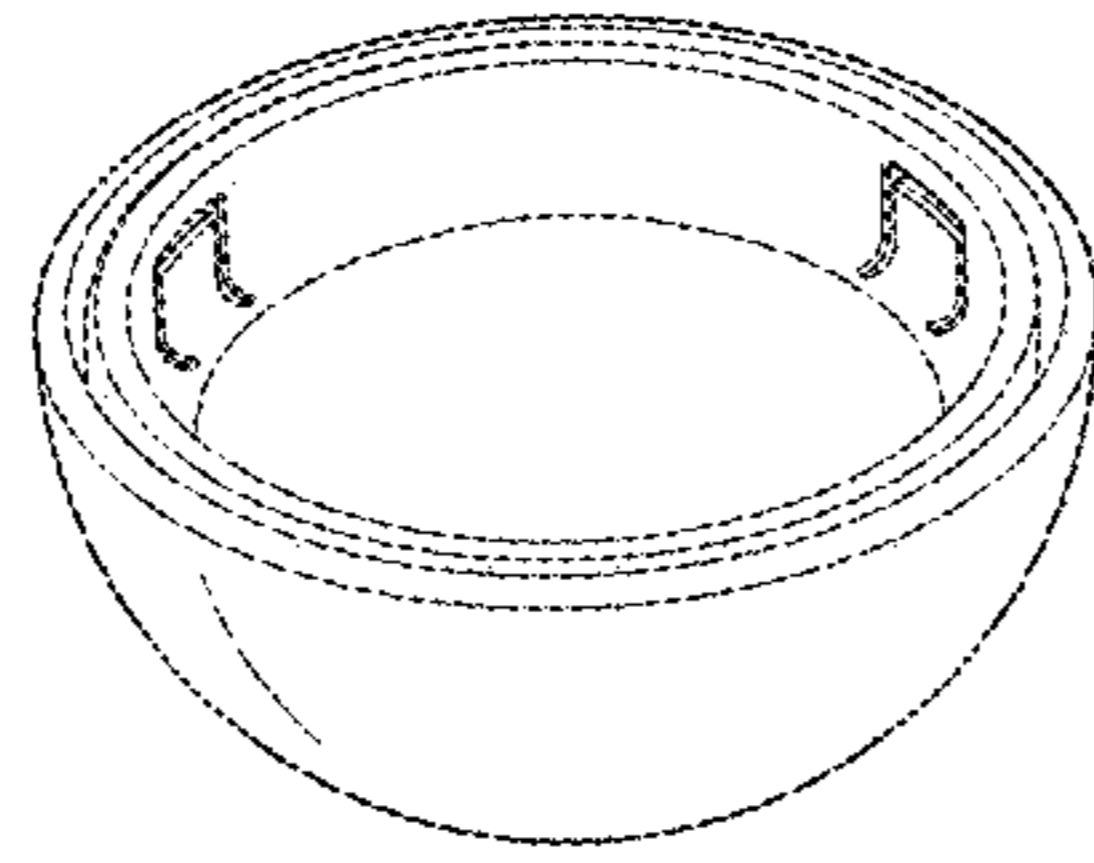

FIG. 9

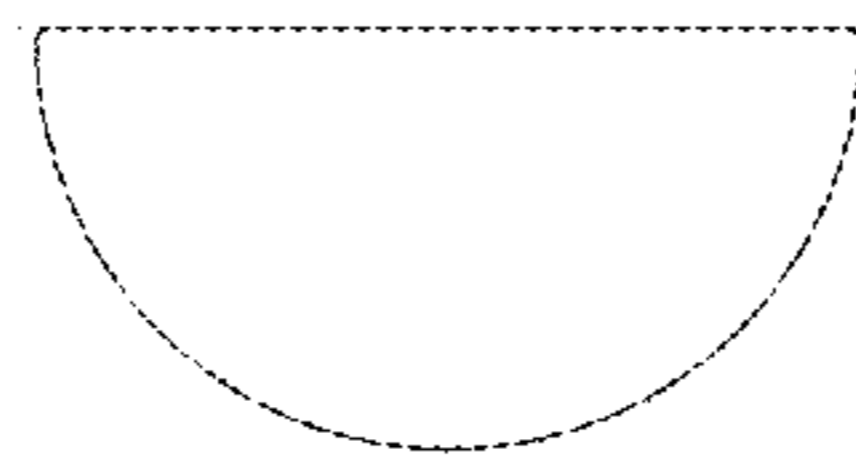

FIG. 10

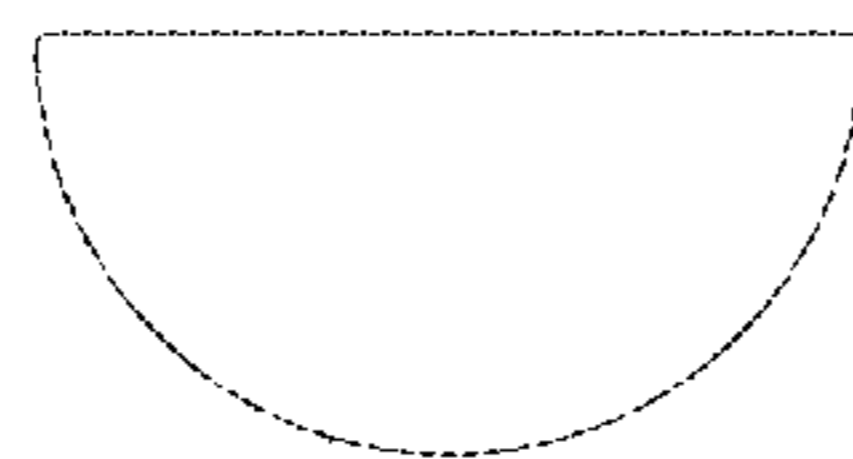

FIG. 11

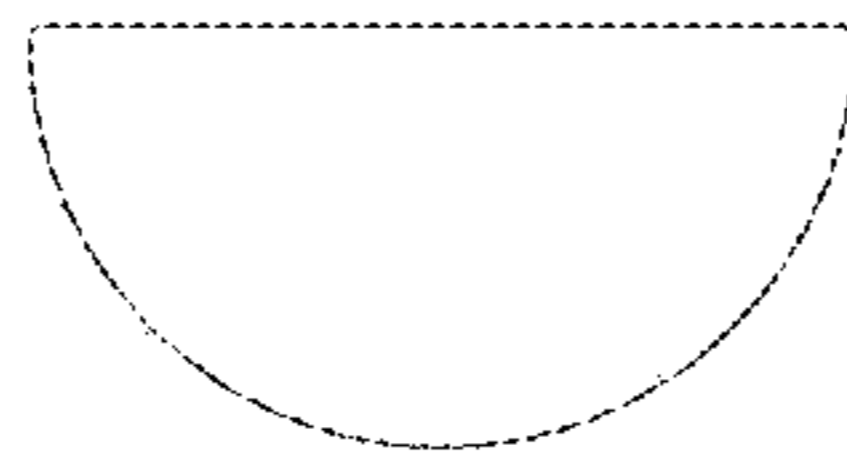

FIG. 12

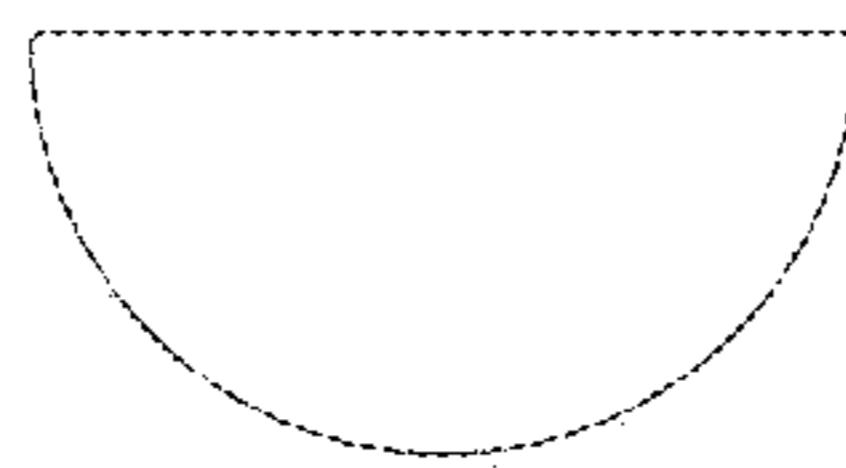

FIG. 13

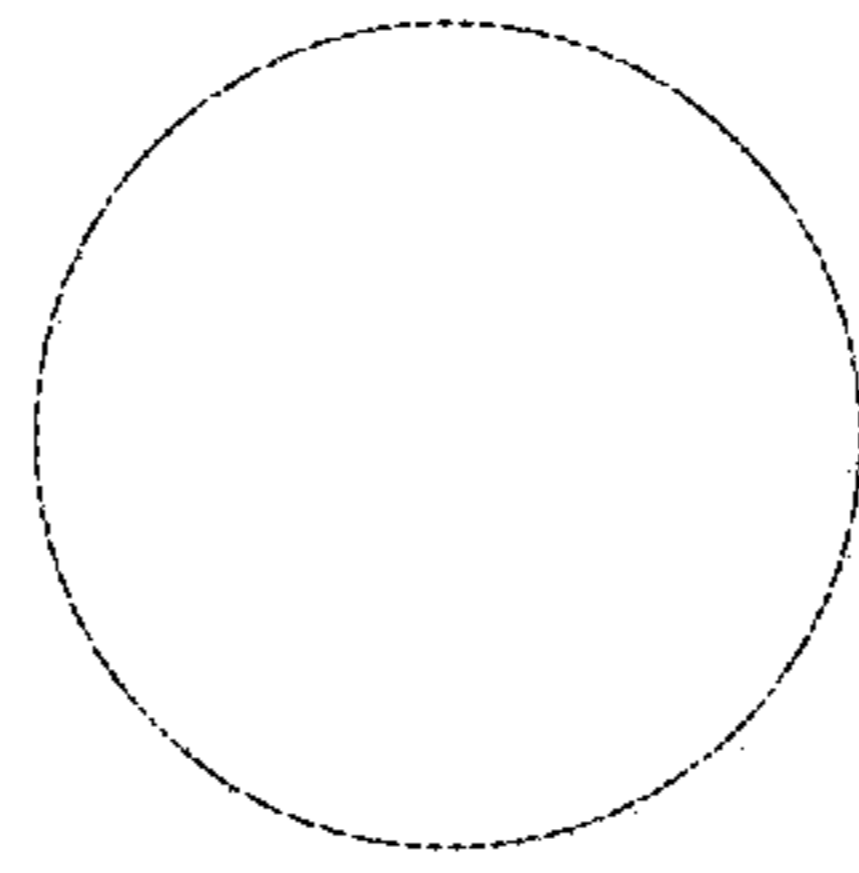

FIG. 14

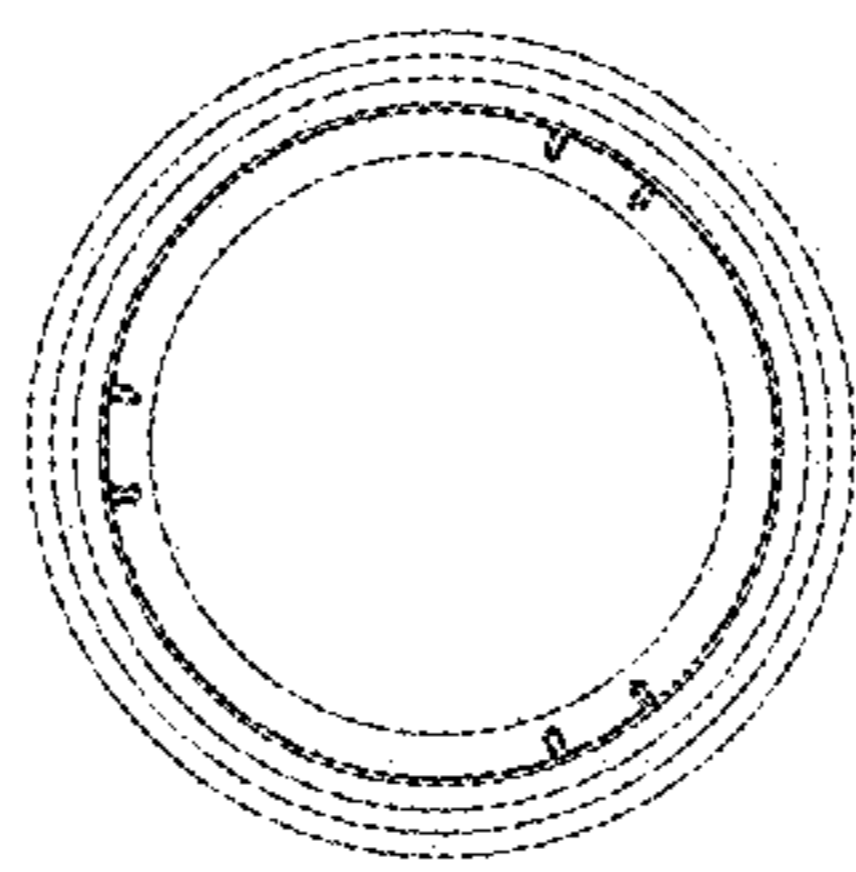

FIG. 15

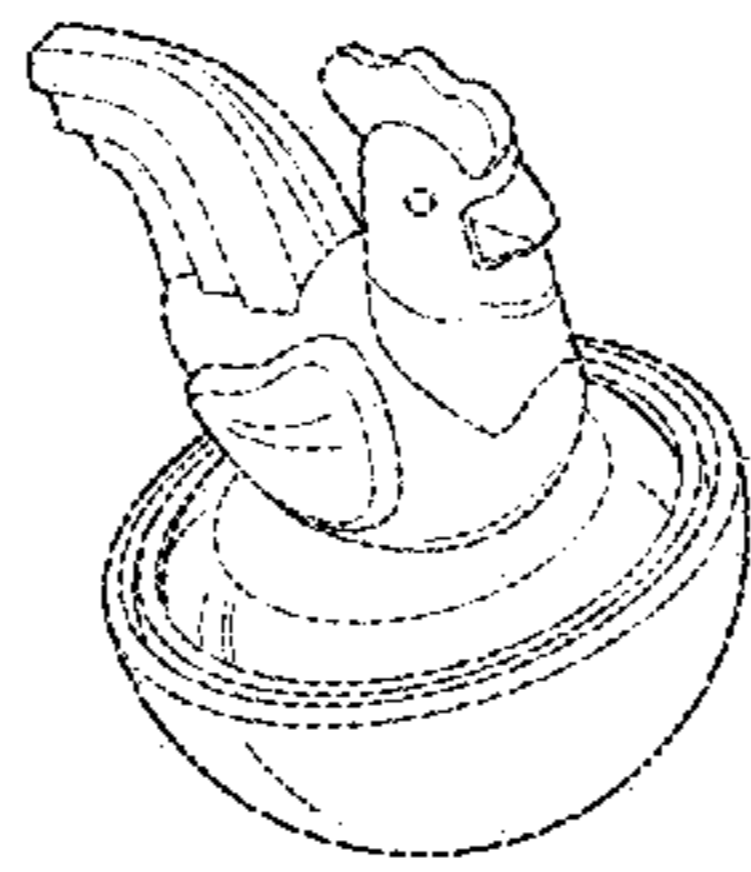

FIG. 16



FIG. 17

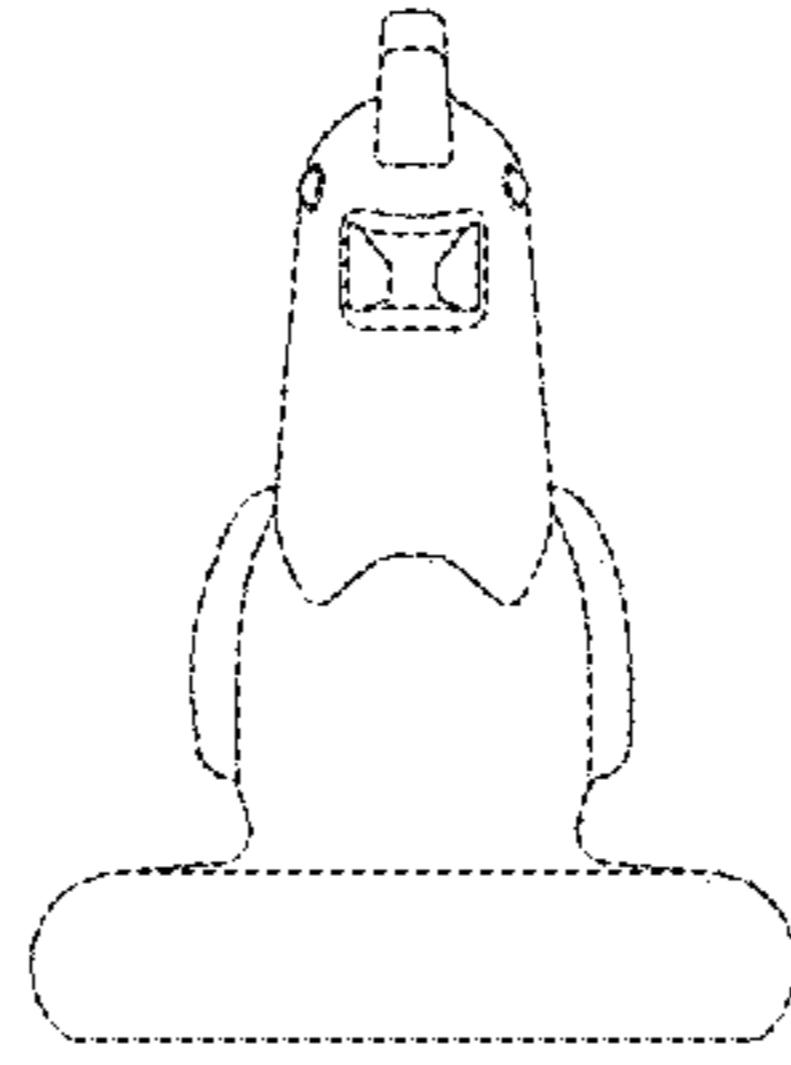

FIG. 18

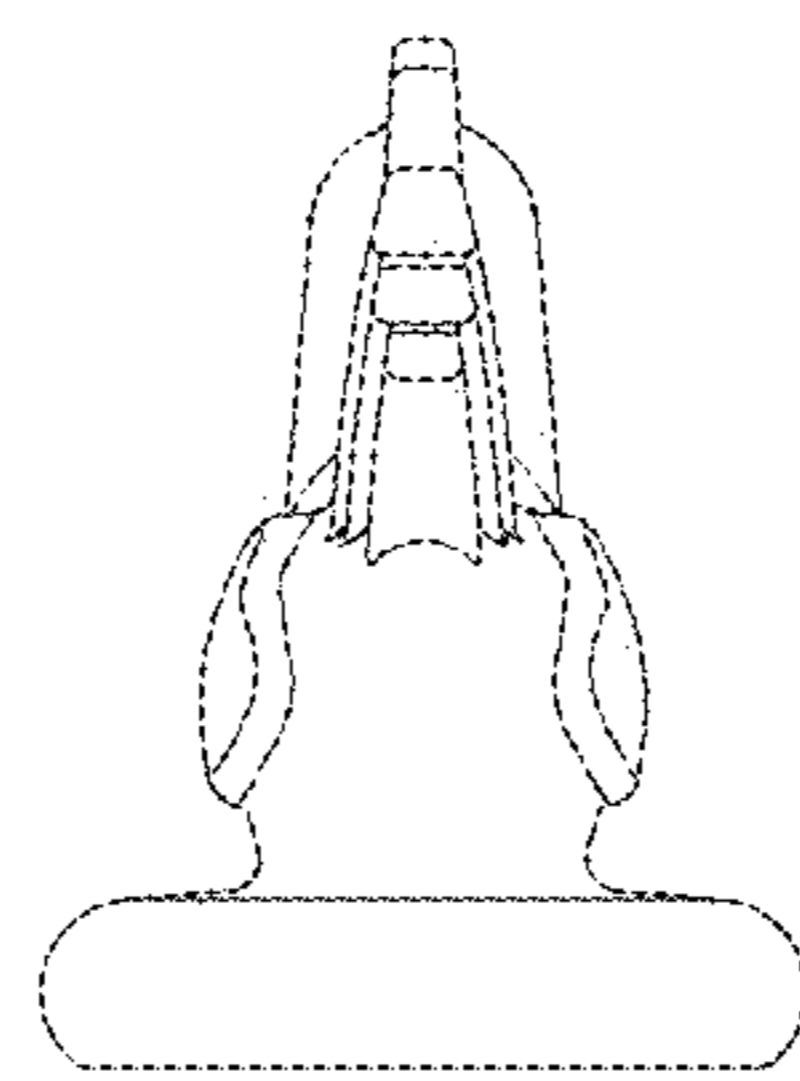

FIG. 19

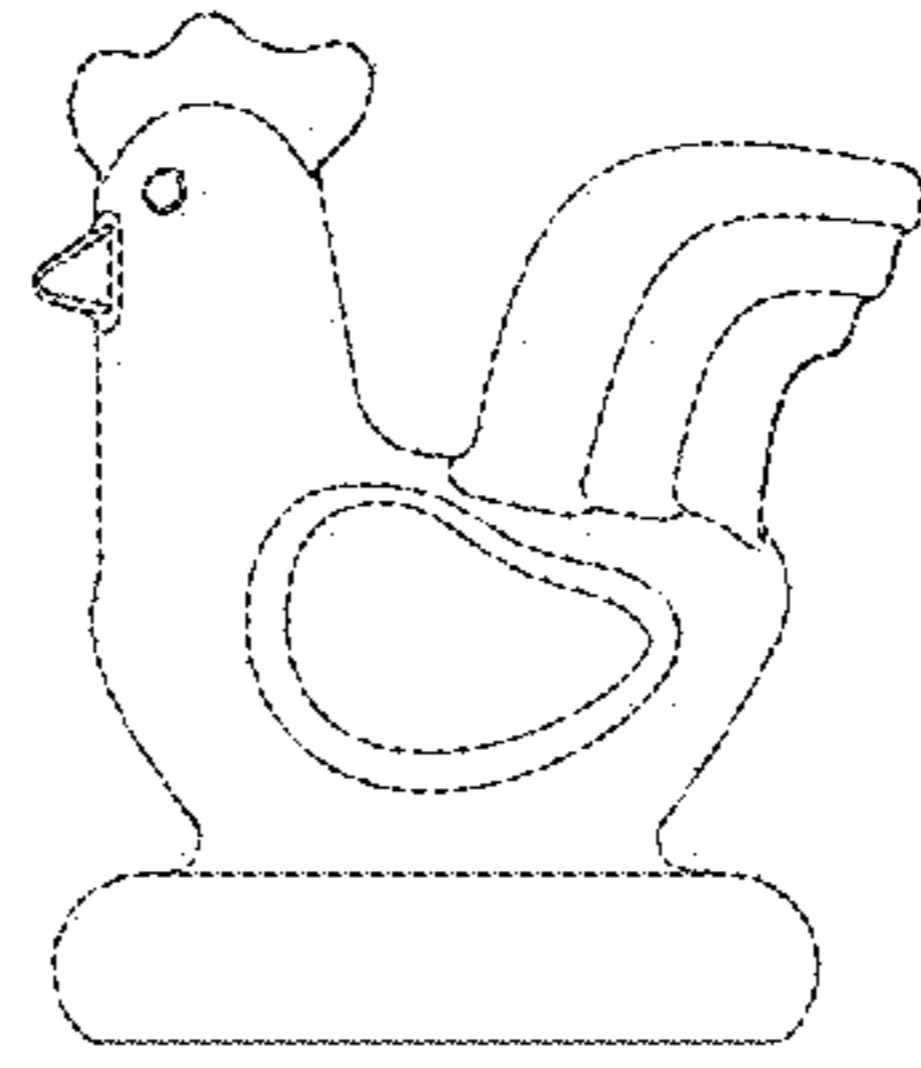

FIG. 20

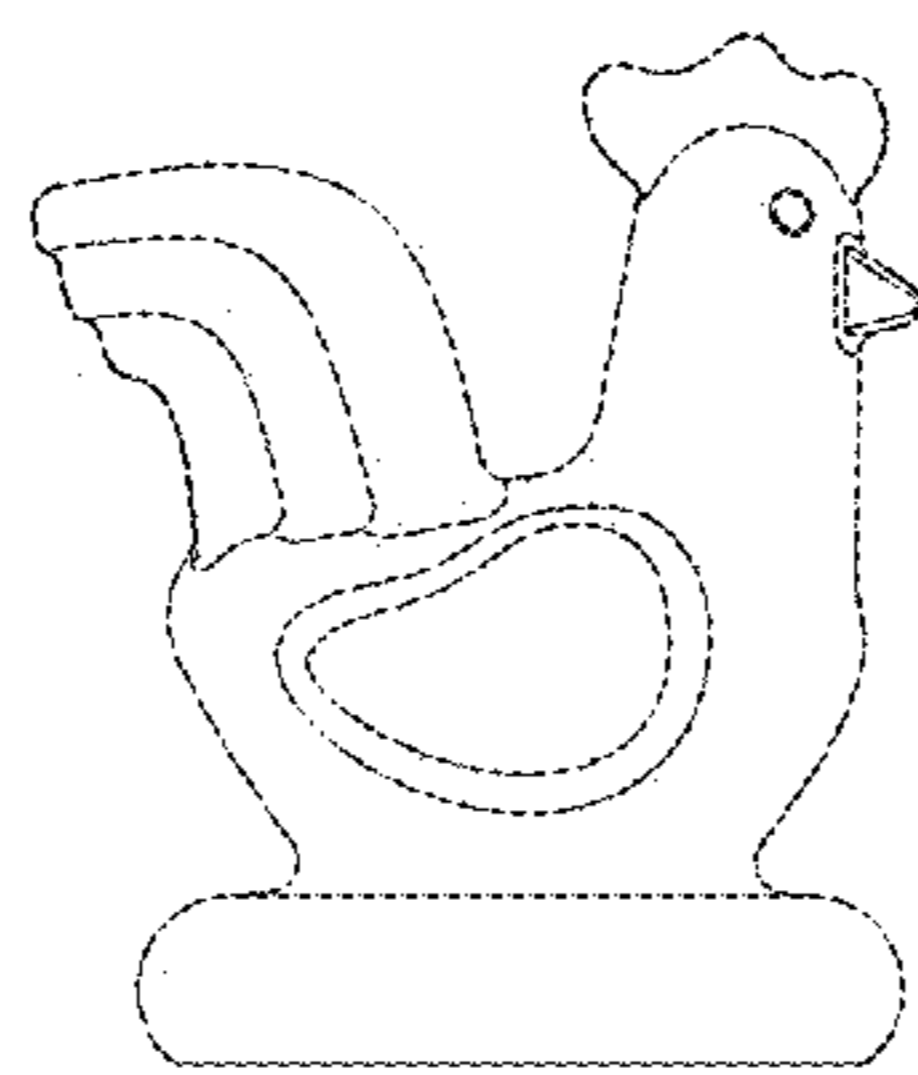

FIG. 21

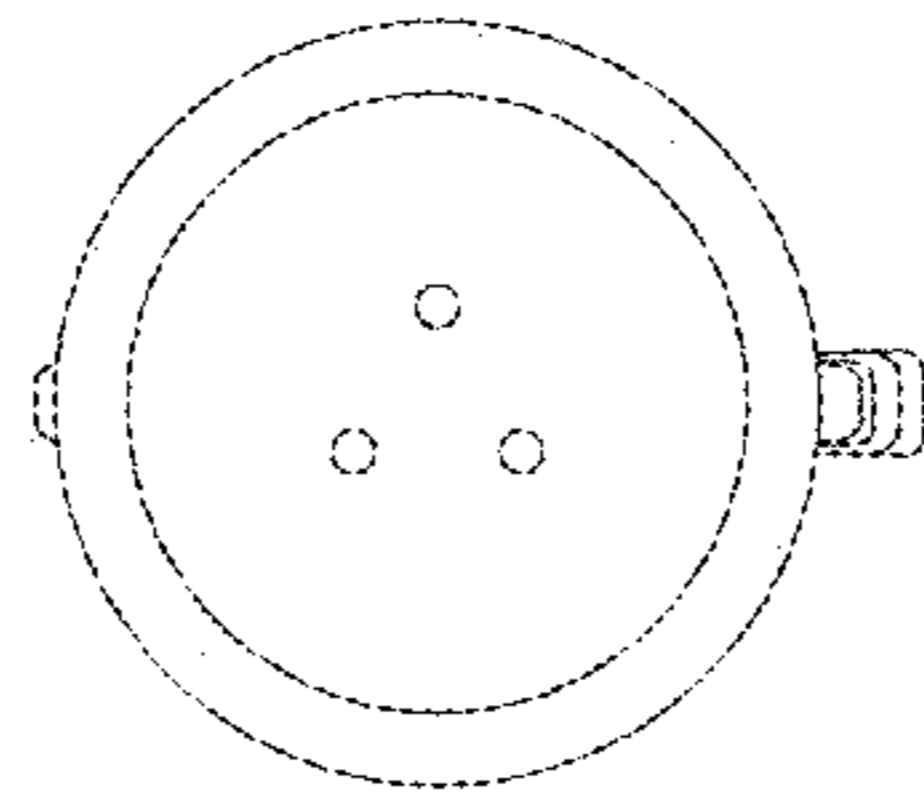

FIG. 22

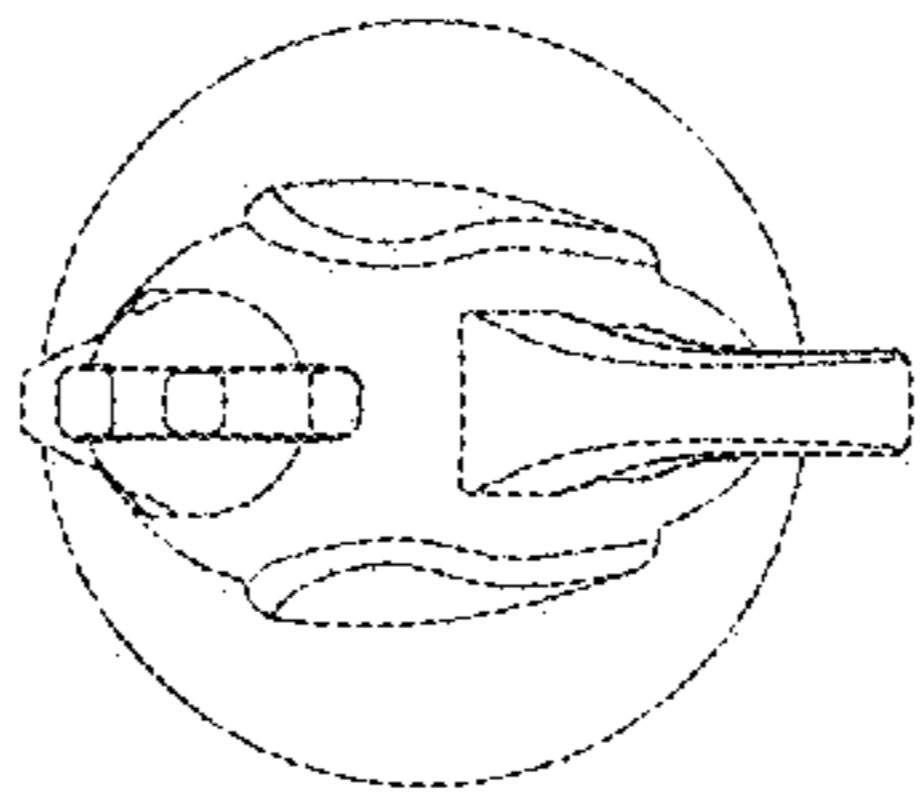

FIG. 23

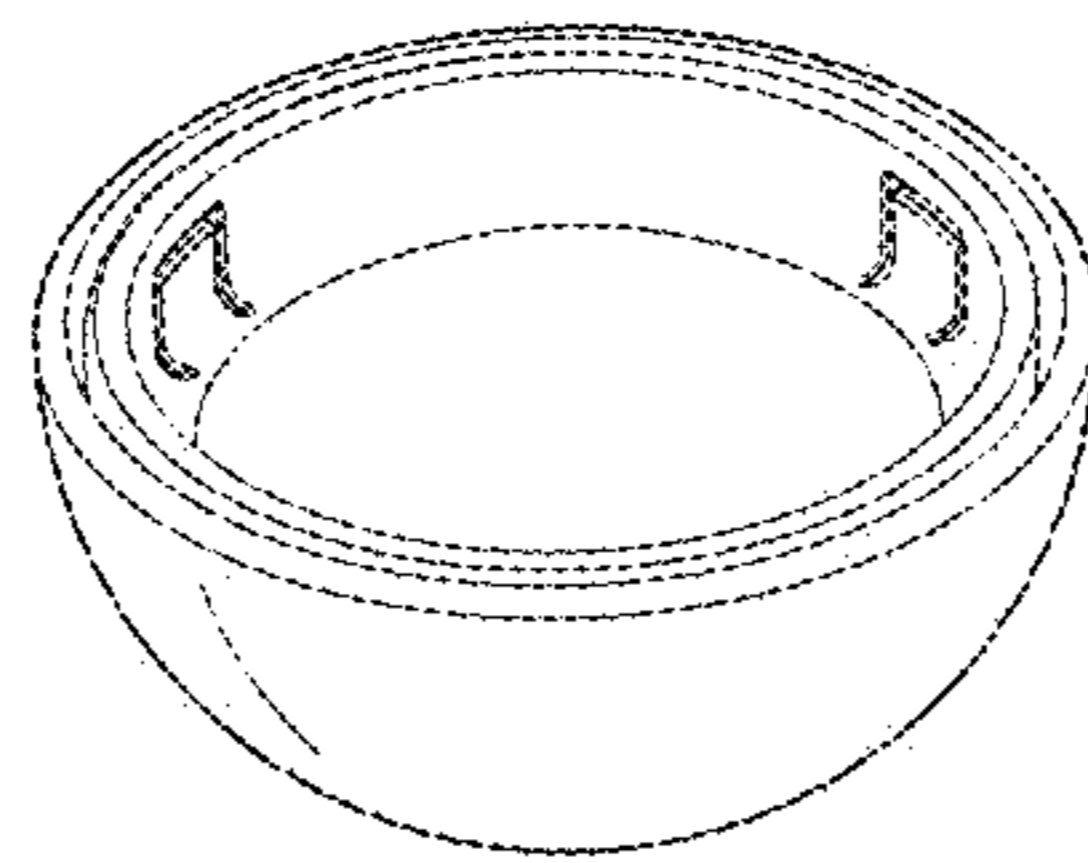

FIG. 24

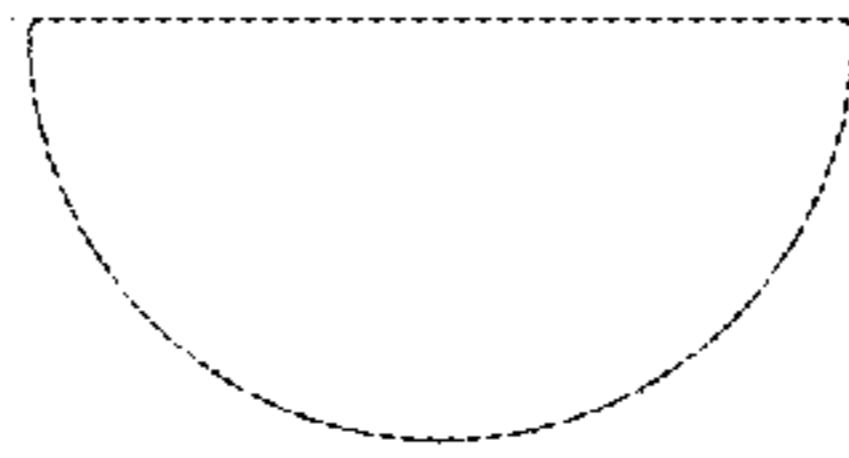

FIG. 25

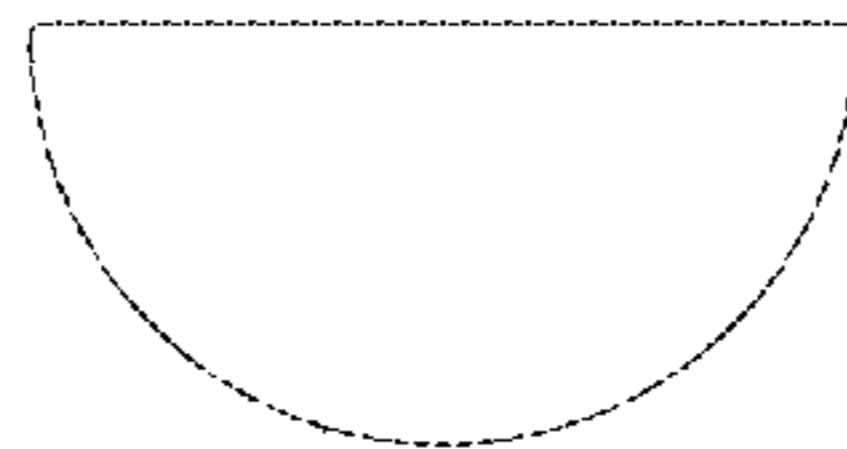

FIG. 26

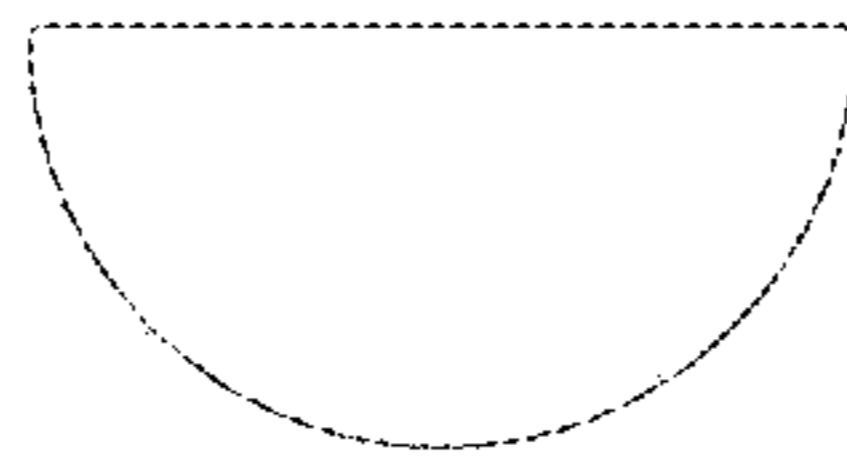

FIG. 27

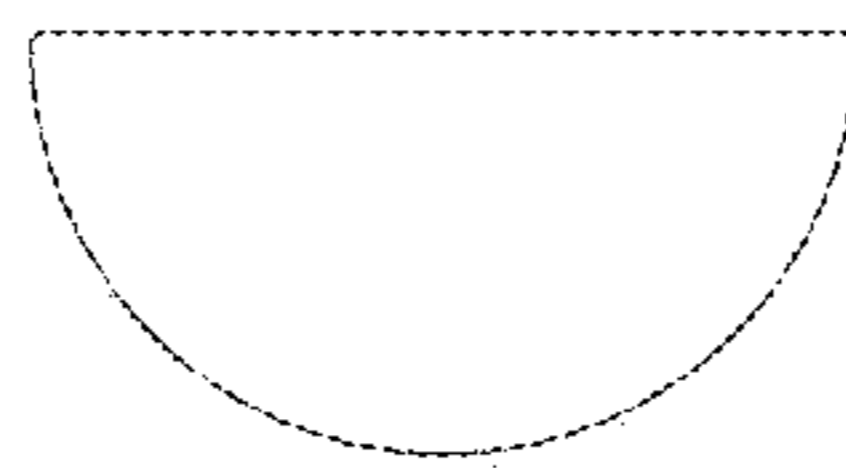

FIG. 28

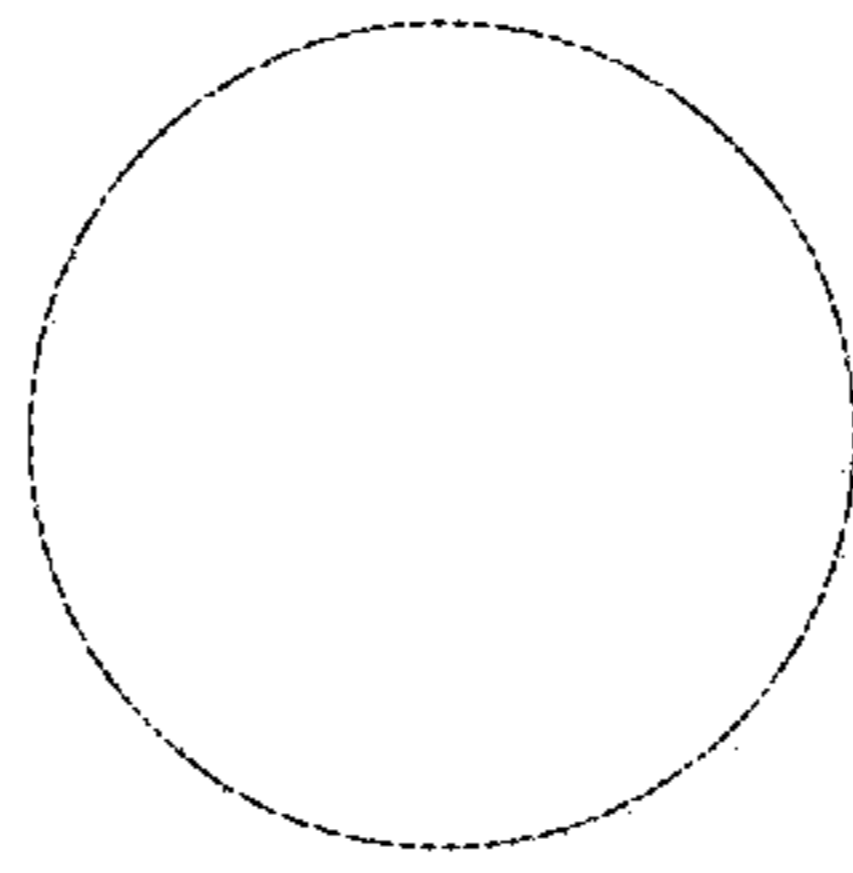

FIG. 29

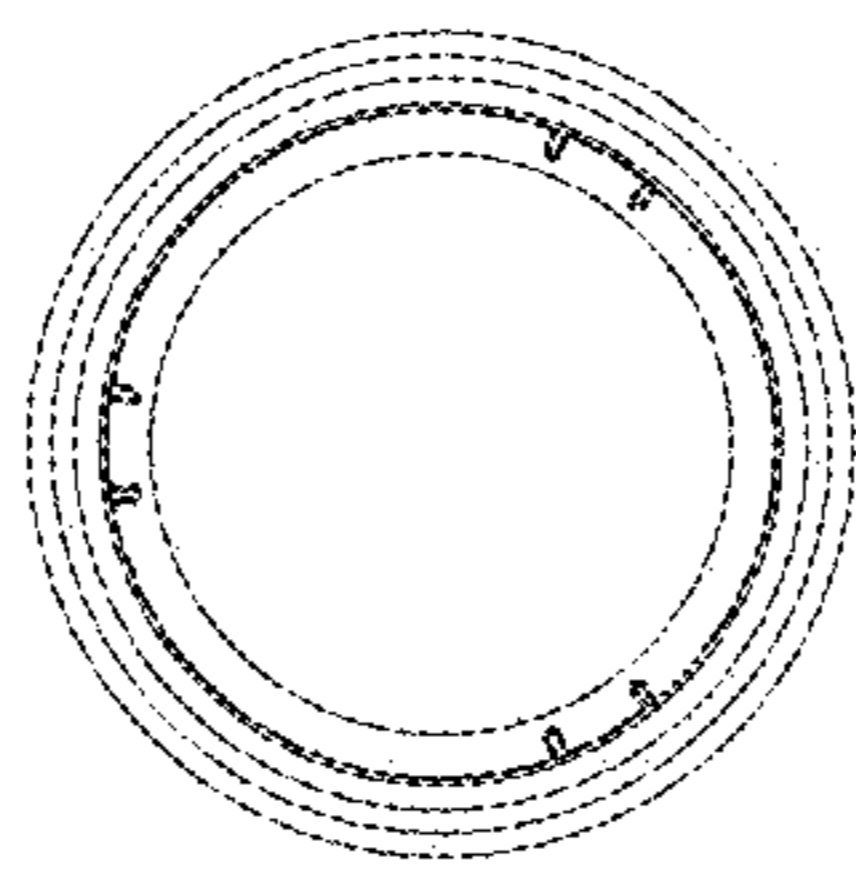

FIG. 30

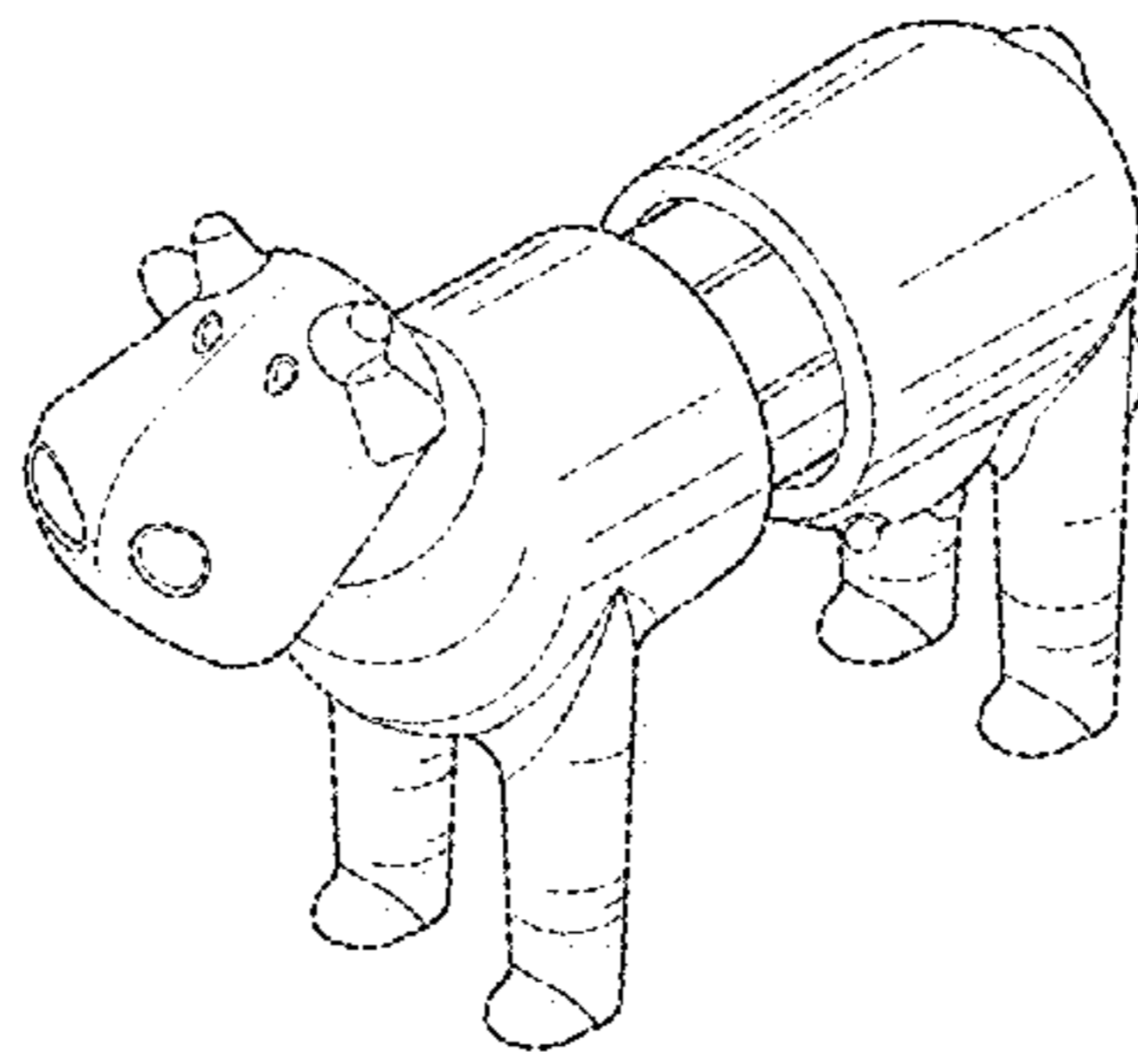

FIG. 31

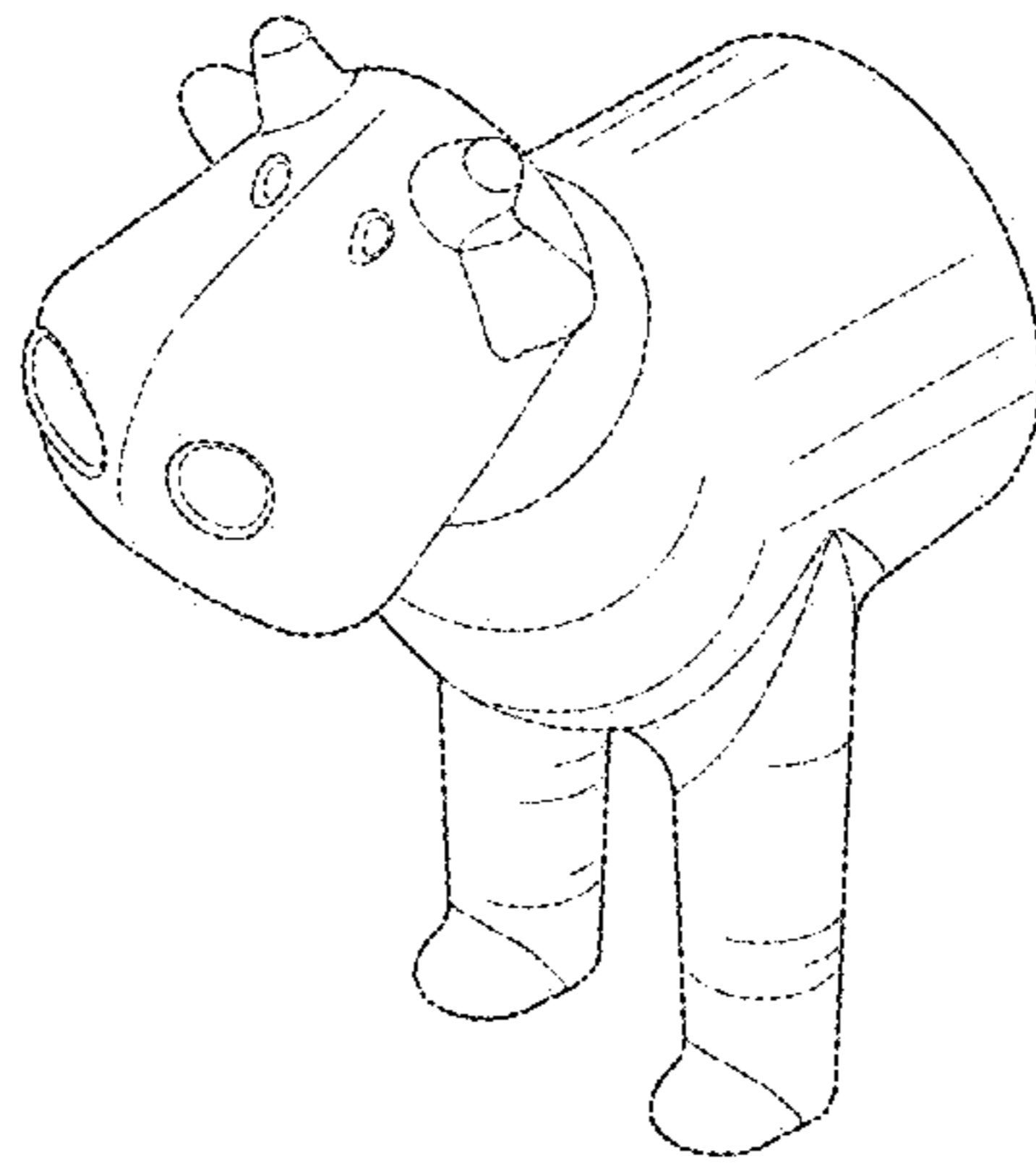

FIG. 32

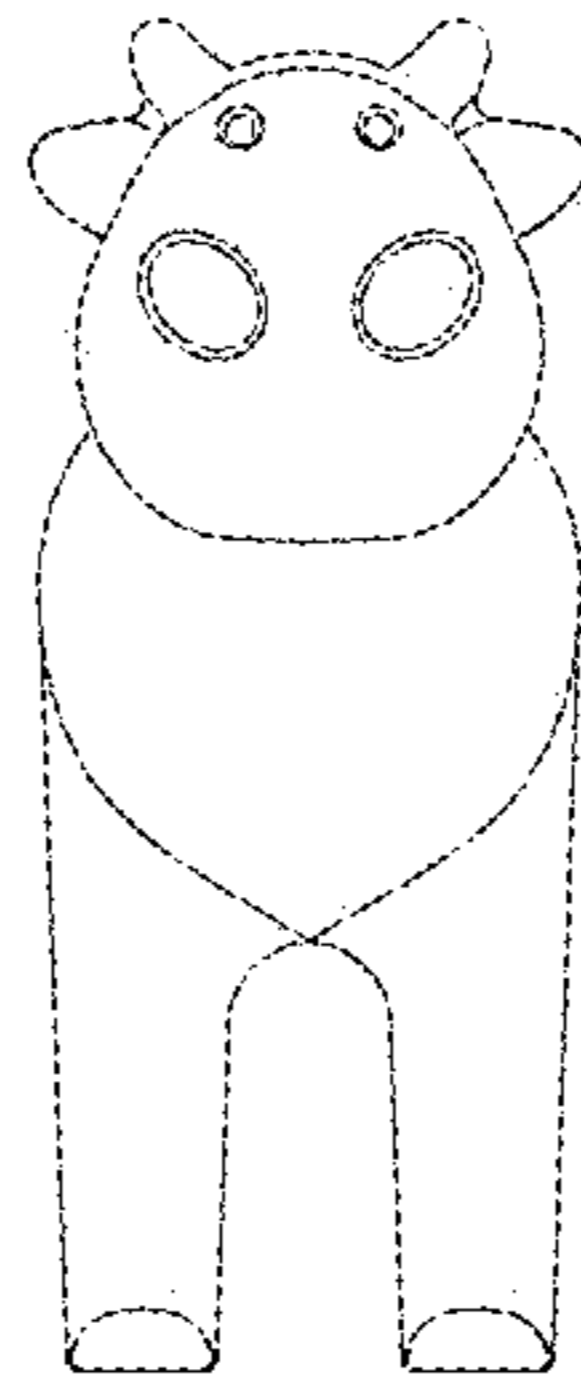

FIG. 33

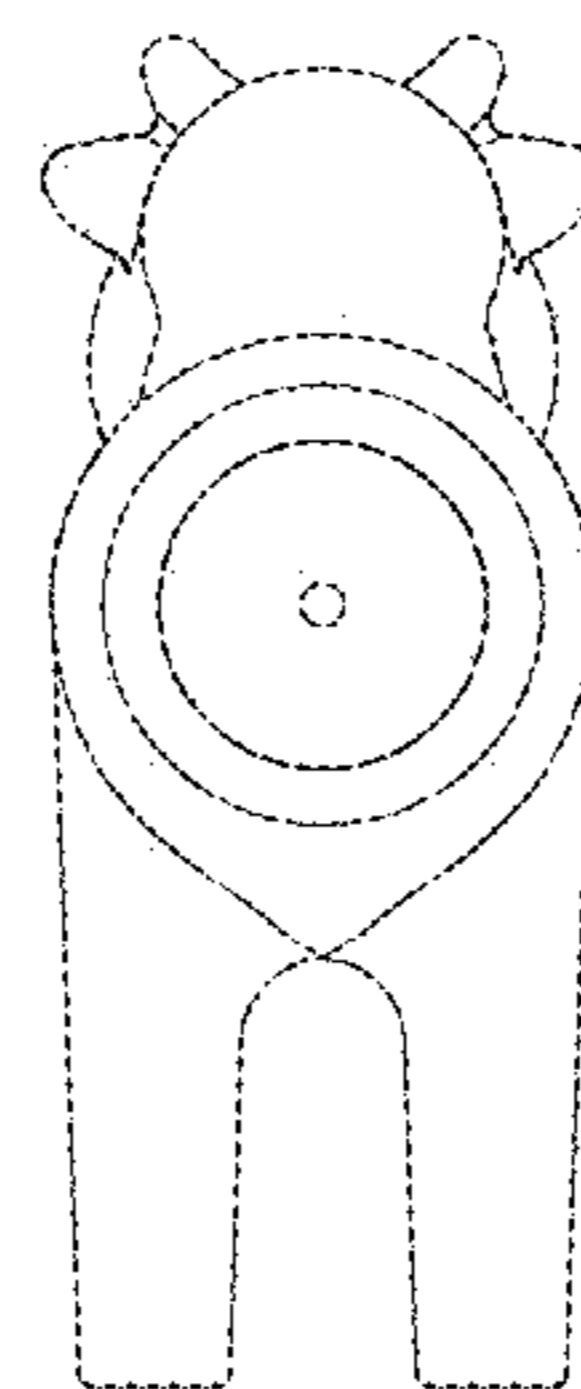

FIG. 34

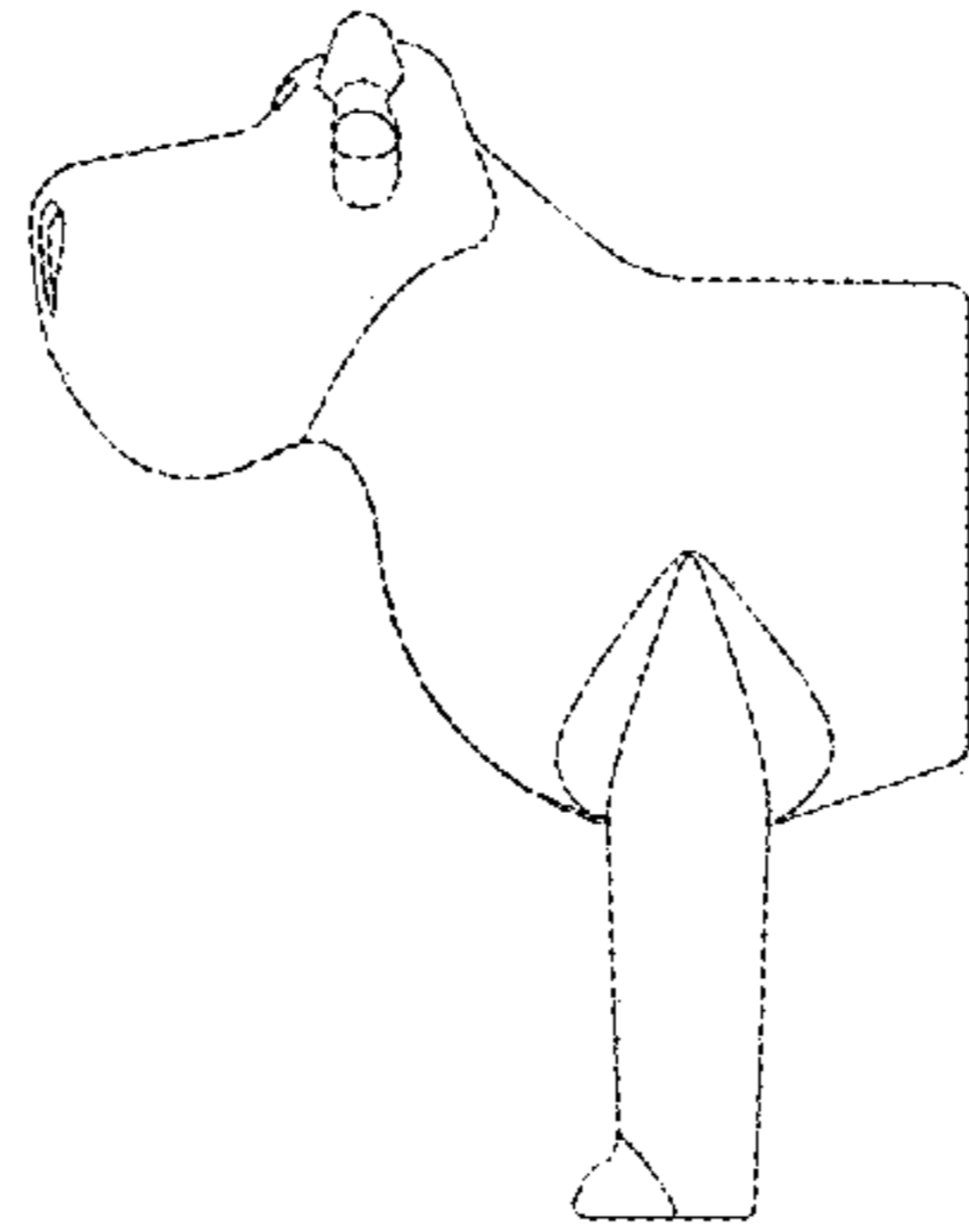

FIG. 35

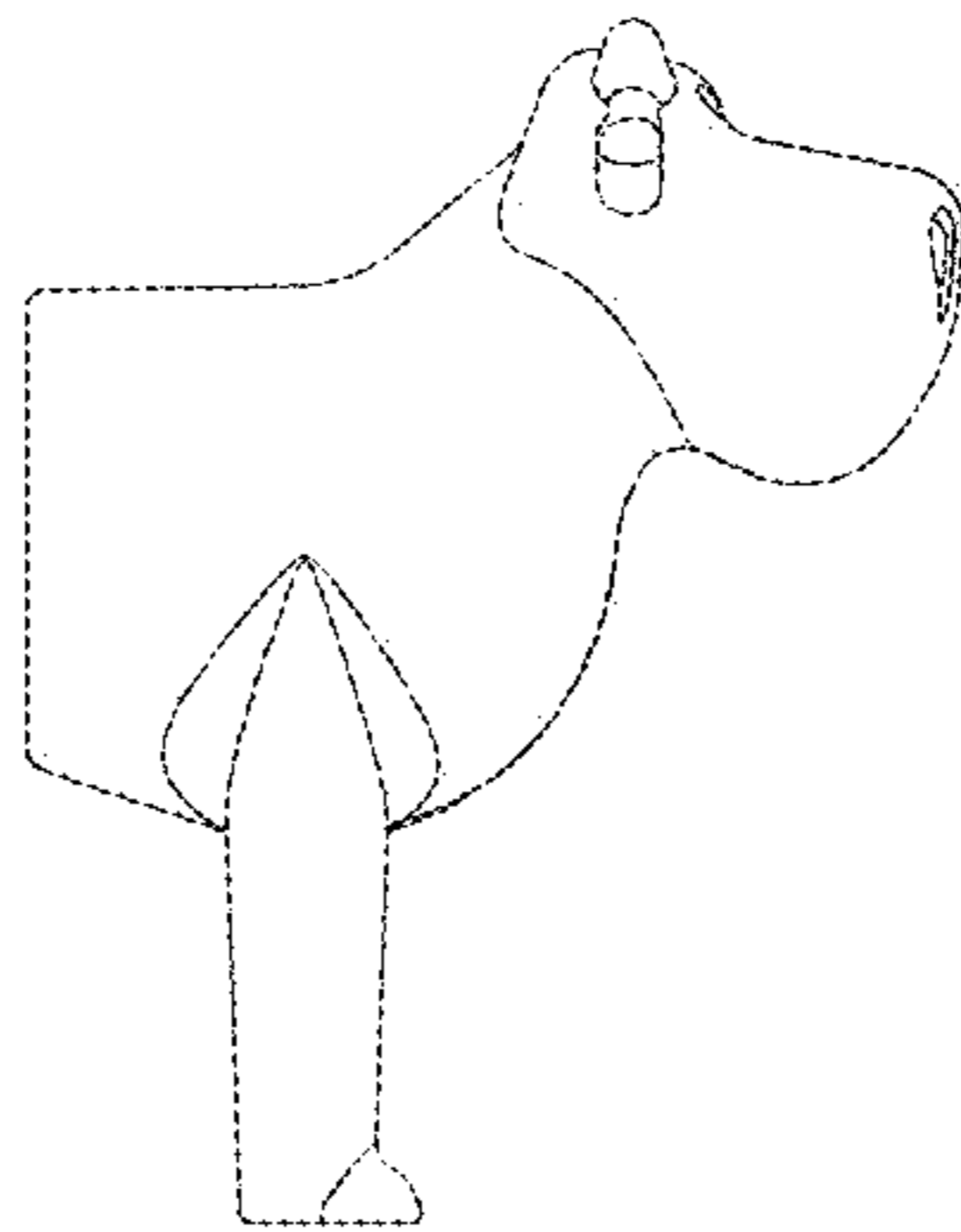

FIG. 36

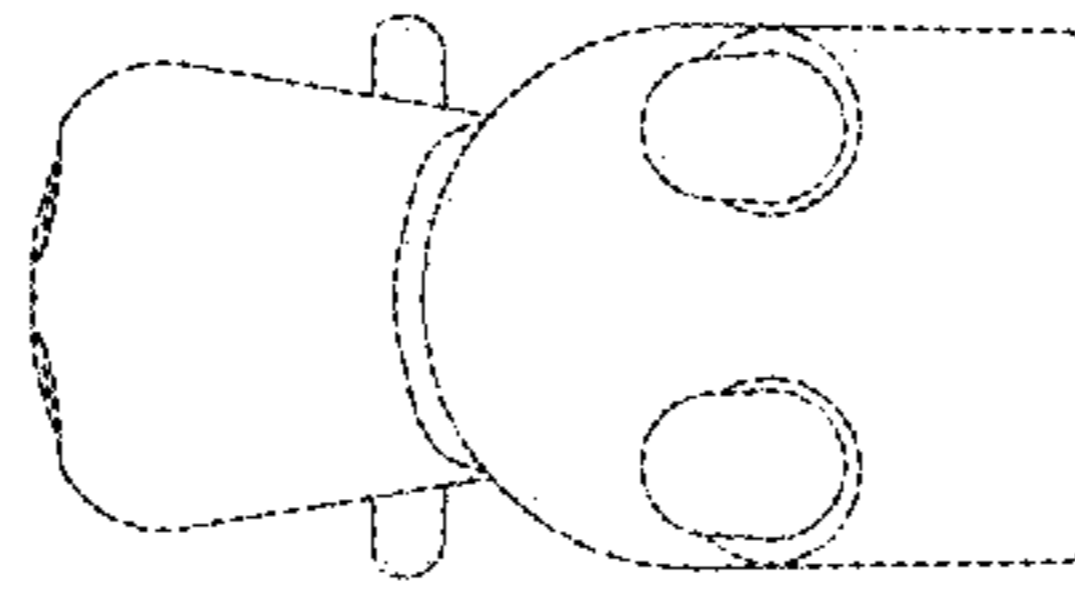

FIG. 37

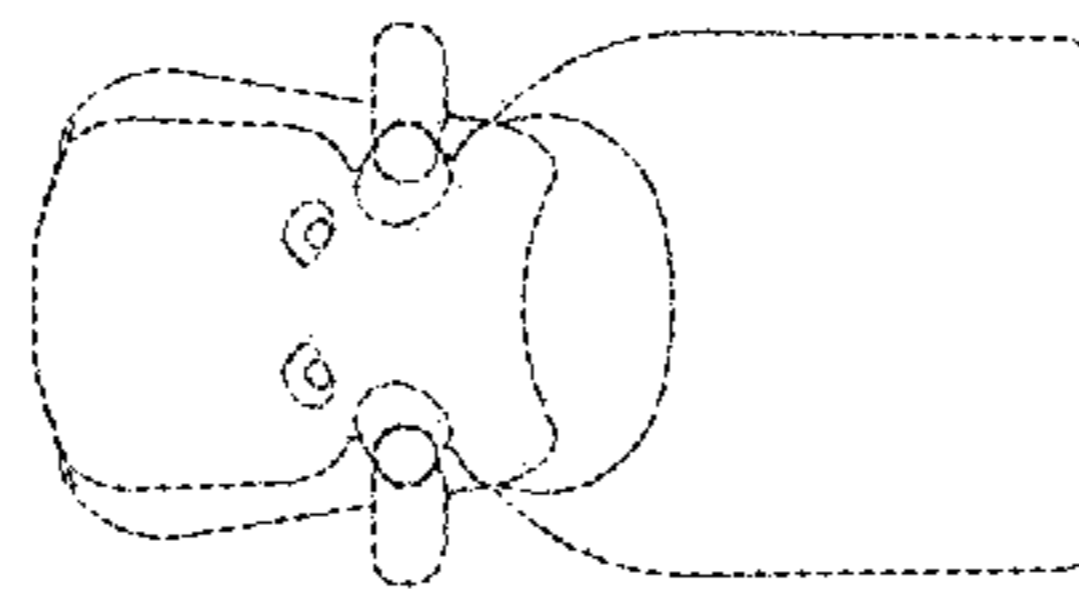

FIG. 38

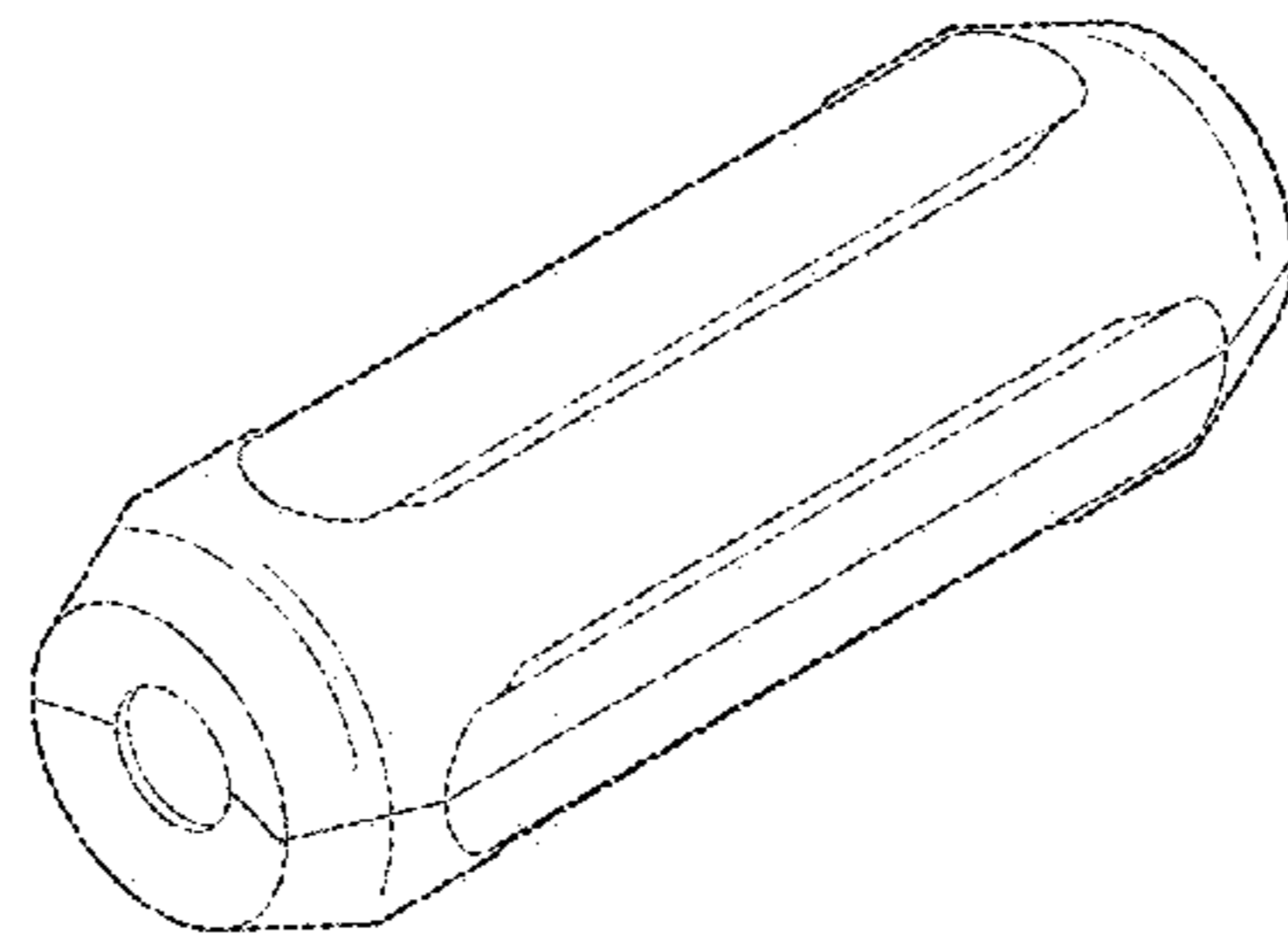

FIG. 39

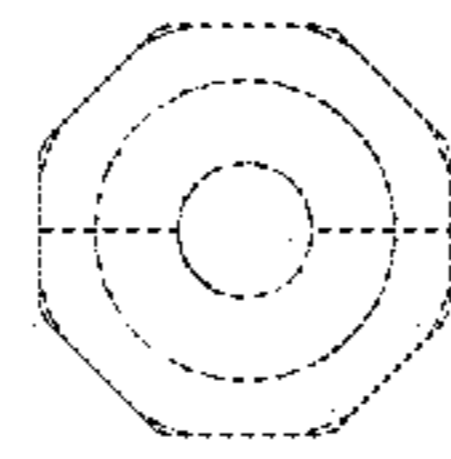

FIG. 40

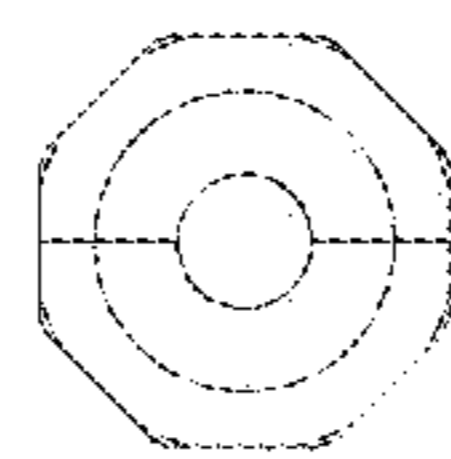

FIG. 41

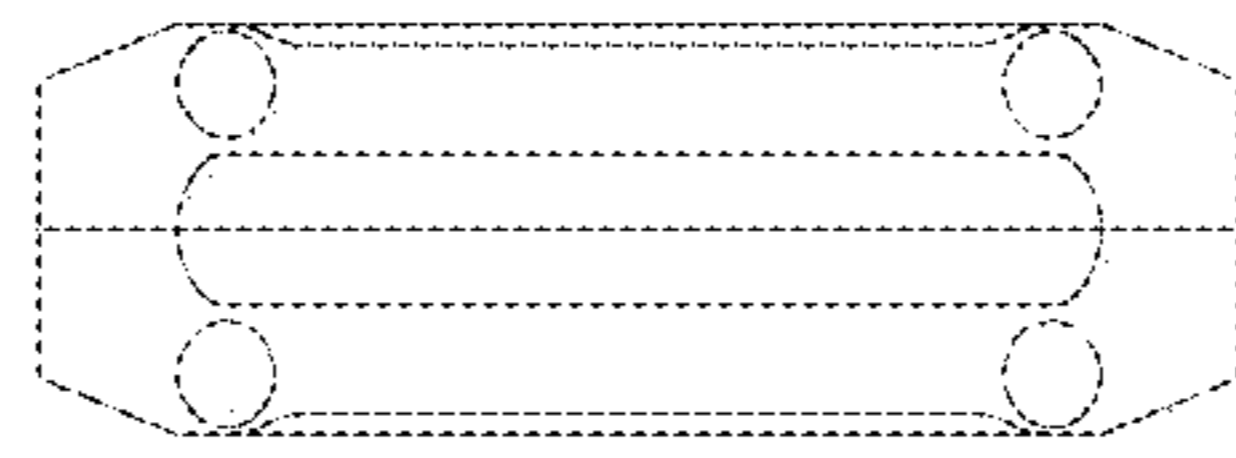

FIG. 42

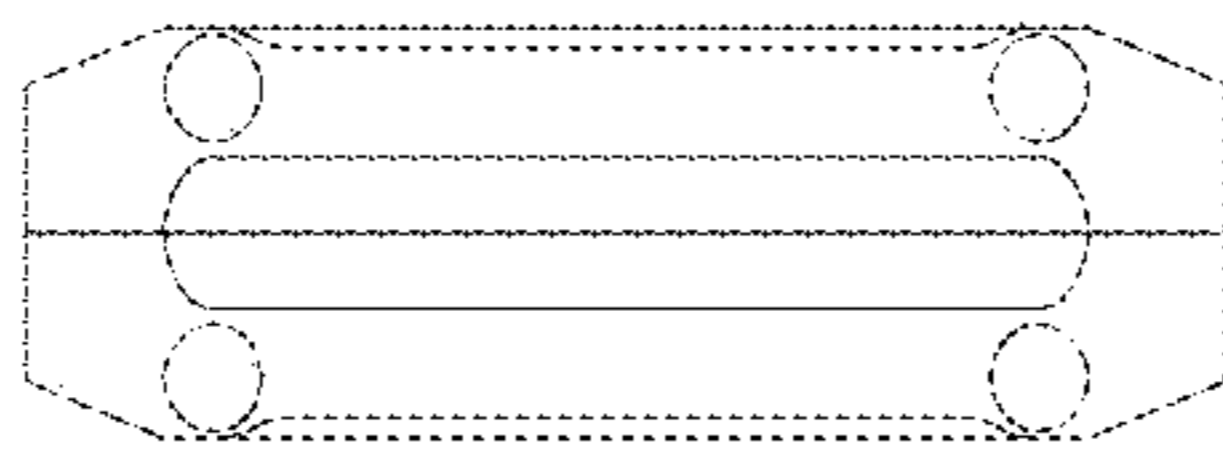

FIG. 43

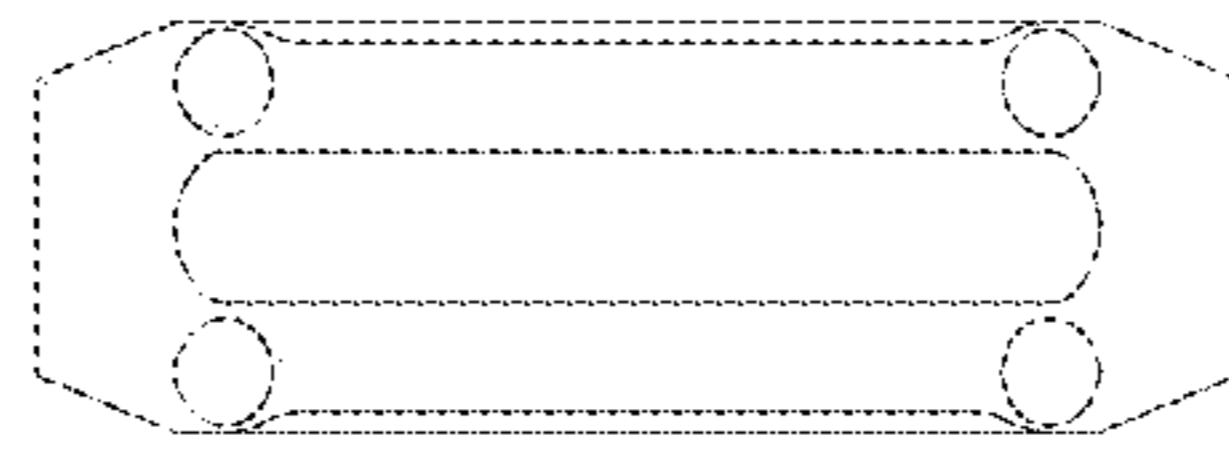

FIG. 44

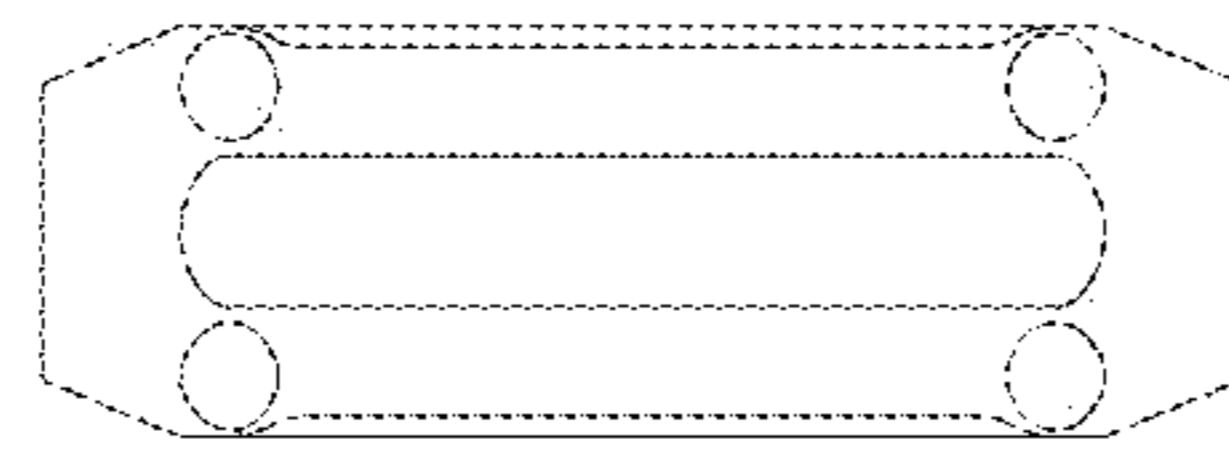

FIG. 45

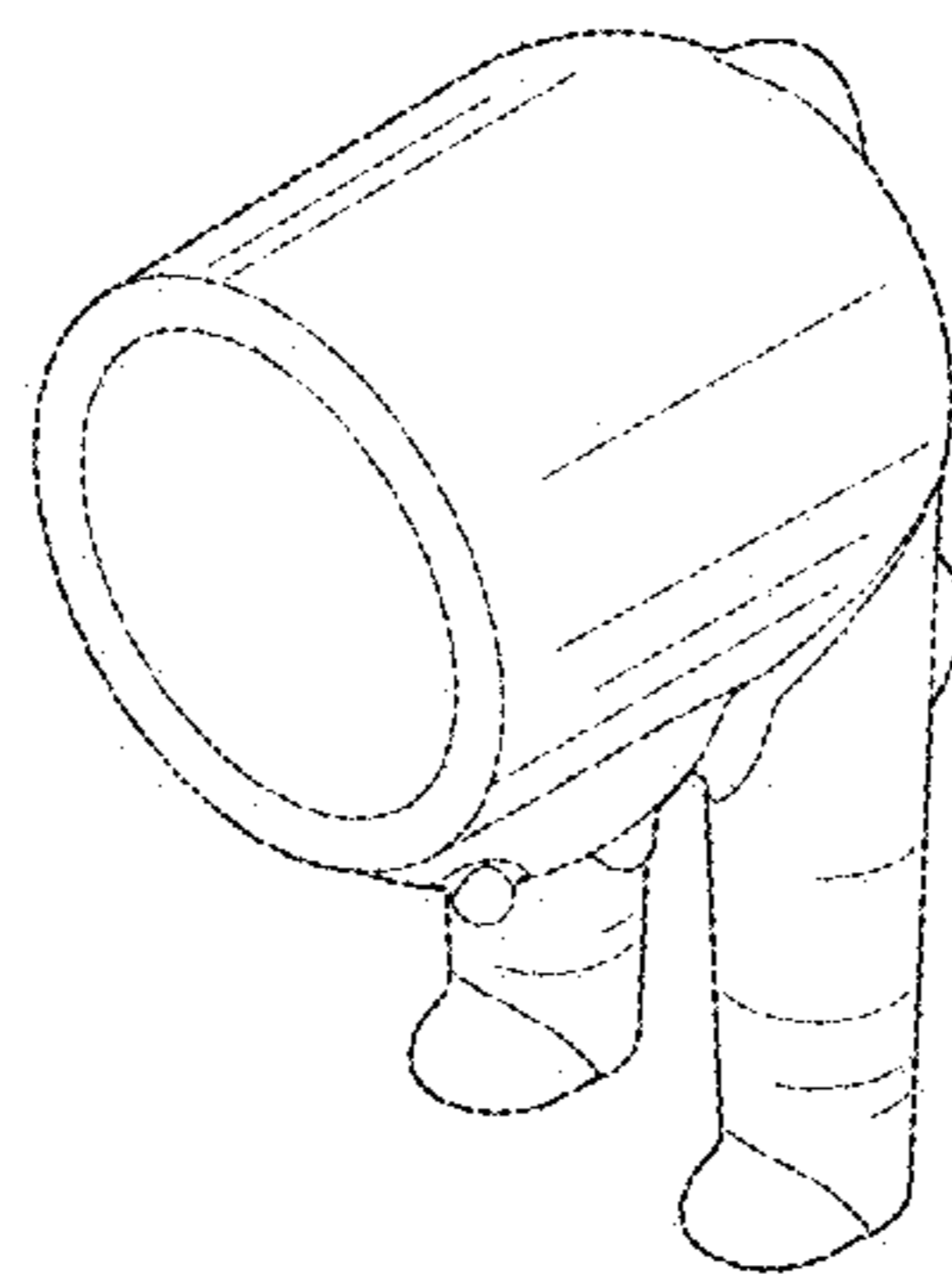

FIG. 46

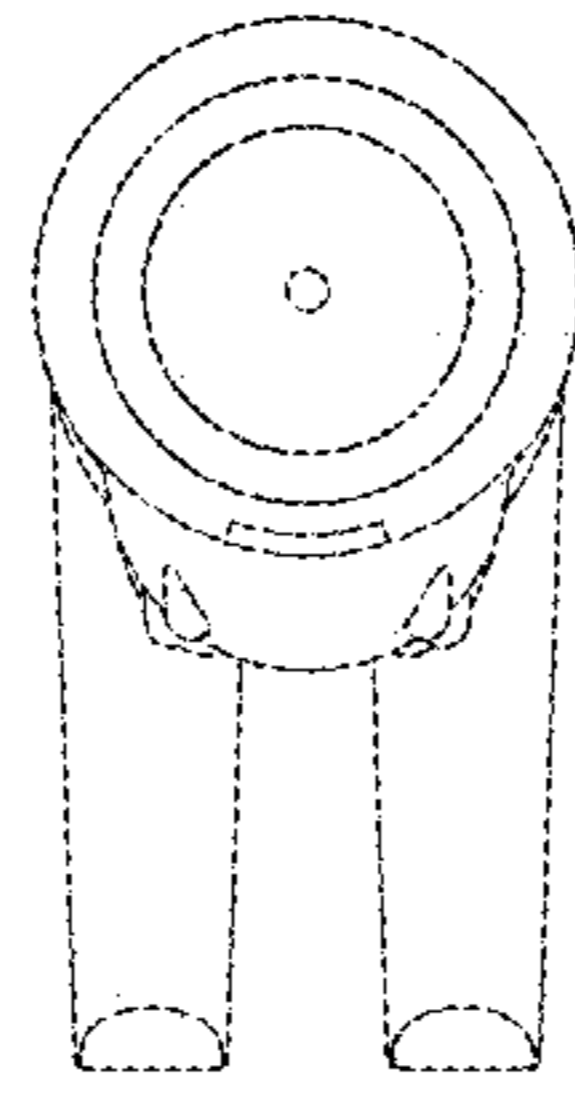

FIG. 47

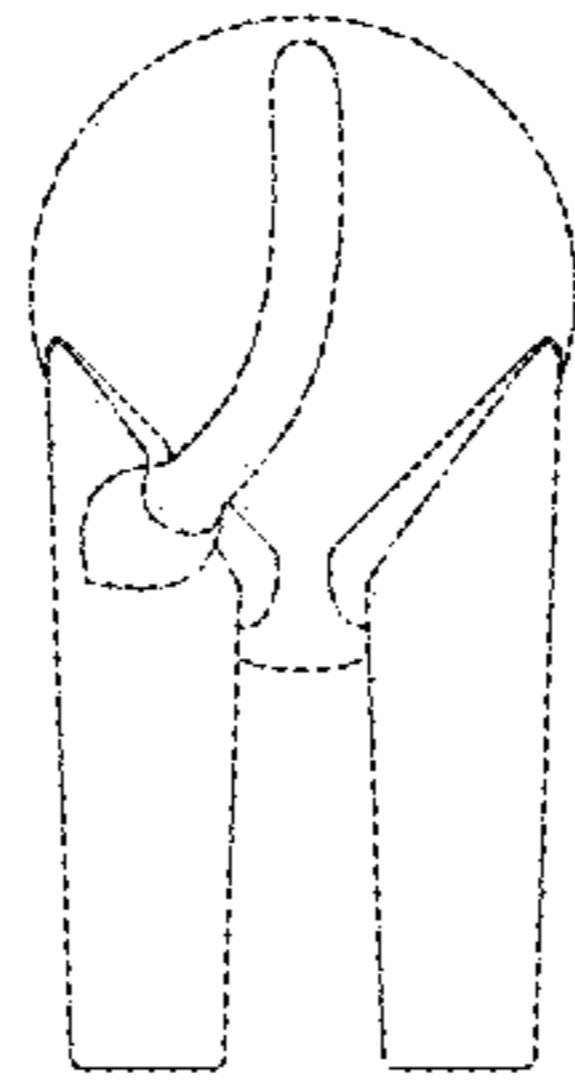

FIG. 48

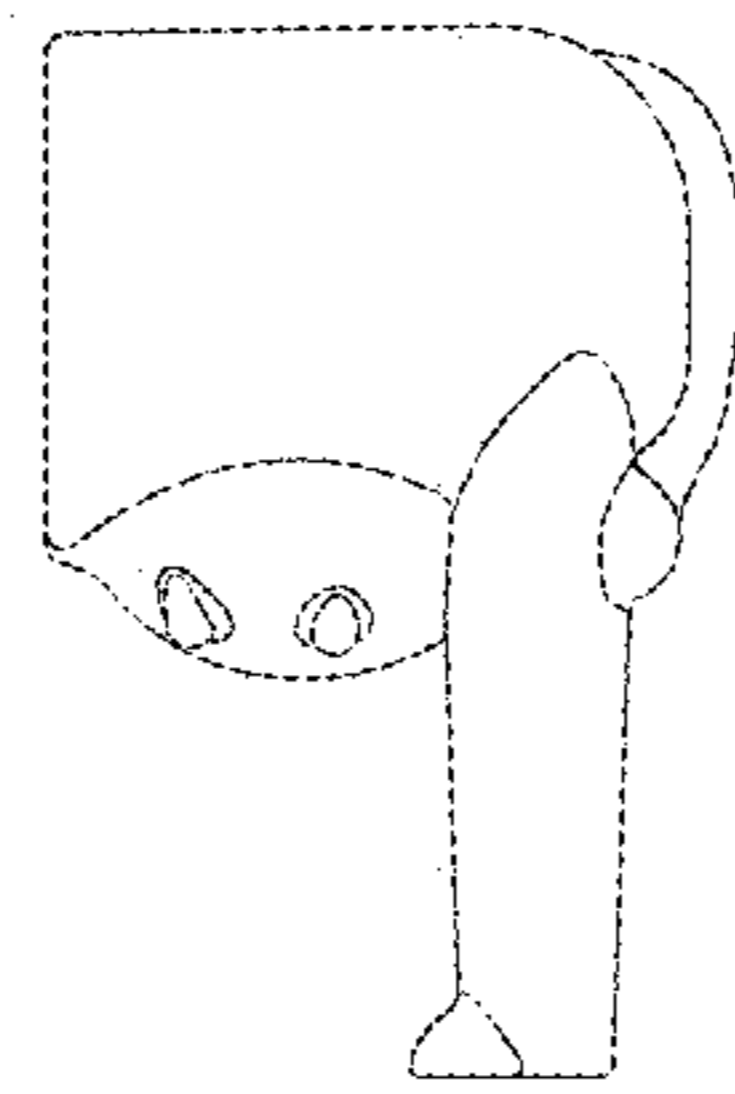

FIG. 49

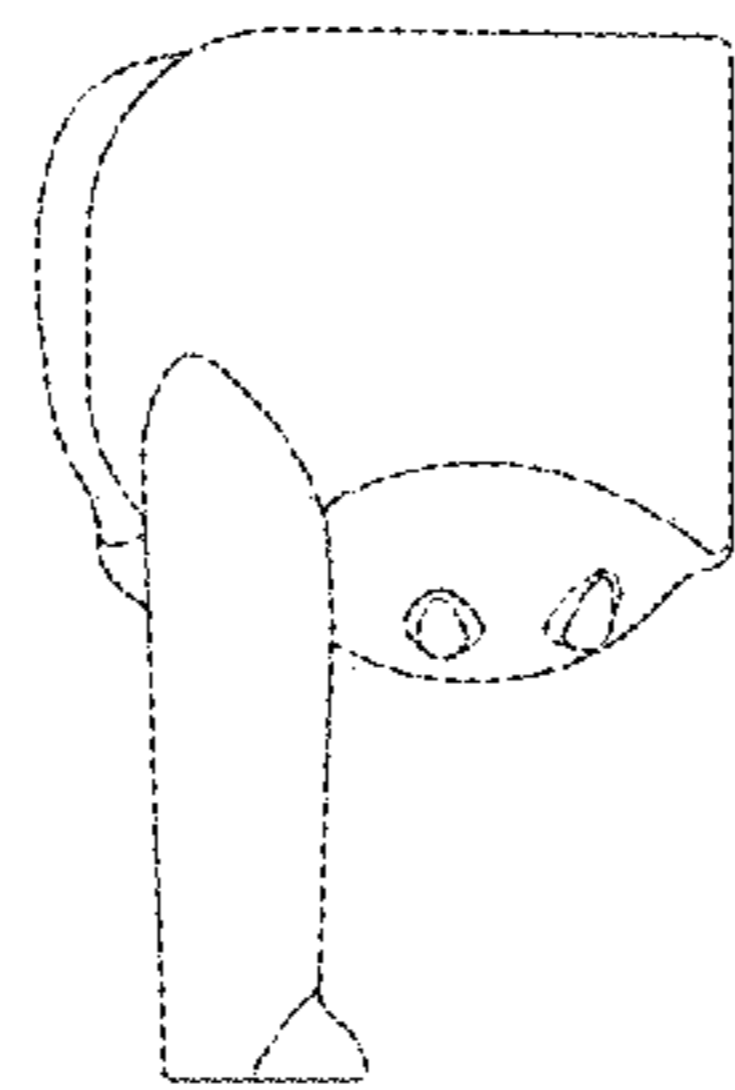

FIG. 50

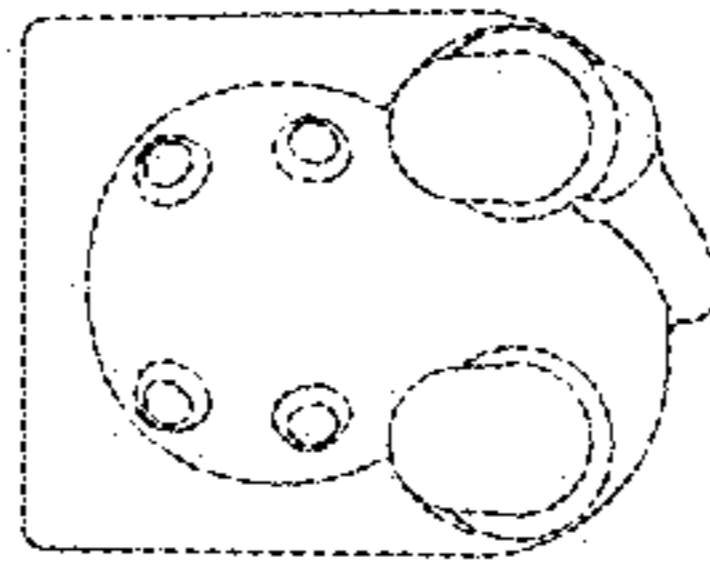

FIG. 51

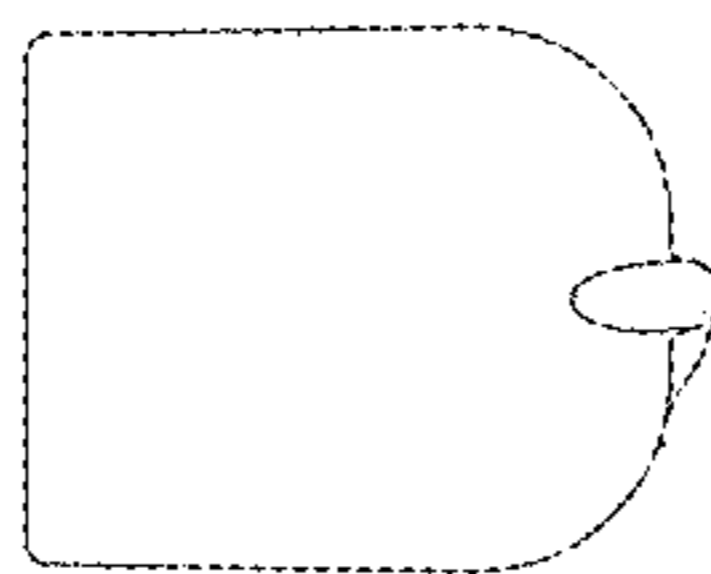

FIG. 52

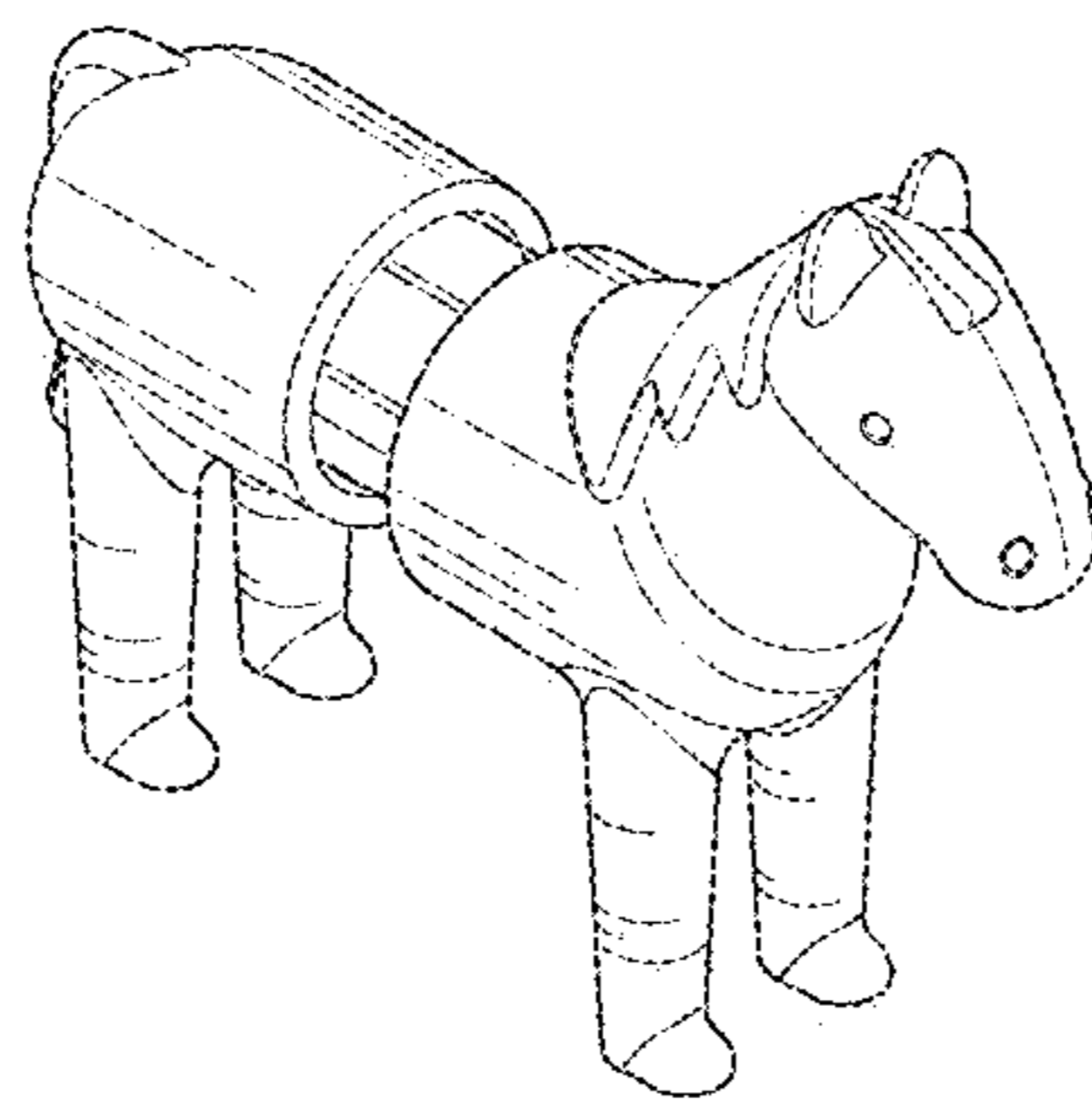

FIG. 53

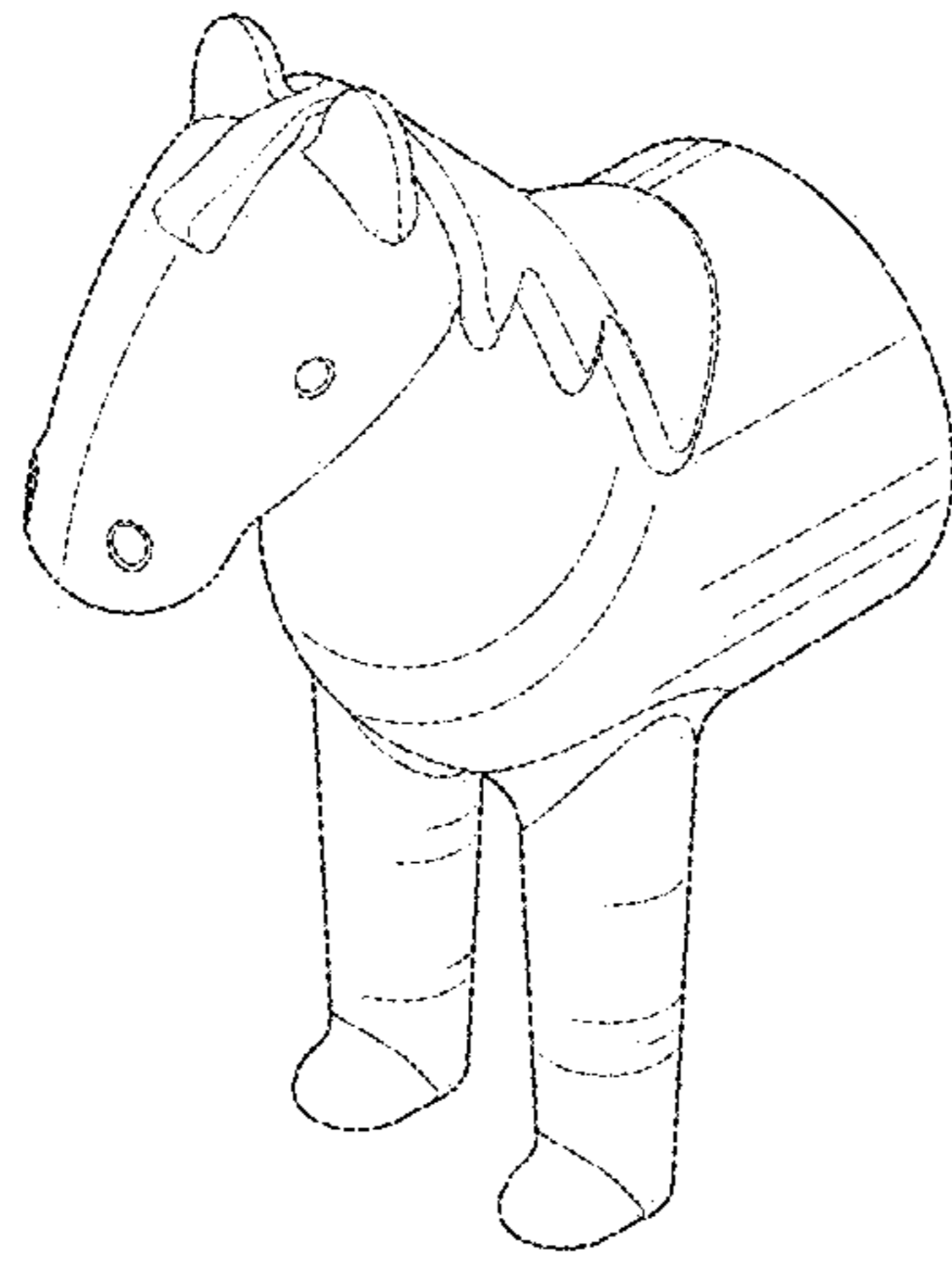

FIG. 54

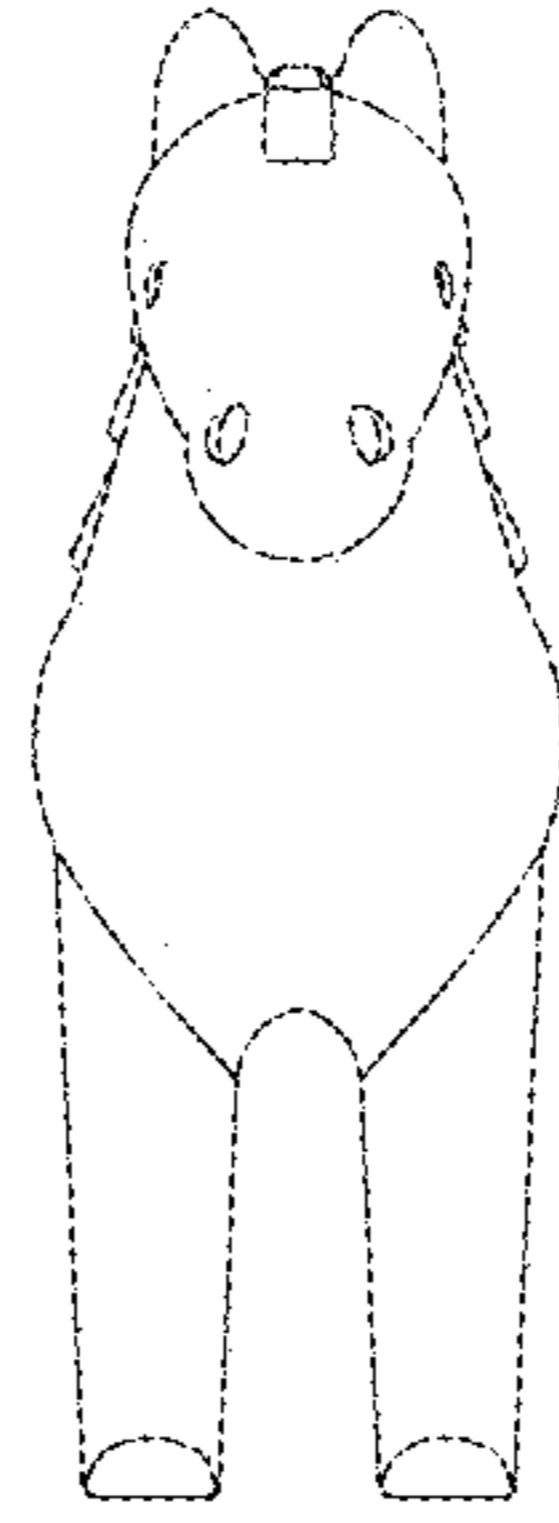

FIG. 55

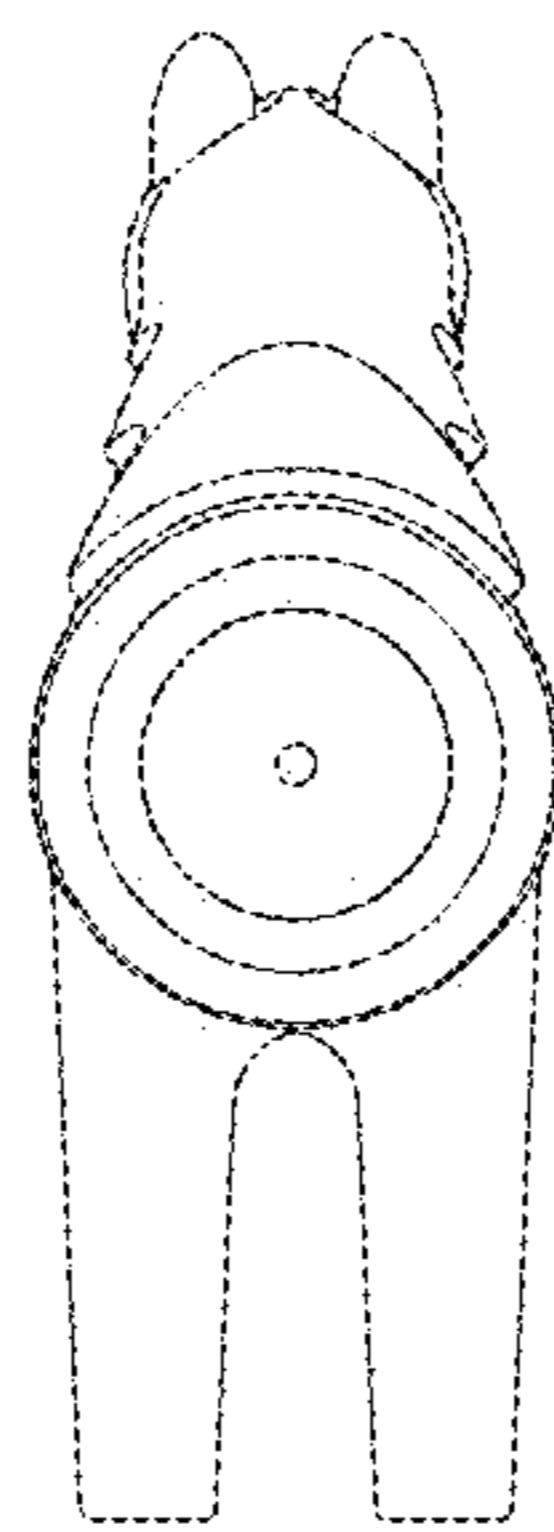

FIG. 56

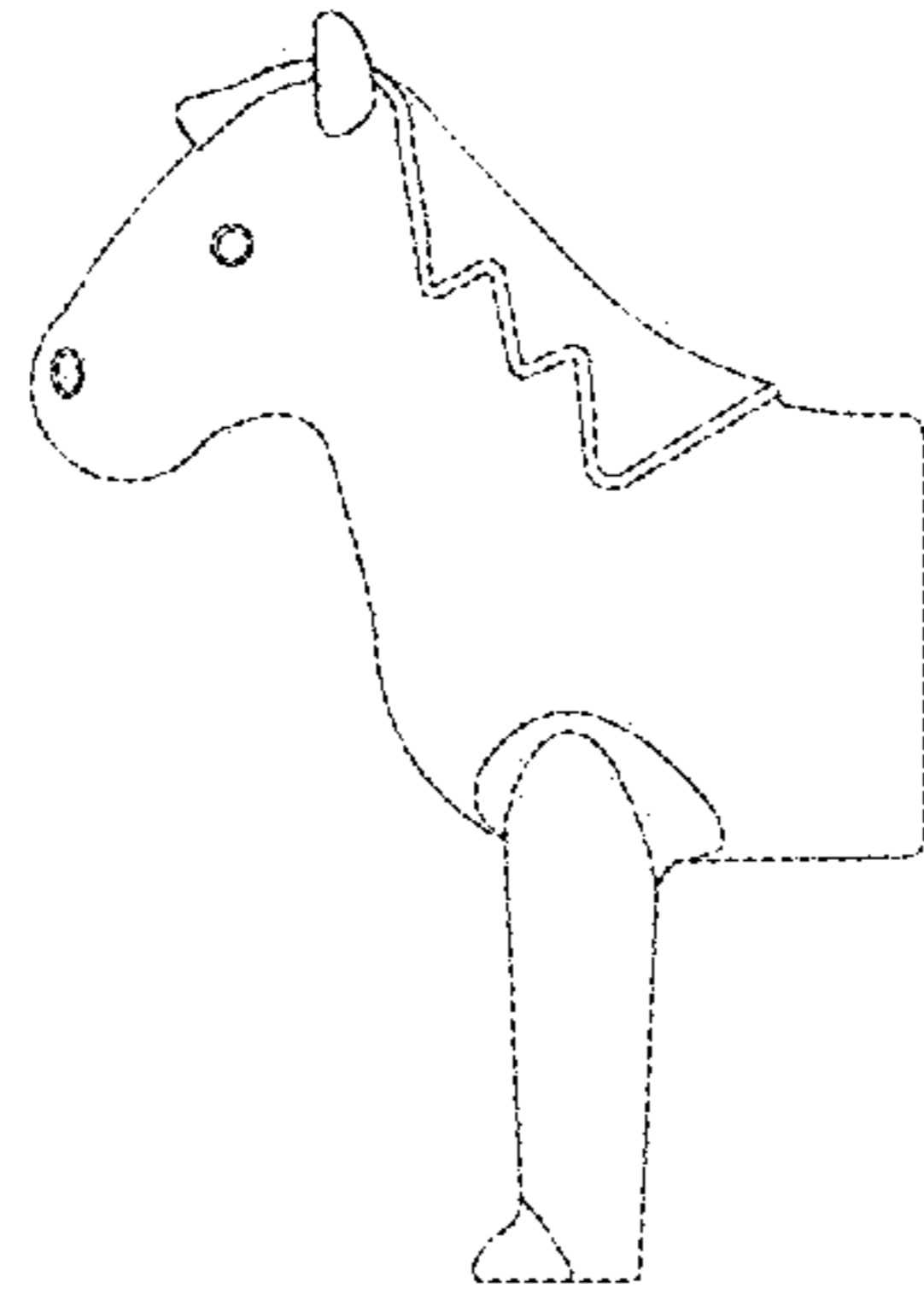

FIG. 57

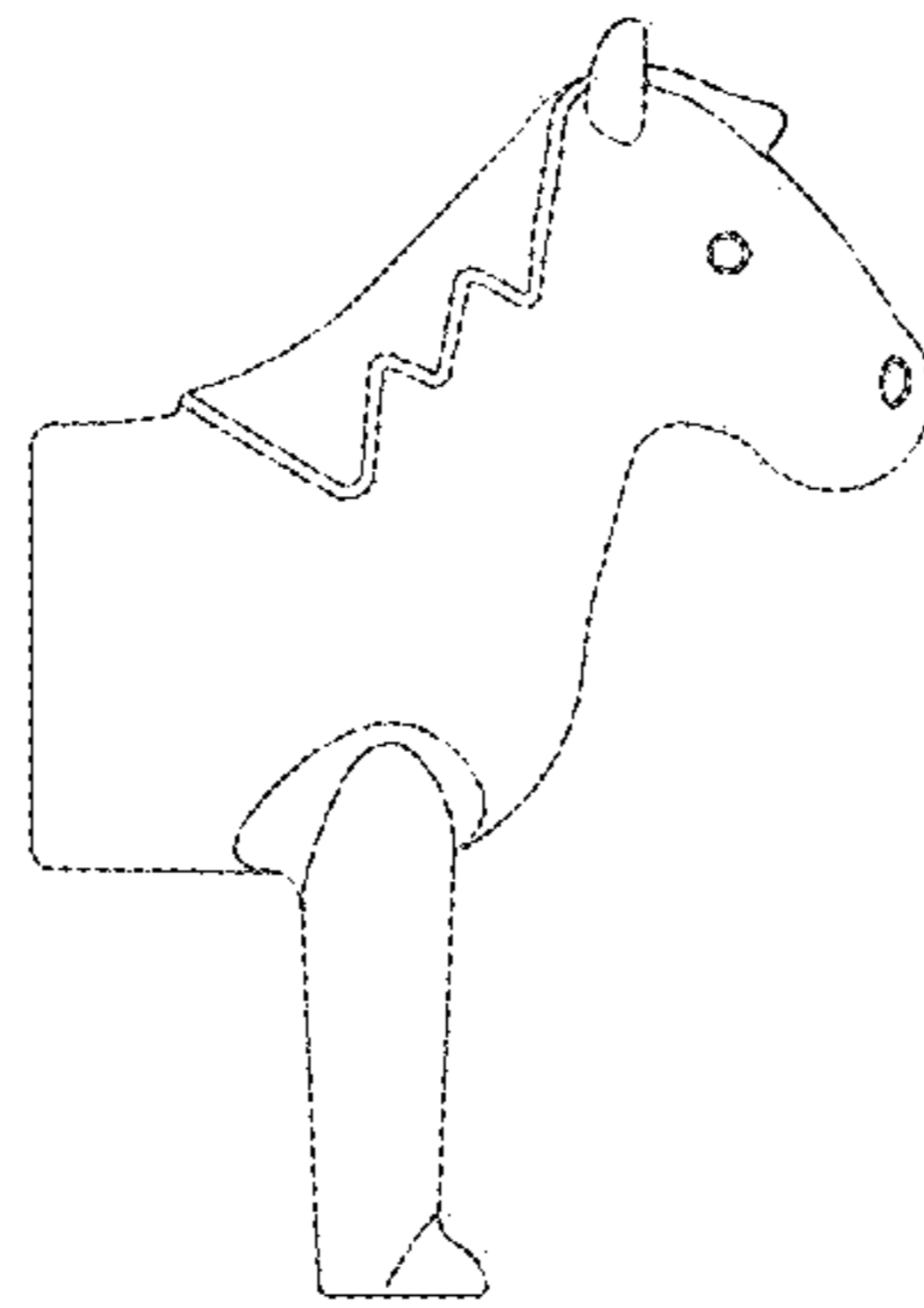

FIG. 58

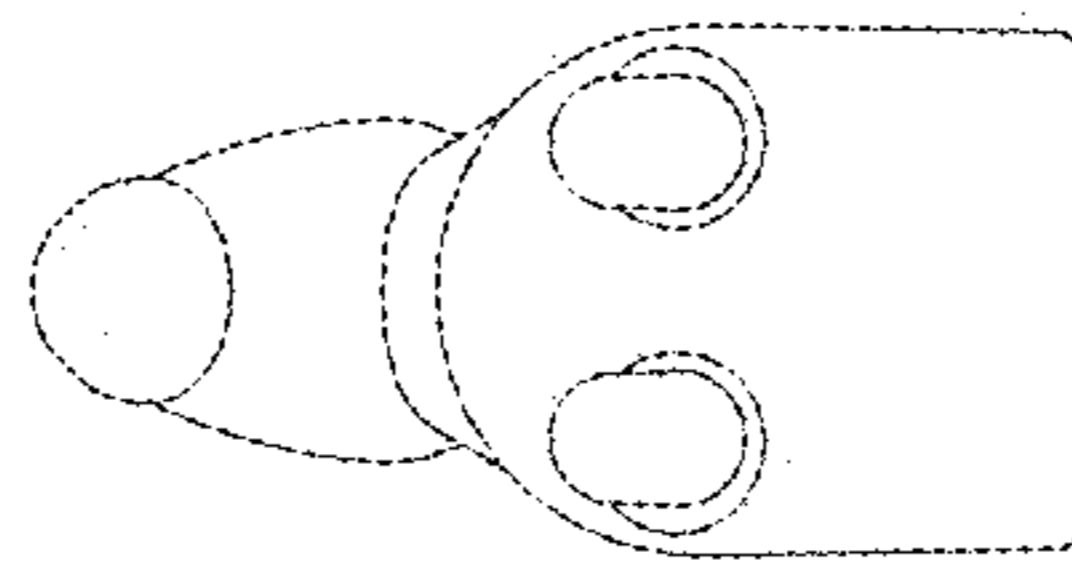

FIG. 59

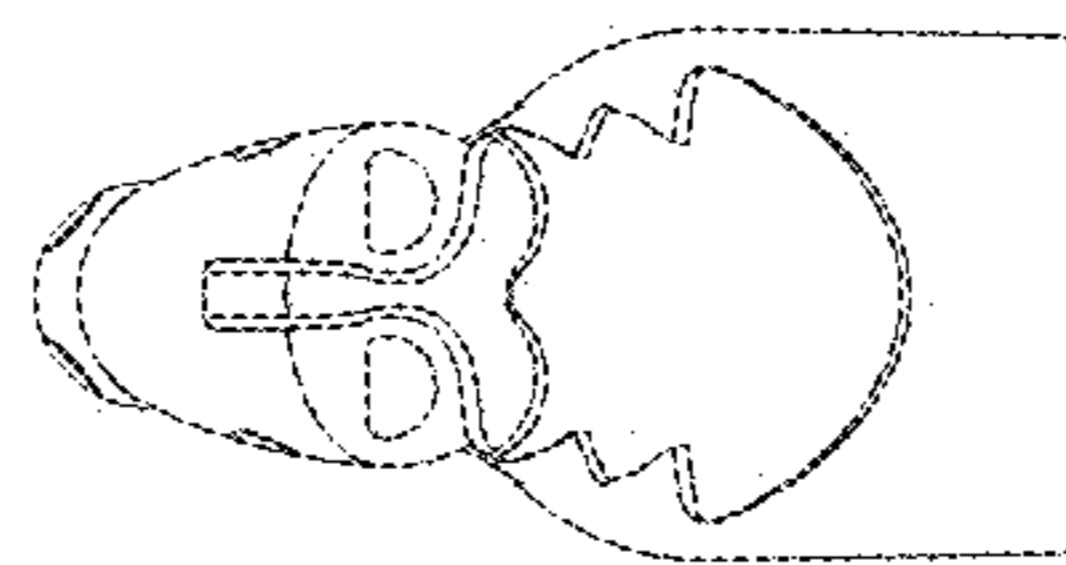

FIG. 60

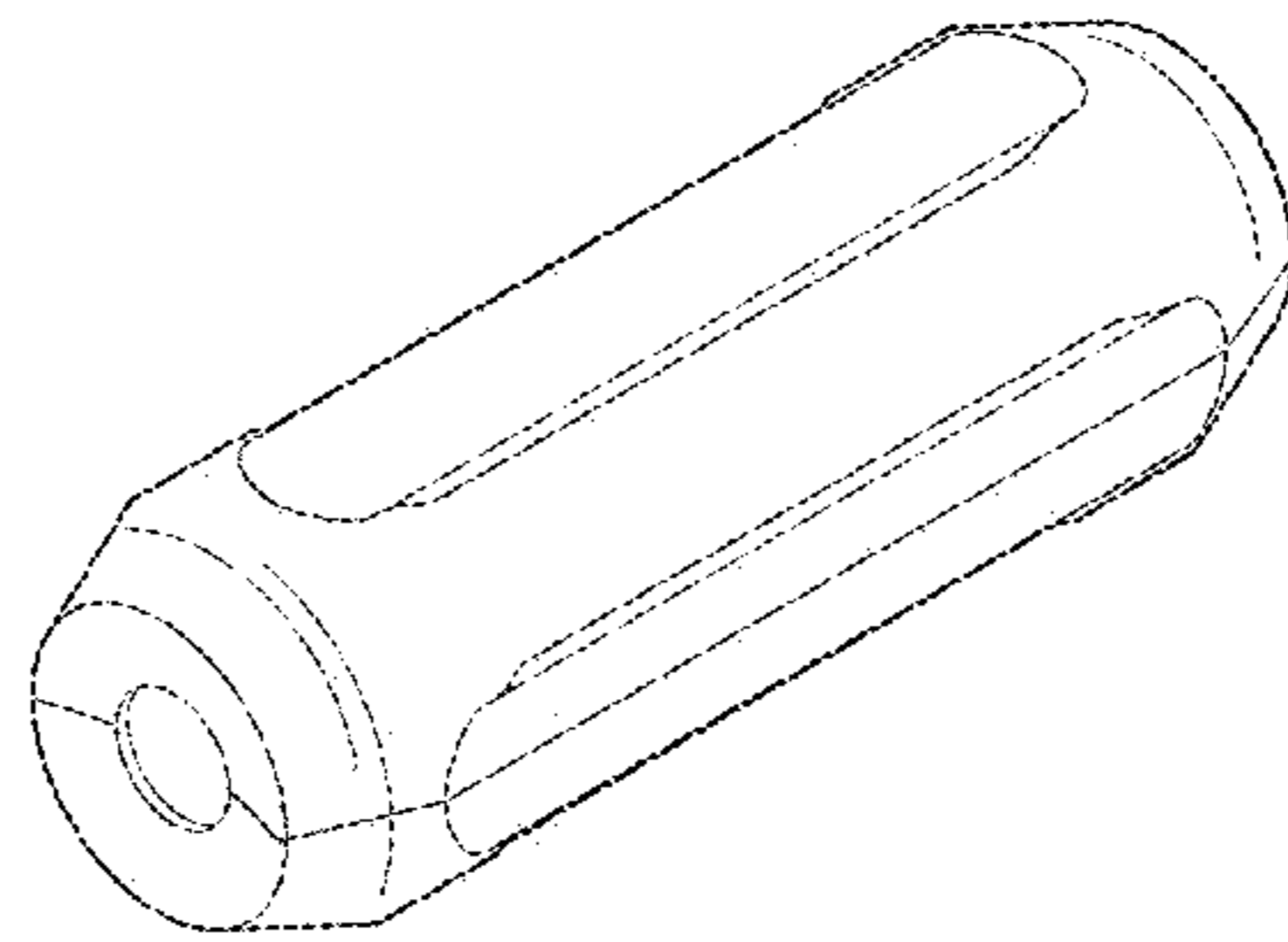

FIG. 61

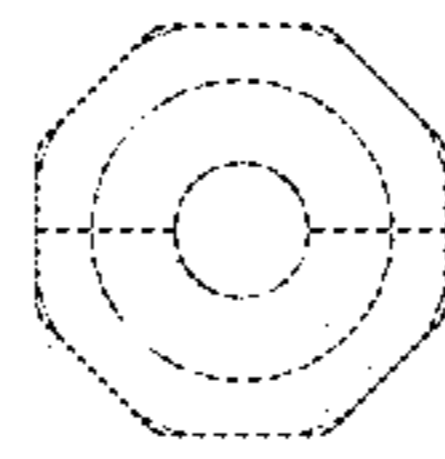

FIG. 62

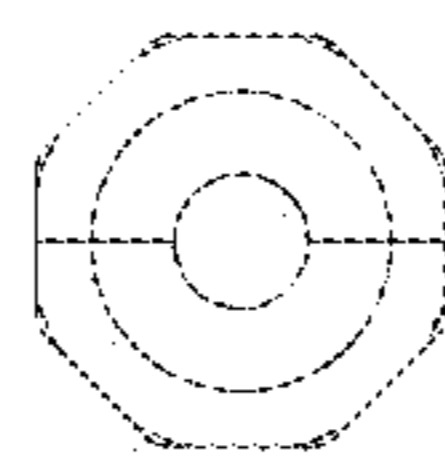

FIG. 63

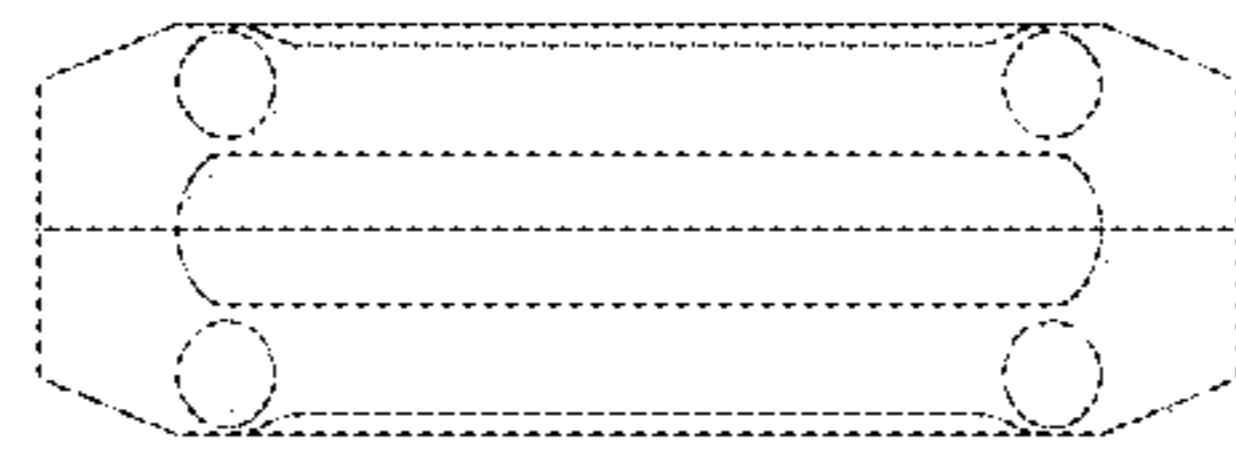

FIG. 64

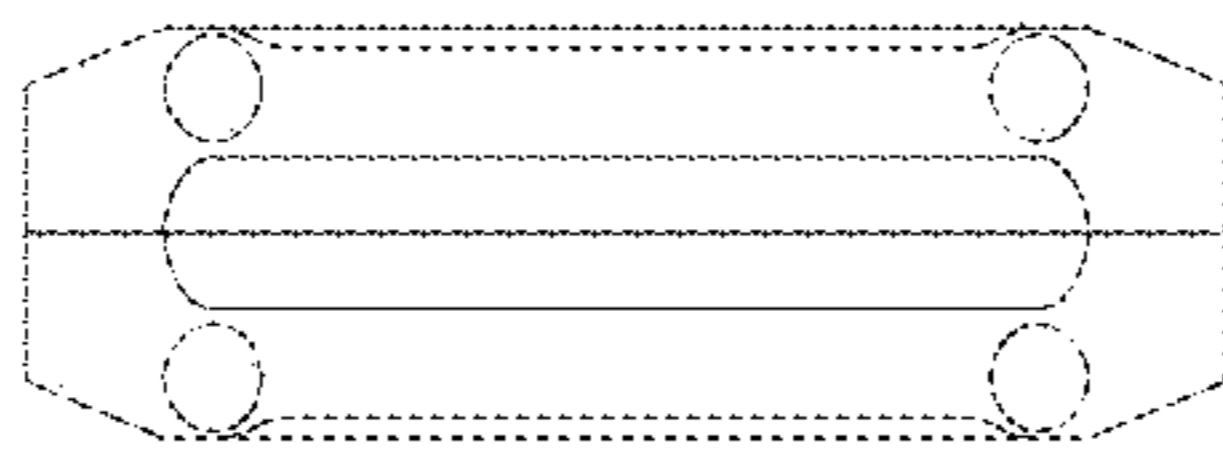

FIG. 65

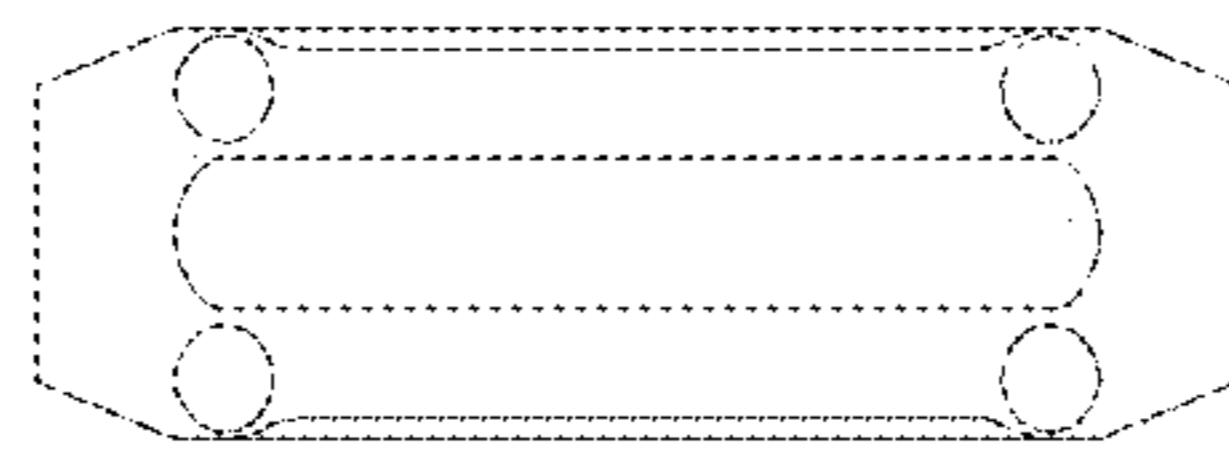

FIG. 66

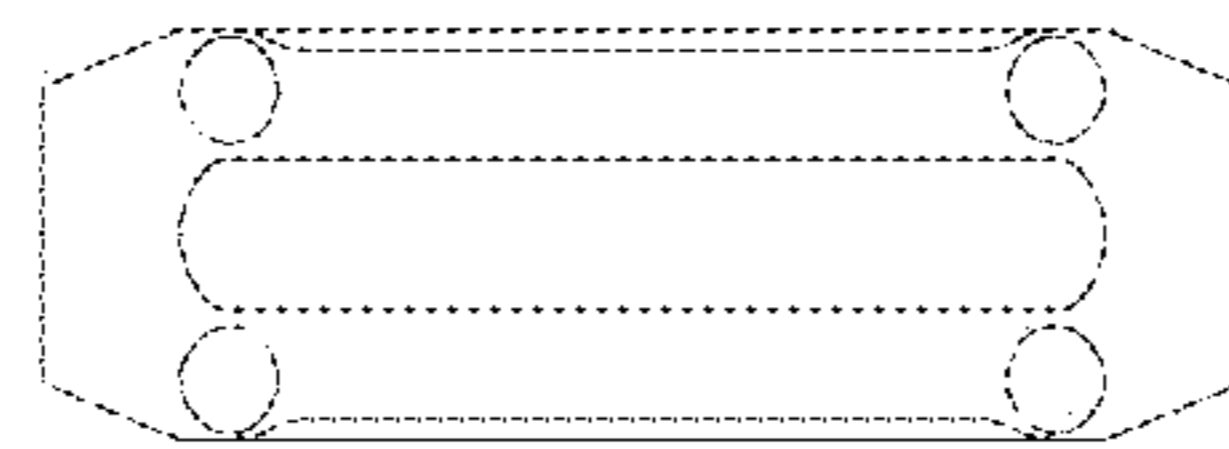

FIG. 67

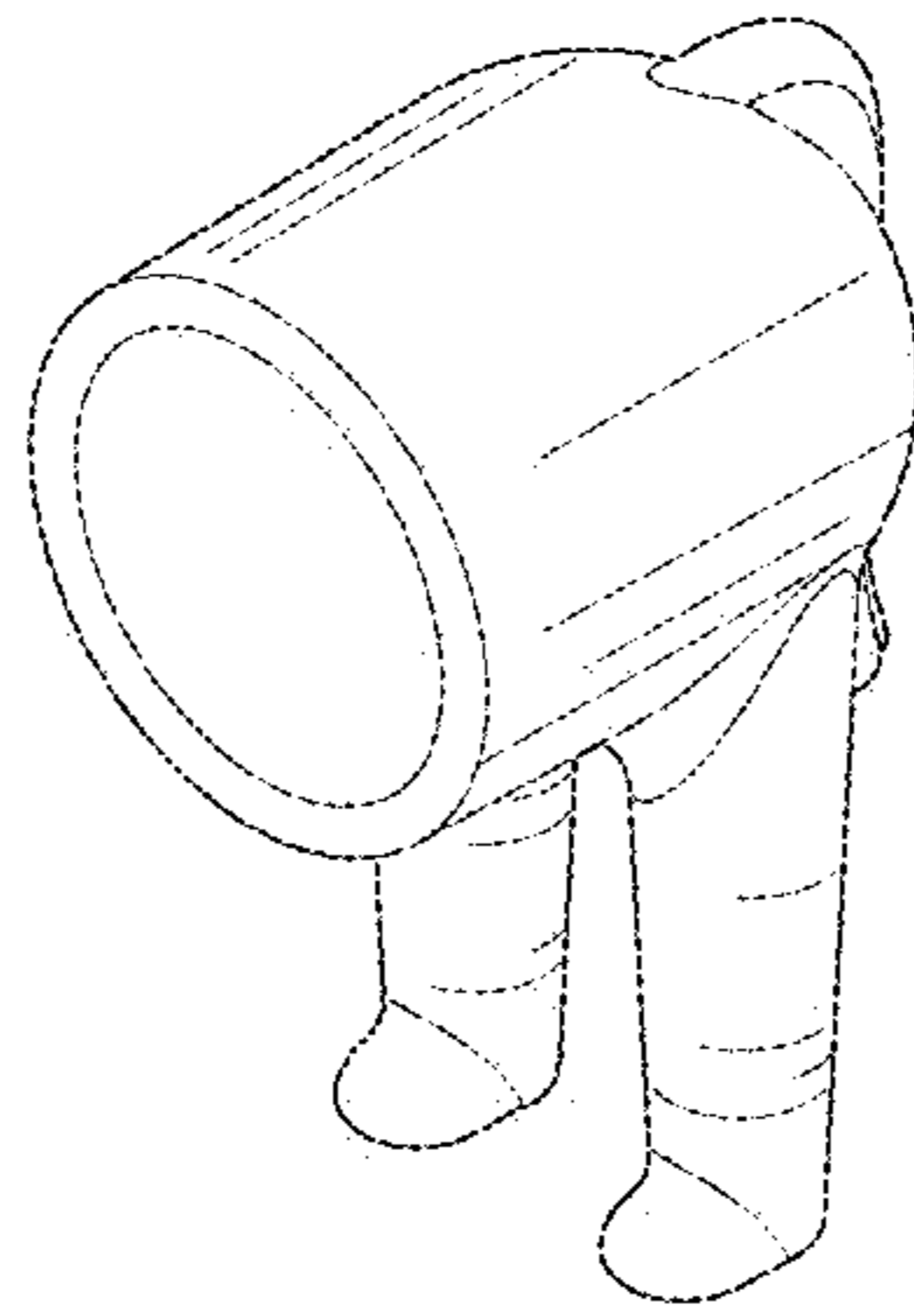

FIG. 68

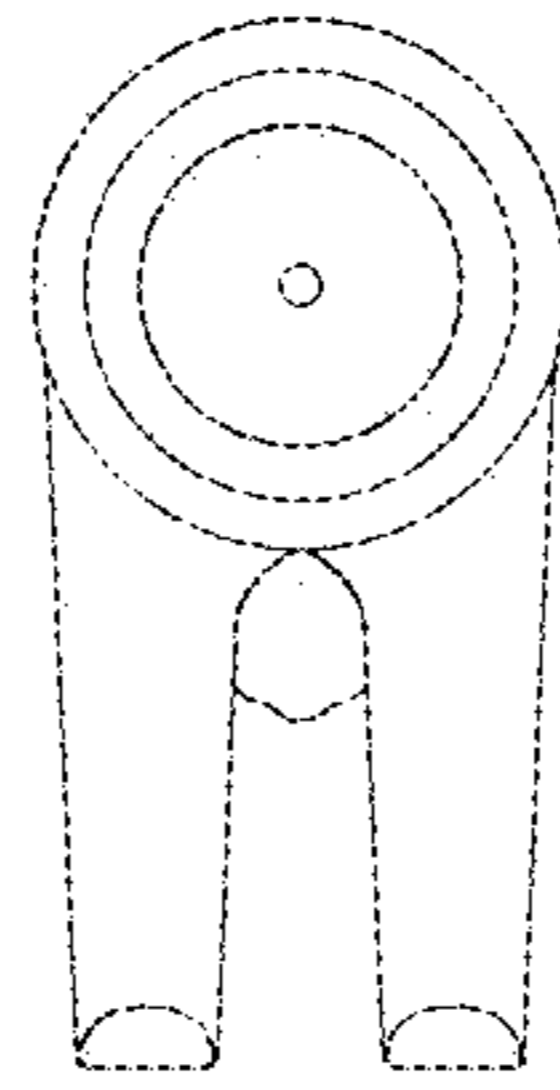

FIG. 69

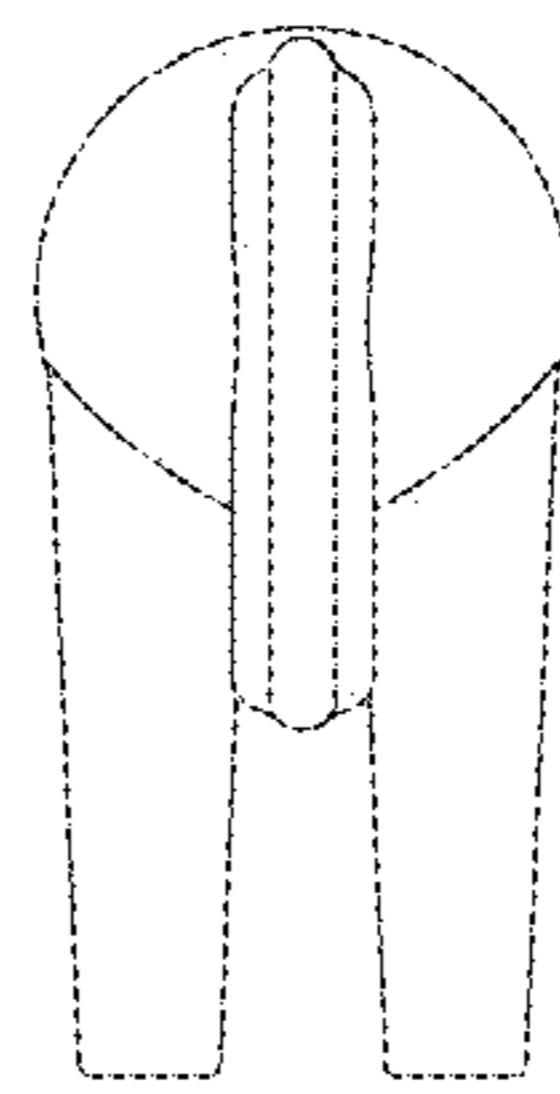

FIG. 70

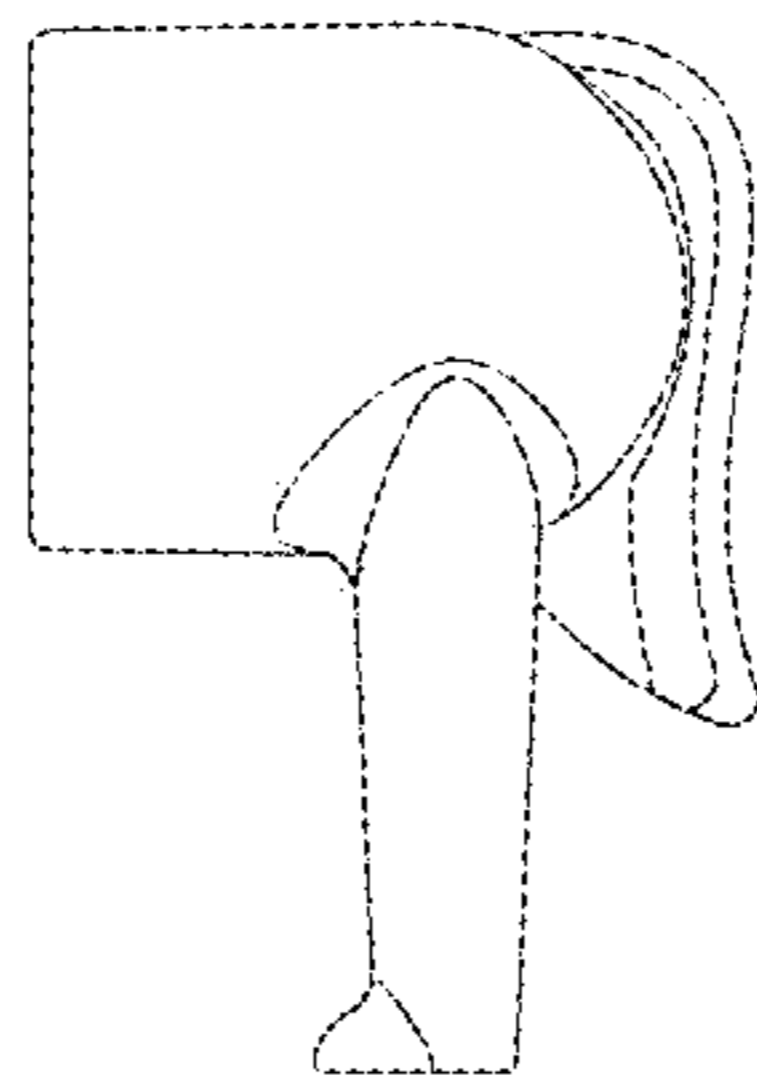

FIG. 71

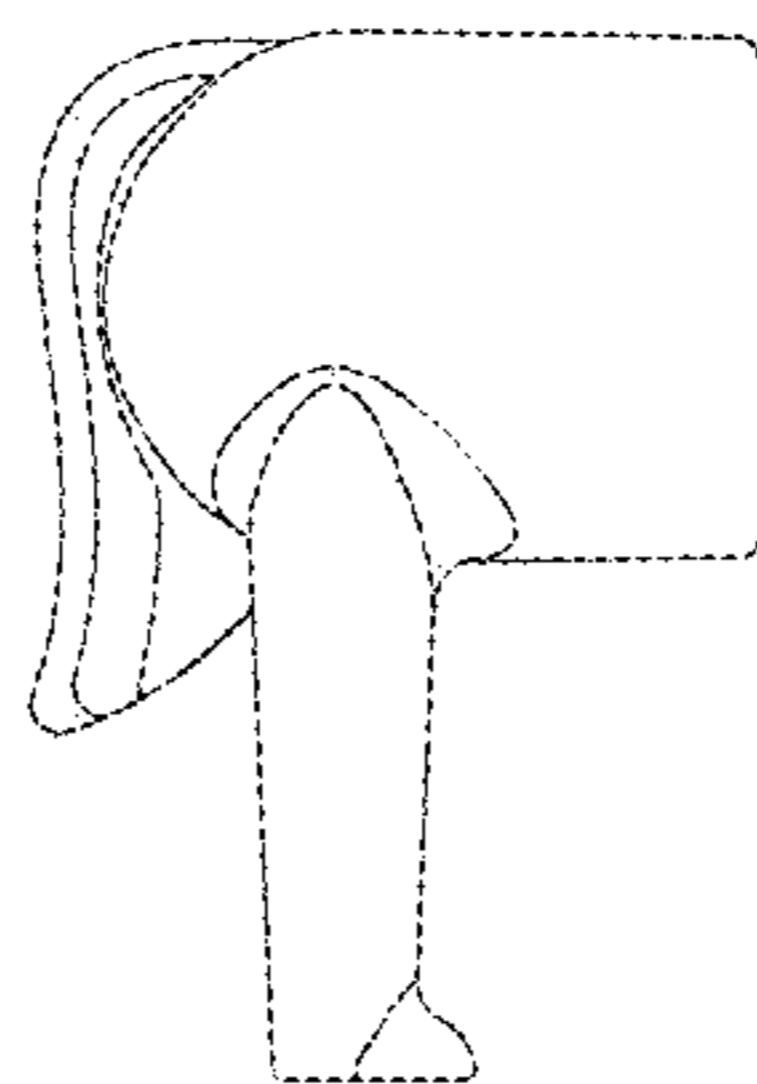

FIG. 72

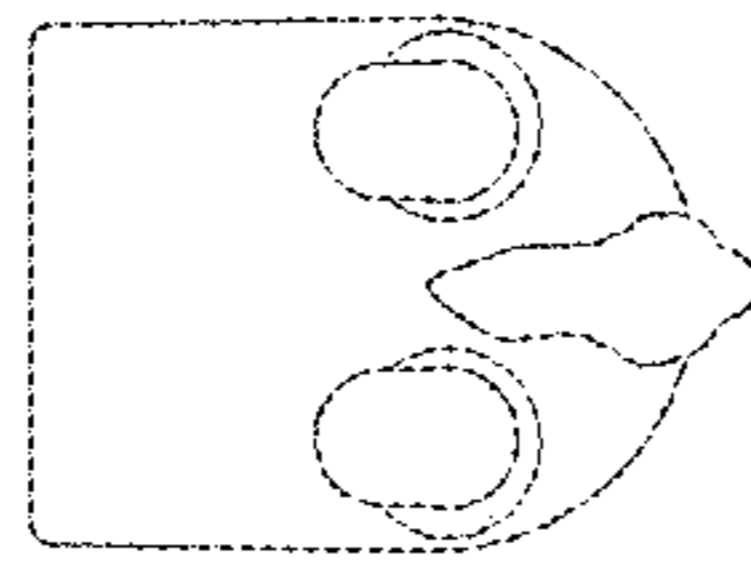

FIG. 73

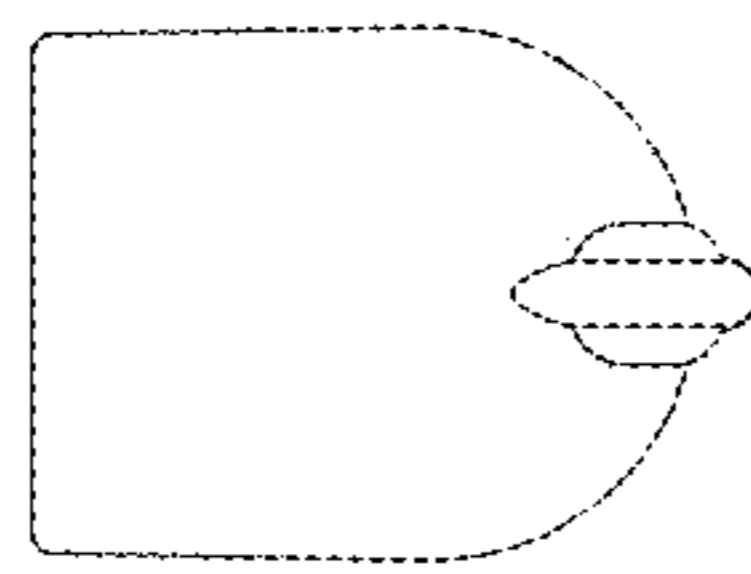

FIG. 74

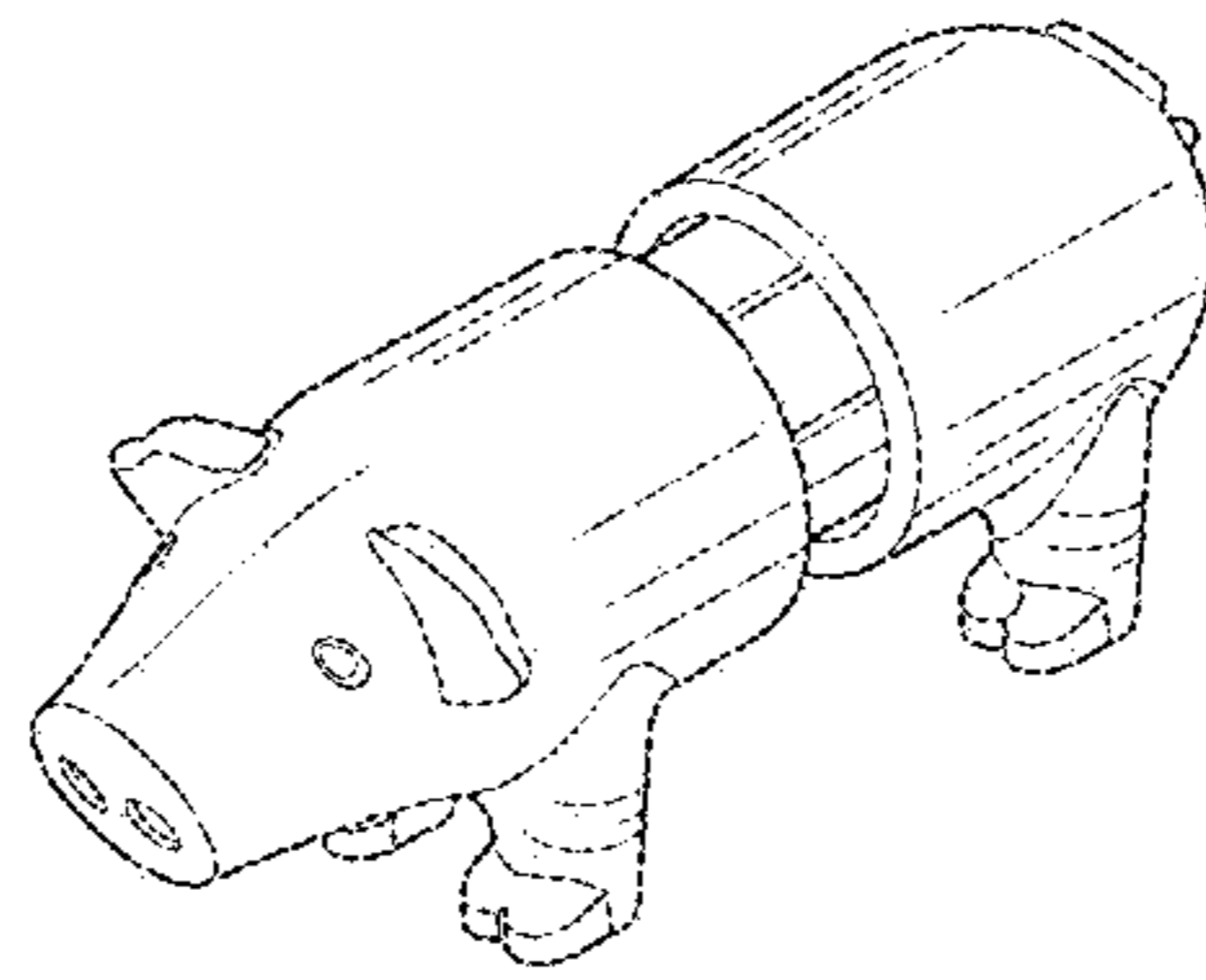

FIG. 75

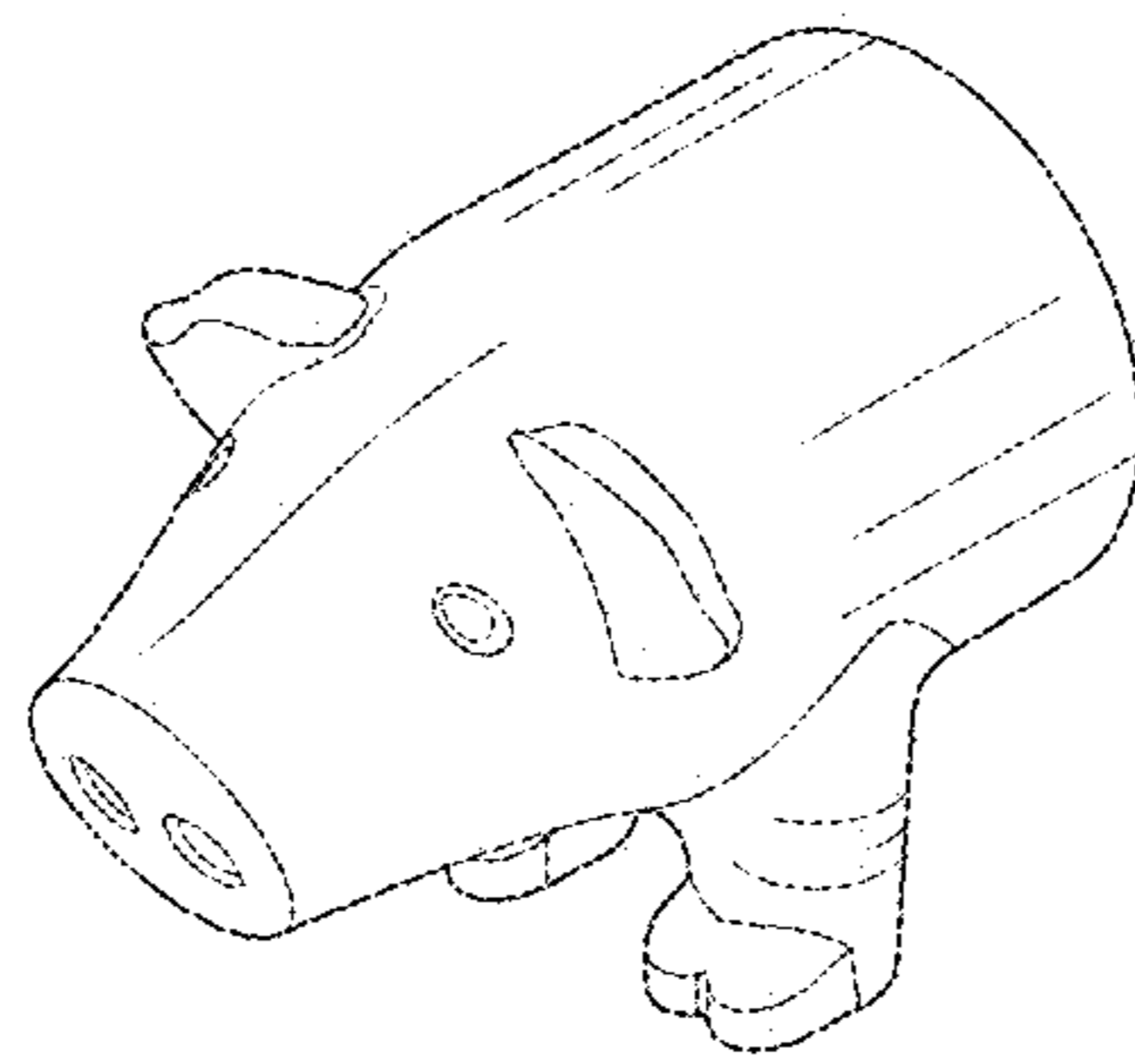

FIG. 76

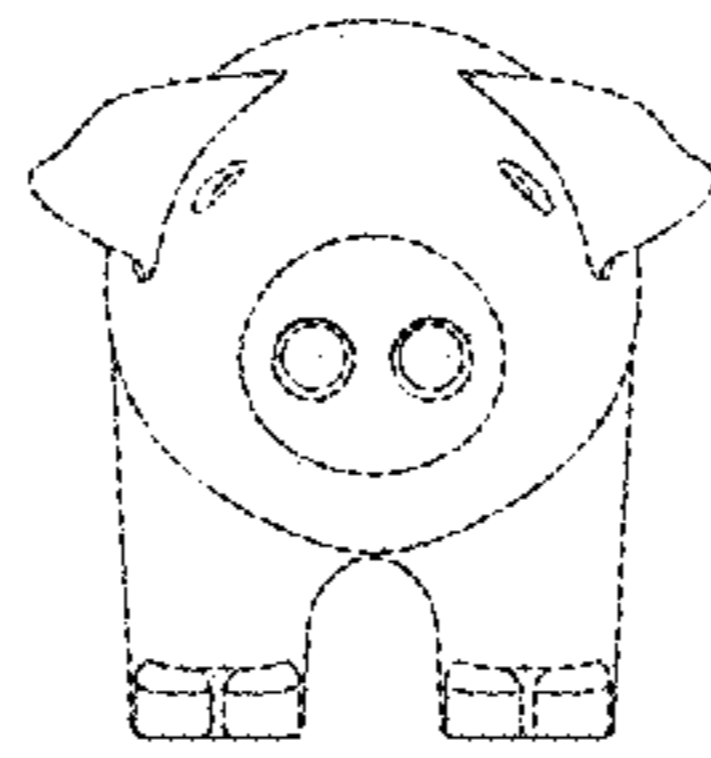

FIG. 77

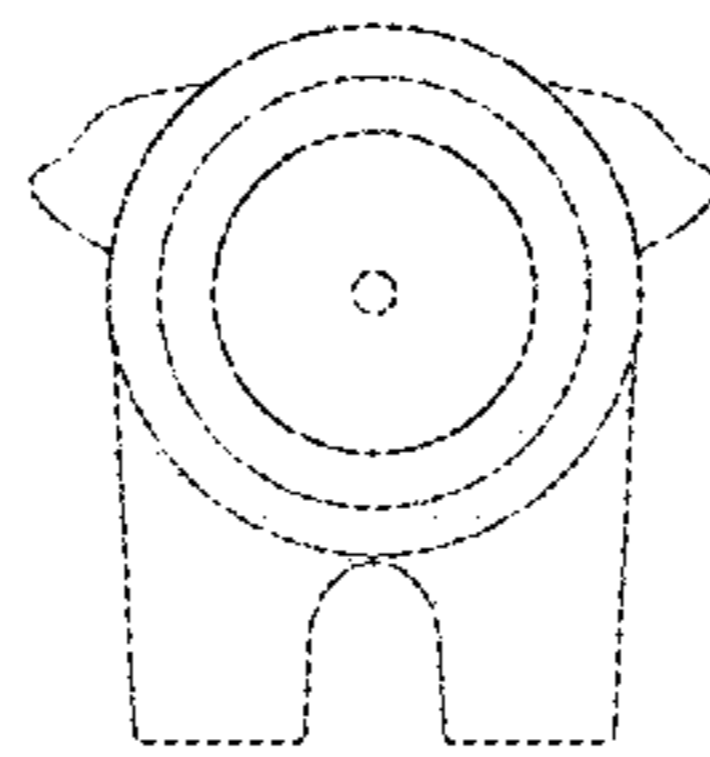

FIG. 78

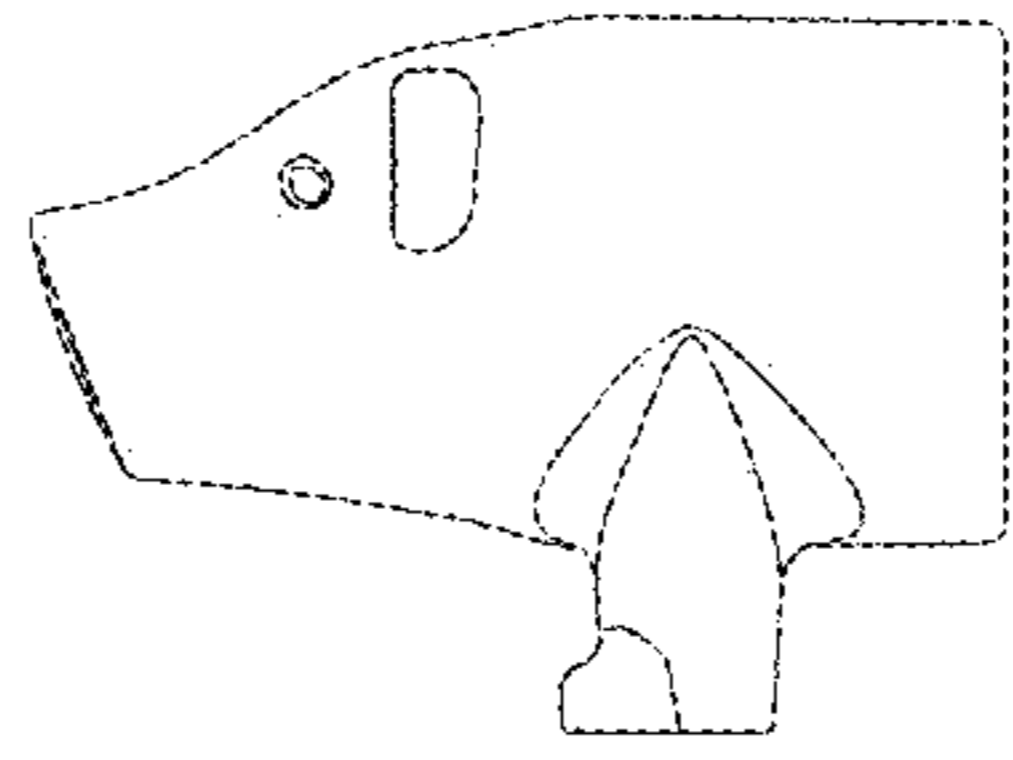

FIG. 79

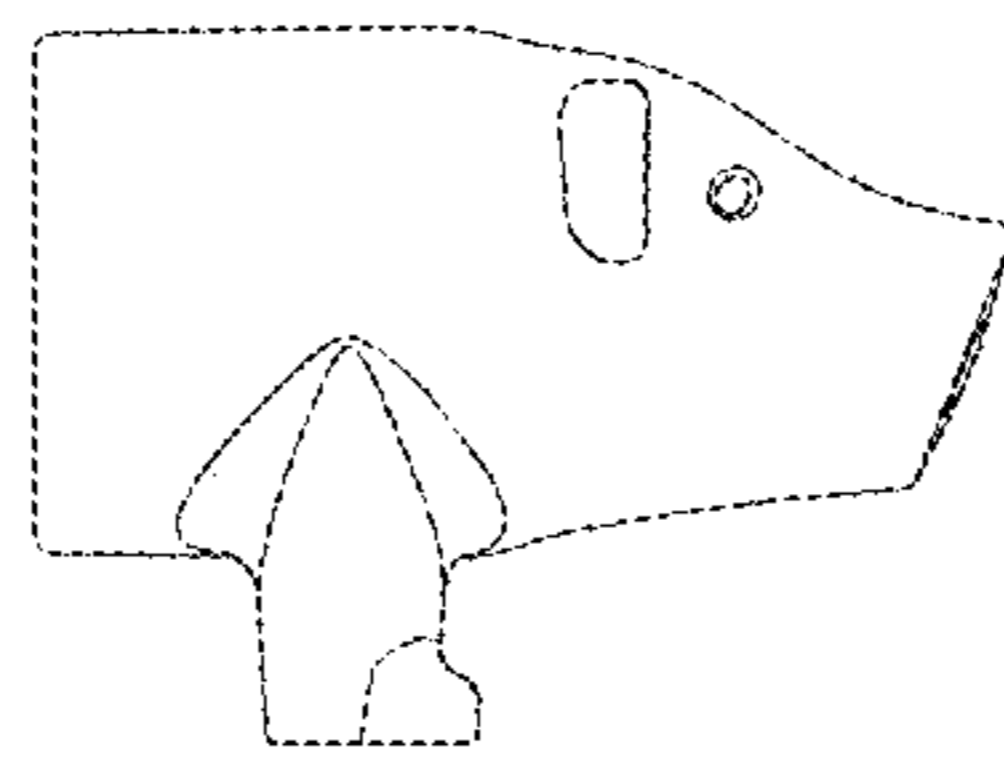

FIG. 80

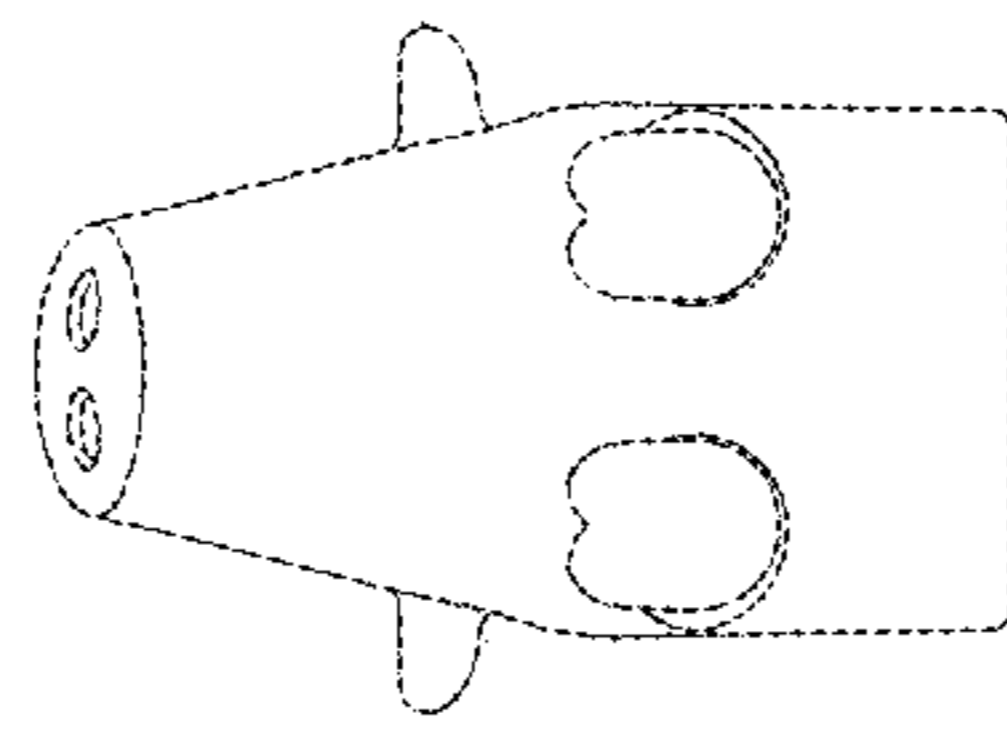

FIG. 81

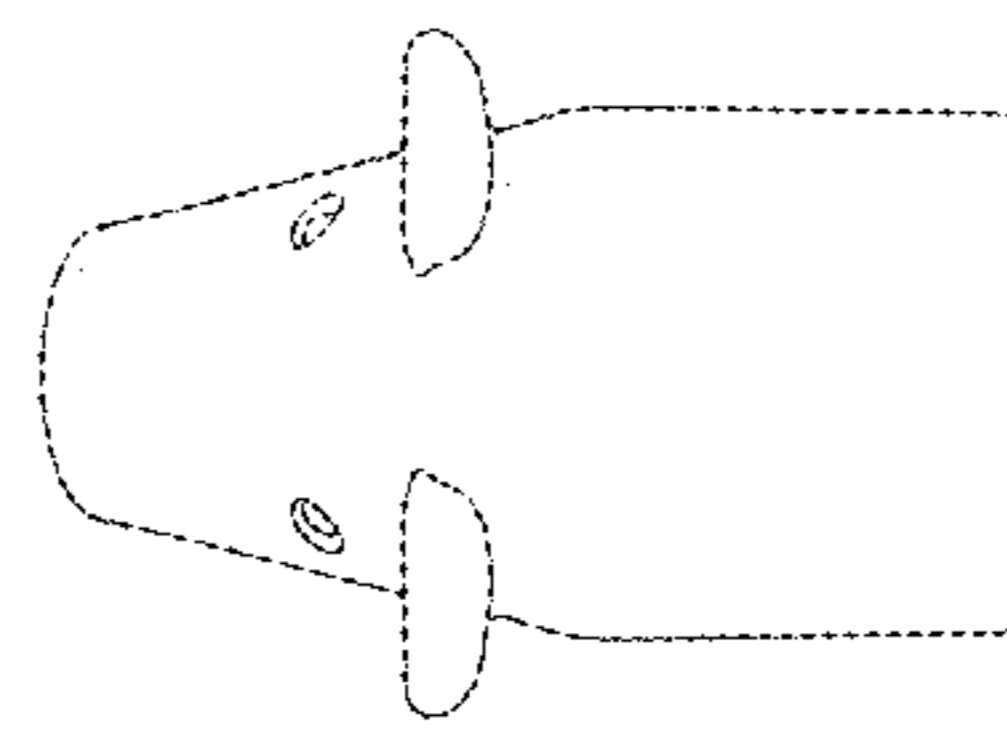

FIG. 82

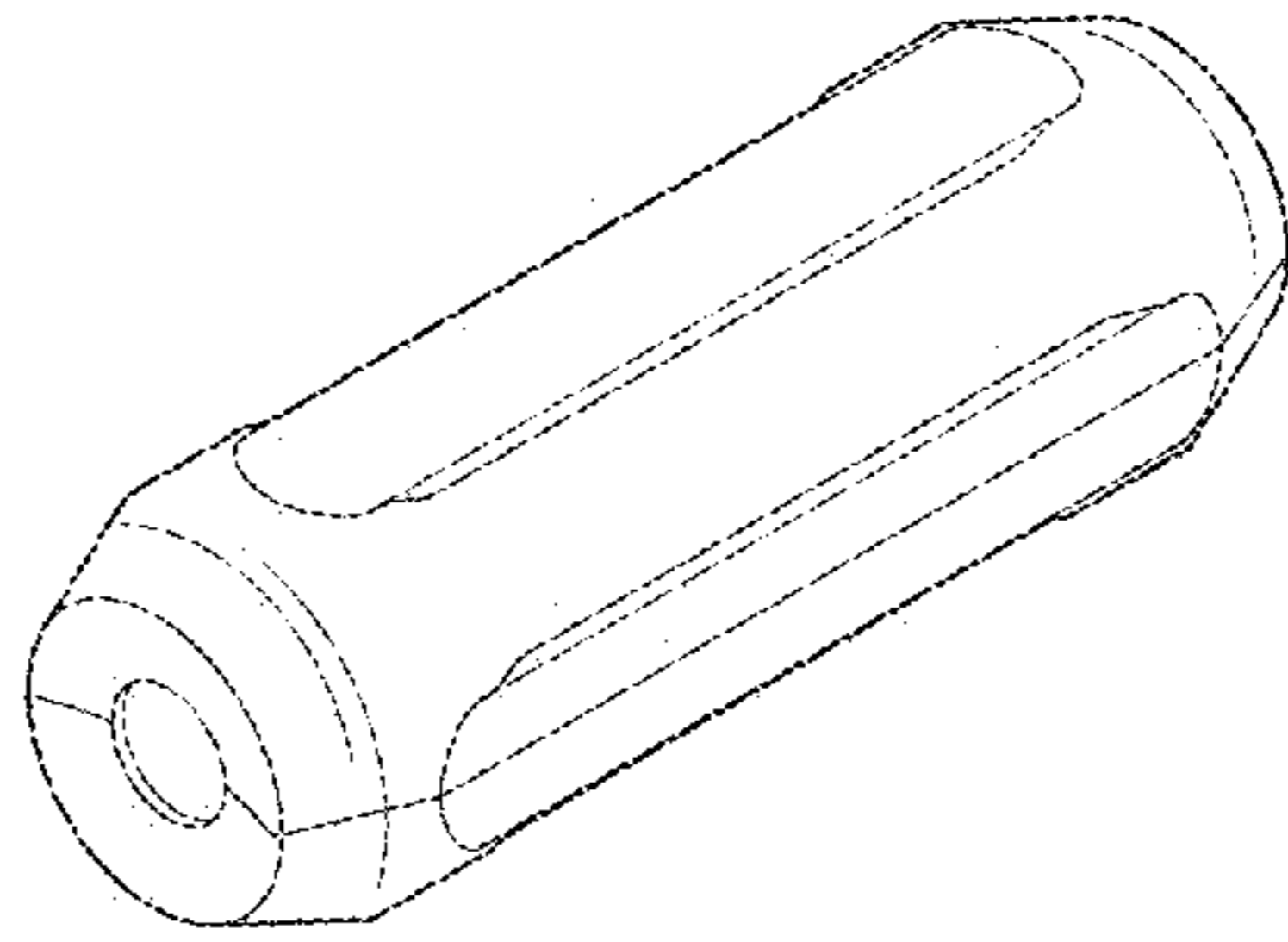

FIG. 83

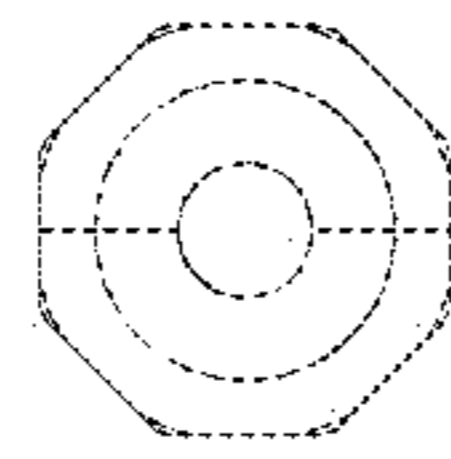

FIG. 84

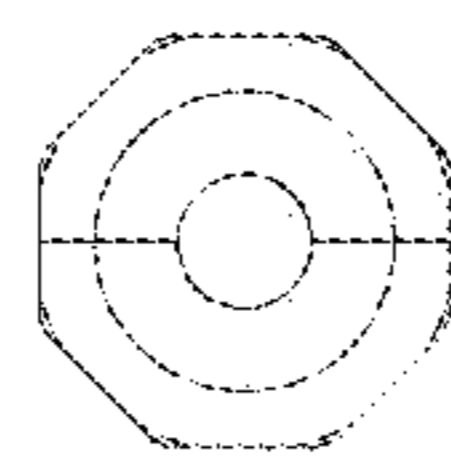

FIG. 85

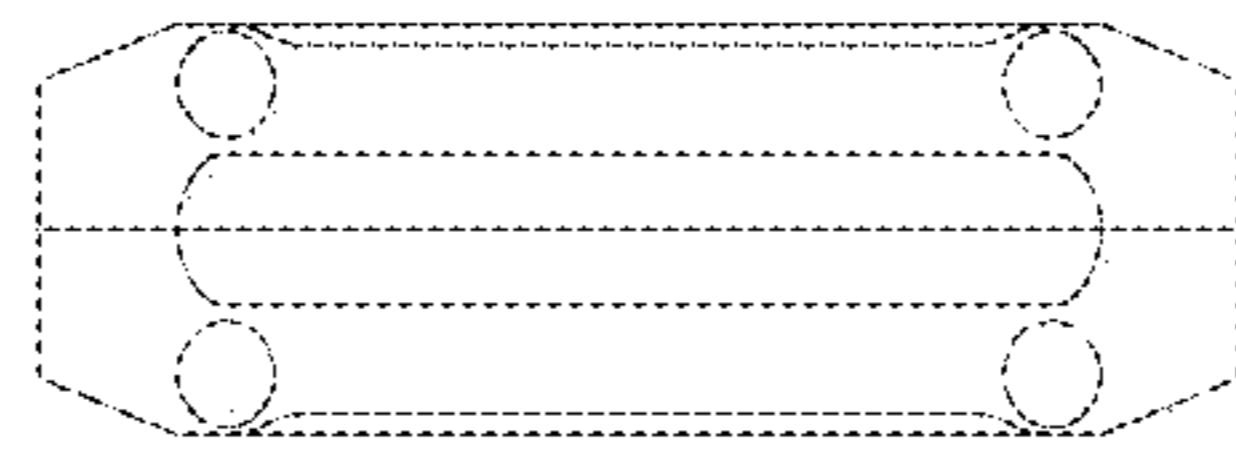

FIG. 86

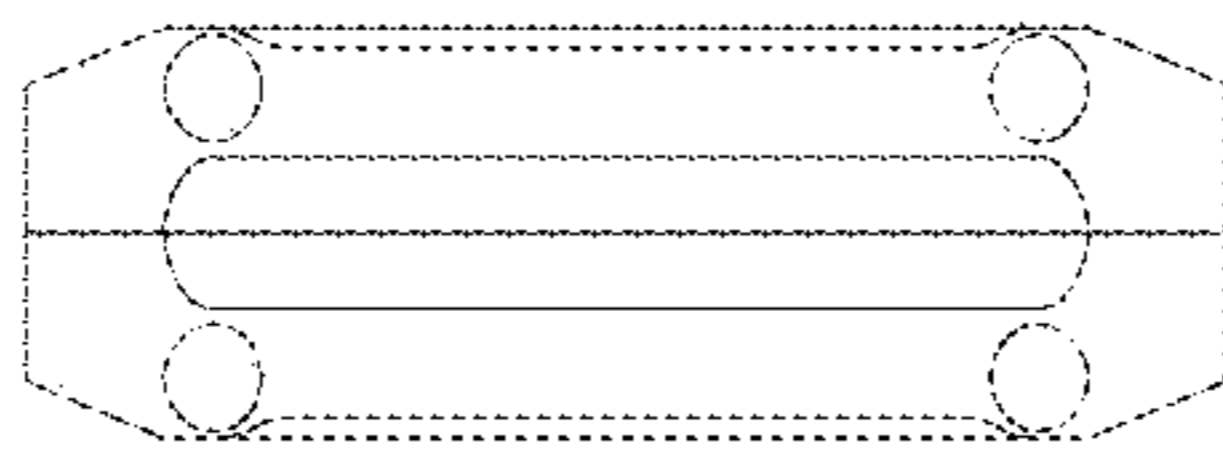

FIG. 87

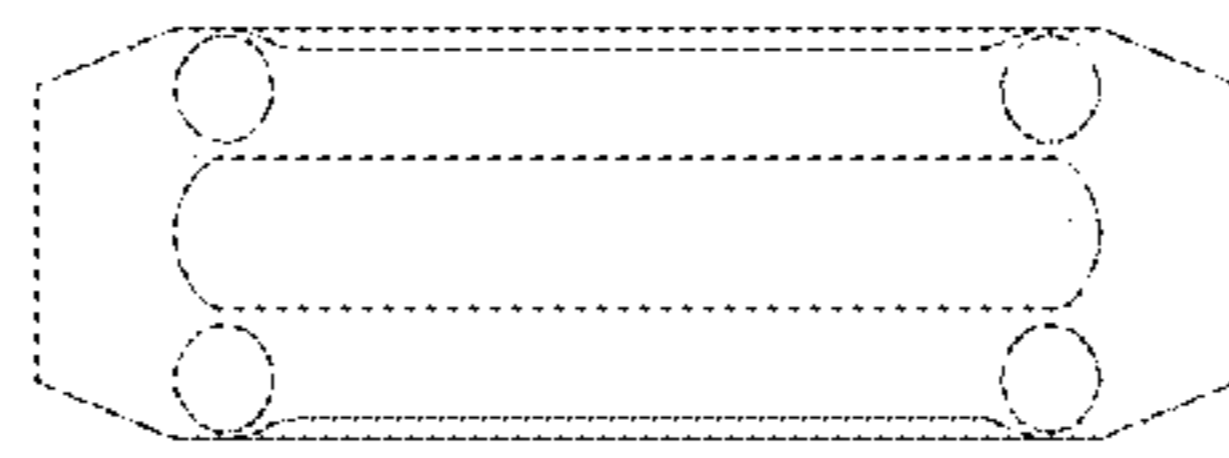

FIG. 88

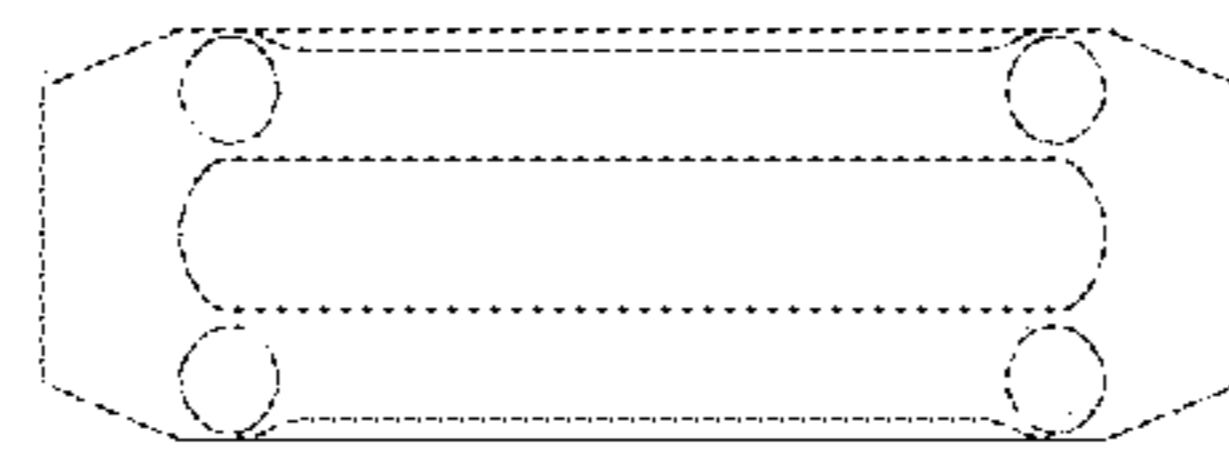

FIG. 89

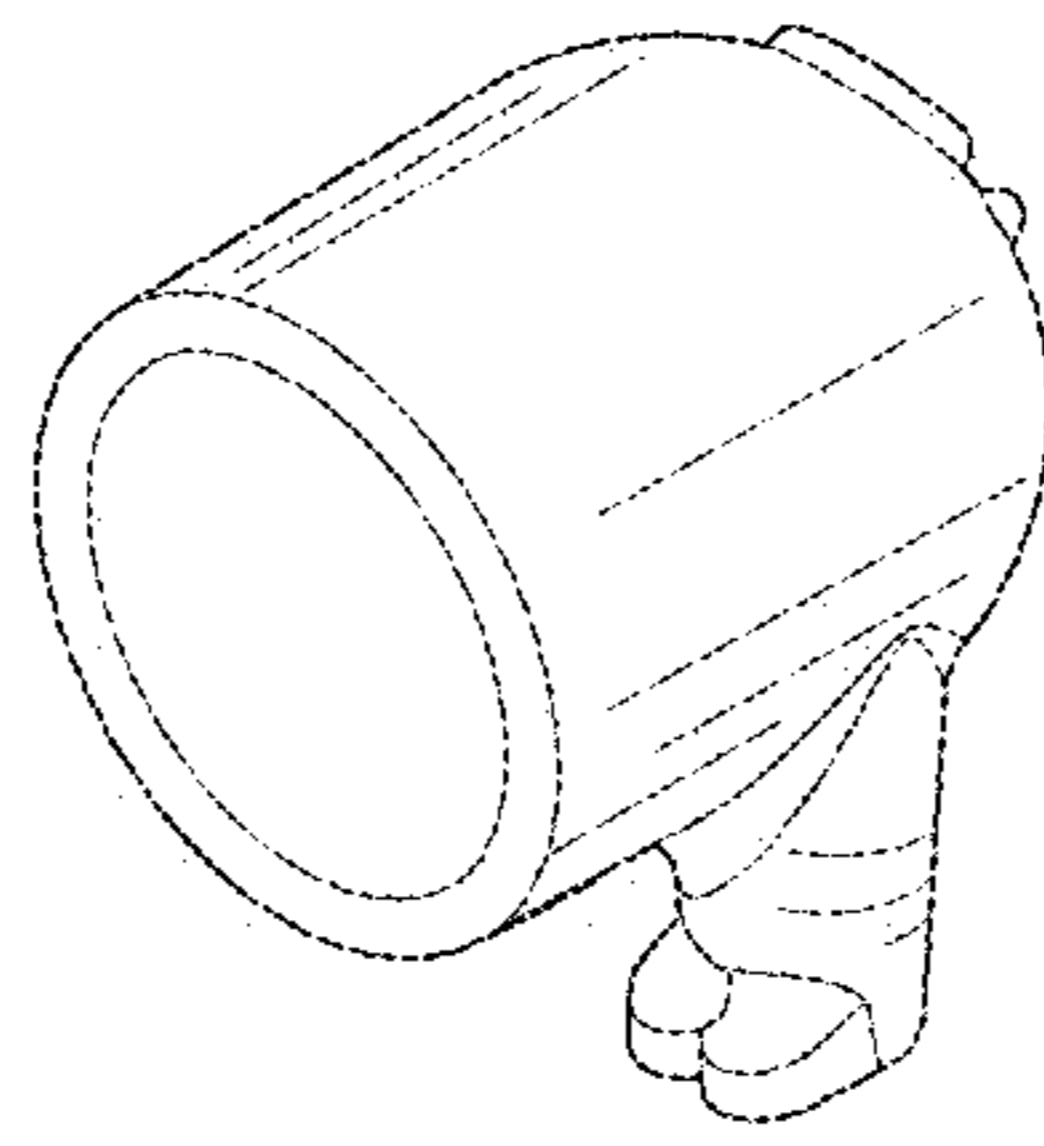

FIG. 90

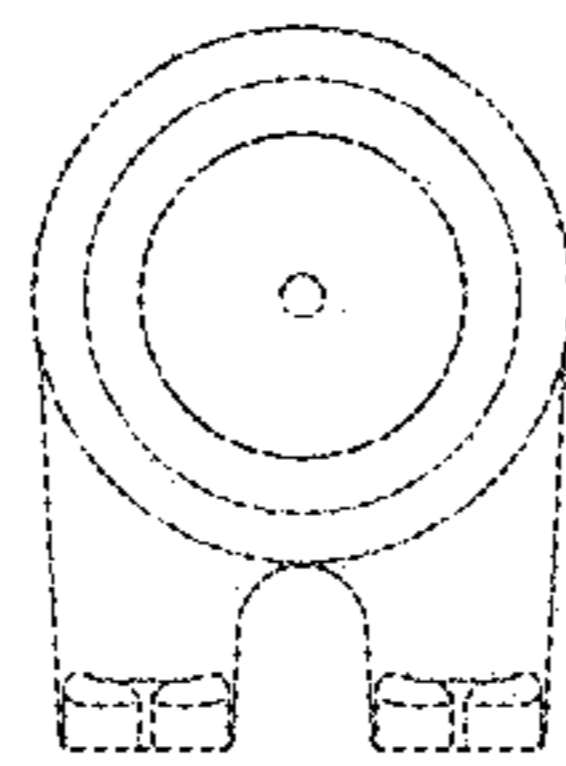

FIG. 91

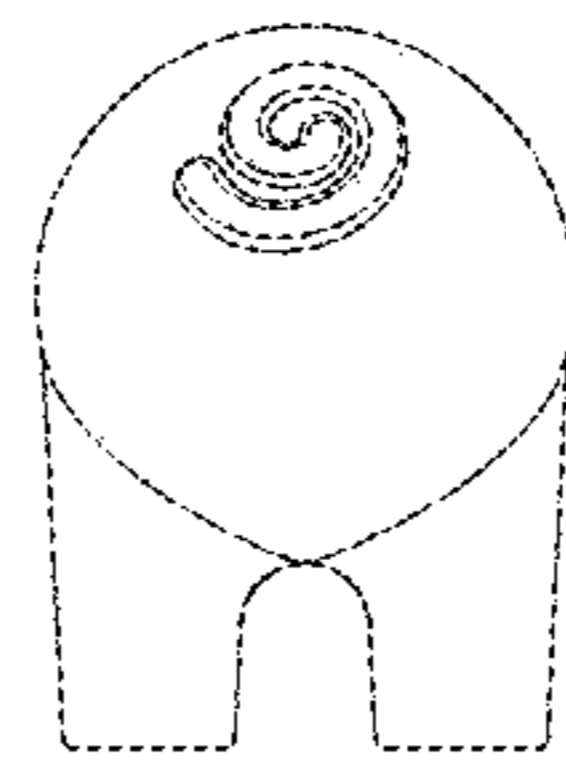

FIG. 92

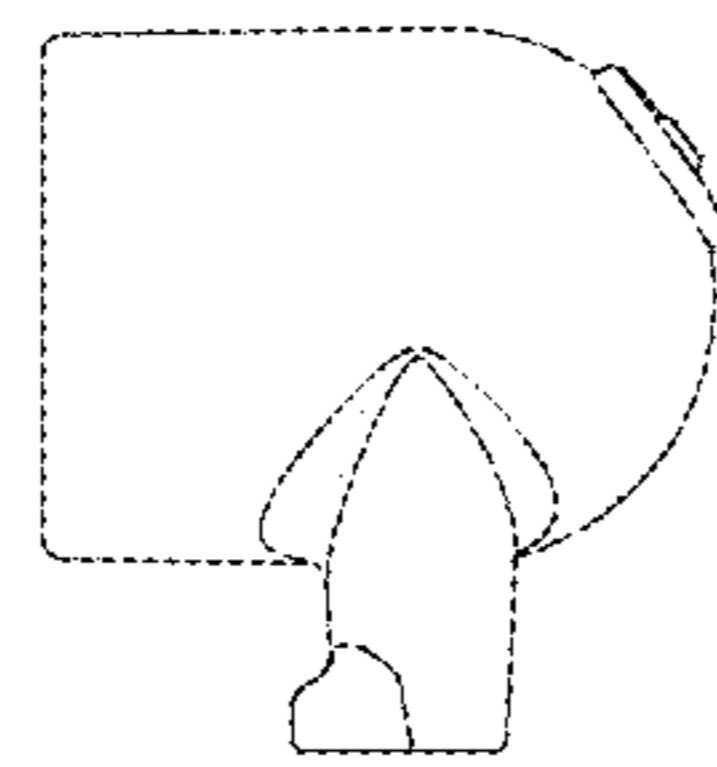

FIG. 93

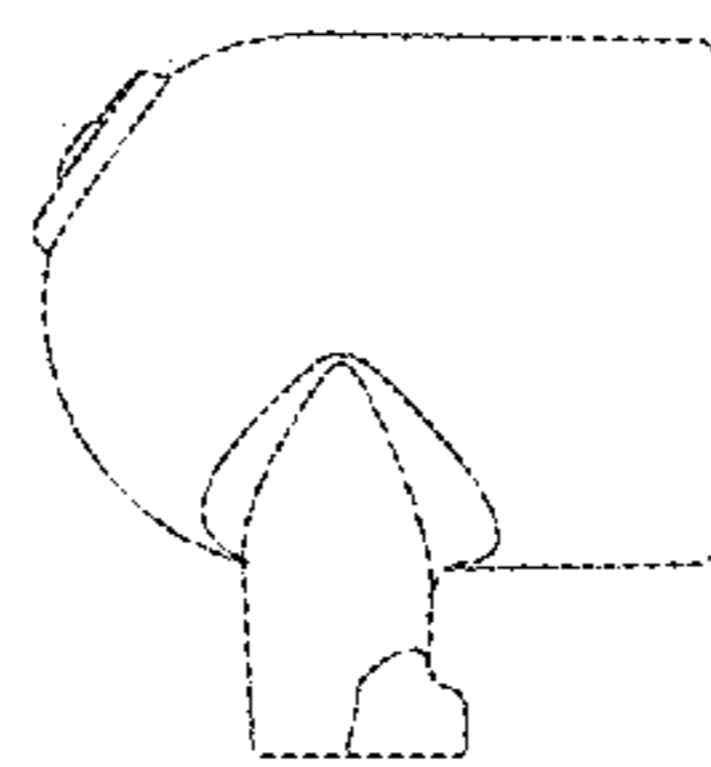

FIG. 94

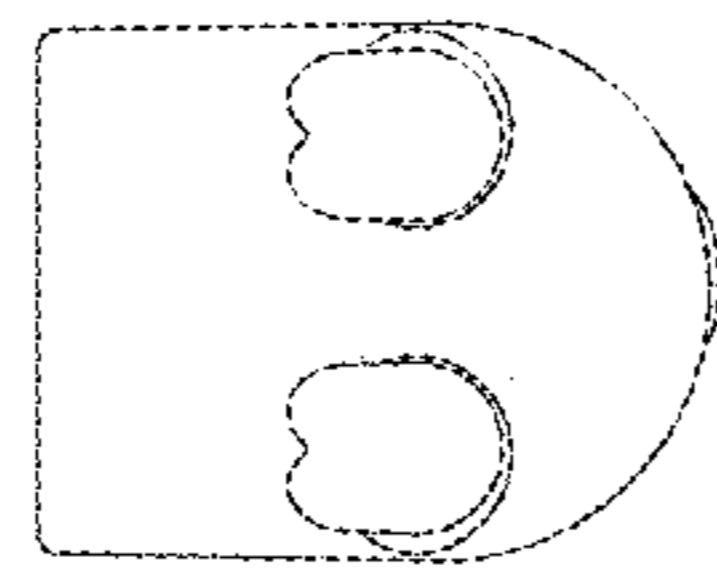

FIG. 95

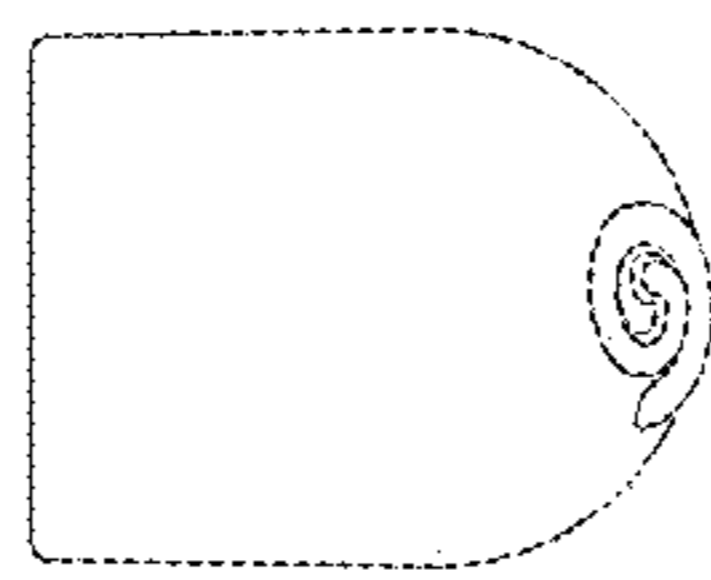

FIG. 96

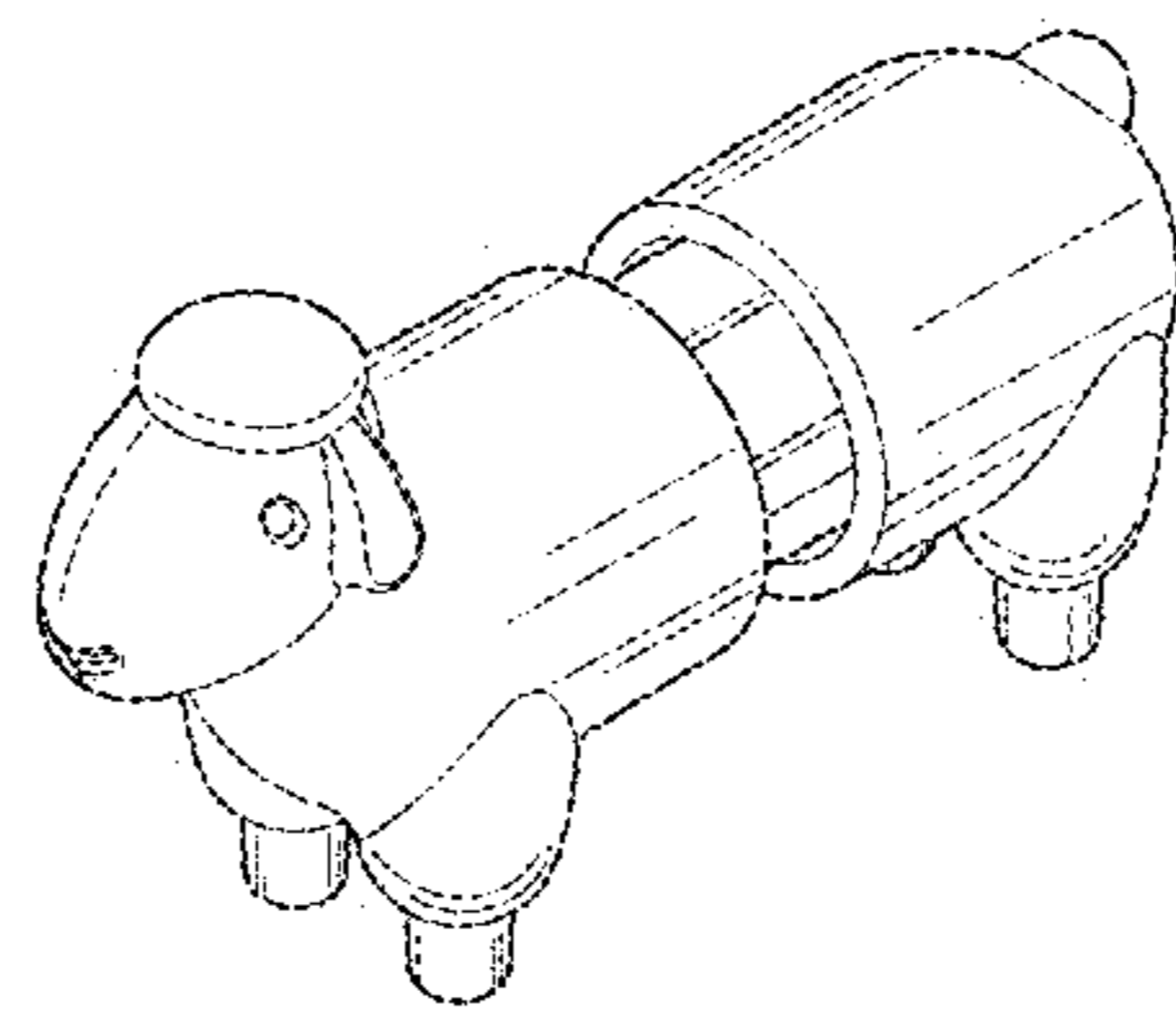

FIG. 97

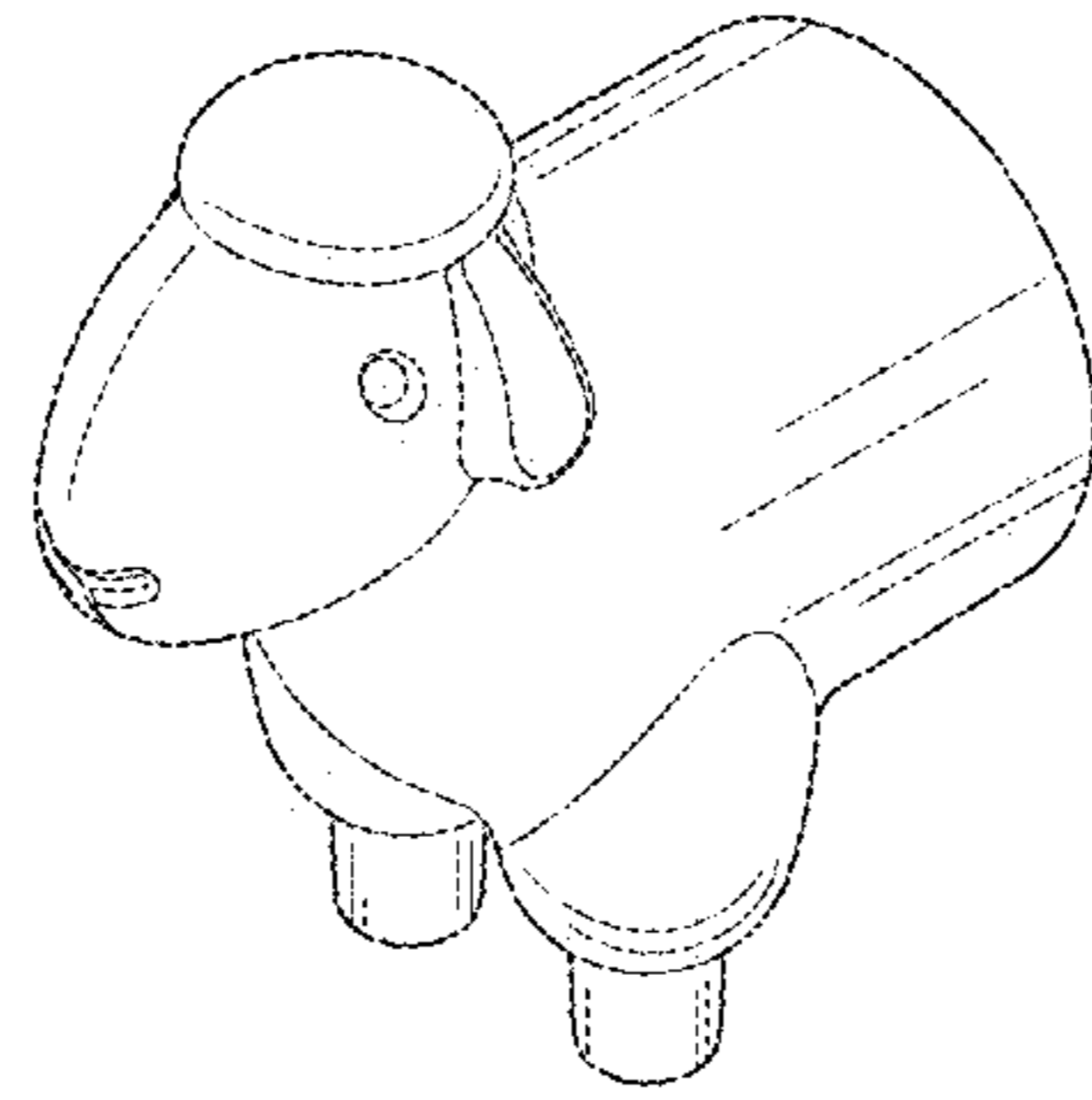

FIG. 98

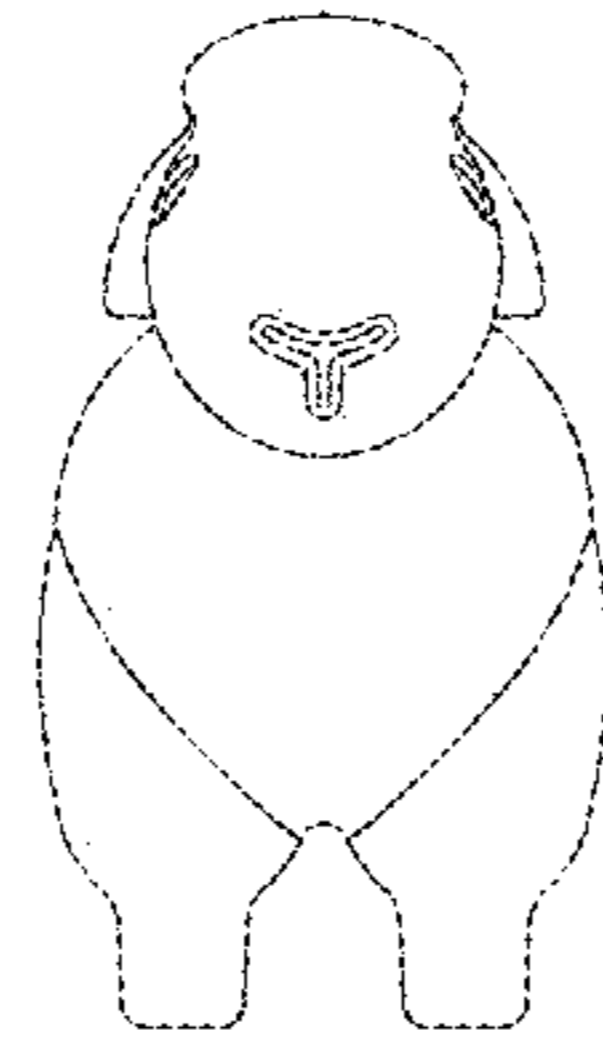

FIG. 99

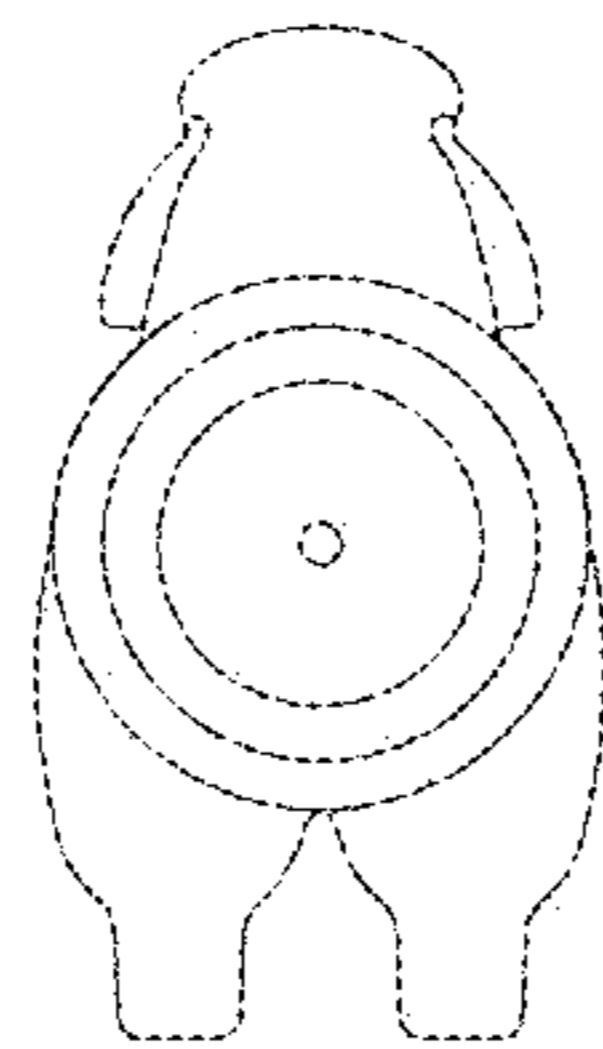

FIG. 100

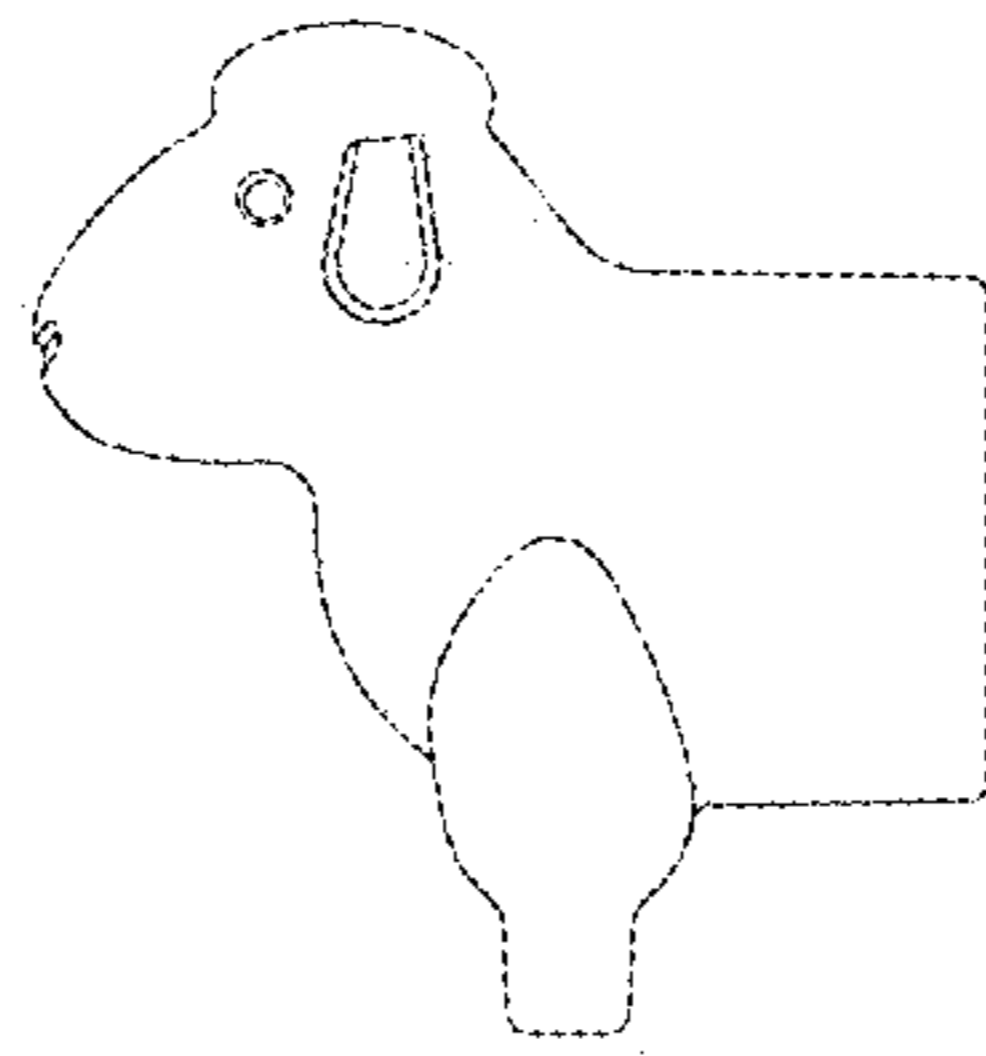

FIG. 101

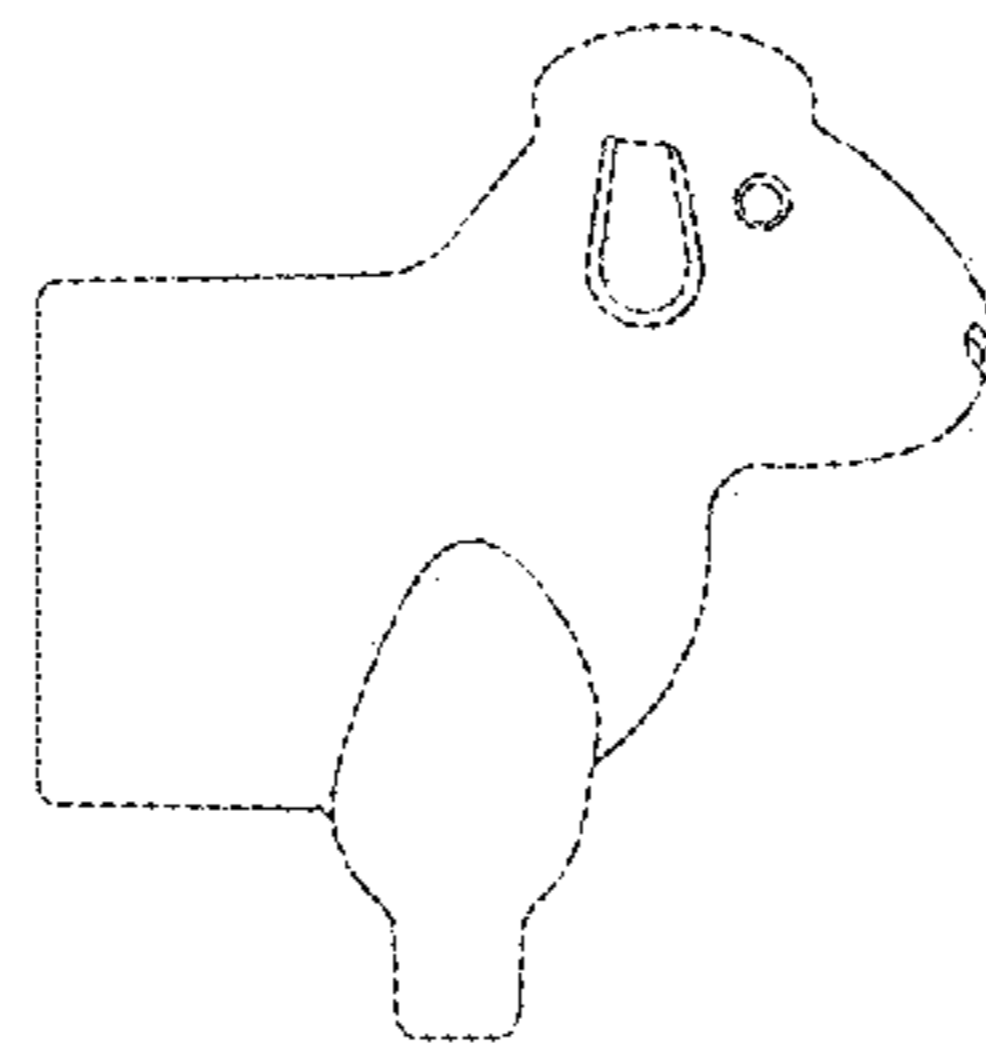

FIG. 102

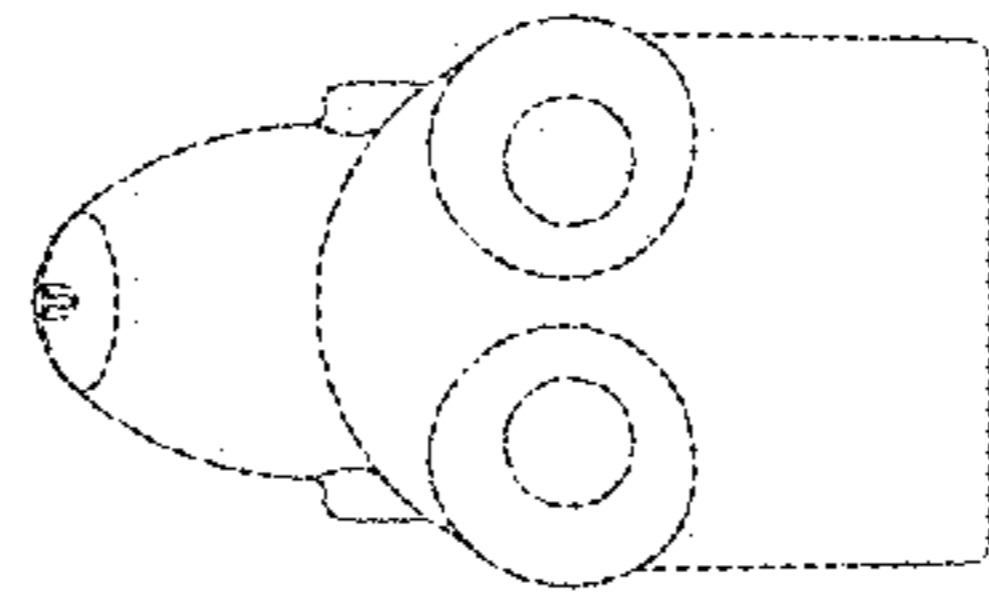

FIG. 103

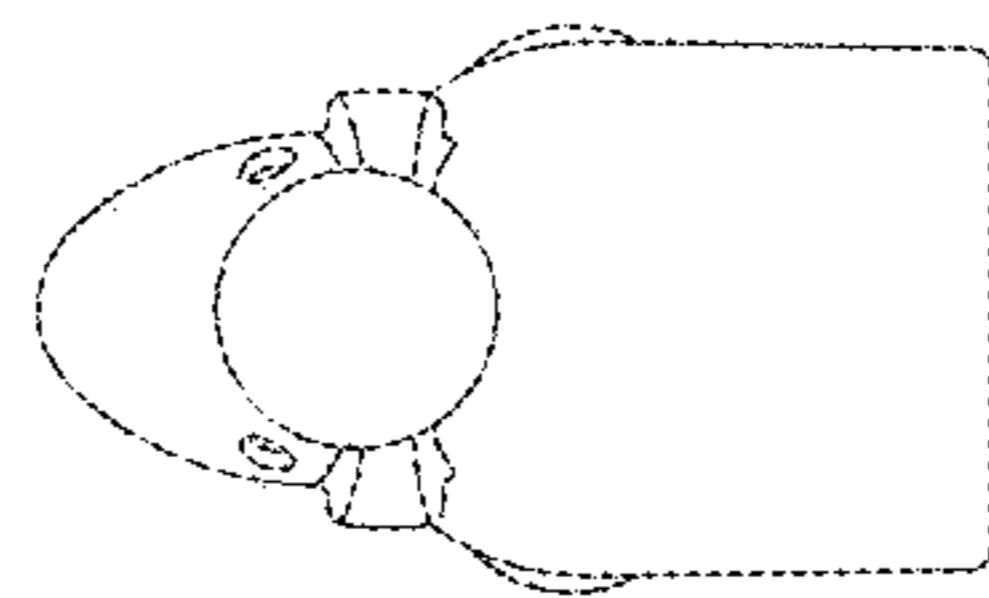

FIG. 104

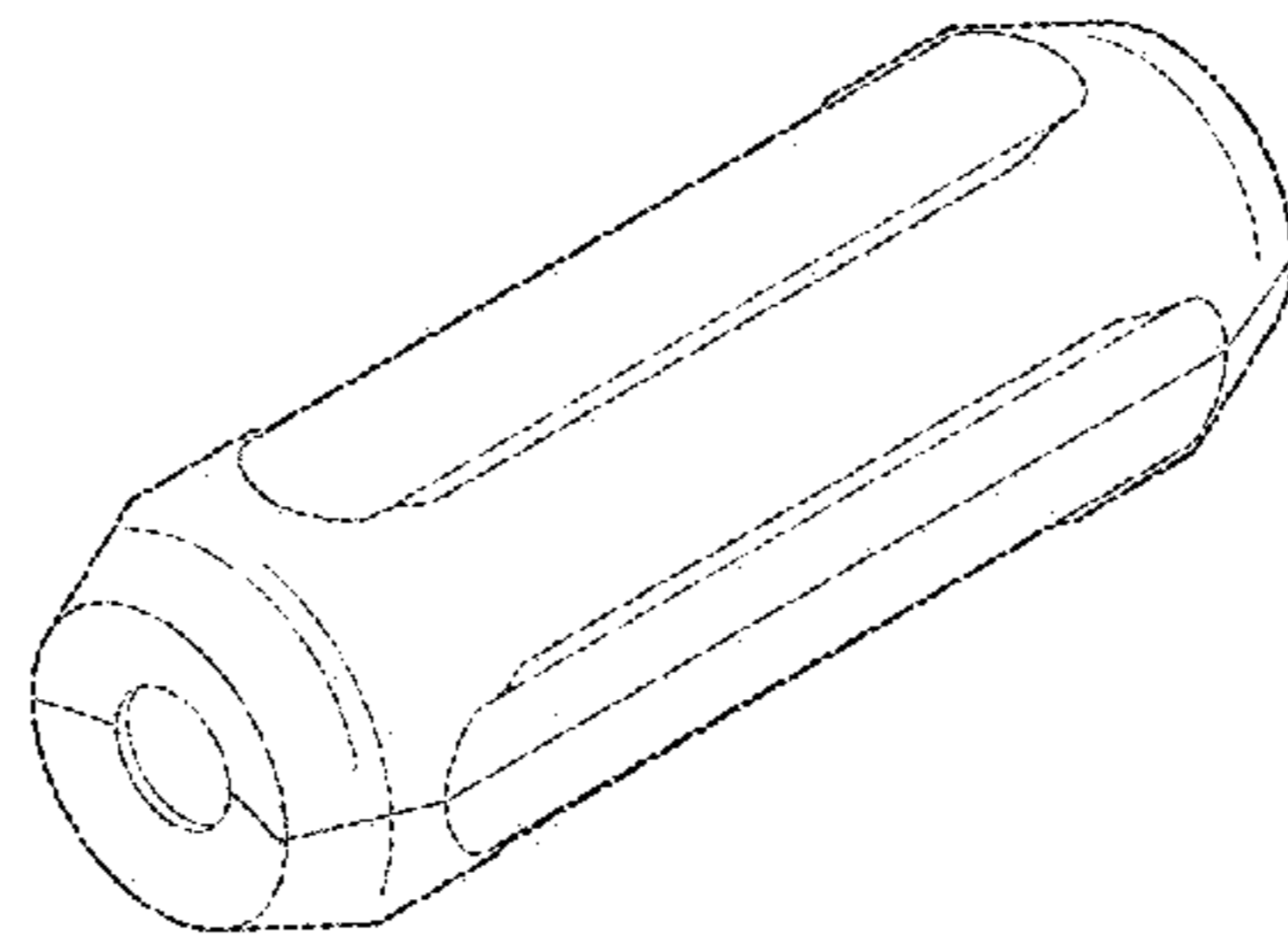

FIG. 105

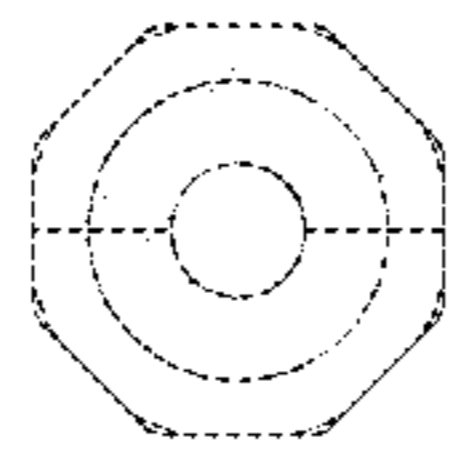

FIG. 106

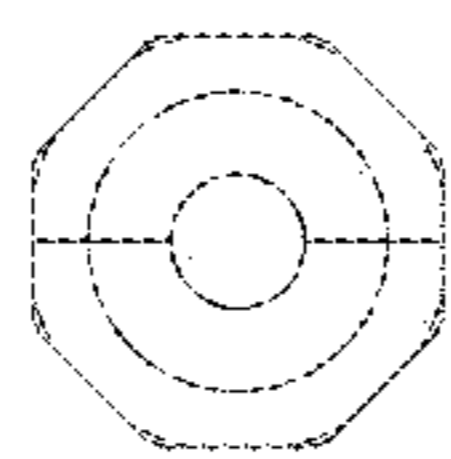

FIG. 107

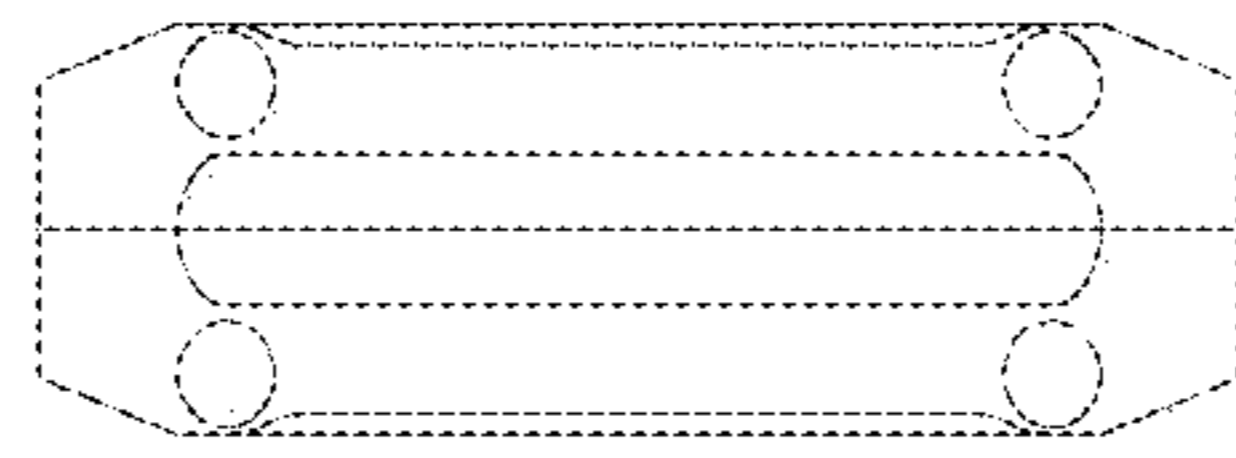

FIG. 108

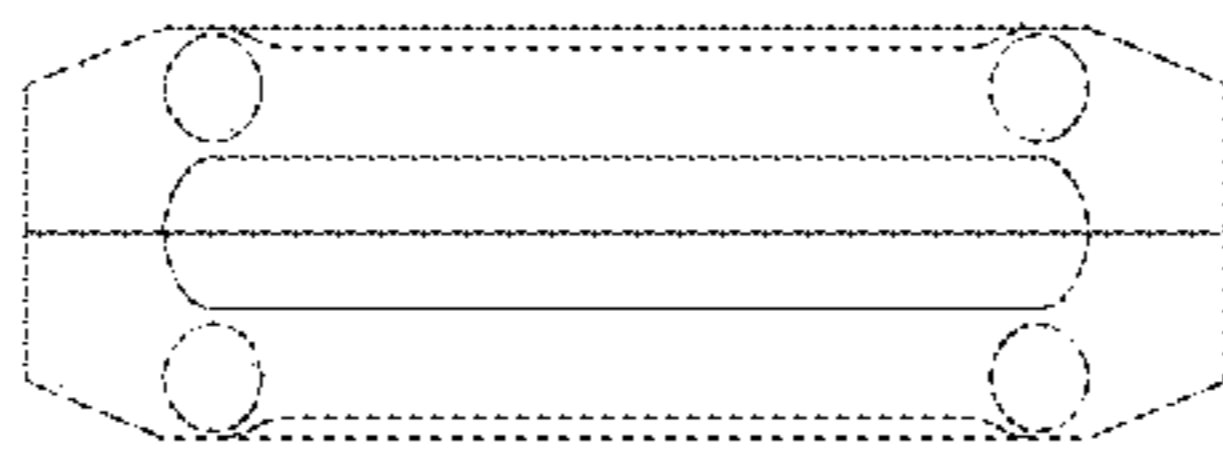

FIG. 109

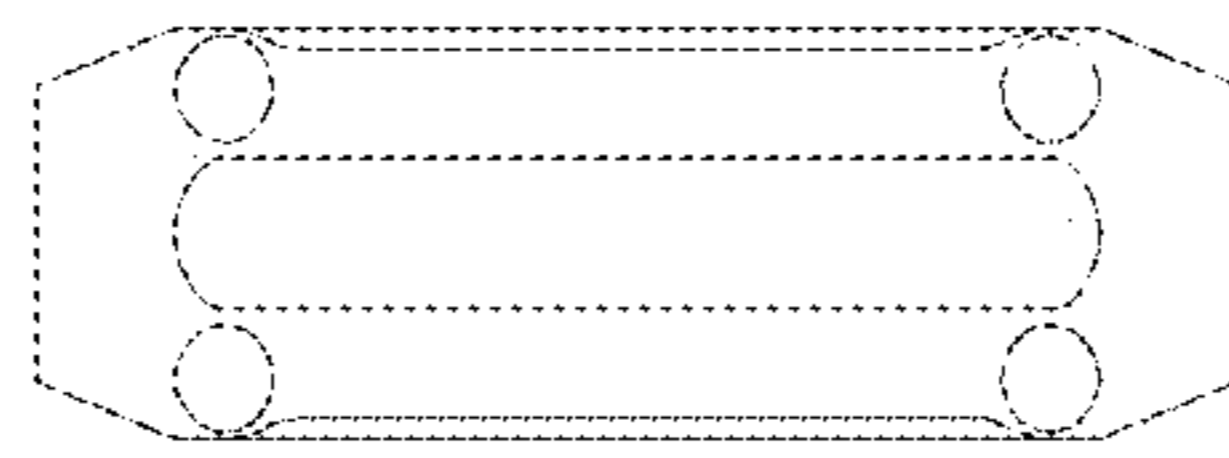

FIG. 110

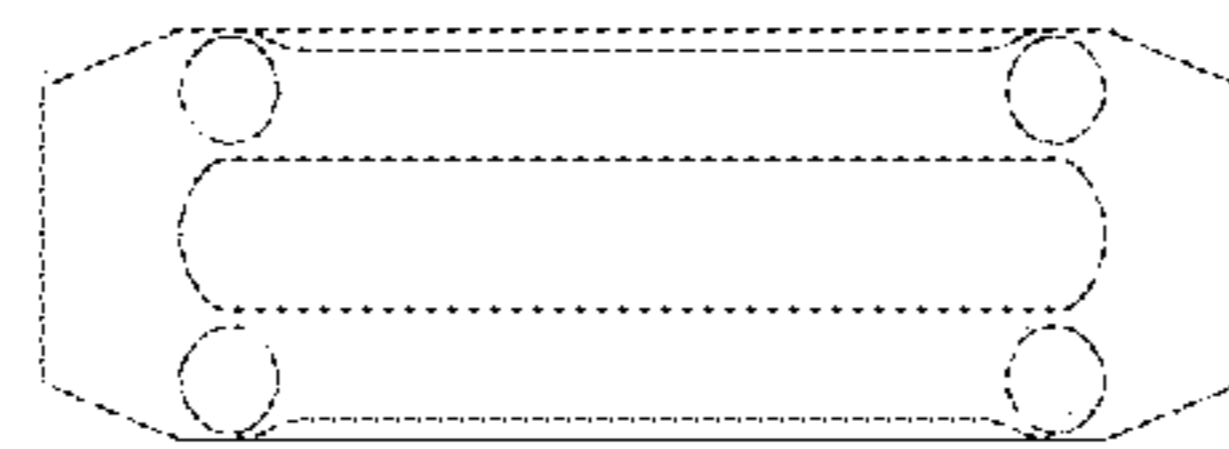

FIG. 111

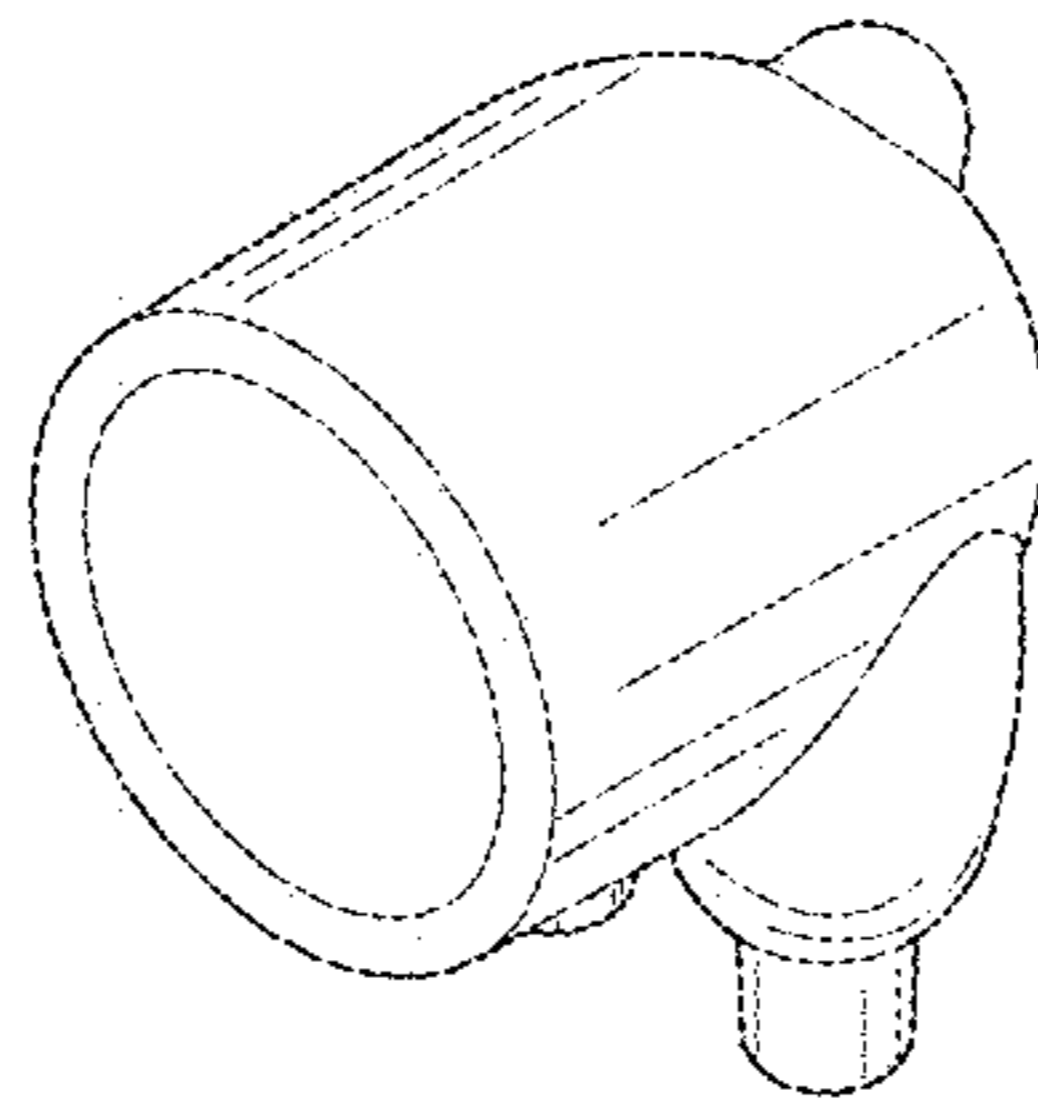

FIG. 112

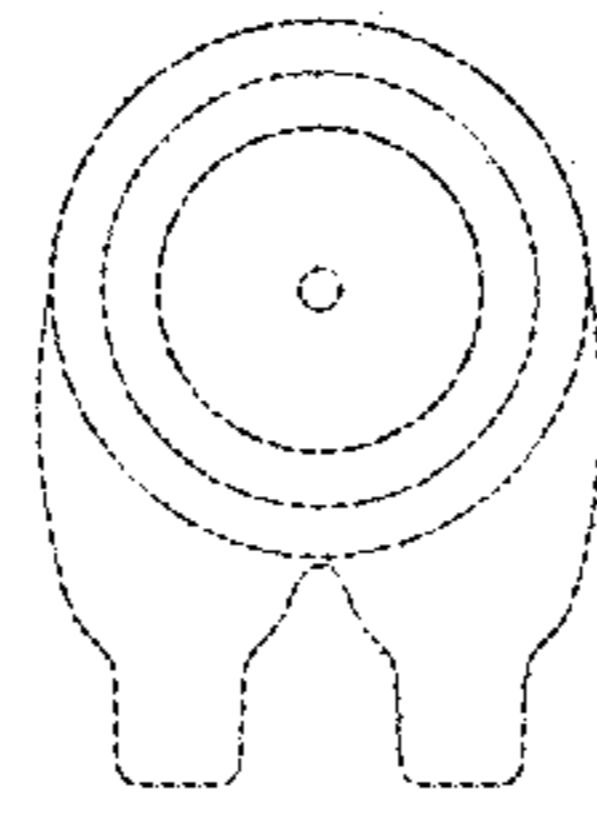

FIG. 113

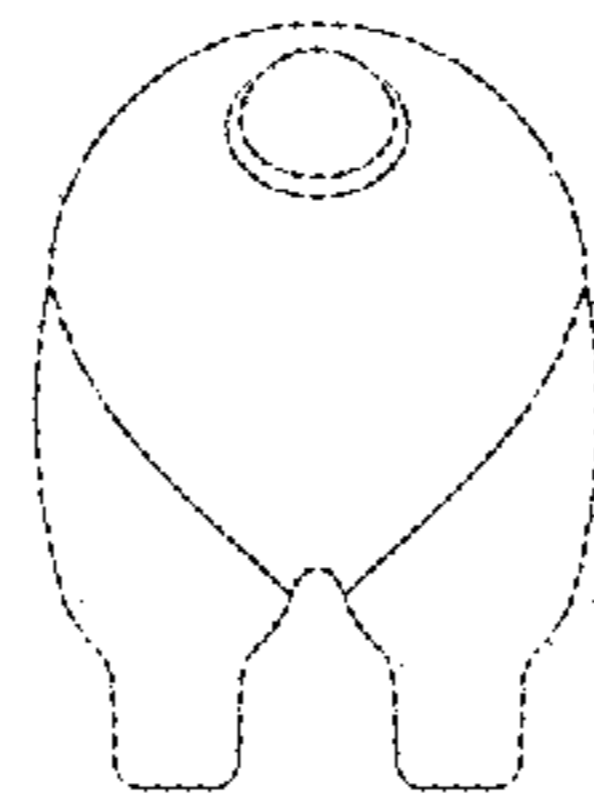

FIG. 114

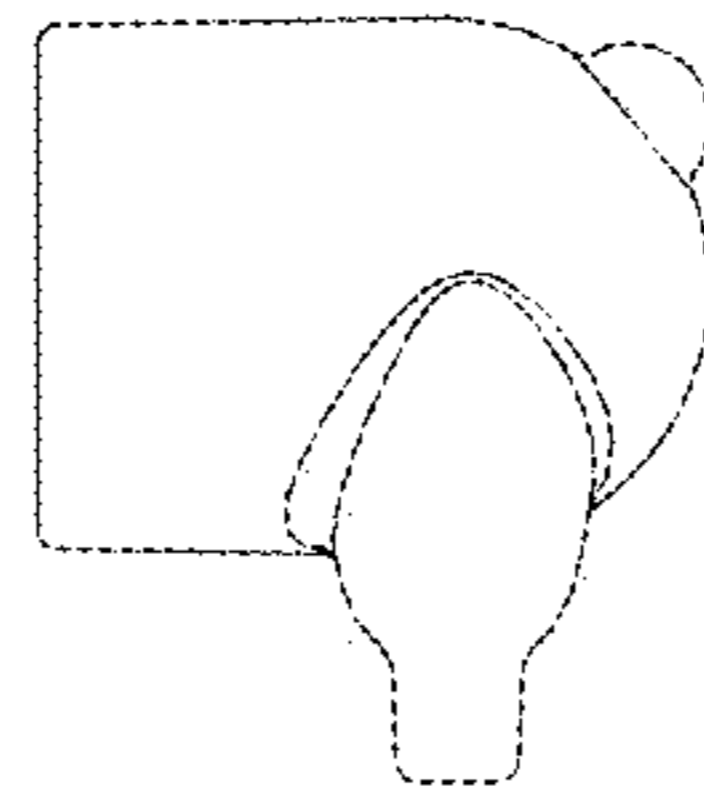

FIG. 115

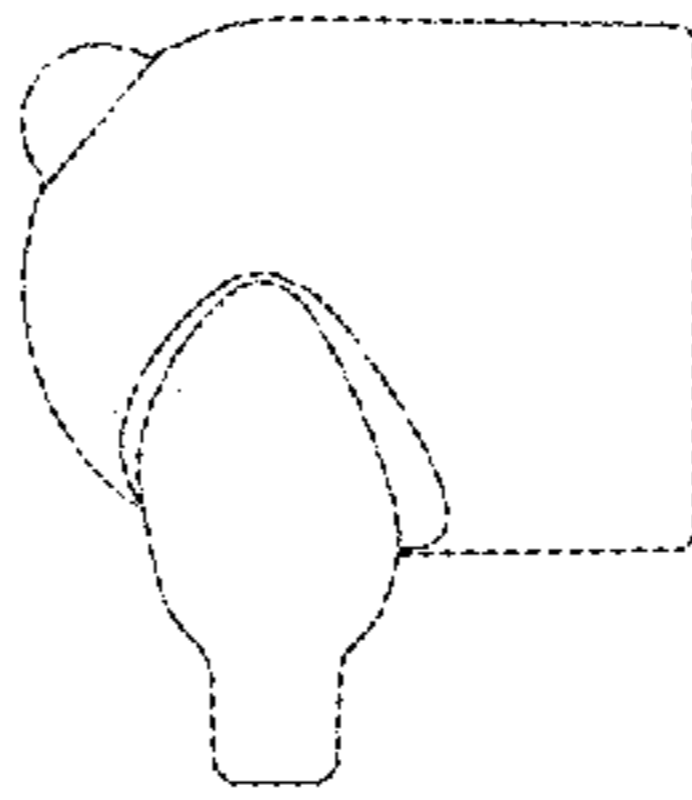

FIG. 116

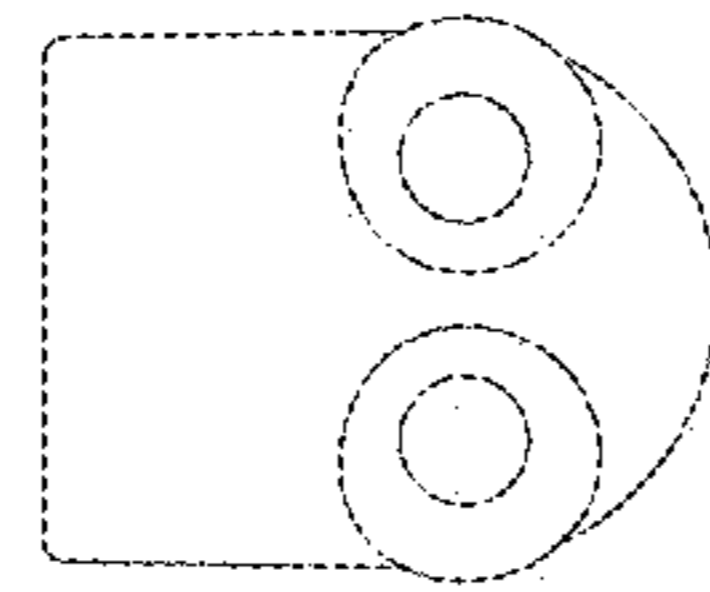

FIG. 117

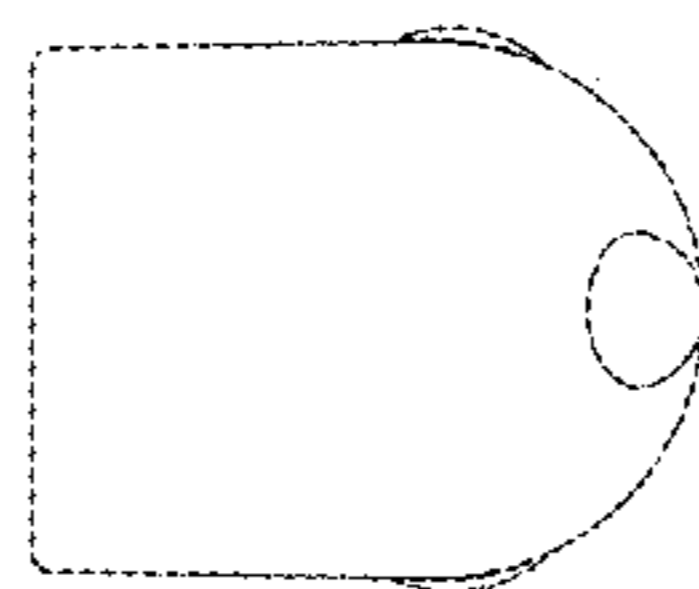

FIG. 118