



US00D926254S

(12) **United States Design Patent** (10) **Patent No.:** **US D926,254 S**  
**Bernfeld** (45) **Date of Patent:** **\*\* Jul. 27, 2021**

- (54) **BAND**
- (71) Applicant: **D.C. Premier Sales, Inc.**, Huntington Station, NY (US)
- (72) Inventor: **Evelyn Bernfeld**, Huntington Station, NY (US)
- (\*\*) Term: **15 Years**
- (21) Appl. No.: **29/707,921**
- (22) Filed: **Oct. 1, 2019**
- (51) **LOC (13) Cl.** ..... **19-08**
- (52) **U.S. Cl.**  
USPC ..... **D20/27**
- (58) **Field of Classification Search**  
USPC ..... D7/387, 624.2; D9/434, 550, 563; D10/46, 47, 52, 104.1, 104.2; D14/490, D14/491; D19/1-12; D20/10, 11, 18, D20/22-29, 42, 49  
CPC ..... G09F 1/00; G09F 1/04; G09F 3/00; G09F 3/005; G09F 3/0288; G09F 3/0289; G09F 3/02; G09F 3/04; G09F 3/06; G09F 3/08; G09F 3/10; G09F 2003/0251; G09F 2003/0273; G06K 19/0776; A61J 9/00  
See application file for complete search history.

- D712,295 S \* 9/2014 Ennis ..... D11/3
- D853,481 S \* 7/2019 Davis ..... D19/1
- D883,379 S \* 5/2020 Lorenzo ..... D19/99
- 2002/0073587 A1 \* 6/2002 Twentier ..... G09F 15/0087  
40/633
- 2004/0104274 A1 \* 6/2004 Kotik ..... G06K 19/04  
235/492
- 2006/0087437 A1 \* 4/2006 Lerch ..... G08B 21/0286  
340/572.8
- 2006/0092028 A1 \* 5/2006 Lerch ..... G08B 13/2448  
340/572.8
- 2006/0254105 A1 \* 11/2006 Chang ..... G09F 3/005  
40/633

(Continued)

OTHER PUBLICATIONS

Pill Organizer Bag search results on Amazon.com, Accessed Oct. 1, 2019.

(Continued)

*Primary Examiner* — Mary Ann Calabrese  
*Assistant Examiner* — Catherine Ho  
 (74) *Attorney, Agent, or Firm* — Davidson Law Group, ALC; Payam Moradian

(57) **CLAIM**

I claim the ornamental design for a band, as shown and described.

**DESCRIPTION**

FIG. 1 is a side perspective view of a band, showing my new design;  
 FIG. 2 is a front side view thereof;  
 FIG. 3 is a back side view thereof;  
 FIG. 4 is a right side view thereof;  
 FIG. 5 is a left side view thereof;  
 FIG. 6 is a top view thereof; and,  
 FIG. 7 is a bottom view thereof.

**1 Claim, 4 Drawing Sheets**

- (56) **References Cited**  
U.S. PATENT DOCUMENTS
- 2,884,724 A \* 5/1959 Lohnes ..... B42D 15/045  
446/151
- D316,570 S \* 4/1991 Golden ..... D20/22
- D433,069 S \* 10/2000 Livingston ..... D20/22
- D433,070 S \* 10/2000 Weststrate ..... D20/22
- 6,546,656 B2 \* 4/2003 Twentier ..... G09F 3/005  
40/633
- D595,348 S \* 6/2009 Joseph ..... D19/1
- D613,451 S \* 4/2010 Welsh ..... D28/4
- D645,093 S \* 9/2011 Manko ..... D20/27
- D665,456 S \* 8/2012 Bell ..... G09F 7/10  
D20/18
- D676,490 S \* 2/2013 Bratter ..... D20/27

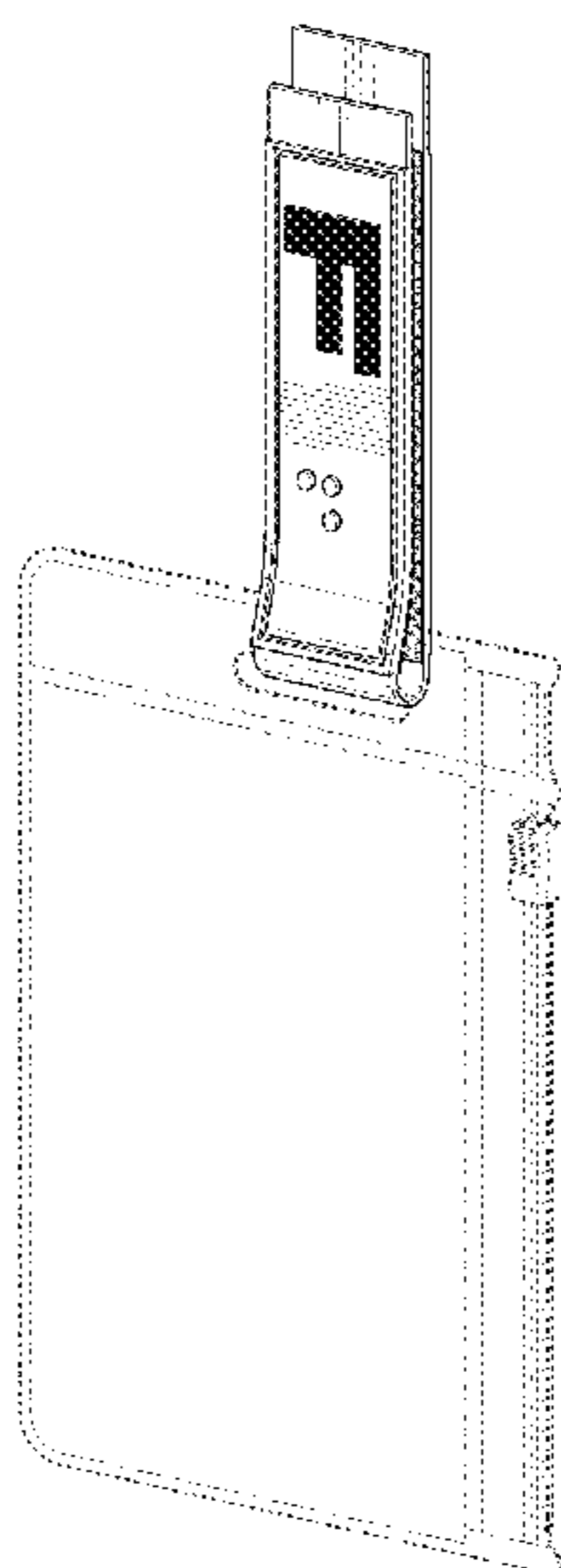

(56)

**References Cited**

U.S. PATENT DOCUMENTS

2020/0107994 A1\* 4/2020 Bernfeld ..... A45C 3/06

OTHER PUBLICATIONS

Pill Organizer Bag search results on Google Images, Accessed Oct. 1, 2019.

\* cited by examiner

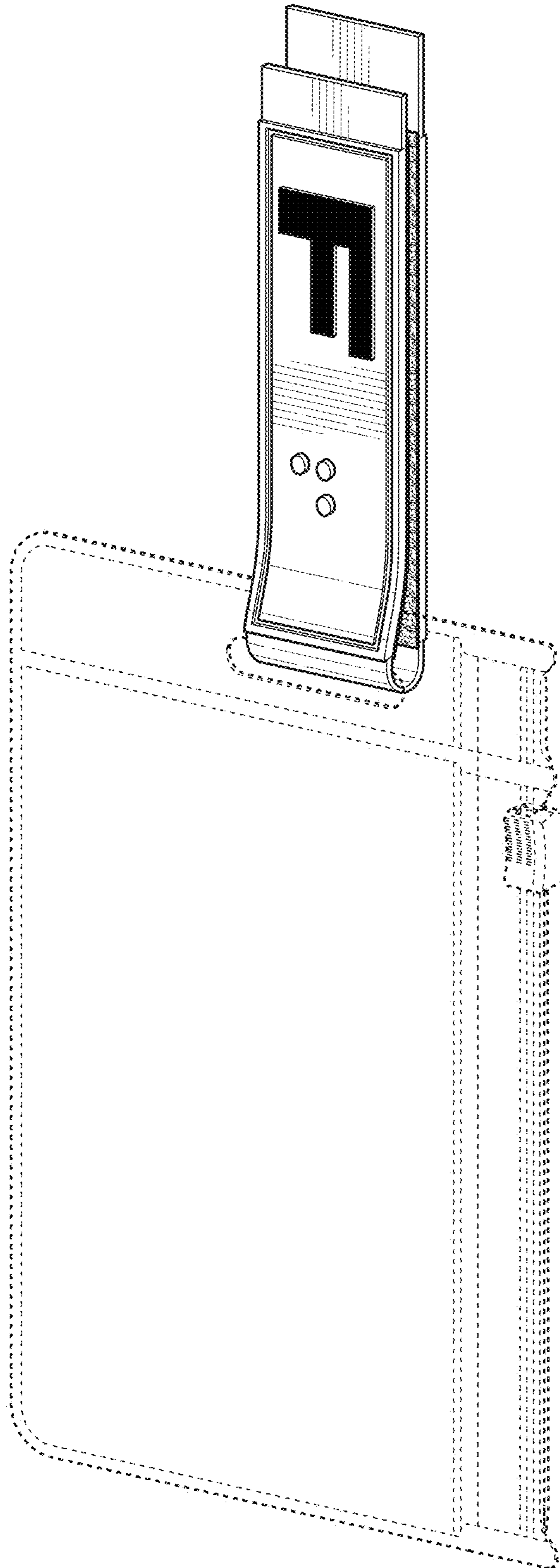

FIG. 1

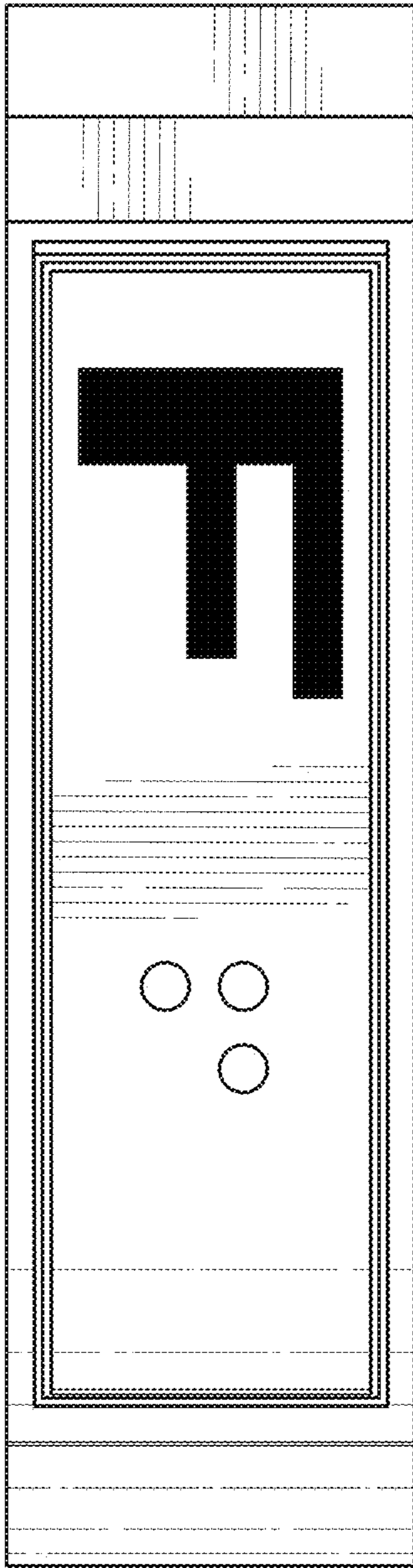

FIG. 2

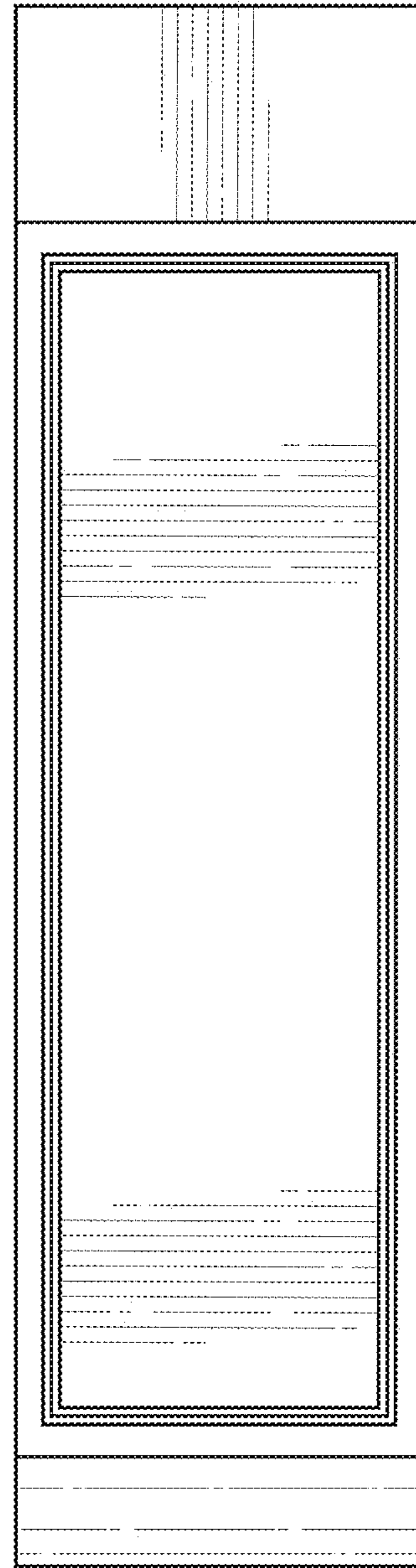
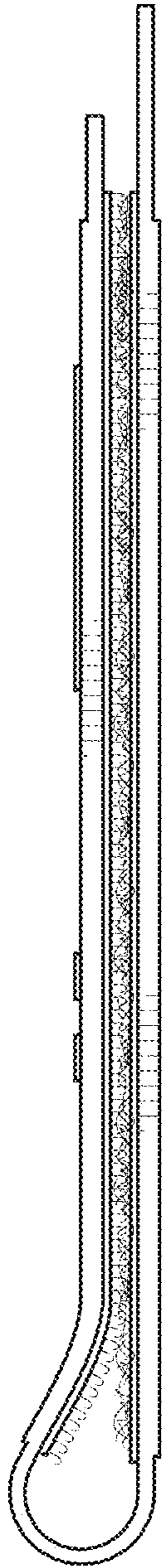
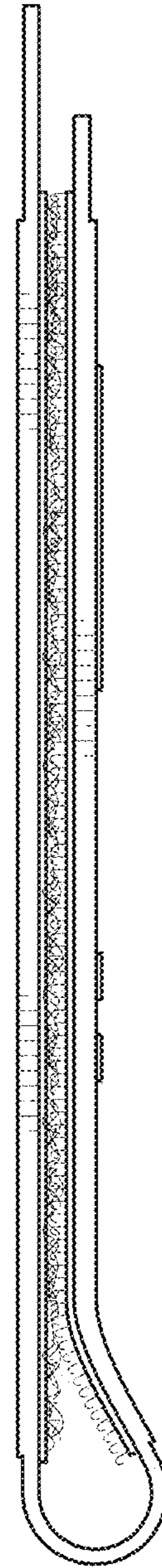

FIG. 3



**FIG. 4**



**FIG. 5**

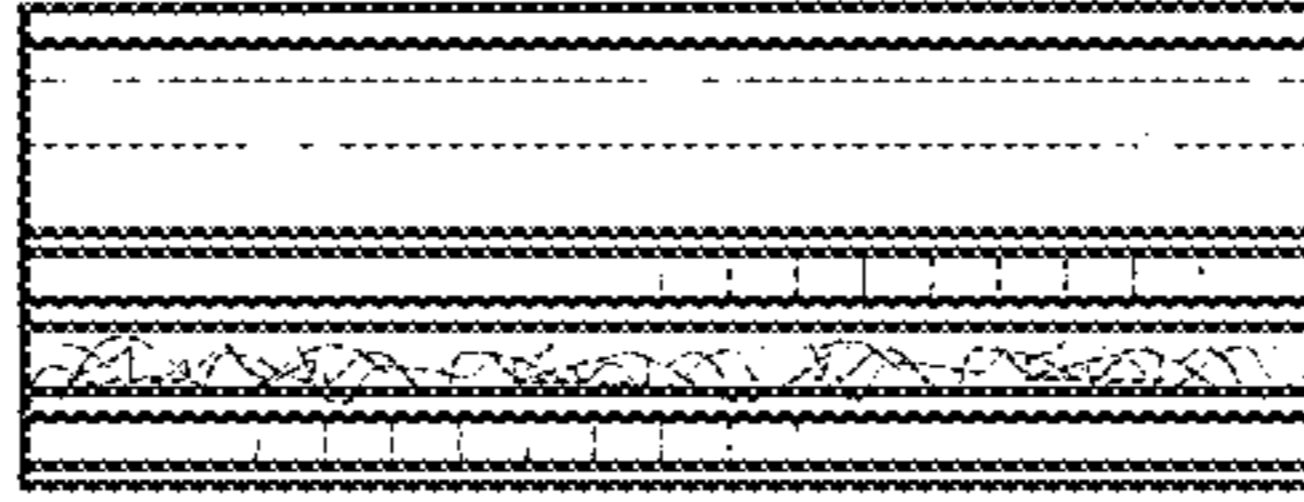

**FIG. 6**

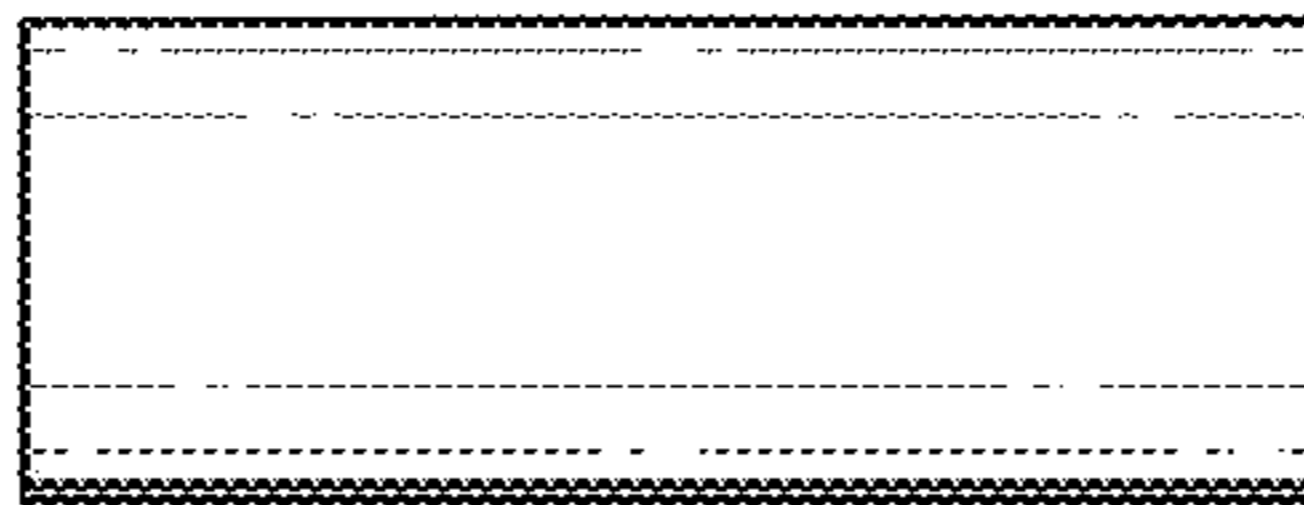

**FIG. 7**