

US00D926125S

(12) **United States Design Patent**
Chang

(10) **Patent No.:** **US D926,125 S**

(45) **Date of Patent:** **** Jul. 27, 2021**

(54) **ENGINE STARTER BOOSTER**

(71) Applicant: **Solomon Chang**, Keelung (TW)

(72) Inventor: **Solomon Chang**, Keelung (TW)

(**) Term: **15 Years**

(21) Appl. No.: **29/723,905**

(22) Filed: **Feb. 11, 2020**

(51) **LOC (13) Cl.** **13-02**

(52) **U.S. Cl.**
USPC **D13/107**

(58) **Field of Classification Search**
USPC D13/103, 106, 109, 107, 108, 110, 119,
D13/120, 149, 184, 199, 118; D15/5;
D14/356, 432
CPC H02J 7/1446; F02N 11/12; F02N 11/14;
F02N 2011/0896
See application file for complete search history.

(56) **References Cited**

U.S. PATENT DOCUMENTS

D840,336 S * 2/2019 Labbe D13/110
D885,329 S * 5/2020 Gan D13/107
D886,045 S * 6/2020 Deng D13/103

D892,039 S * 8/2020 Chen D13/103
D892,727 S * 8/2020 Gan D13/107
D902,849 S * 11/2020 Wu D13/107
D902,851 S * 11/2020 Wu D13/107
2015/0054336 A1* 2/2015 Xinfang B60R 16/033
307/9.1
2016/0308382 A1* 10/2016 Pan F02N 11/00
2016/0359352 A1* 12/2016 Chiu F02N 11/12
2019/0222042 A1* 7/2019 Nook H01H 19/025
2020/0313455 A1* 10/2020 Adamany H02J 7/0042
2021/0044133 A1* 2/2021 Gong H02J 50/80

* cited by examiner

Primary Examiner — Ania Aman

(57) **CLAIM**

The ornamental design for an engine starter booster, as shown.

DESCRIPTION

FIG. 1 is a perspective view of an engine starter booster showing my new design;
FIG. 2 is a front view thereof;
FIG. 3 is a rear view thereof;
FIG. 4 is a left view thereof;
FIG. 5 is a right view thereof;
FIG. 6 is a top view thereof; and,
FIG. 7 is a bottom view thereof.

1 Claim, 4 Drawing Sheets

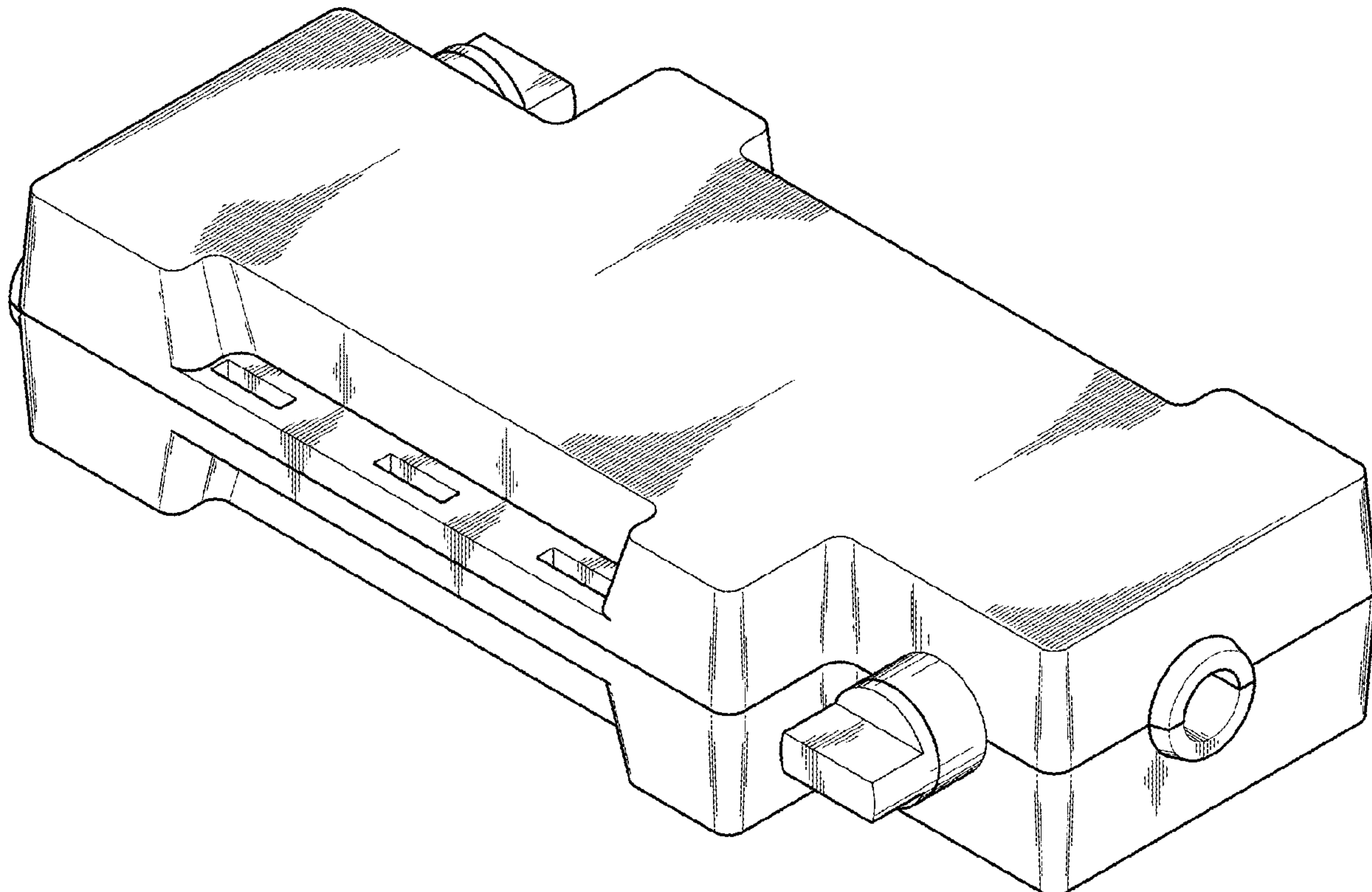

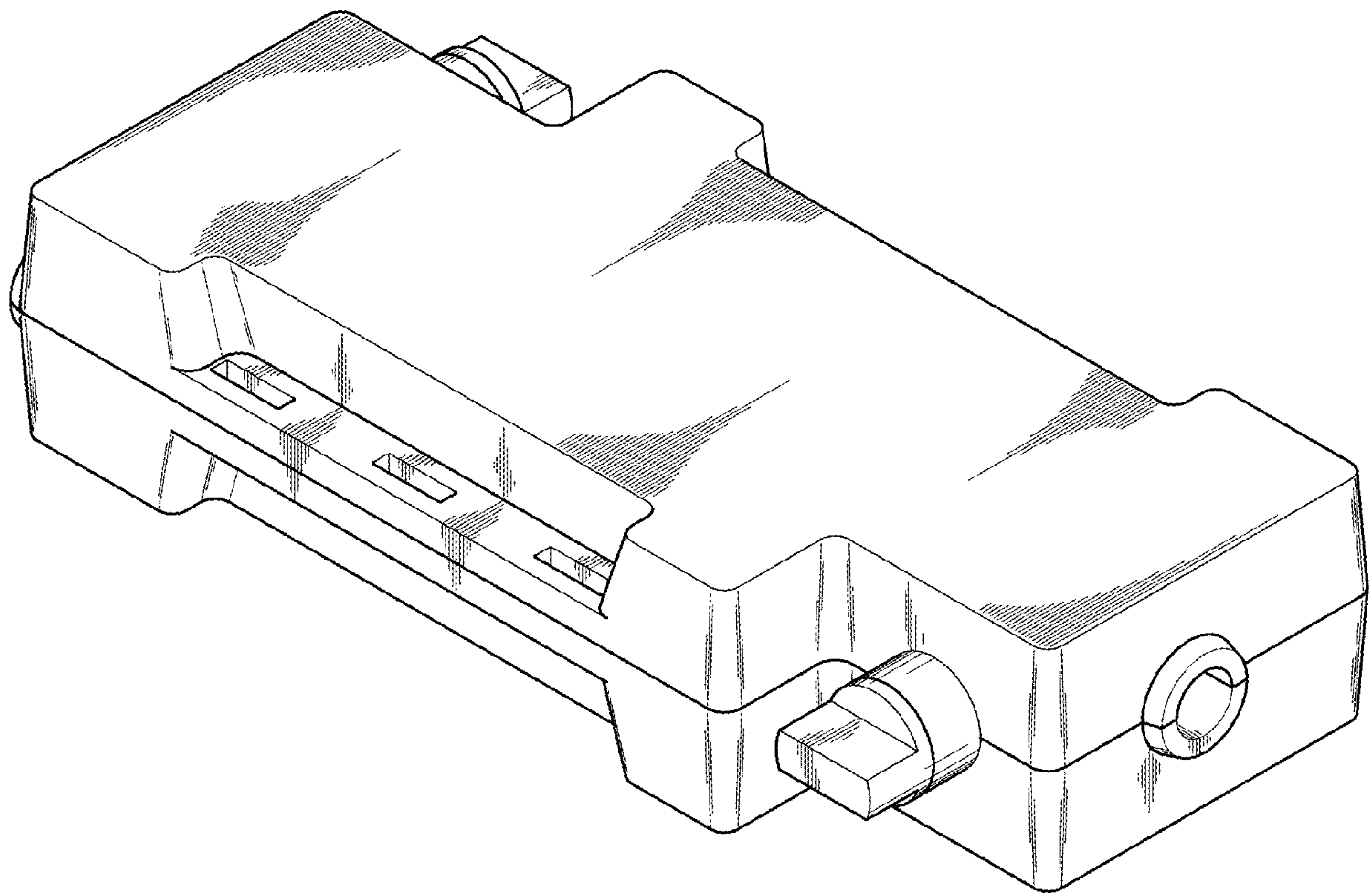

Fig.1

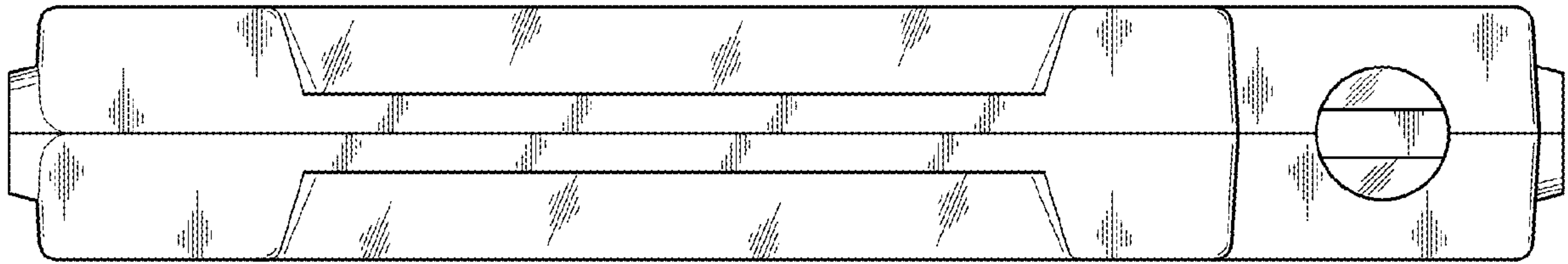

Fig.2

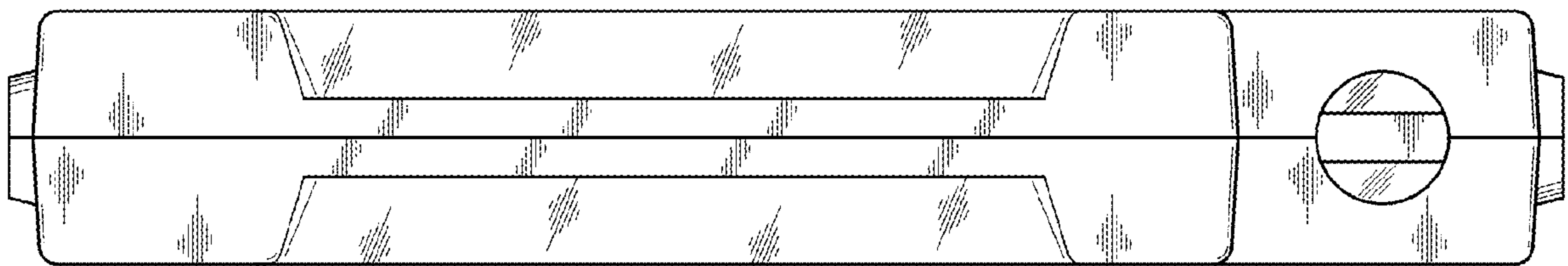

Fig.3

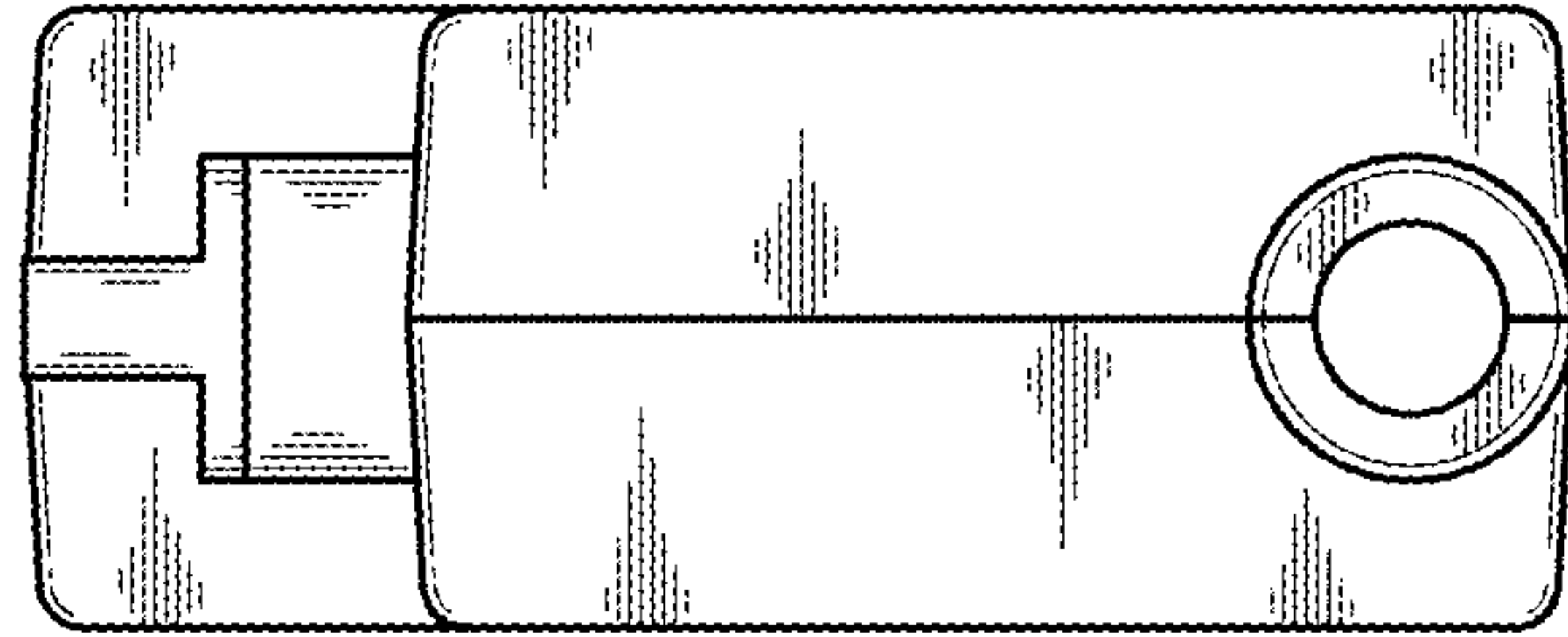

Fig.4

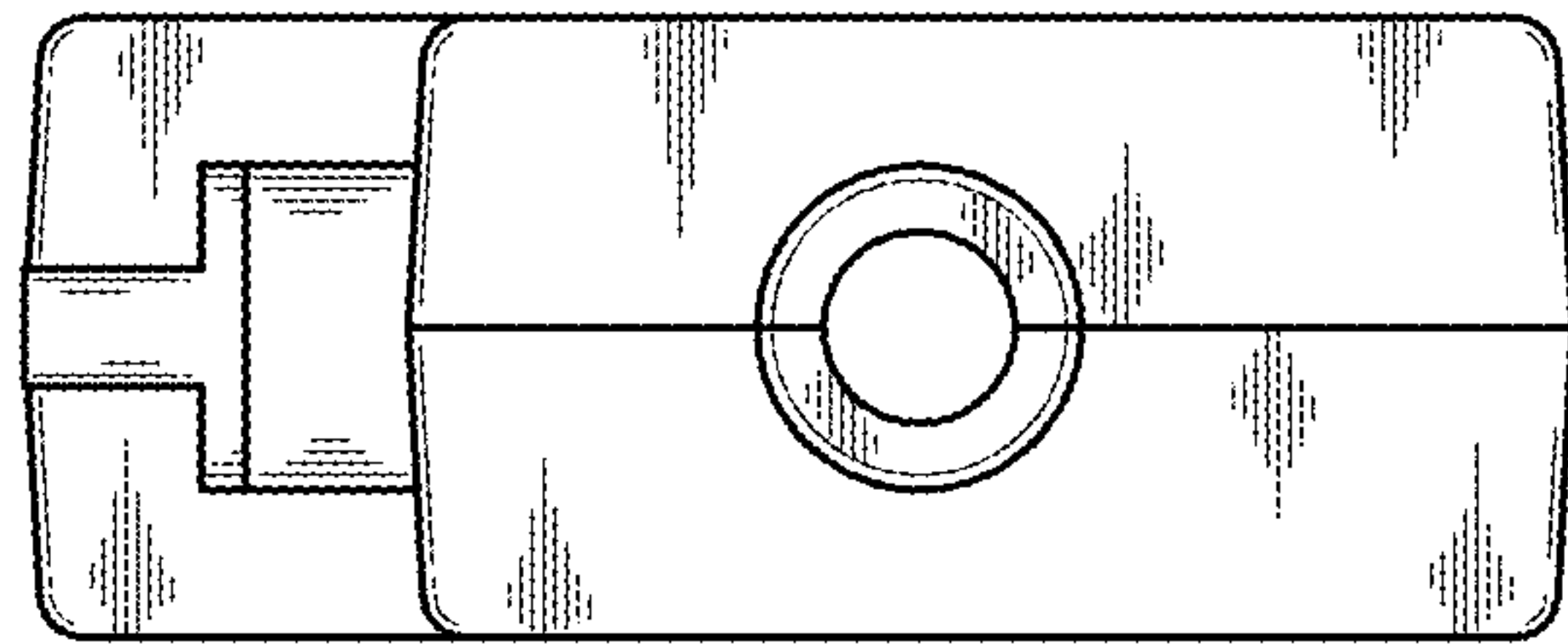

Fig.5

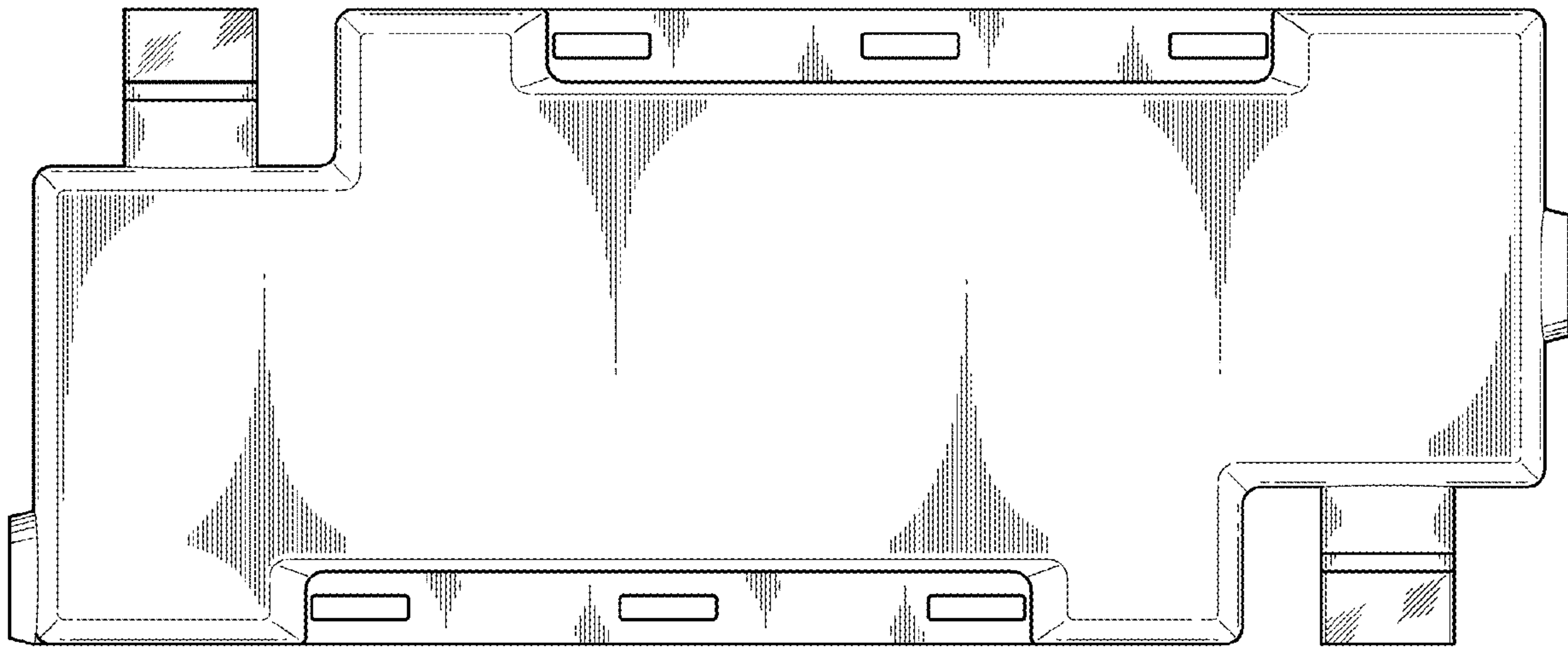

Fig.6

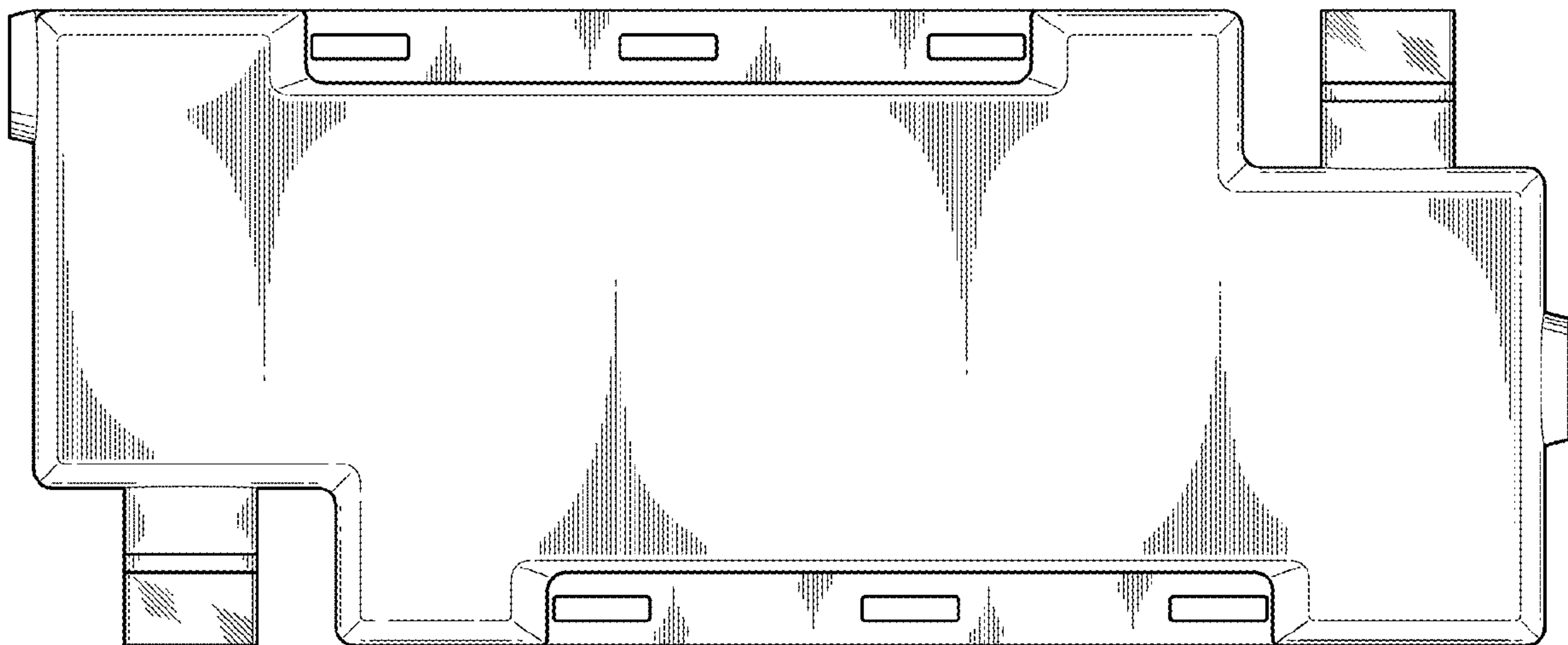

Fig.7