



US00D926084S

(12) **United States Design Patent** (10) **Patent No.:** **US D926,084 S**
Borden (45) **Date of Patent:** **** Jul. 27, 2021**

(54) **MOBILE SHOWROOM ADVERTISING SYSTEM**

(71) Applicant: **Aardvark Event Logistics, Inc.**,
Huntingdon Valley, PA (US)

(72) Inventor: **Lawrence Wayne Borden**, Huntingdon
Valley, PA (US)

(73) Assignee: **Aardvark Event Logistics, Inc.**,
Huntingdon Valley, PA (US)

(**) Term: **15 Years**

(21) Appl. No.: **29/690,317**

(22) Filed: **May 7, 2019**

Related U.S. Application Data

(63) Continuation of application No. 29/589,779, filed on
Jan. 4, 2017, now Pat. No. Des. 847,695.

(51) **LOC (13) Cl.** **12-08**

(52) **U.S. Cl.**
USPC **D12/93**

(58) **Field of Classification Search**

USPC D12/93, 96, 97, 99, 102; D20/19, 35
CPC B60P 3/0252; B60P 3/0255; B60P 3/0257;
G09F 21/04; G09F 21/048; A47F 7/30;
E04B 1/3442; E04B 1/34336

See application file for complete search history.

(56) **References Cited**

U.S. PATENT DOCUMENTS

- 3,258,019 A 6/1966 Bellas
- 3,492,042 A * 1/1970 Nachtigall, Jr. B60P 3/32
296/24.45
- 3,534,997 A * 10/1970 Mitchell, Jr. B60P 3/0257
296/176
- 3,620,564 A * 11/1971 Wenger B60P 3/0252
296/83
- 4,019,773 A 4/1977 Vehling

- D247,290 S * 2/1978 Arnot, Jr. D12/97
- 4,232,488 A * 11/1980 Hanley B60P 3/0252
108/166
- 4,601,509 A * 7/1986 Ellis, Sr. B60P 3/0257
296/22

(Continued)

FOREIGN PATENT DOCUMENTS

KR 1020160115172 10/2016

OTHER PUBLICATIONS

Aardvark Mobile Tours Home Facebook <https://www.facebook.com/mobiletours/photos/a.135812687238/10155435076532239/?type=3&theater> Feb. 22, 2018 (Year: 2018).*

(Continued)

Primary Examiner — Leanne Was-Englehart

(74) *Attorney, Agent, or Firm* — Blank Rome LLP

(57) **CLAIM**

The ornamental design for a mobile showroom advertising system, as shown and described.

DESCRIPTION

FIG. 1 is a front view of a mobile showroom advertising system of my design in a closed position; FIG. 2 is a rear view thereof; FIG. 3 is a top view therefor; FIG. 4 is a right side thereof; FIG. 5 is a left side view thereof; FIG. 6 is a front view thereof in an opened position; FIG. 7 is a rear view thereof in an opened position; FIG. 8 is a top view therefor in an opened position; FIG. 9 is a right side thereof in an opened position; and, FIG. 10 is a right side perspective view thereof in an opened position.

The broken lines in the drawings depict portions of the mobile showroom advertising system that form no part of the claimed design.

1 Claim, 7 Drawing Sheets

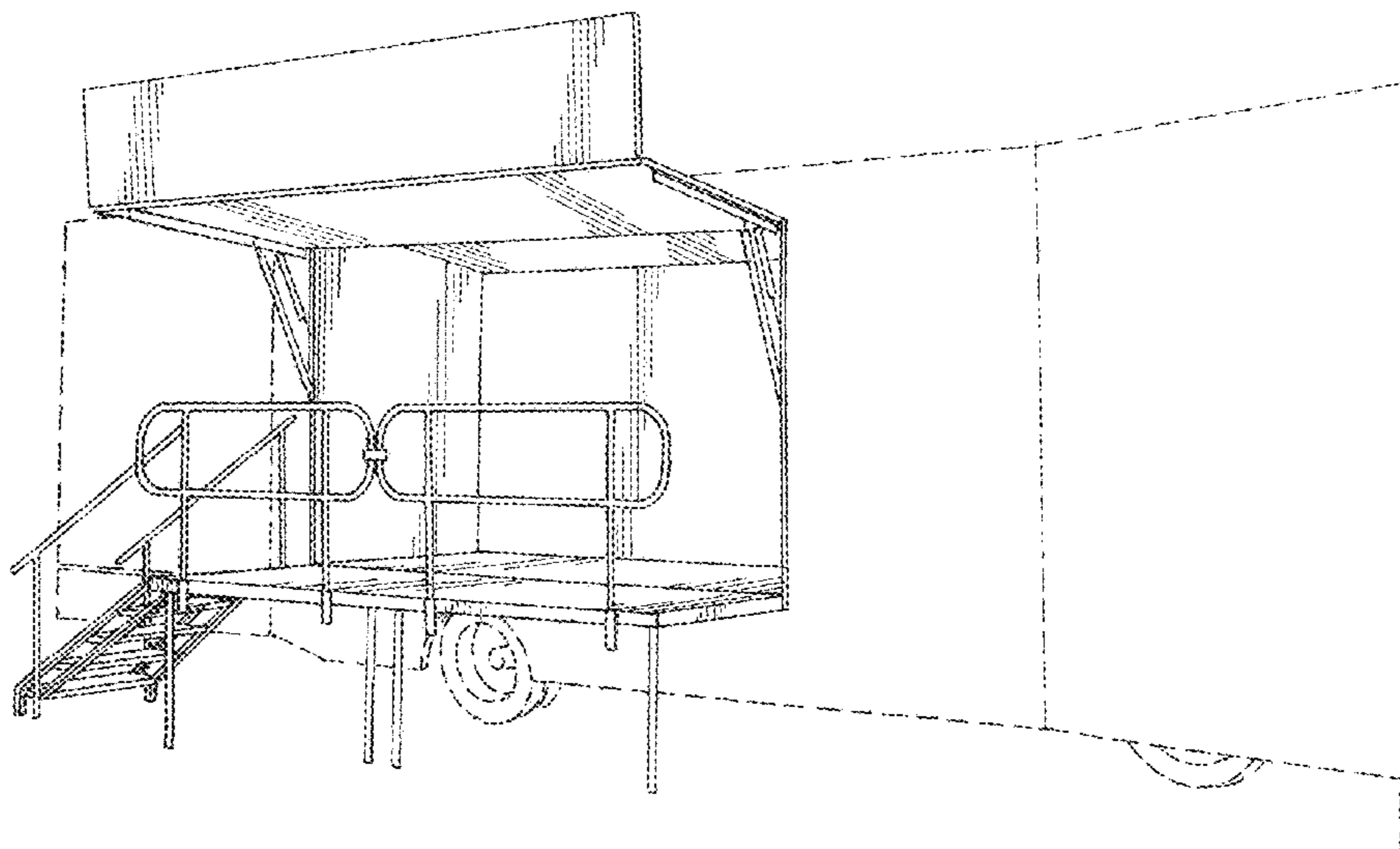

(56)

References Cited

U.S. PATENT DOCUMENTS

D300,012 S * 2/1989 Boice, Jr. D12/97
 4,958,874 A * 9/1990 Hegedus B60P 3/0252
 296/175
 5,310,209 A * 5/1994 Holman B60P 3/0255
 280/43.1
 5,375,899 A * 12/1994 Wright B60P 3/025
 296/21
 5,706,616 A * 1/1998 Fernandez B60P 3/0252
 296/24.3
 D400,124 S * 10/1998 Mason D12/93
 5,833,294 A 11/1998 Williams
 D413,838 S * 9/1999 McDaniel D12/97
 D426,493 S 6/2000 Mertins et al.
 6,585,305 B2 * 7/2003 Nazginov B60P 3/0255
 296/21
 D491,844 S * 6/2004 Poulin D12/93
 D533,115 S * 12/2006 Delamour D12/93
 D551,128 S * 9/2007 Renard D12/102
 7,287,349 B1 10/2007 MacDonald et al.
 7,621,576 B2 * 11/2009 Cote B60P 3/0255
 296/24.3
 D656,866 S * 4/2012 Wise D12/93
 8,506,301 B2 * 8/2013 Jaszlics G09B 9/00
 434/29
 D701,470 S * 3/2014 Cohen D12/99
 D701,471 S * 3/2014 Cohen D12/99
 D736,675 S * 8/2015 Cohen D12/93

9,458,621 B2 * 10/2016 Calafatis E04B 1/34321
 D782,938 S * 4/2017 Cohen D12/93
 9,700,761 B2 * 7/2017 Beaver B65D 88/121
 9,750,999 B2 * 9/2017 Monaco A63B 71/02
 9,896,017 B1 * 2/2018 Requejo B60P 3/34
 10,160,370 B2 * 12/2018 Borden B60P 3/0255
 10,269,273 B1 * 4/2019 Borden E04B 1/34336
 D847,695 S * 5/2019 Borden D12/93
 2009/0019747 A1 1/2009 Rosa
 2011/0313811 A1 * 12/2011 Urban B60P 3/0257
 705/7.25
 2012/0255240 A1 * 10/2012 Shen E04B 1/34807
 52/79.5
 2017/0158108 A1 * 6/2017 Elbaz B60R 3/02
 2017/0232880 A1 * 8/2017 Peterson B60P 3/0255
 296/21
 2018/0186272 A1 * 7/2018 Borden B60P 3/0255

OTHER PUBLICATIONS

<https://www.aardvarkmobiletours.com/look-book#!>; Nov. 28, 2017;
 2017.
<https://www.facebook.com/mobiletours/photos/a.135812687238.109513.29817547238/10155116314087239>; Oct. 23, 2017.
<https://www.streamcompanies.com/portfolio-piece/aardvark-event-logistics>; Jan. 2017.
https://twitter.com/brian_rebello; Sep. 14, 2016.

* cited by examiner

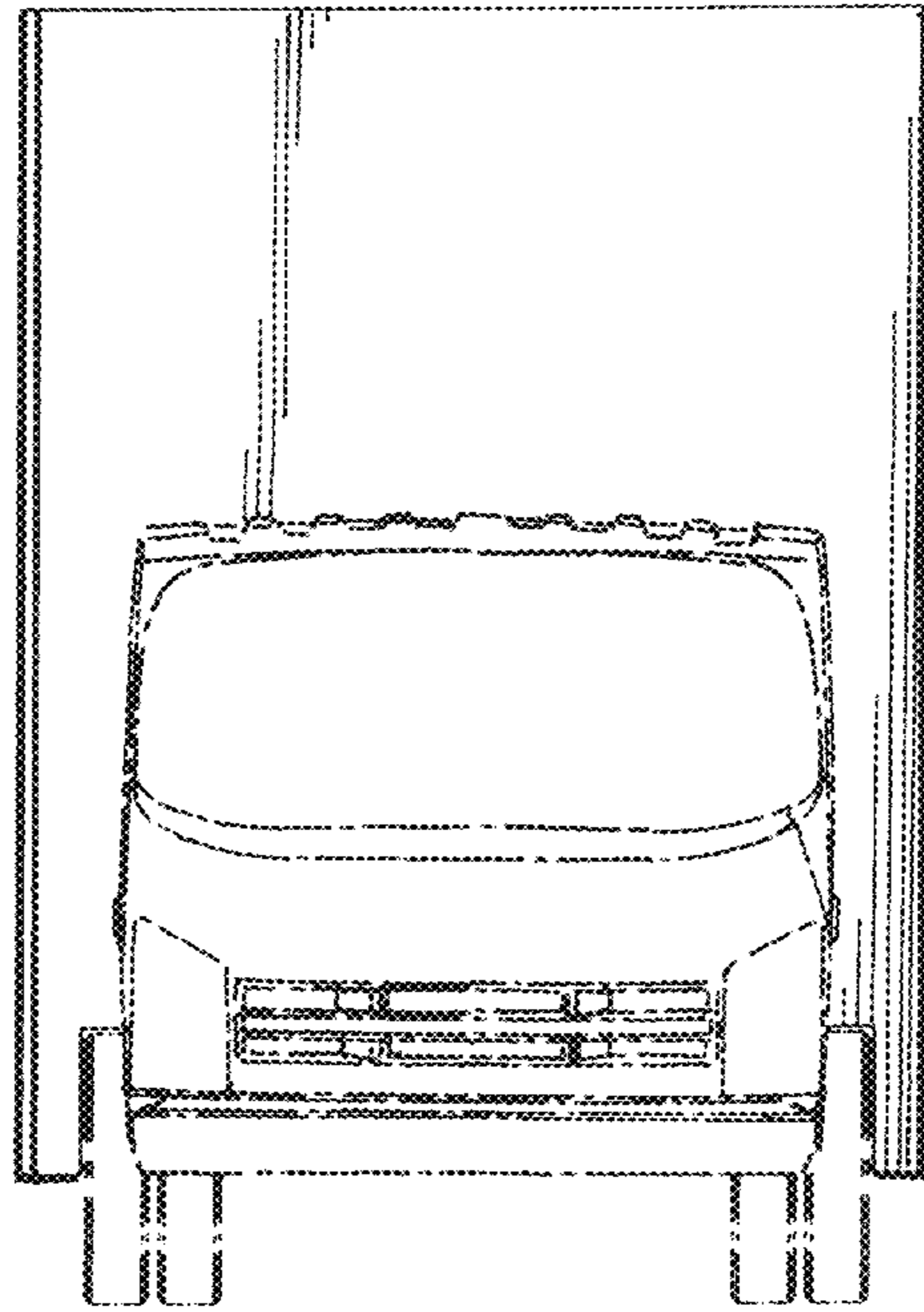

FIG. 1

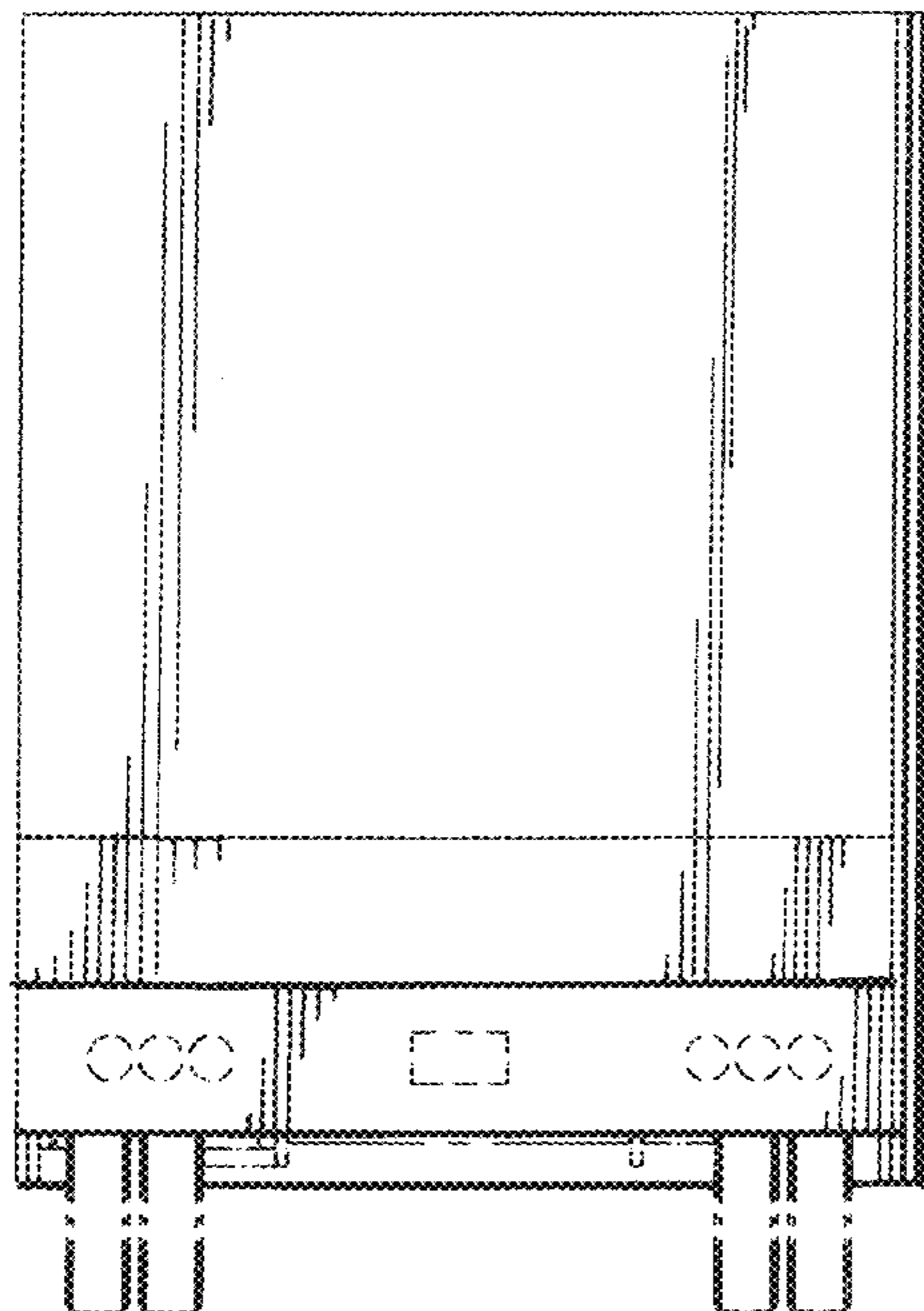

FIG. 2

FIG. 3

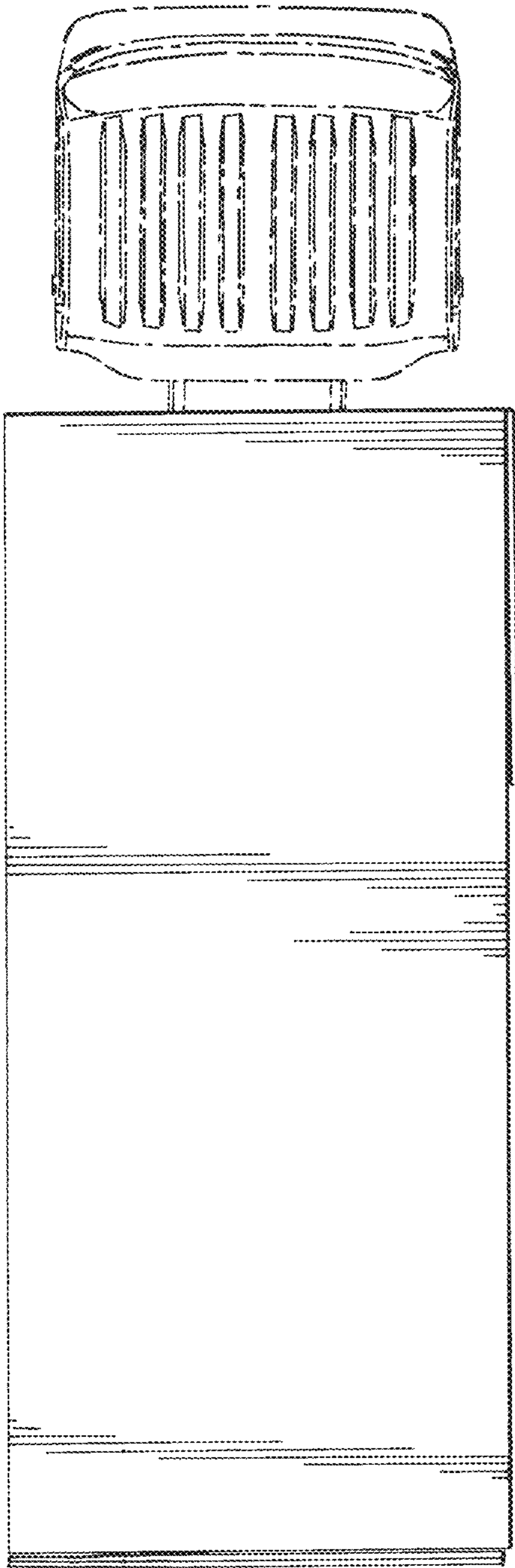
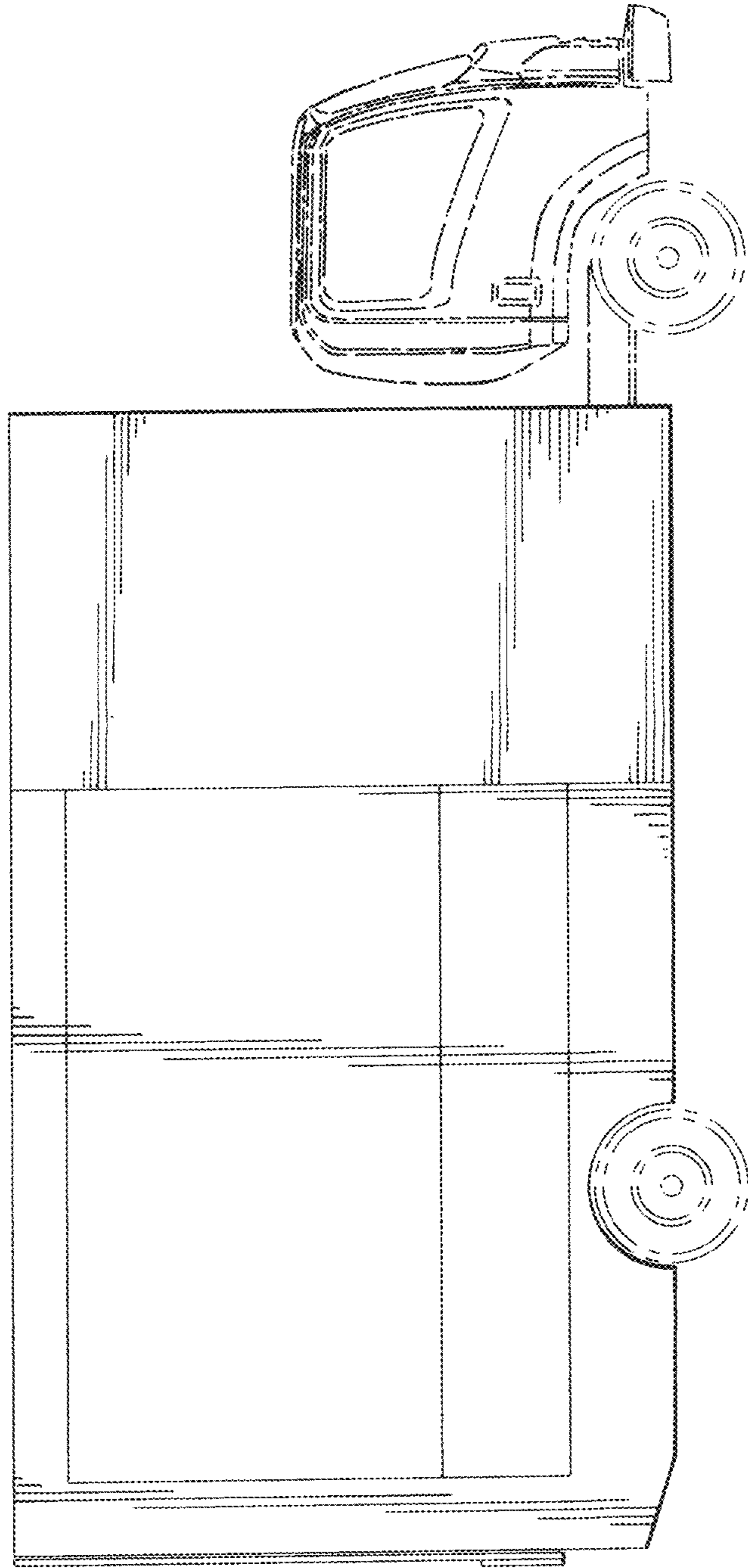

FIG. 4



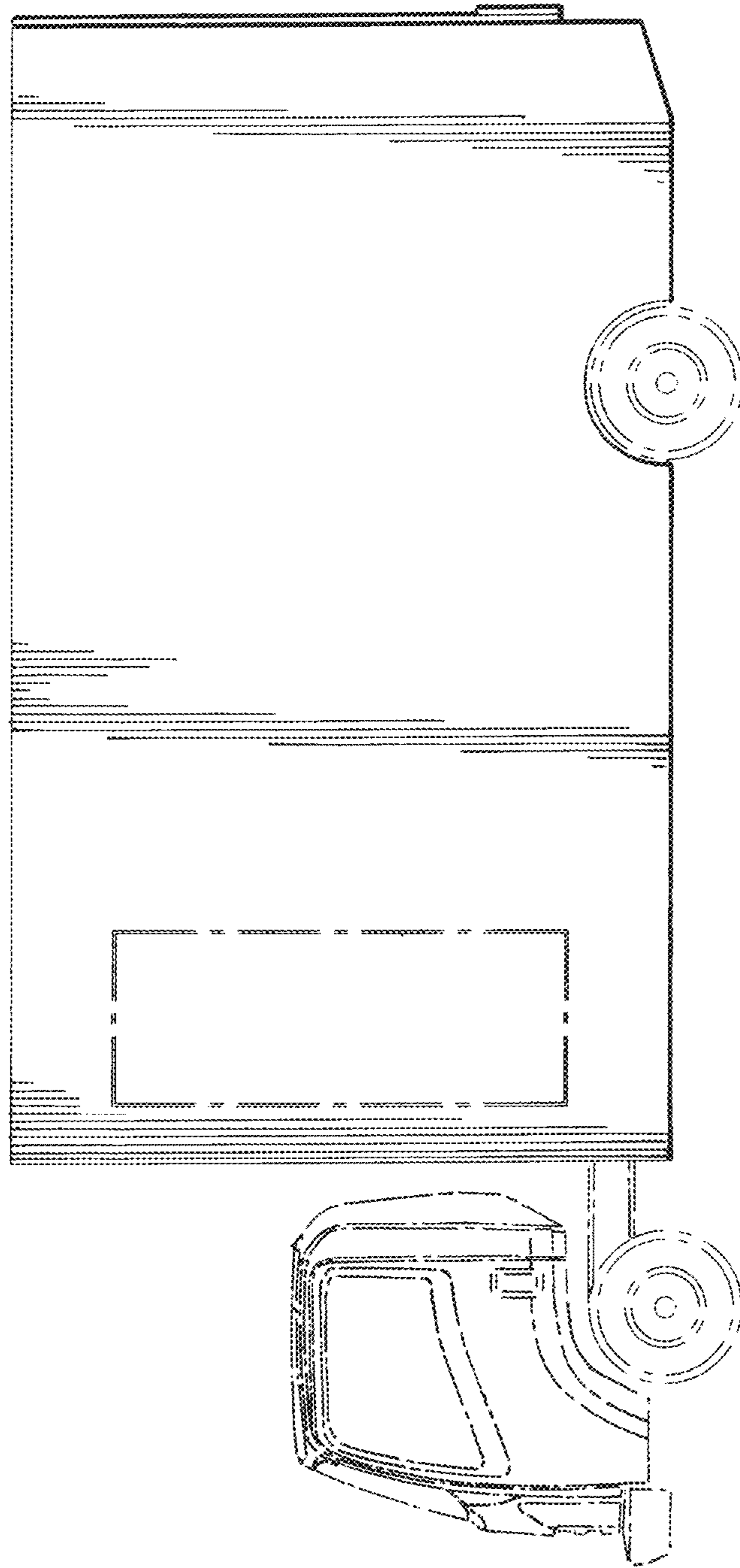

FIG. 5

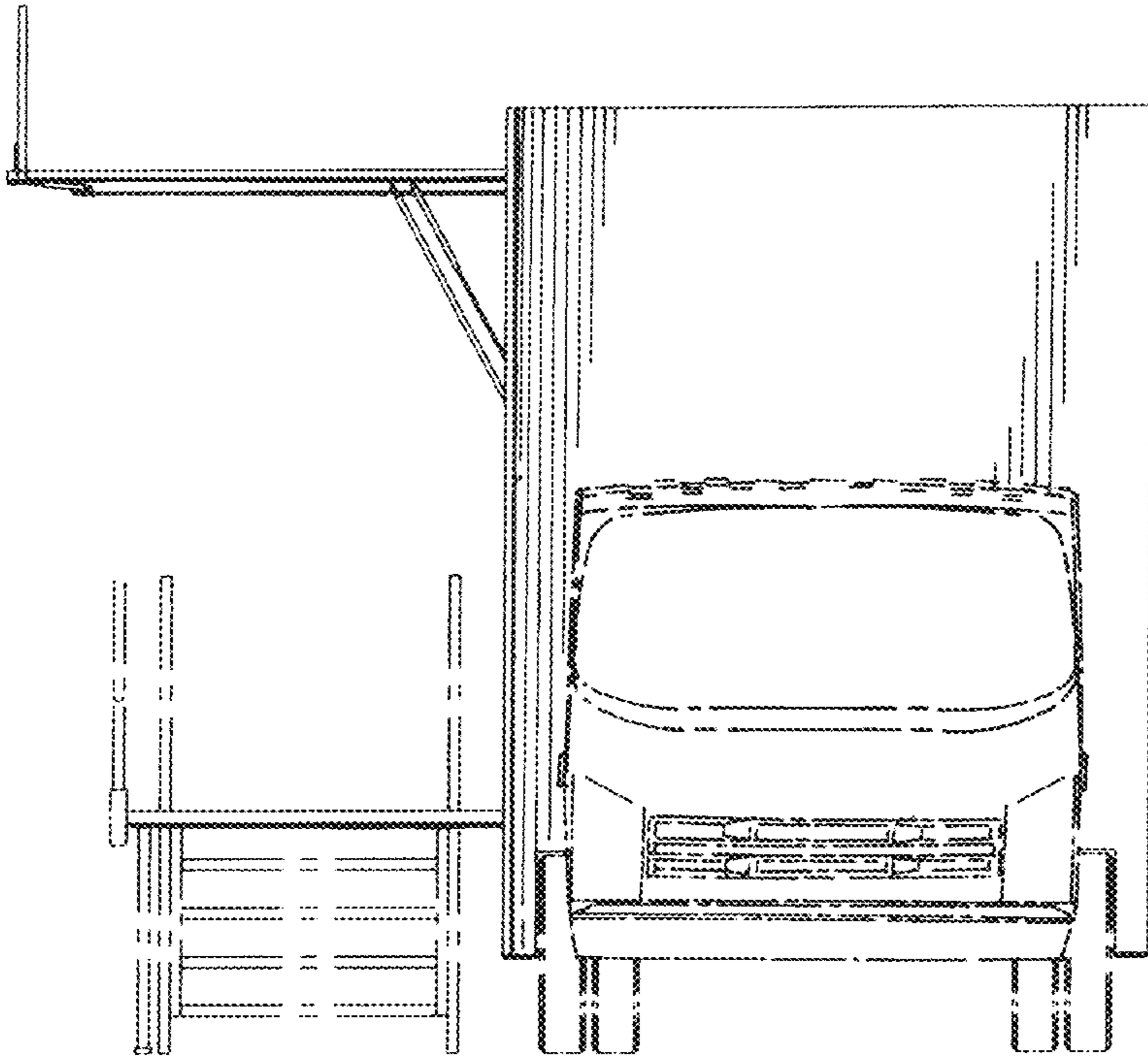

FIG. 6

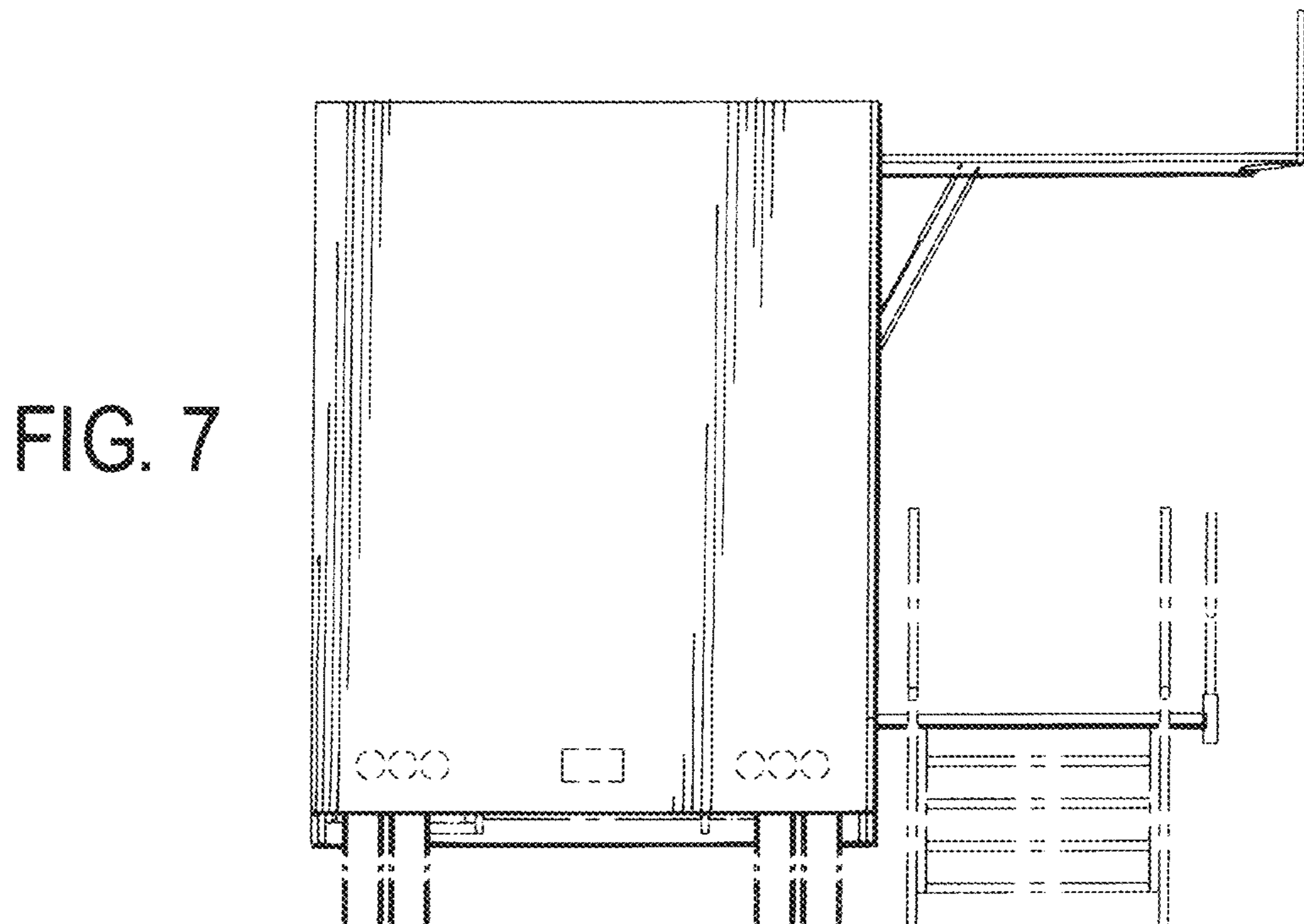

FIG. 7

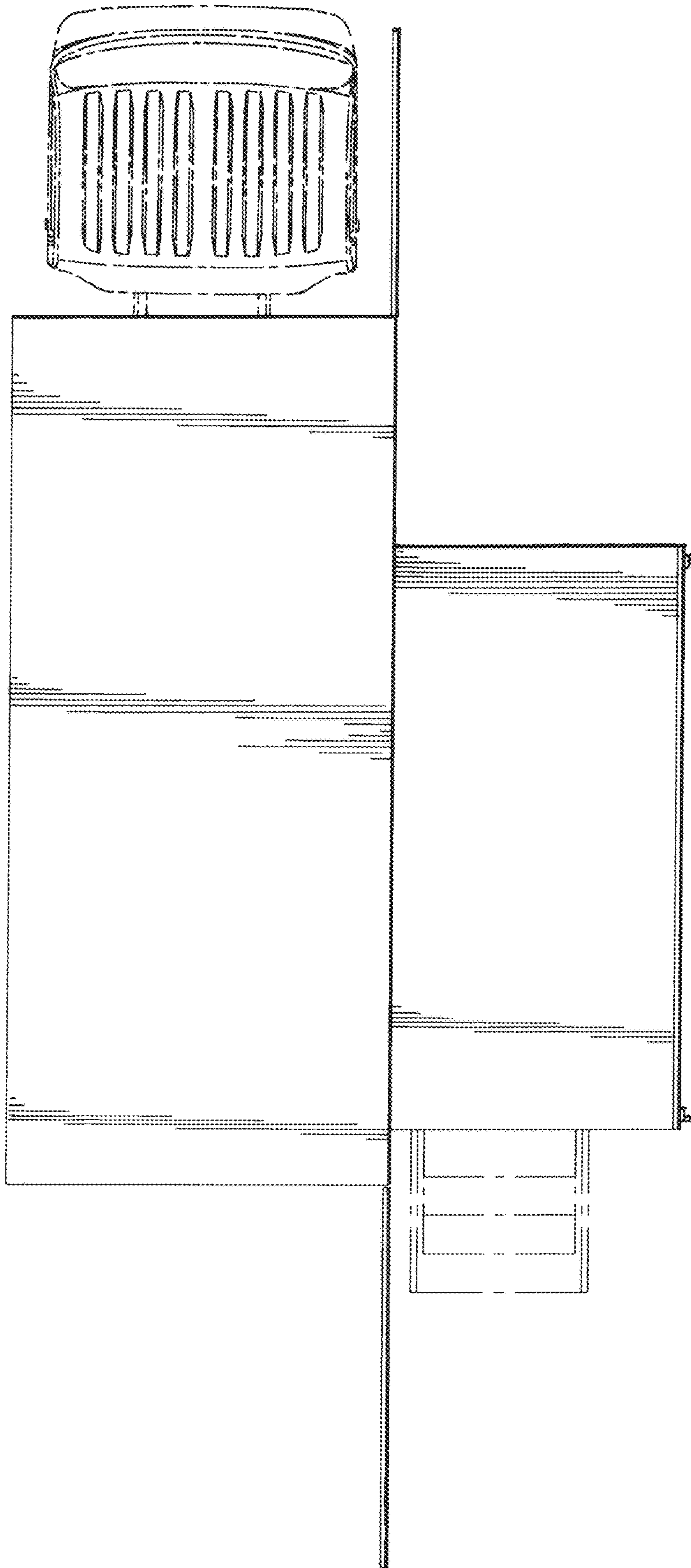

FIG. 8

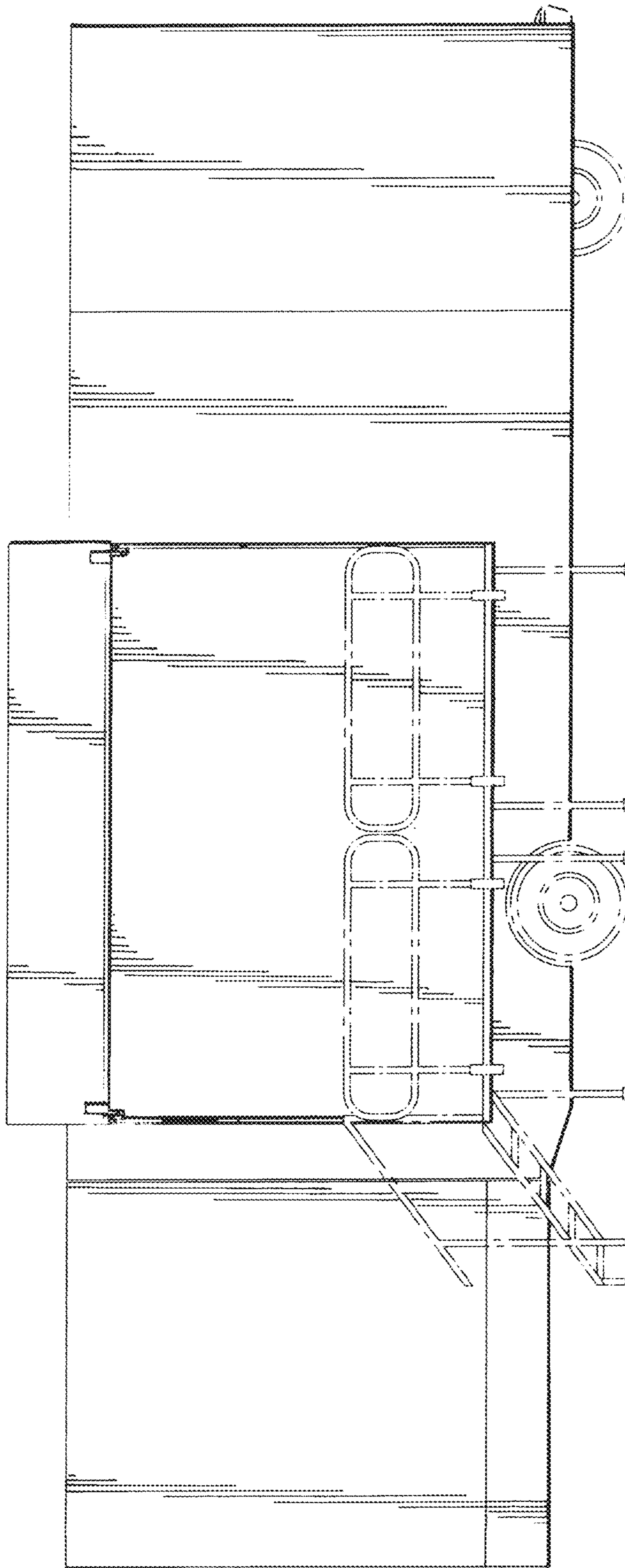

FIG. 9

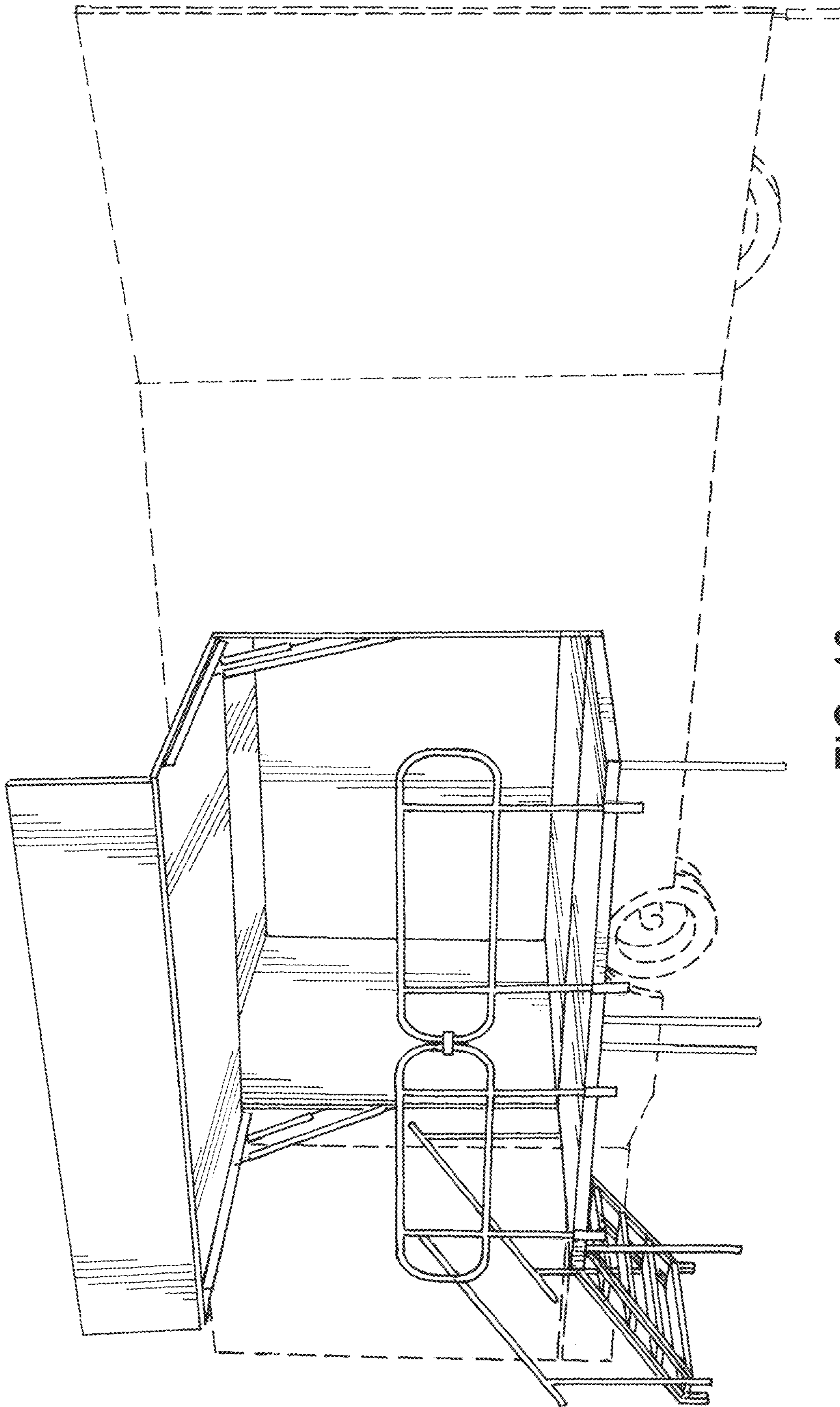

FIG. 10