

US00D926039S

(12) **United States Design Patent**
Yourist

(10) **Patent No.:** **US D926,039 S**

(45) **Date of Patent:** **** Jul. 27, 2021**

(54) **CONTAINER**

(71) Applicant: **Graham Packaging Company, L.P.**,
Lancaster, PA (US)

(72) Inventor: **Sheldon E. Yourist**, York, PA (US)

(73) Assignee: **Graham Packaging Company, L.P.**,
Lancaster, PA (US)

(**) Term: **15 Years**

(21) Appl. No.: **29/648,323**

(22) Filed: **May 21, 2018**

(51) **LOC (13) Cl.** **09-01**

(52) **U.S. Cl.**
USPC **D9/542; D9/560; D9/574**

(58) **Field of Classification Search**
USPC D9/434, 516, 520, 559, 560, 572, 573,
D9/574, 575
CPC B65D 1/00; B65D 1/02; B65D 1/0223;
B65D 1/023; B65D 23/00; B65D
2501/00; B65D 2501/0009; B65D
2501/0081

See application file for complete search history.

(56) **References Cited**

U.S. PATENT DOCUMENTS

D596,949 S * 7/2009 Flude D9/560
D686,081 S * 7/2013 Colangelo D9/560

D762,480 S * 8/2016 Yourist D9/542
D784,821 S * 4/2017 Kuzma D9/560
D832,109 S * 10/2018 Clelland D9/542

* cited by examiner

Primary Examiner — Dana Meyrow

(74) *Attorney, Agent, or Firm* — Baker Botts L.L.P.

(57) **CLAIM**

The ornamental design for a container, as shown and described.

DESCRIPTION

FIG. 1 is a top front perspective view of a container as claimed.

FIG. 2 is a front view of the container of FIG. 1.

FIG. 3 is a rear view of the container of FIG. 1.

FIG. 4 is a left view of the container of FIG. 1.

FIG. 5 is a right view of the container of FIG. 1.

FIG. 6 is a top view of the container of FIG. 1; and,

FIG. 7 is a bottom view of the container of FIG. 1.

The broken lines in the drawings showing the neck finish in FIGS. 1-6 and the bottom surface in FIG. 7 illustrate the portions of the container that form no part of the claimed design.

1 Claim, 4 Drawing Sheets

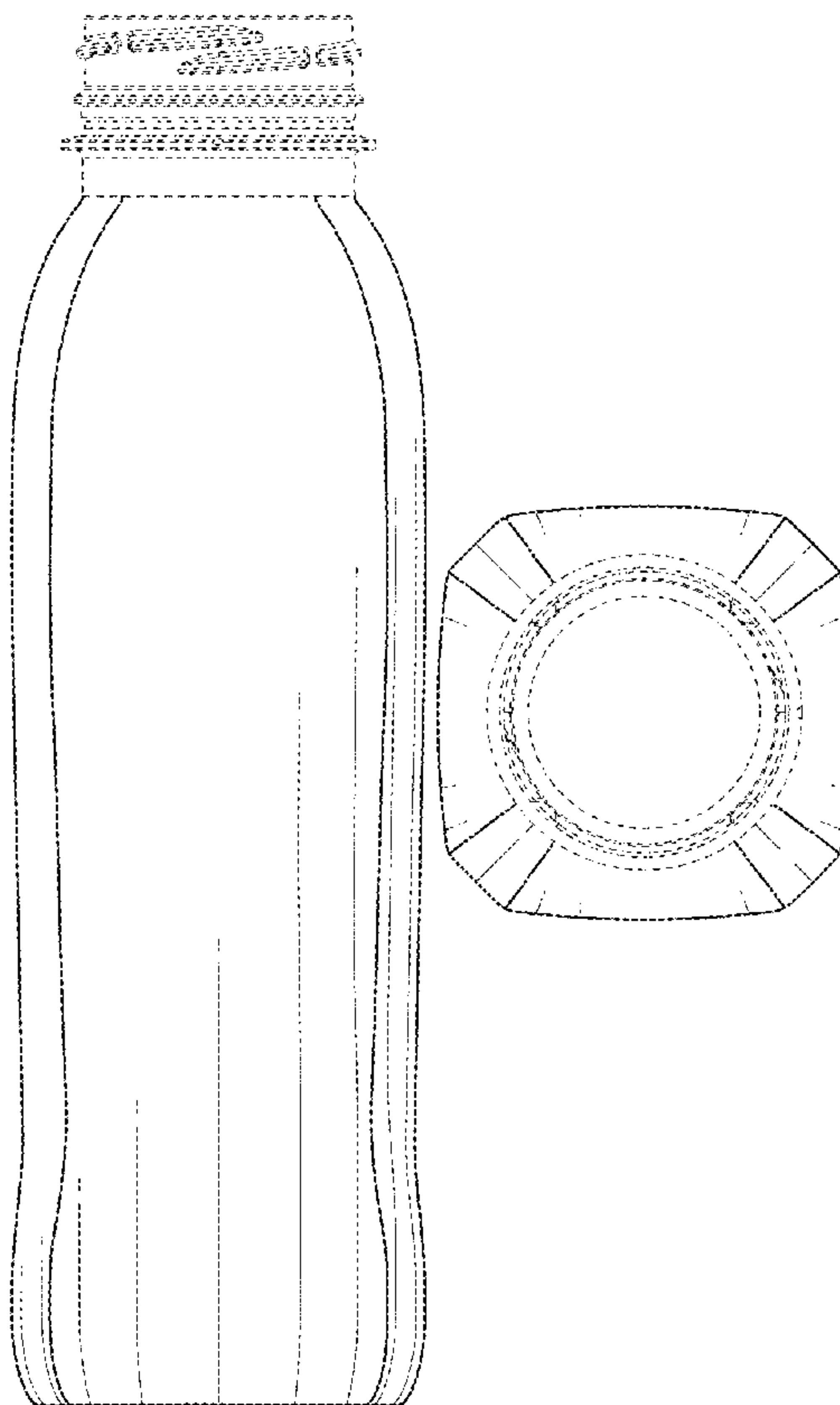

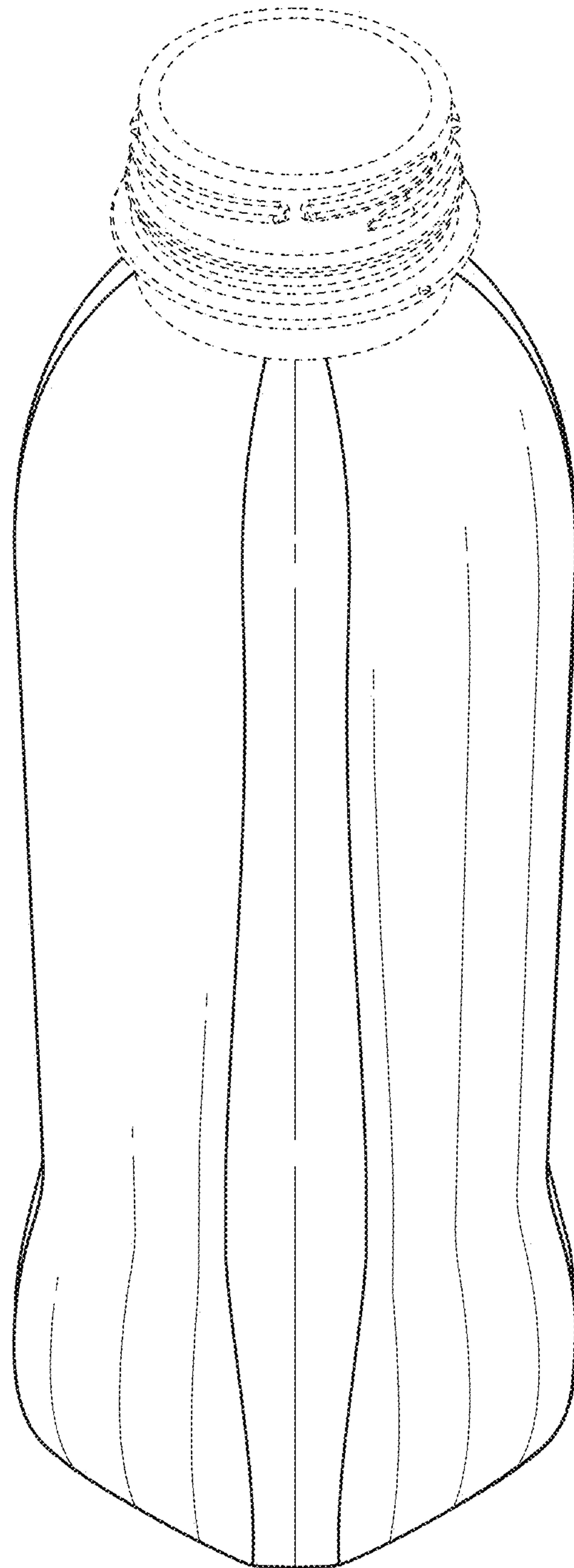

FIG. 1

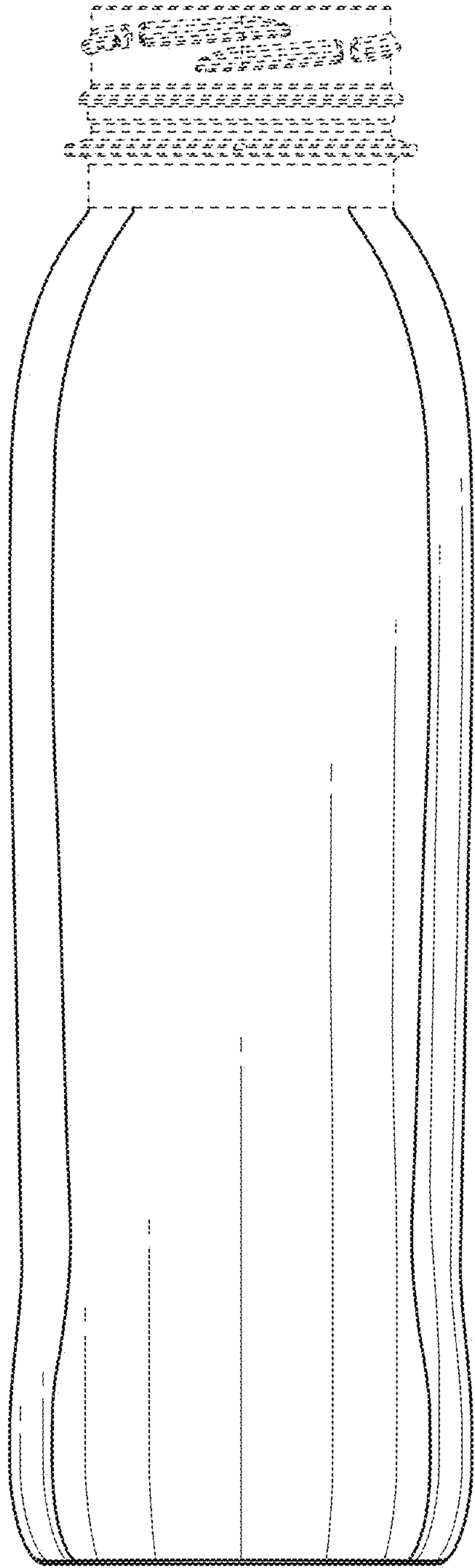

FIG. 2

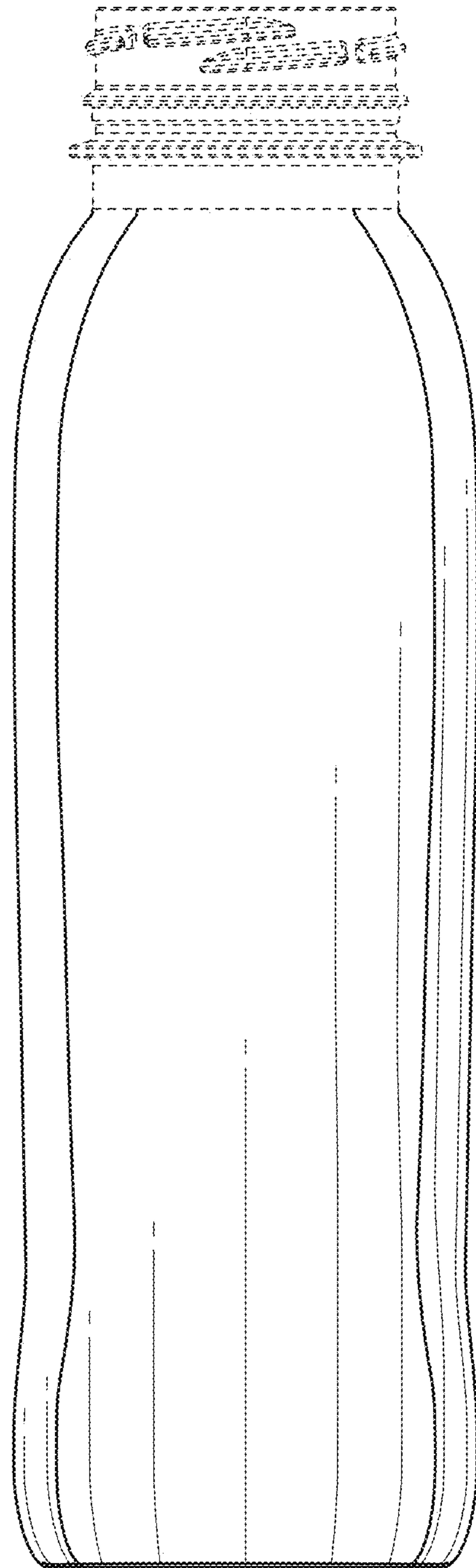

FIG. 3

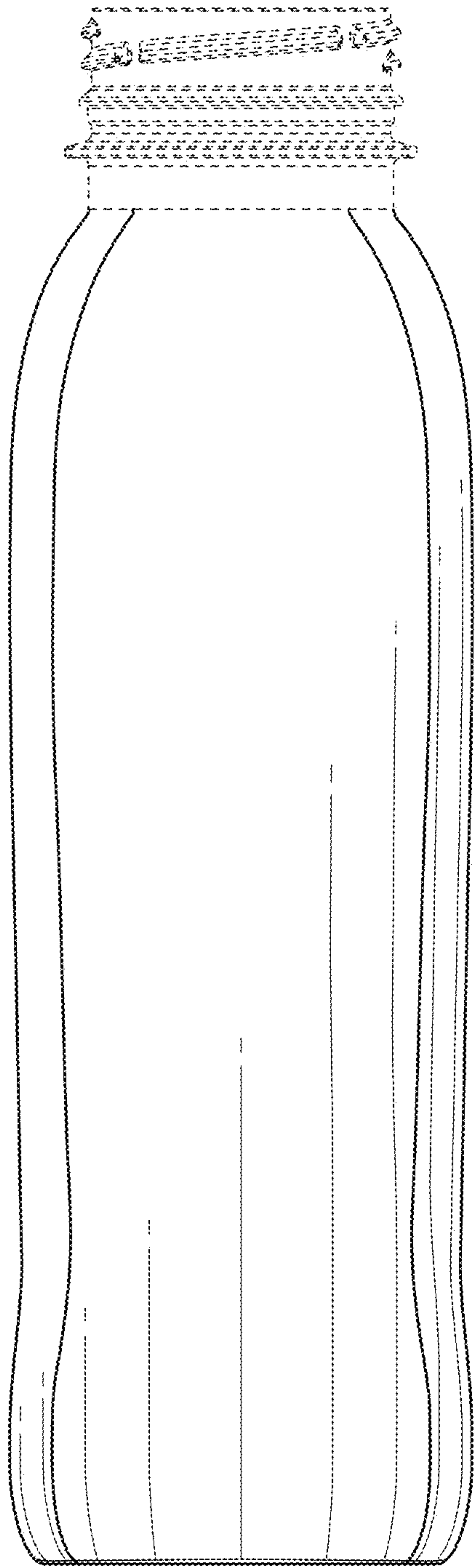

FIG. 4

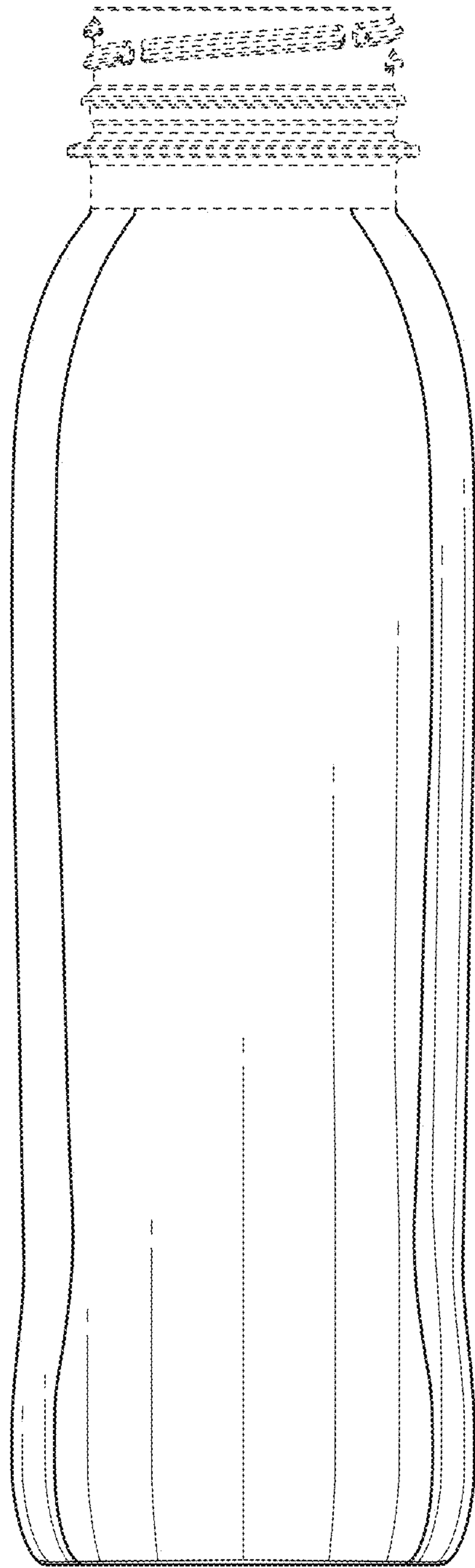

FIG. 5

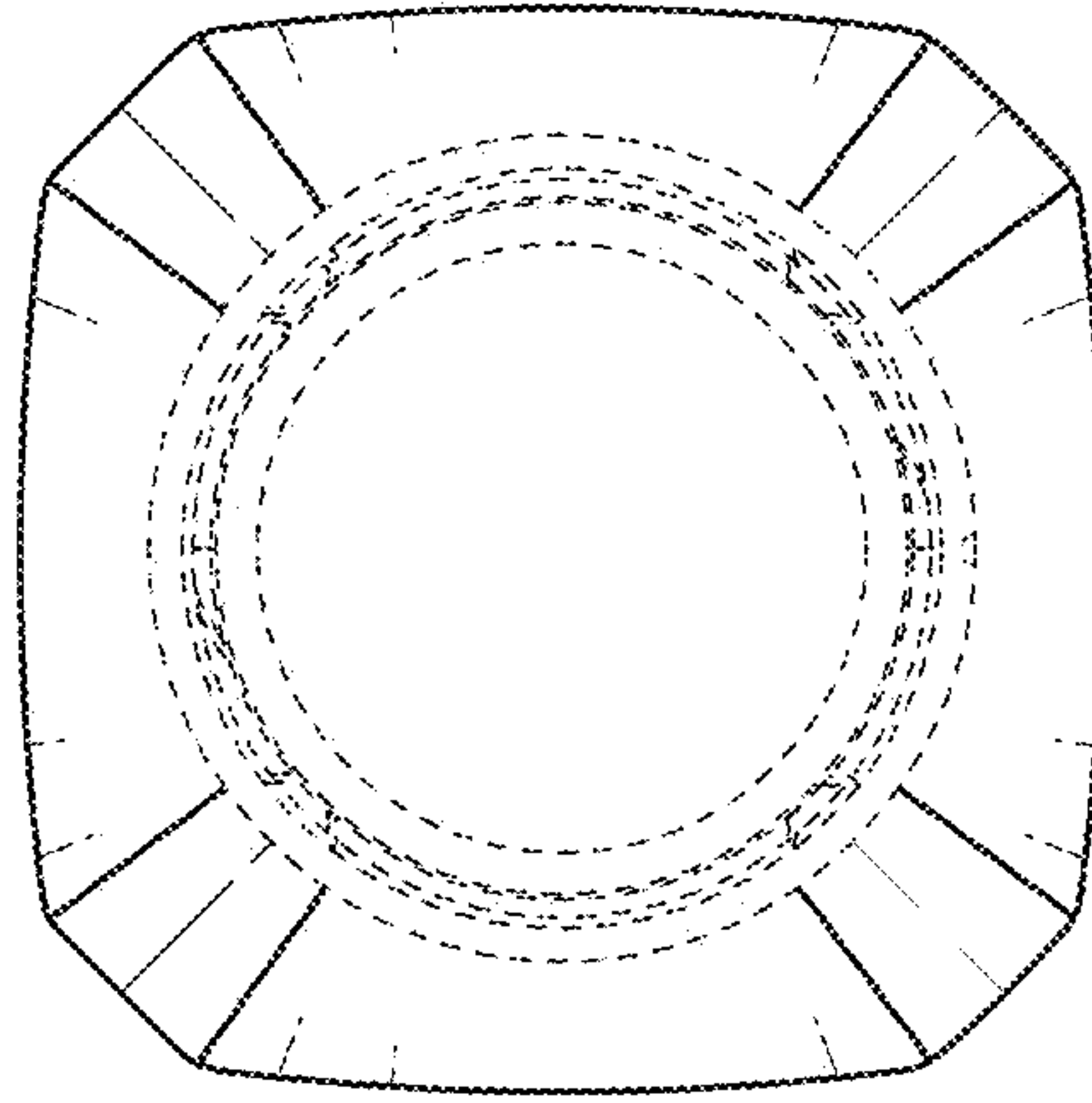

FIG. 6

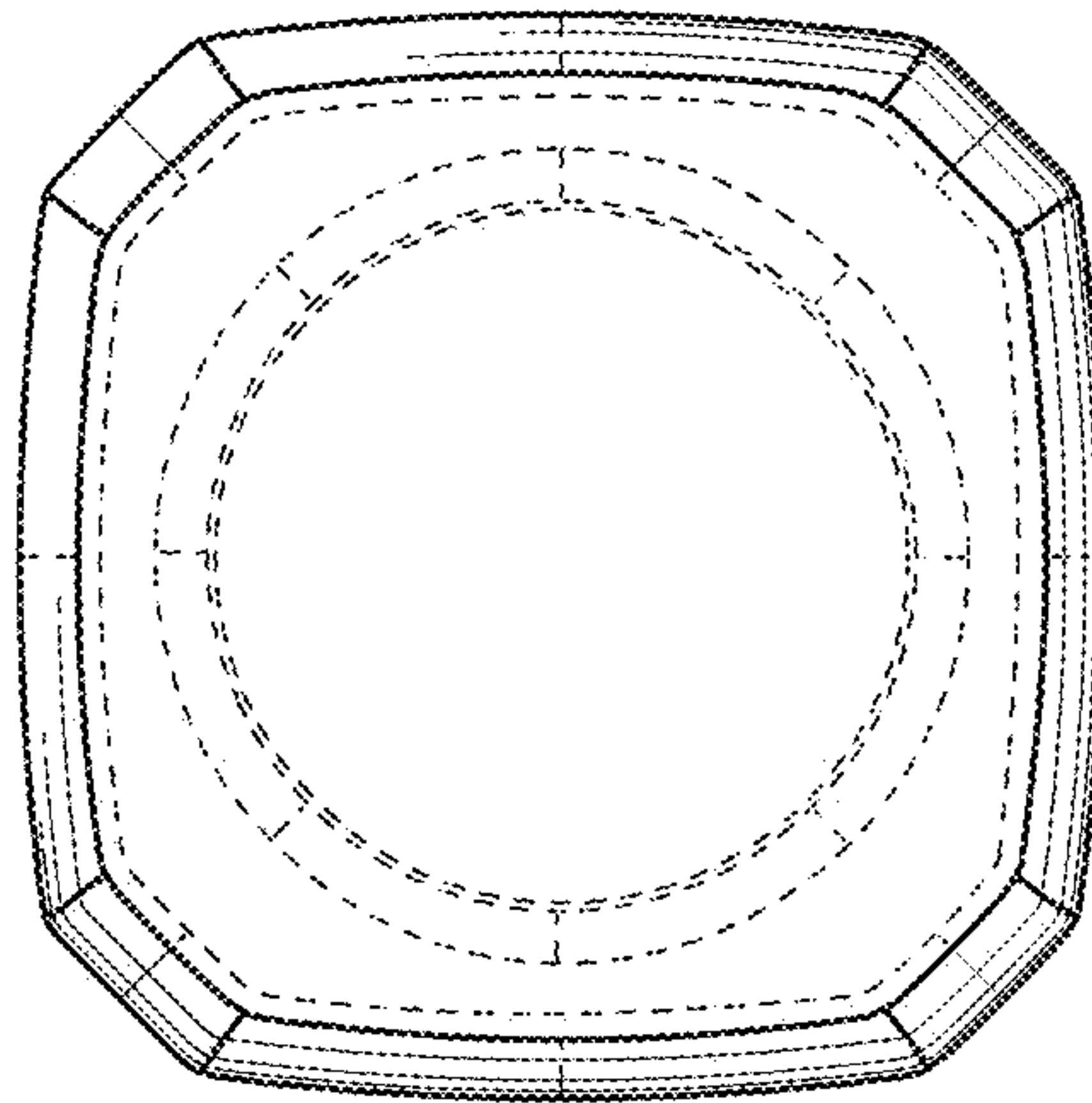

FIG. 7