



US00D925869S

(12) **United States Design Patent**
Davis et al.

(10) **Patent No.:** **US D925,869 S**
(45) **Date of Patent:** **** Jul. 27, 2021**

- (54) **BIB SCARF**
- (71) Applicant: **MAD Product Innovations LLC**,
Jacksonville Beach, FL (US)
- (72) Inventors: **Amanda Davis**, Jacksonville Beach, FL
(US); **Jessica Woodward Frantz**,
Jacksonville, FL (US)
- (73) Assignee: **MAD Product Innovations**, Neptune
Beach, FL (US)
- (**) Term: **15 Years**
- (21) Appl. No.: **29/654,511**
- (22) Filed: **Jun. 25, 2018**
- (51) **LOC (13) Cl.** **02-02**
- (52) **U.S. Cl.**
USPC **D2/861; D2/500**
- (58) **Field of Classification Search**
USPC D2/500–502, 860–861, 600; 2/91, 207
CPC A41B 13/10; A41D 23/00
See application file for complete search history.

(56) **References Cited**

U.S. PATENT DOCUMENTS

- 2,510,720 A * 6/1950 Siegel A41D 23/00
2/91
- 2,806,222 A * 9/1957 Carpenter A41D 23/00
2/91
- 4,654,897 A * 4/1987 Rosaen A41D 23/00
2/207
- 6,418,563 B1 * 7/2002 Turner A41B 11/00
2/16
- 6,611,960 B2 * 9/2003 Kim A41D 27/18
2/115
- D488,613 S * 4/2004 Easlick D2/600
- D569,079 S * 5/2008 Whong D2/502
- D602,228 S * 10/2009 Pritchett D2/502
- D699,018 S * 2/2014 Shehadeh D2/600
- D714,575 S * 10/2014 Mah D6/608
- D723,245 S * 3/2015 Womack D2/600
- D783,929 S * 4/2017 Padilla D2/501
- D818,245 S * 5/2018 Richardson D2/826
- D846,831 S * 4/2019 Greene D2/500

- 2011/0088133 A1* 4/2011 Cox A41B 13/106
2/49.1
- 2015/0289577 A1* 10/2015 Roffe A41D 23/00
2/207
- 2019/0059490 A1* 2/2019 Meadsavapanmonkol
A42B 1/041

OTHER PUBLICATIONS

Baby Bazel, posted 2019 [online], Retrieved from the internet, <https://weallsew.com/fabric-bow/>, https://www.google.com/shopping/product/17203058581306934530?q=MAD+Product+Innovations+LLC&bih=1057&biw=1920&rlz=1C1GCEB_enUS7%E2%80%A6#spf=1582816169756 (Year: 2019).*

DIY Fabric Bow Tutorial , posted 2016 [online], (retrieved Jun. 24, 2020). Retrieved from the internet, [//weallsew.com/fabric-bow/](https://weallsew.com/fabric-bow/) (Year: 2016).*

* cited by examiner

Primary Examiner — Kevin K Rudzinski

Assistant Examiner — J. Thorn, Sr.

(74) *Attorney, Agent, or Firm* — Lee & Hayes, P.C.

(57) **CLAIM**

The ornamental design for a bib scarf, as shown and described.

DESCRIPTION

FIG. 1 is a top perspective view of a first embodiment of a bib scarf in an open position.

FIG. 2 is a front elevation view of the first embodiment of the bib scarf the open position.

FIG. 3 is a back elevation view of the first embodiment of the bib scarf in the open position.

FIG. 4 is a left side elevation view of the first embodiment of the bib scarf in the open position.

FIG. 5 is a right side elevation view of the first embodiment of the bib scarf in the open position.

FIG. 6 is a top plan view of the first embodiment of the bib scarf in the open position.

FIG. 7 is a bottom plan view of the first embodiment of the bib scarf in the open position.

(Continued)

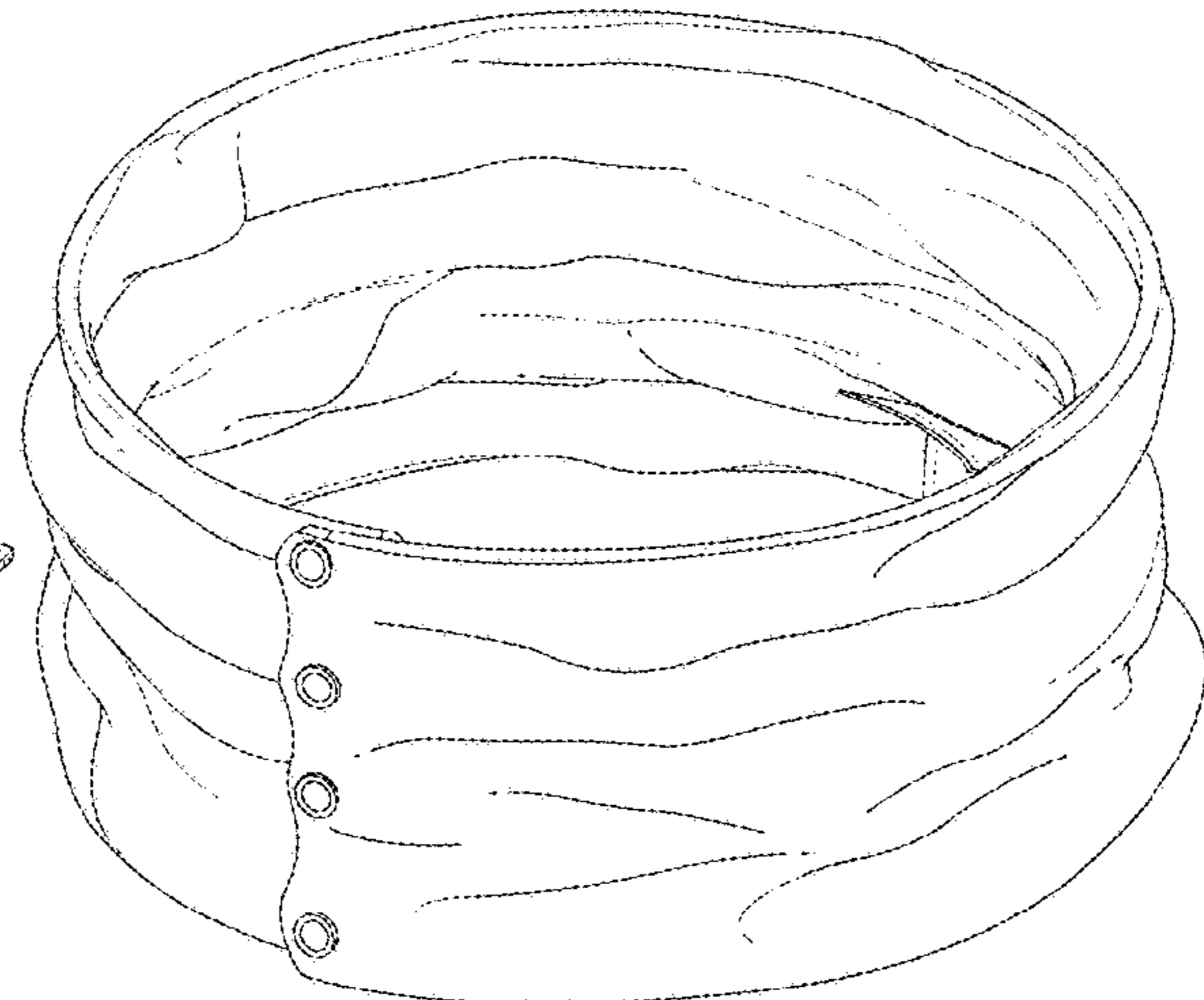
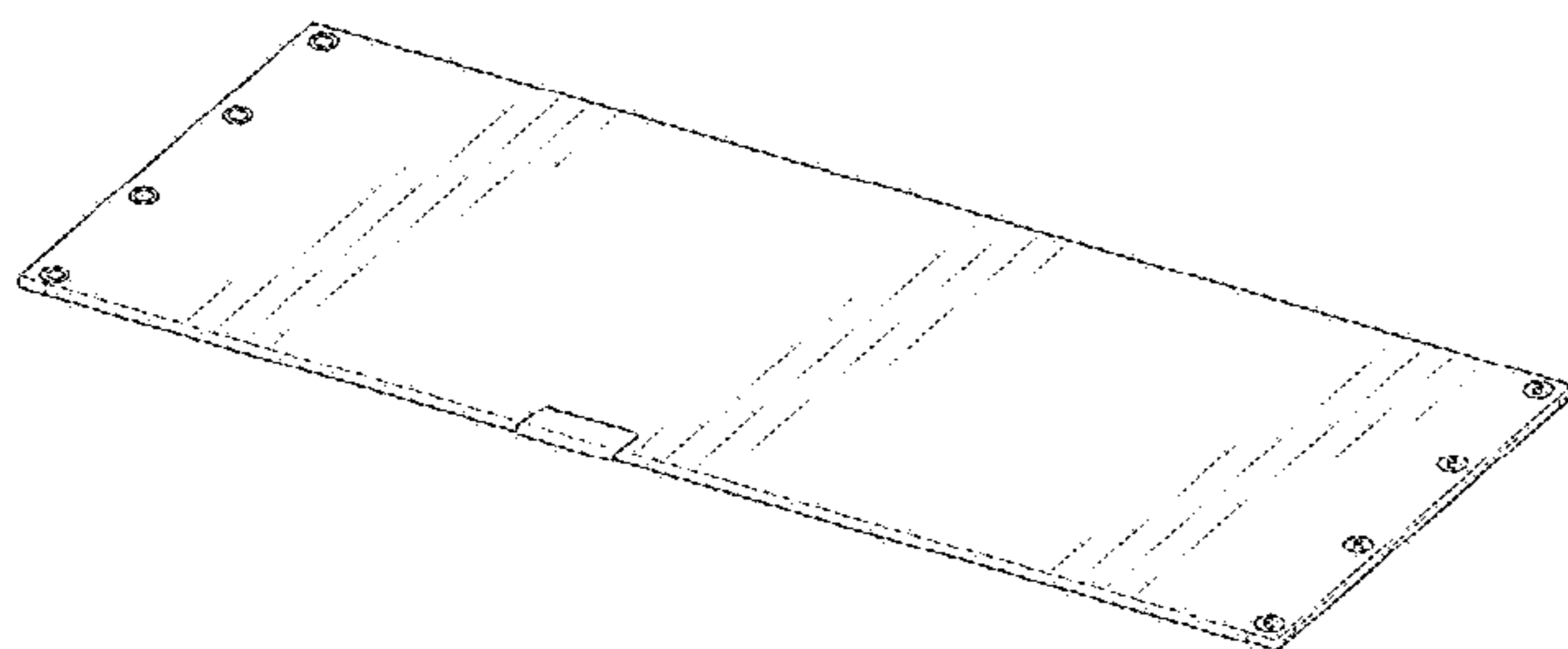

FIG. 8 is a perspective view of the first embodiment of the bib scarf in a closed position. The unclaimed tag illustrated in FIG. 8 lies flat in the open position but projects away from the bib scarf in the closed position.

FIG. 9 is a front elevation view of the first embodiment of the bib scarf in the closed position.

FIG. 10 is a back elevation view of the first embodiment of the bib scarf in the closed position.

FIG. 11 is a left side elevation view of the first embodiment of the bib scarf in the closed position.

FIG. 12 is a right side elevation view of the first embodiment of the bib scarf in the closed position.

FIG. 13 is a top plan view of the first embodiment of the bib scarf in the closed position.

FIG. 14 is a bottom plan view of the first embodiment of the bib scarf in the closed position.

FIG. 15 is a top perspective view of a second embodiment of a bib scarf in an open position.

FIG. 16 is a front elevation view of the second embodiment of the bib scarf the open position.

FIG. 17 is a back elevation view of the second embodiment of the bib scarf in the open position.

FIG. 18 is a left side elevation view of the second embodiment of the bib scarf in the open position.

FIG. 19 is a right side elevation view of the second embodiment of the bib scarf in the open position.

FIG. 20 is a top plan view of the second embodiment of the bib scarf in the open position.

FIG. 21 is a bottom plan view of the second embodiment of the bib scarf in the open position.

FIG. 22 is a perspective view of the second embodiment of the bib scarf in a closed position. The unclaimed tag illustrated in FIG. 22 lies flat in the open position but projects away from the bib scarf in the closed position.

FIG. 23 is a front elevation view of the second embodiment of the bib scarf in the closed position.

FIG. 24 is a back elevation view of the second embodiment of the bib scarf in the closed position.

FIG. 25 is a left side elevation view of the second embodiment of the bib scarf in the closed position.

FIG. 26 is a right side elevation view of the second embodiment of the bib scarf in the closed position.

FIG. 27 is a top plan view of the second embodiment of the bib scarf in the closed position.

FIG. 28 is a bottom plan view of the second embodiment of the bib scarf in the closed position; and,

FIG. 29 is a perspective view of the second embodiment of the bib scarf in the closed position, as worn by a subject. The broken lines showing the subject in FIG. 29 represent environment and form no part of the claimed design.

The broken lines shown as large dashed lines represent stitching seams of the bib scarf that form no part of the claimed design.

The broken lines shown as small dashed lines represent portions of the bib scarf that form no part of the claimed design.

1 Claim, 25 Drawing Sheets

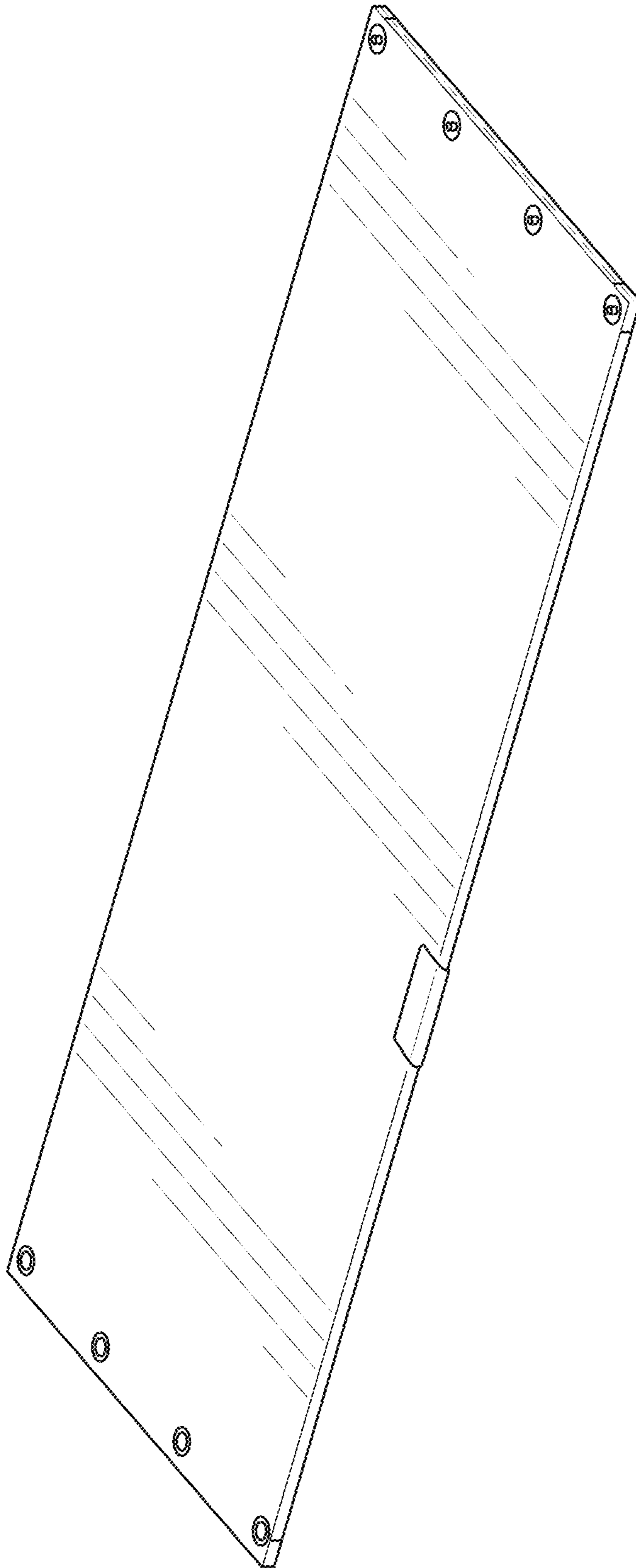

FIG. 1



FIG. 2

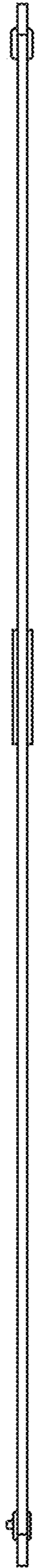

FIG. 3



FIG. 4



FIG. 5

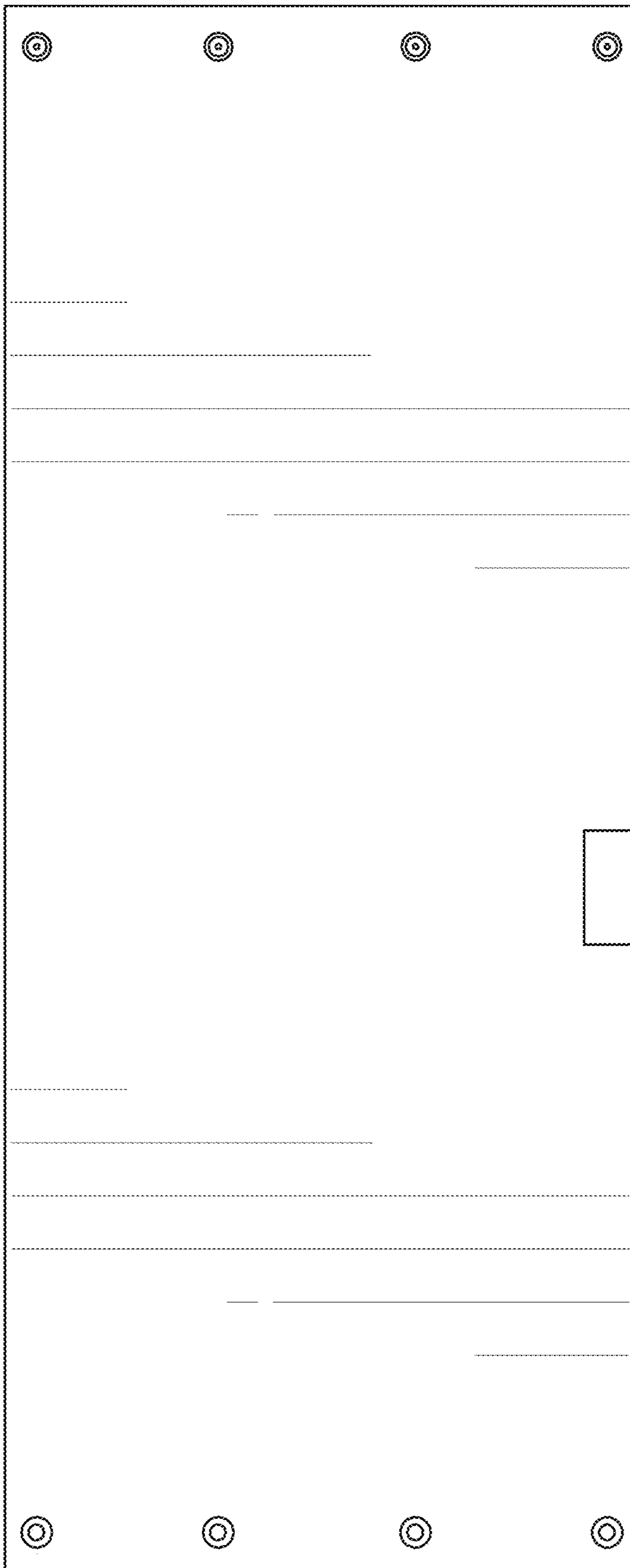

FIG. 6

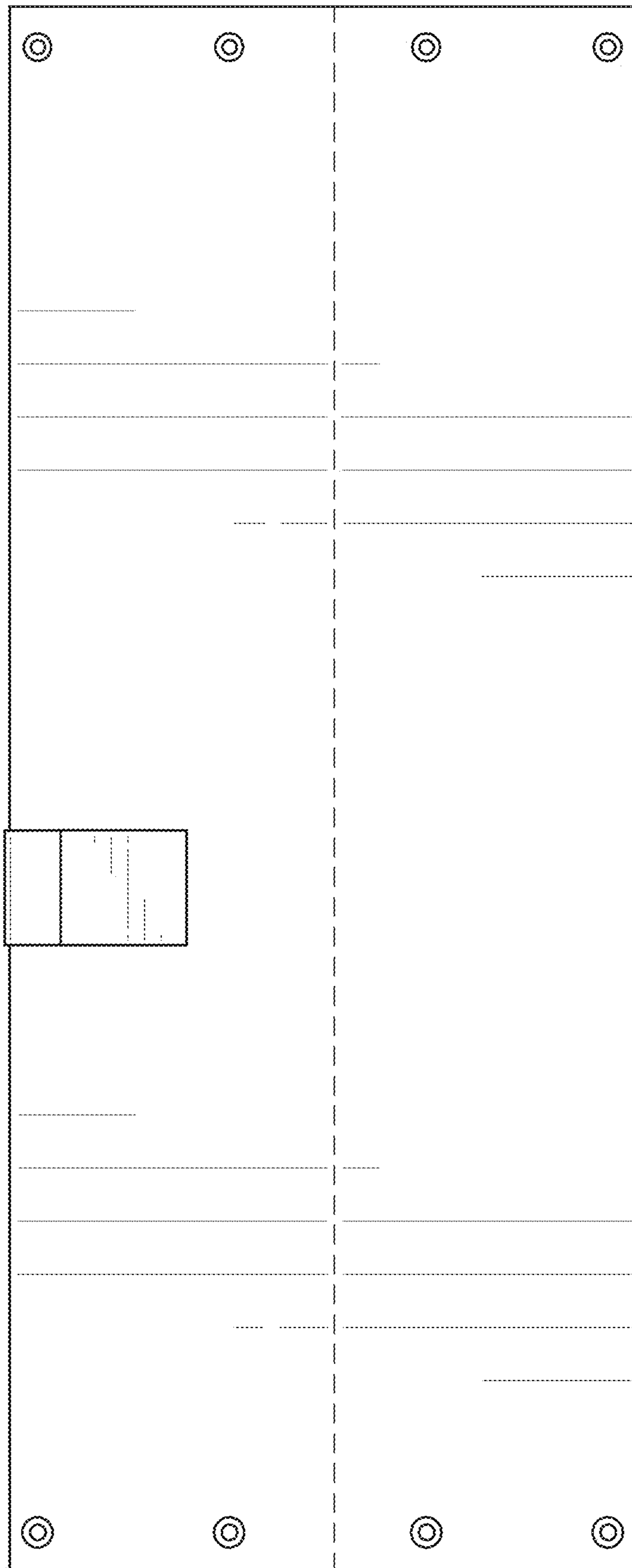

FIG. 7

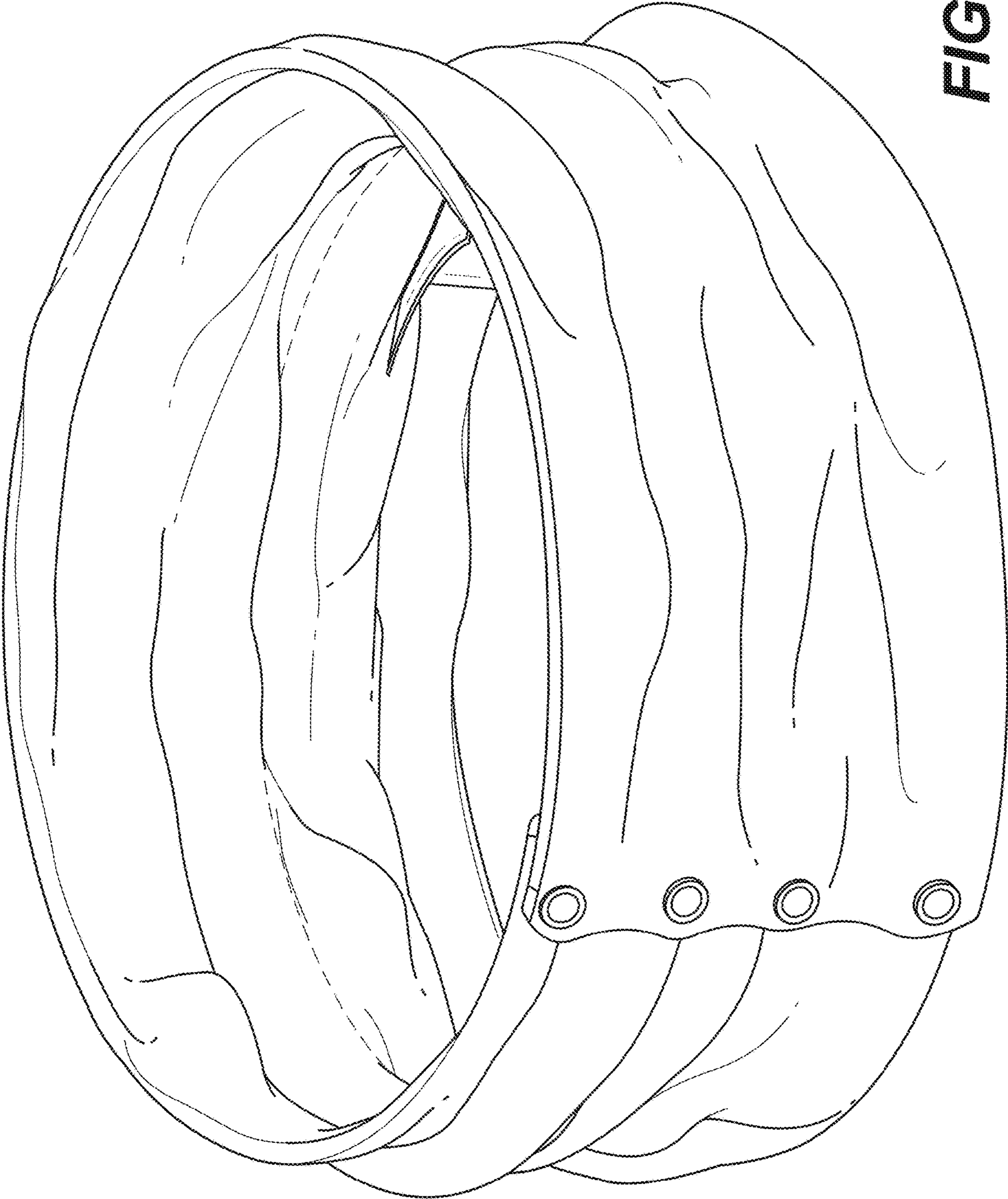

FIG. 8

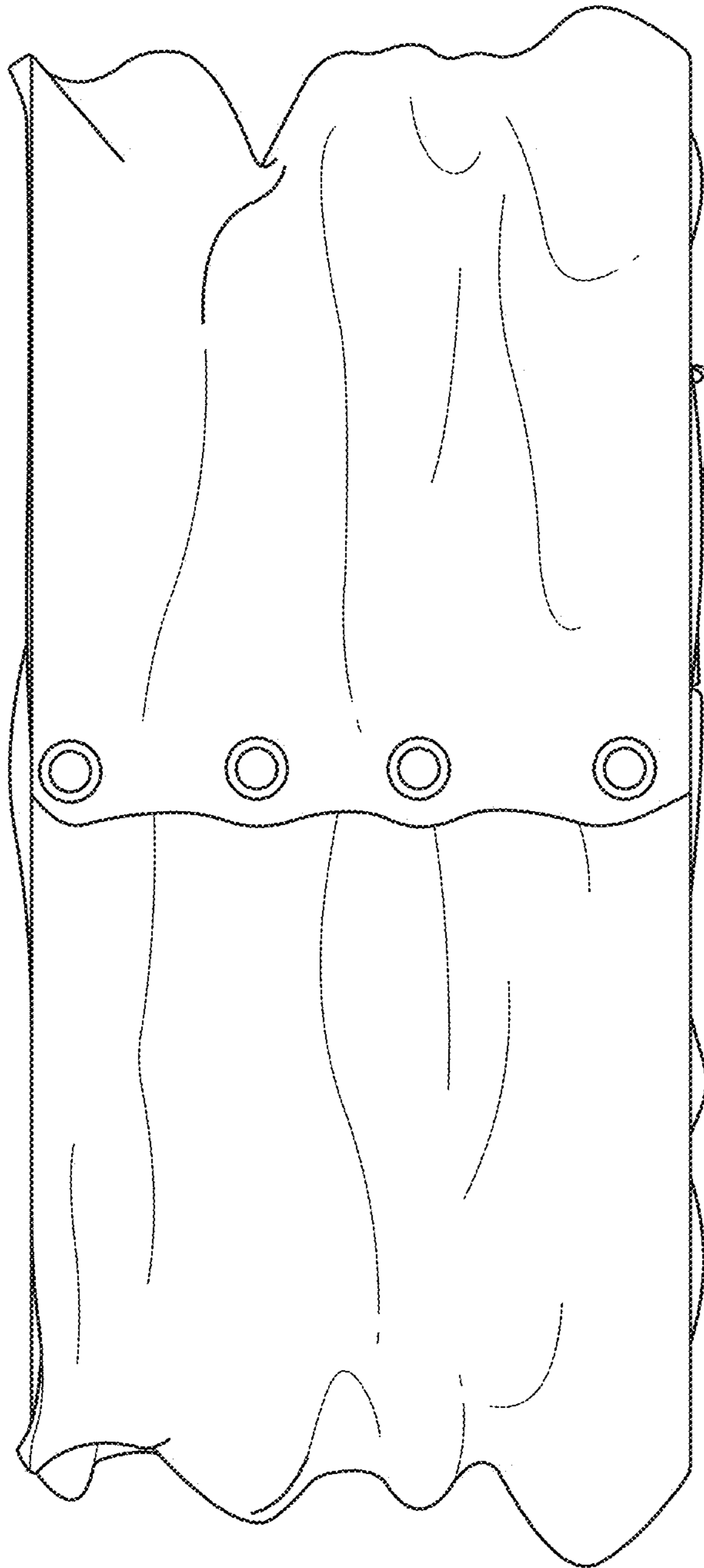

FIG. 9



FIG. 10



FIG. 11

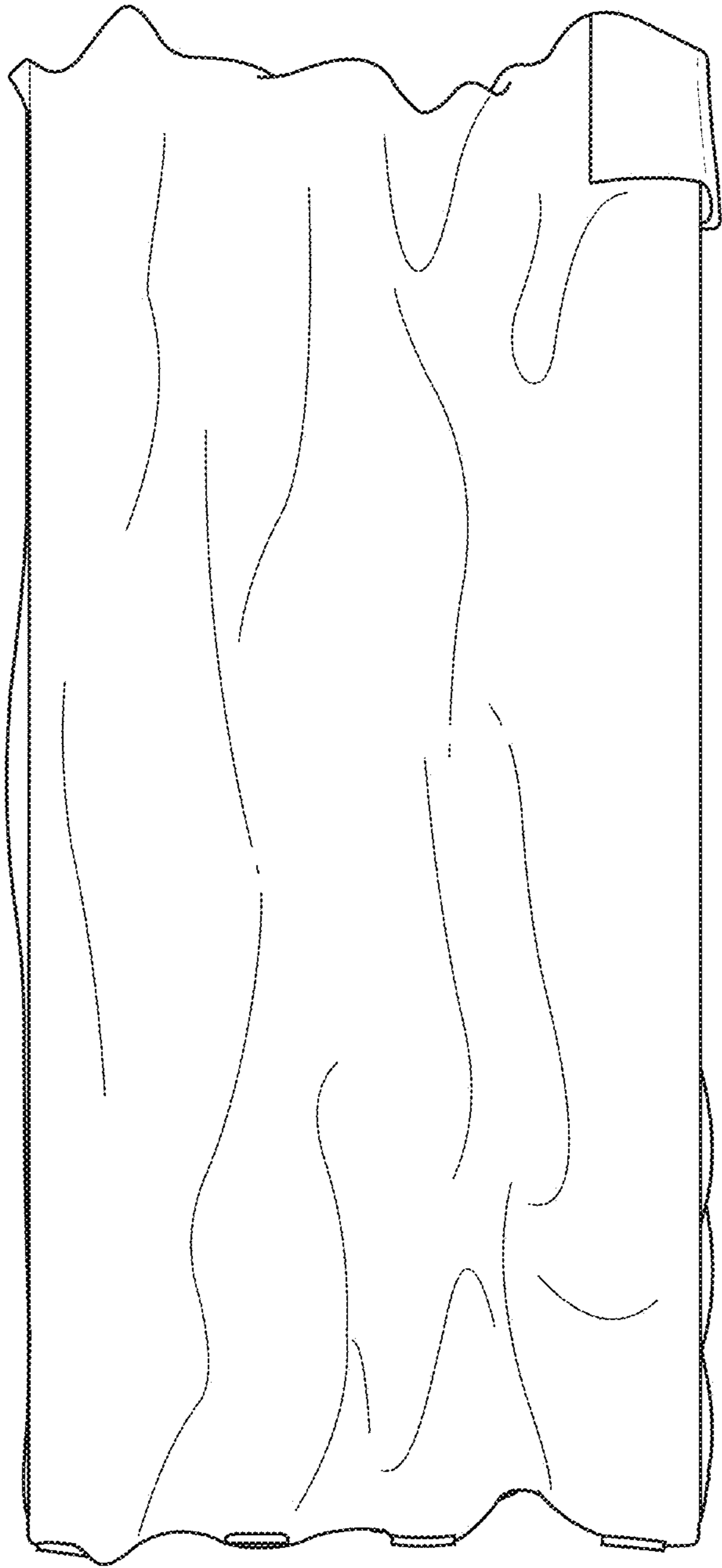

FIG. 12

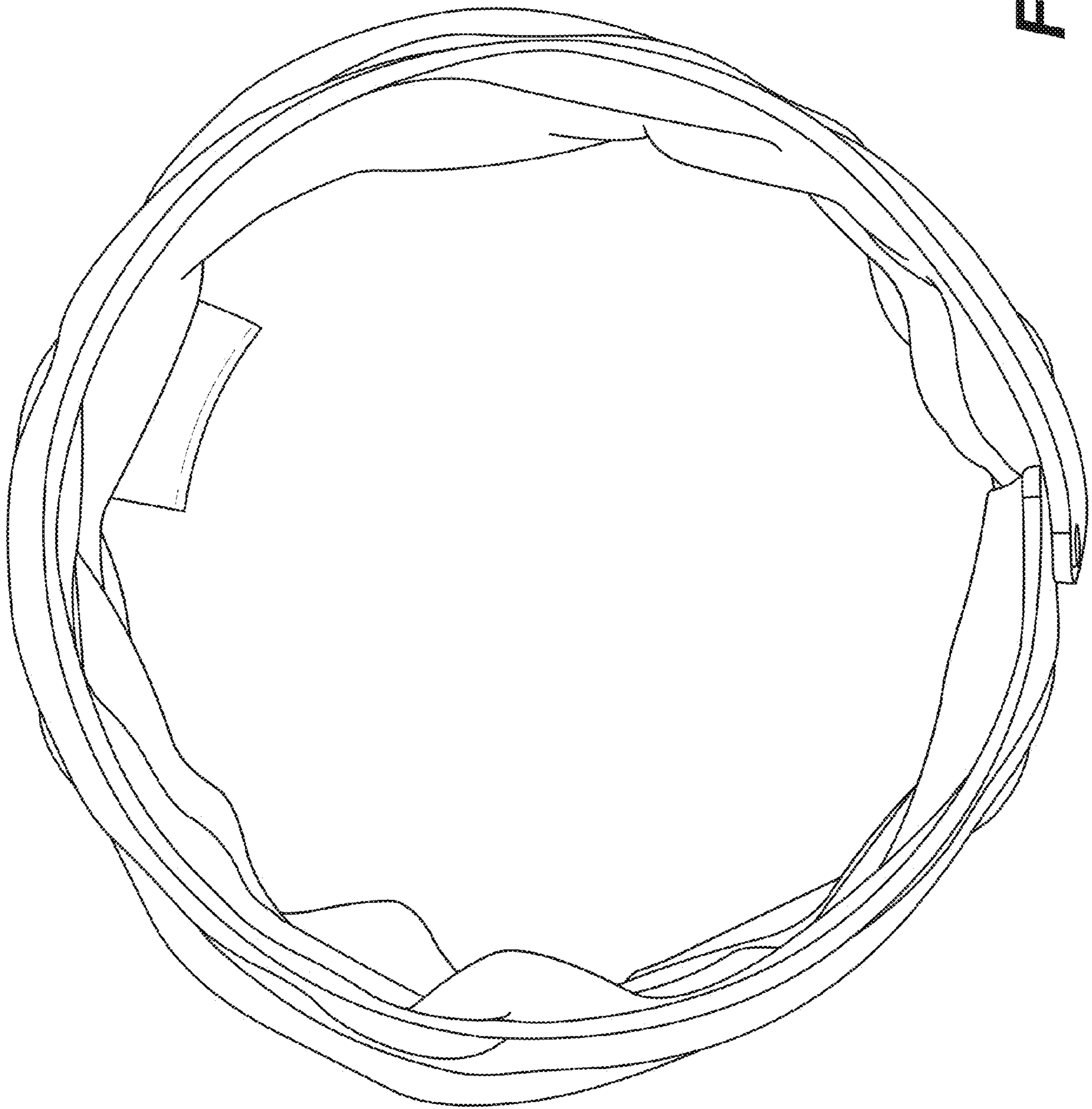

FIG. 13

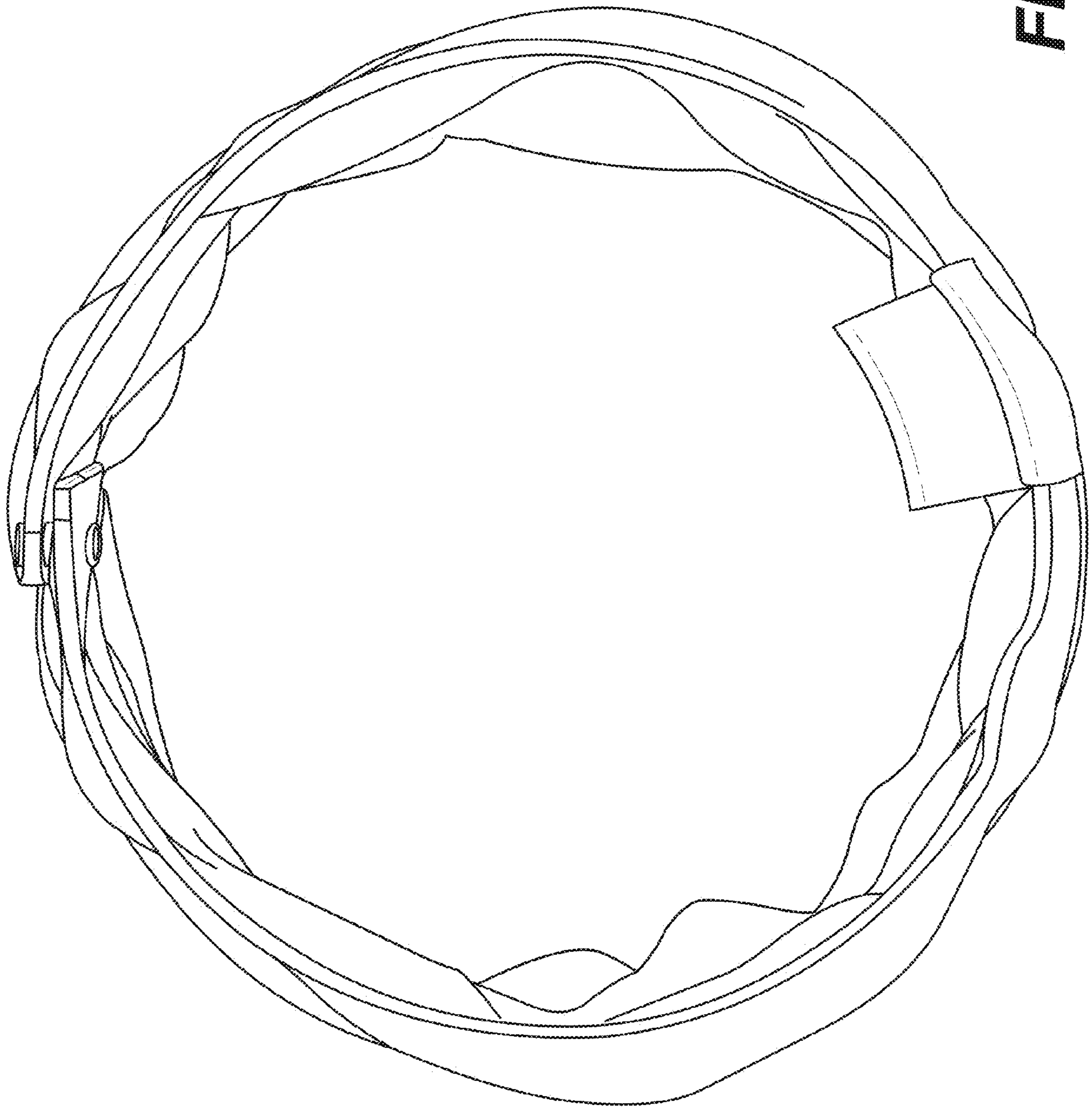

FIG. 14

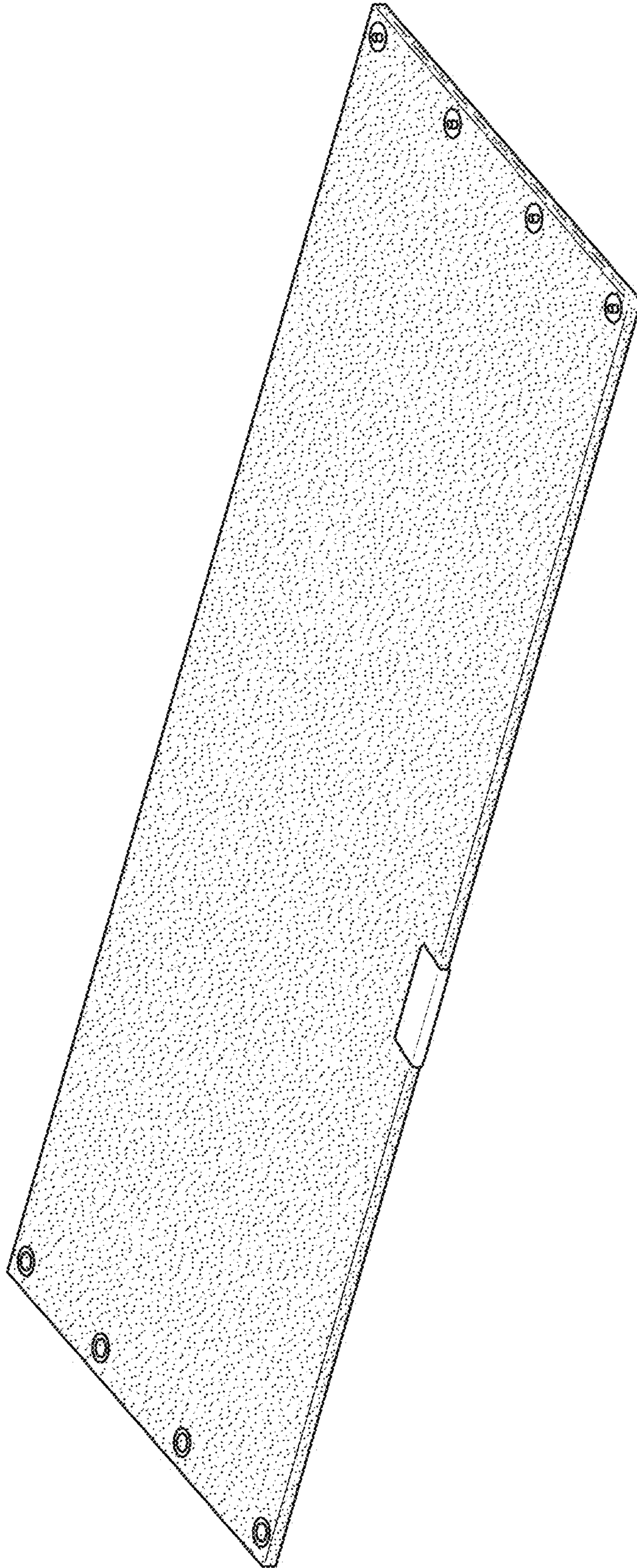

FIG. 15

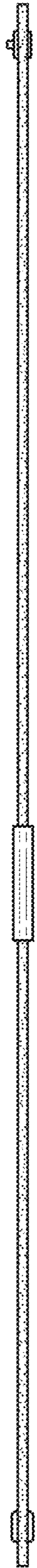

FIG. 16



FIG. 17



FIG. 18



FIG. 19

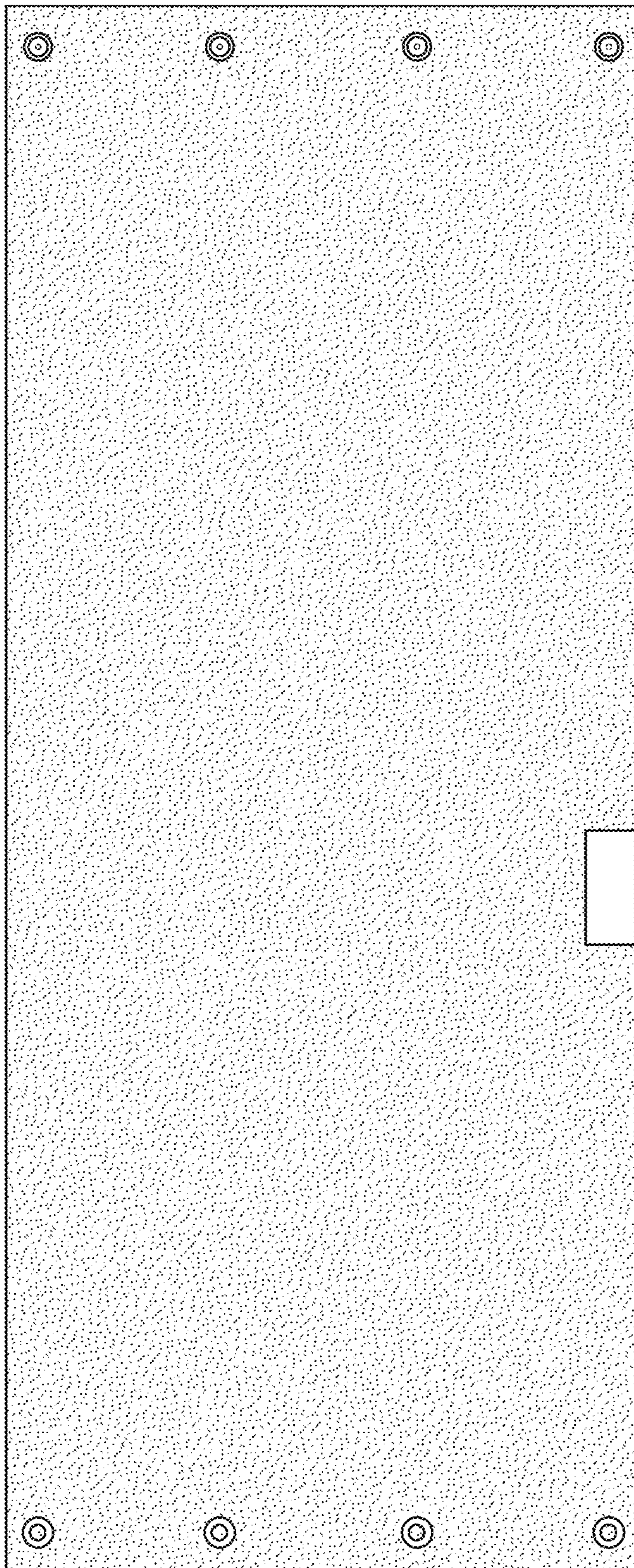

FIG. 20

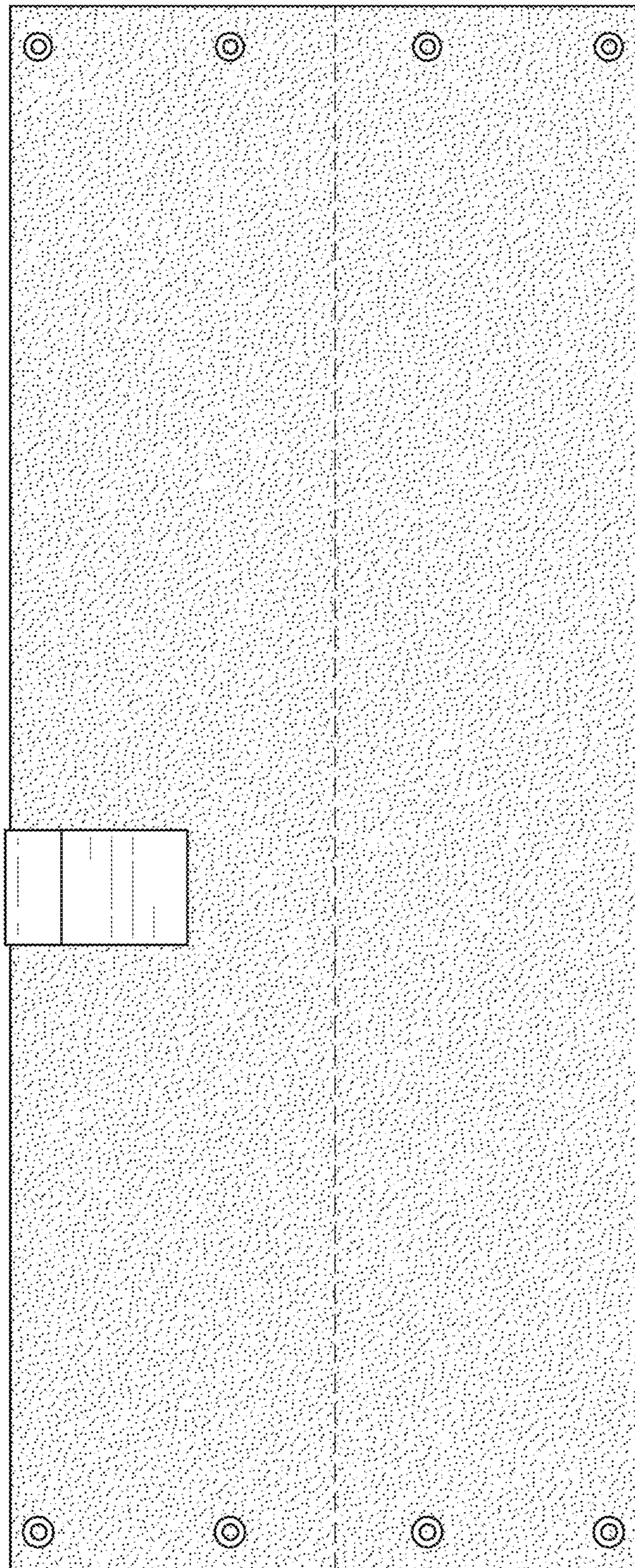

FIG. 21

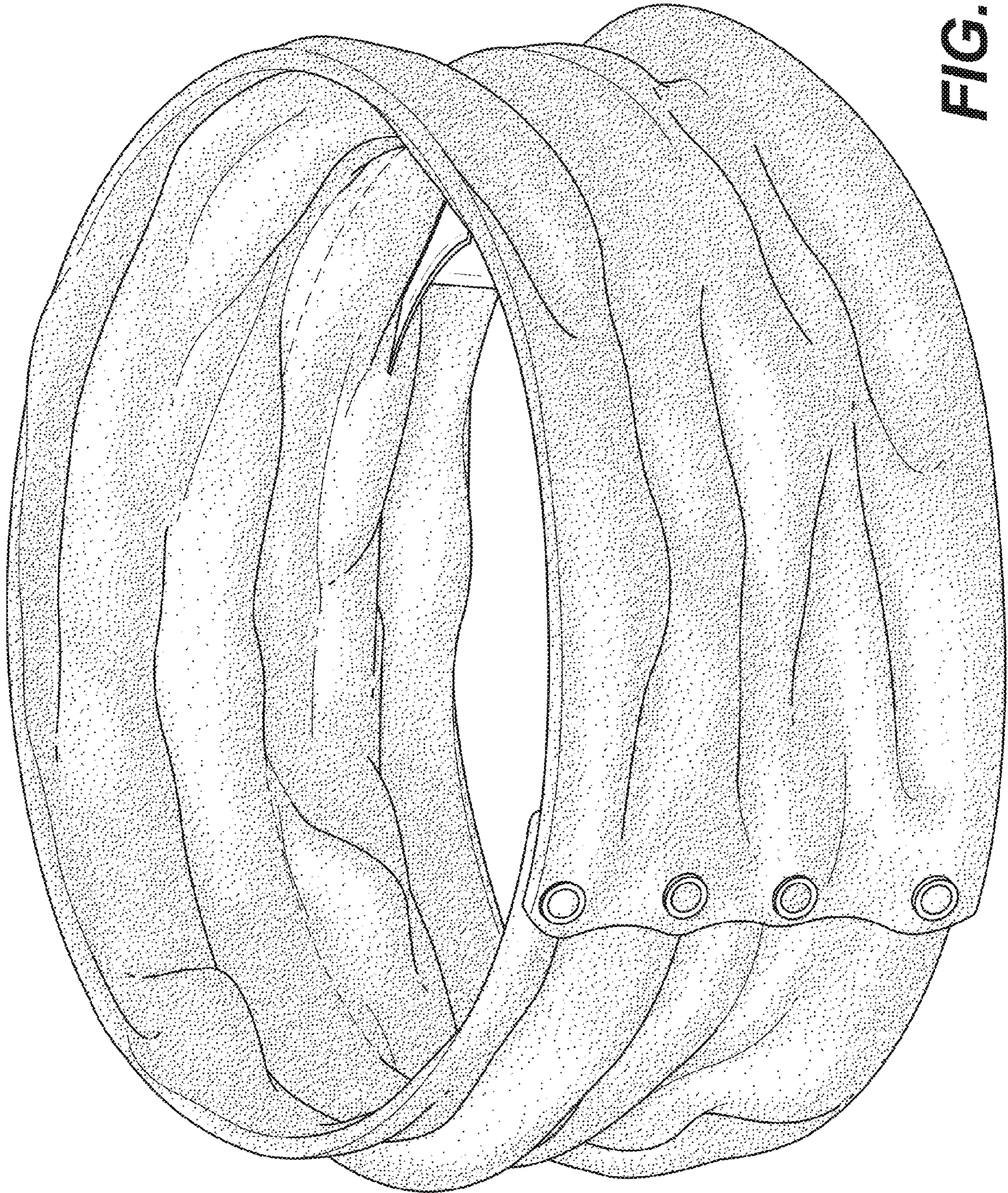

FIG. 22

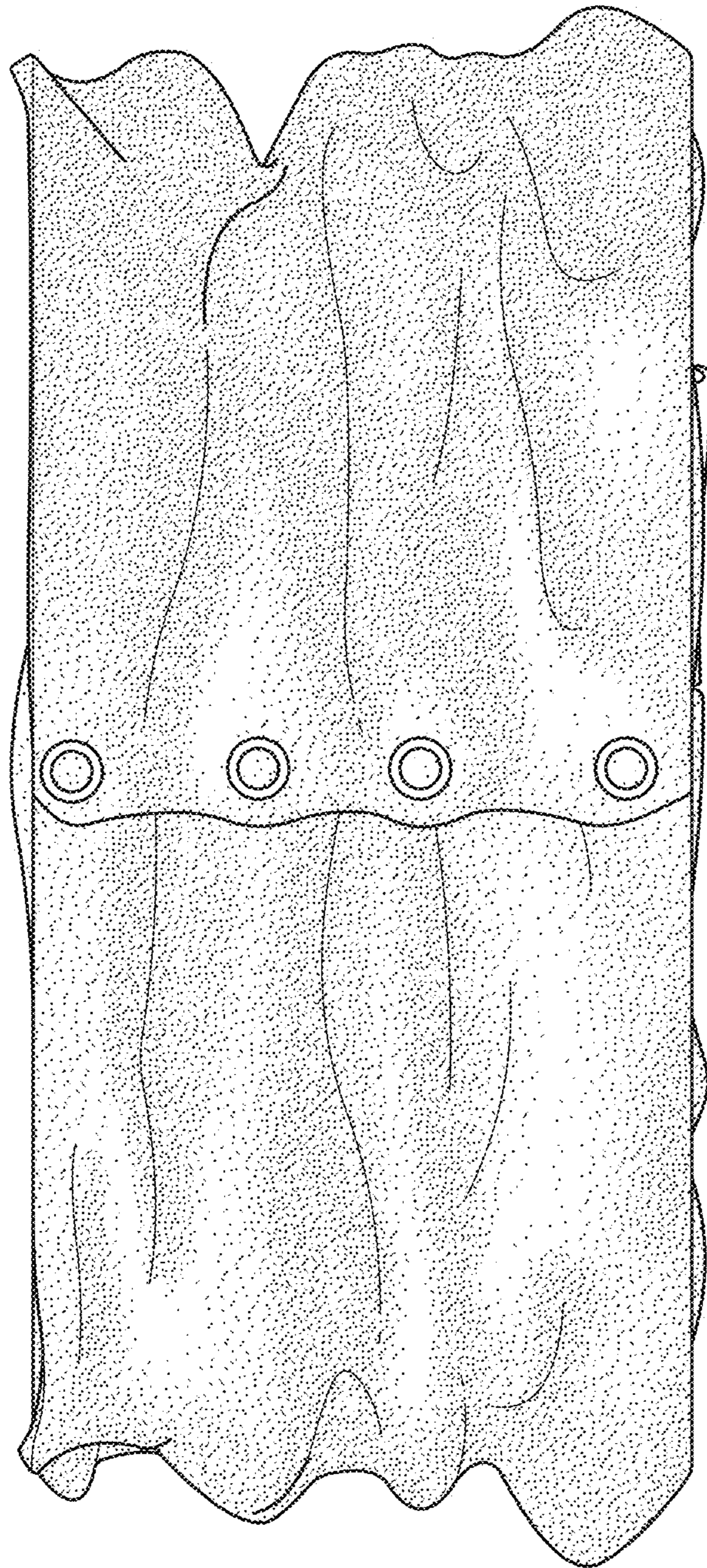

FIG. 23

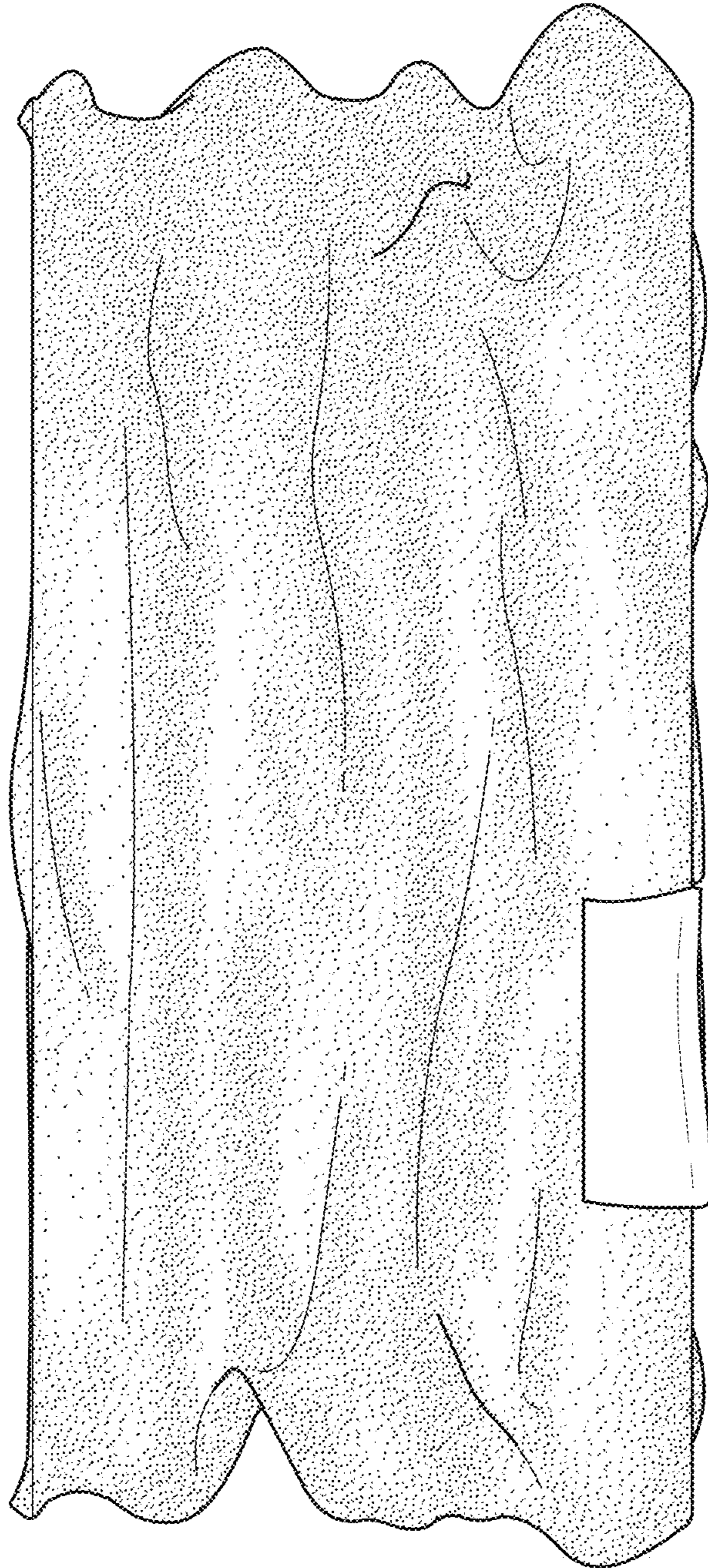

FIG. 24

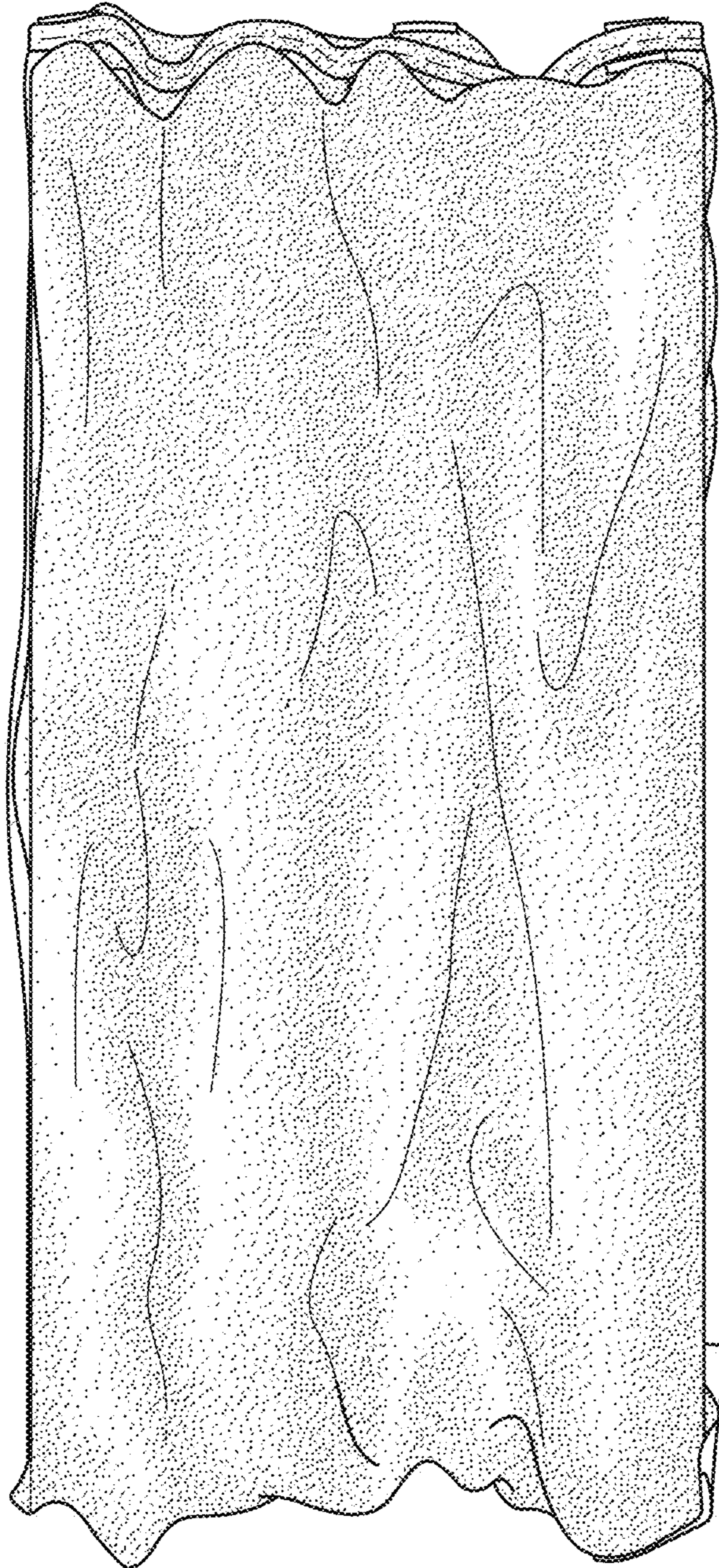

FIG. 25

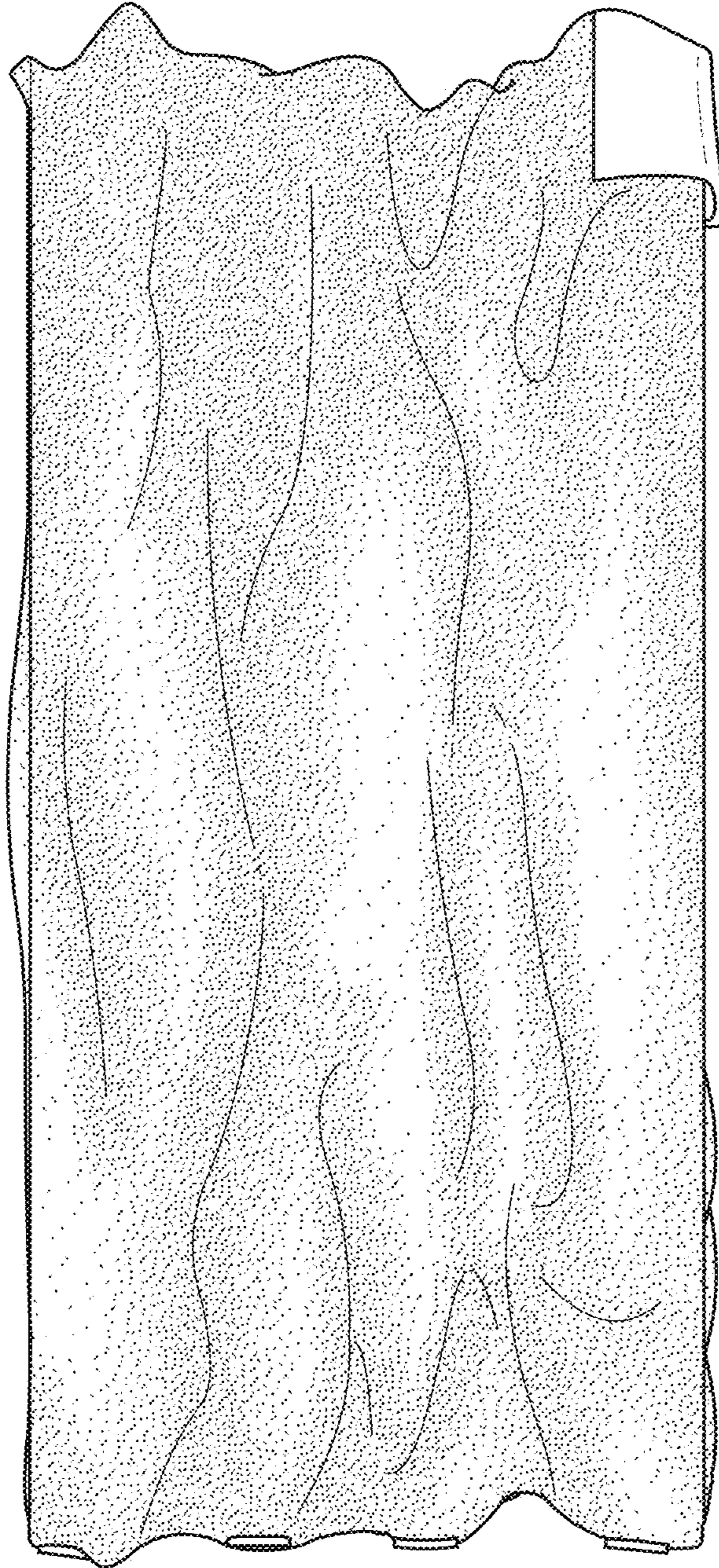

FIG. 26

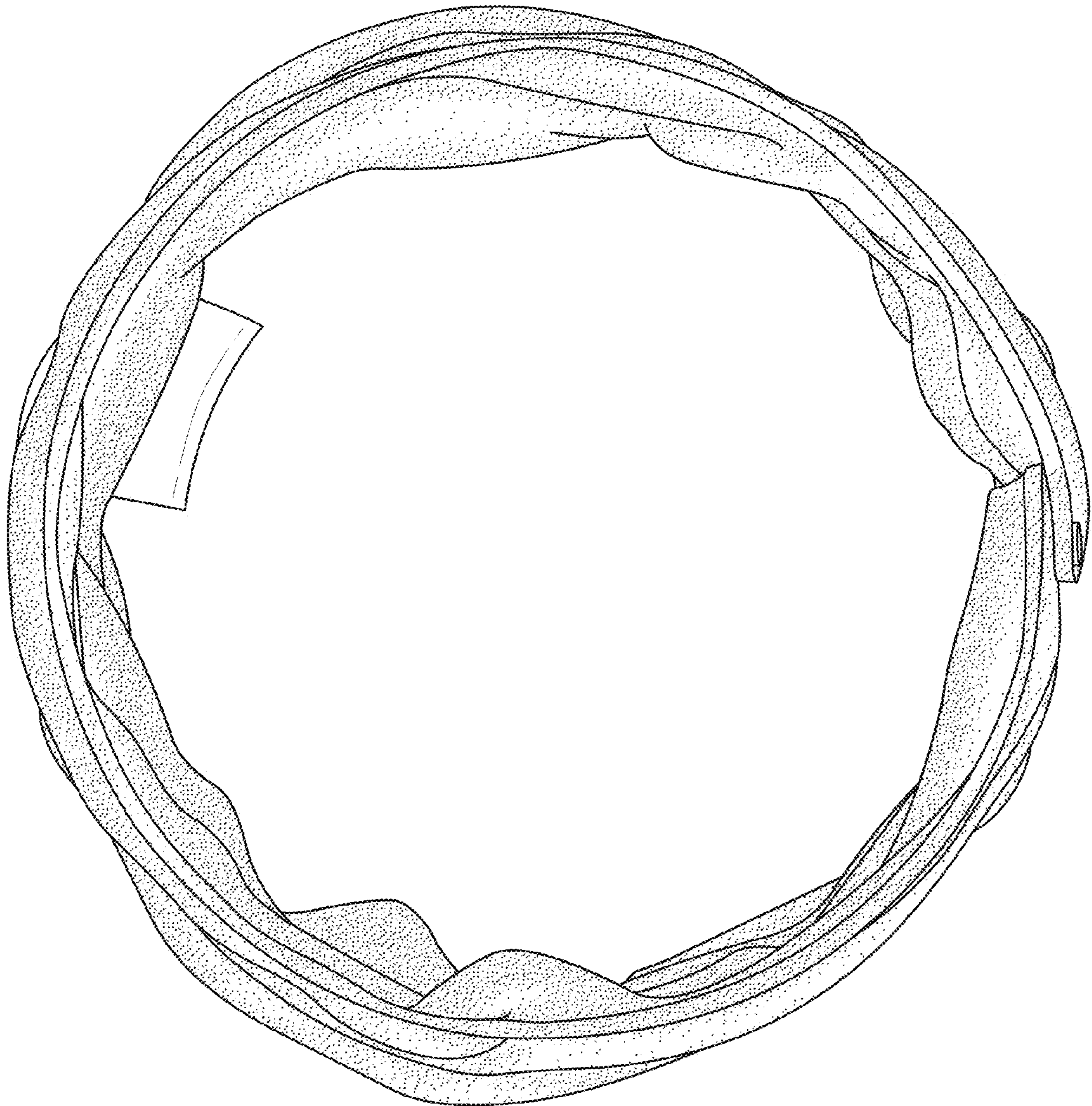

FIG. 27

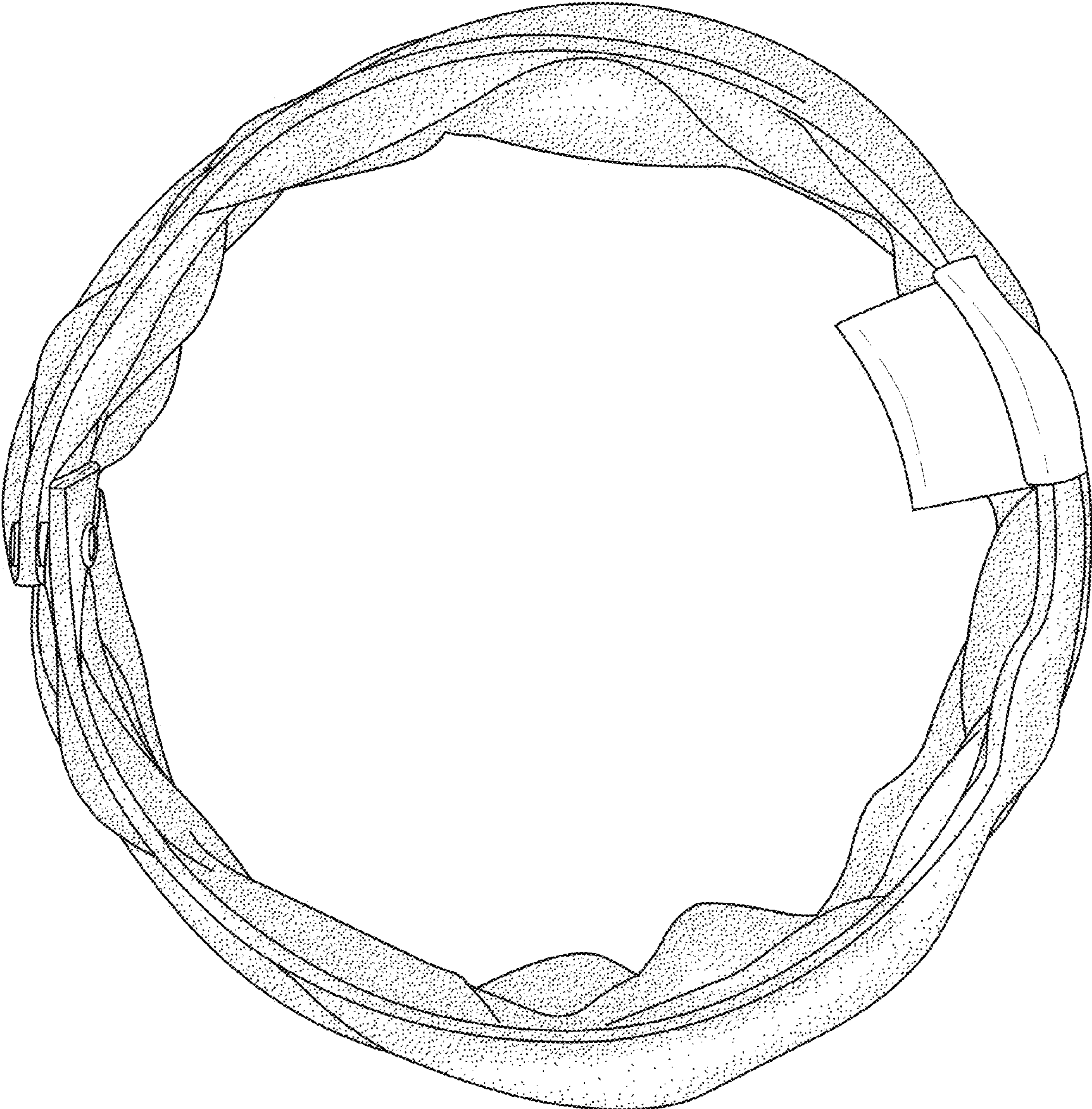

FIG. 28

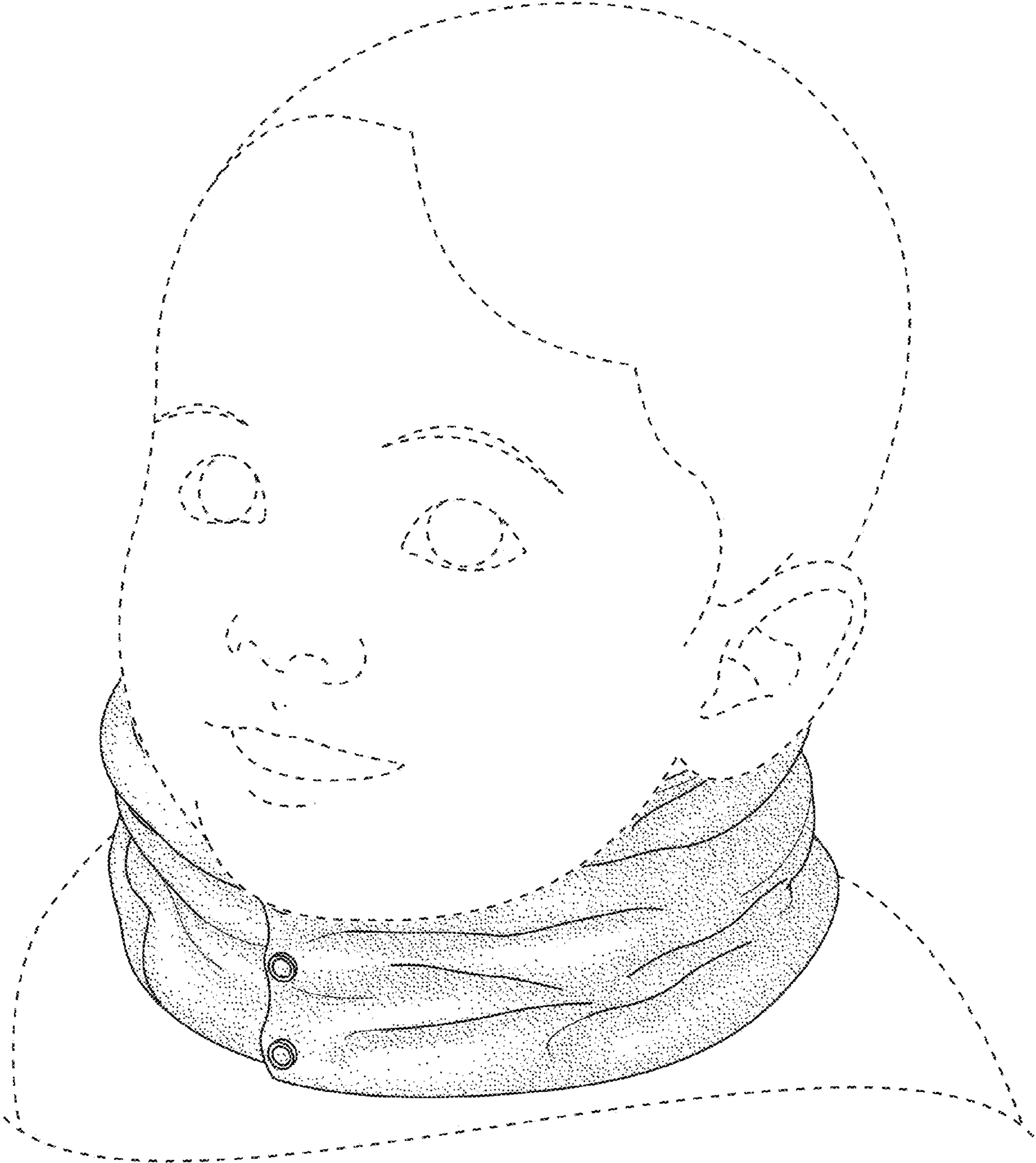

FIG. 29