



US00D925847S

(12) **United States Design Patent** (10) **Patent No.:** **US D925,847 S**
Xia (45) **Date of Patent:** **** Jul. 20, 2021**

(54) **HANDHELD VACUUM CLEANER**

FOREIGN PATENT DOCUMENTS

(71) Applicant: **Jingwei Xia**, Meizhou (CN)

JP D1679657 * 2/2021

(72) Inventor: **Jingwei Xia**, Meizhou (CN)

OTHER PUBLICATIONS

(**) Term: **15 Years**

(21) Appl. No.: **29/731,688**

(22) Filed: **Apr. 17, 2020**

(51) **LOC (13) Cl.** **15-05**

(52) **U.S. Cl.**
USPC **D32/18**

(58) **Field of Classification Search**
USPC D32/17, 18, 21, 22, 23, 24, 31; D21/526
CPC A46B 9/06; A47L 5/24; A47L 5/28; A47L
5/30; A47L 5/34; A47L 7/0004; A47L
9/04; A47L 9/325; A47L 9/1683; A47L
11/302; A47L 11/34; A47L 11/4005;
A47L 11/4008; A47L 11/4016; A47L
11/4041; A47L 11/4044; A47L 11/4088;
A47L 13/225; B04C 5/185; B08B 3/04;
B23Q 11/0046; B23Q 11/0071; E04H
4/1636

See application file for complete search history.

Audew Handheld Vacuum, available Amazon.ca, date available Mar. 18, 2021 [online], [site visited May 17, 2021], Available internet URL: https://www.amazon.ca/Handheld-Cordless-Powerful-Rechargeable-Lightweight/dp/B08R8VH6CH/ref=sr_1_5?dchild=1&keywords=AUDEW+Handheld+Vacuum+Cordless%2C&qid=1621352582&sr=8-5 (Year: 2021).*

Handheld Lightweight Vacuum Cleaner Cordless, available in Amazon.co.uk, date first available Sep. 21, 2020 [online], [site visited May 17, 2021], Available from the internet URL: https://www.amazon.co.uk/dp/B08T1SR59C/ref=cm_sw_em_r_mt_imm_awdb_279XJ3NWAGG1V9NN8MKM?_encoding=UTF8&psc=1 (Year: 2020).*

(Continued)

Primary Examiner — Dana K Weiland
Assistant Examiner — Jennylou M Binas

(56) **References Cited**

U.S. PATENT DOCUMENTS

D176,422 S *	12/1955	Madl	D32/18
D303,856 S *	10/1989	Yuen	D32/18
D314,650 S *	2/1991	Pudwill	D32/18
D543,667 S *	5/2007	Yoshimoto	D32/18
D709,734 S *	7/2014	Kotani	D7/608
D743,125 S *	11/2015	Lee	D32/22
D785,260 S *	4/2017	Lin	D32/31
D812,829 S *	3/2018	Shin	D06F 87/00
				D32/25
D818,004 S *	5/2018	Lee	D15/7
D873,516 S *	1/2020	Palladino	D32/32
D891,014 S *	7/2020	Chu	D32/18
D911,641 S *	2/2021	Hu	D32/18
2019/0328188 A1 *	10/2019	Conrad	A47L 9/1608

(57) **CLAIM**

The ornamental design for a handheld vacuum cleaner, as shown and described.

DESCRIPTION

FIG. 1 is a perspective view of a handheld vacuum cleaner showing my new design;
FIG. 2 is another perspective view thereof;
FIG. 3 is a left side elevational view thereof
FIG. 4 is a front elevational view thereof;
FIG. 5 is a right side elevational view thereof;
FIG. 6 is a rear elevational view thereof;
FIG. 7 is a top plan view thereof; and,
FIG. 8 is a bottom plan view thereof.

1 Claim, 8 Drawing Sheets

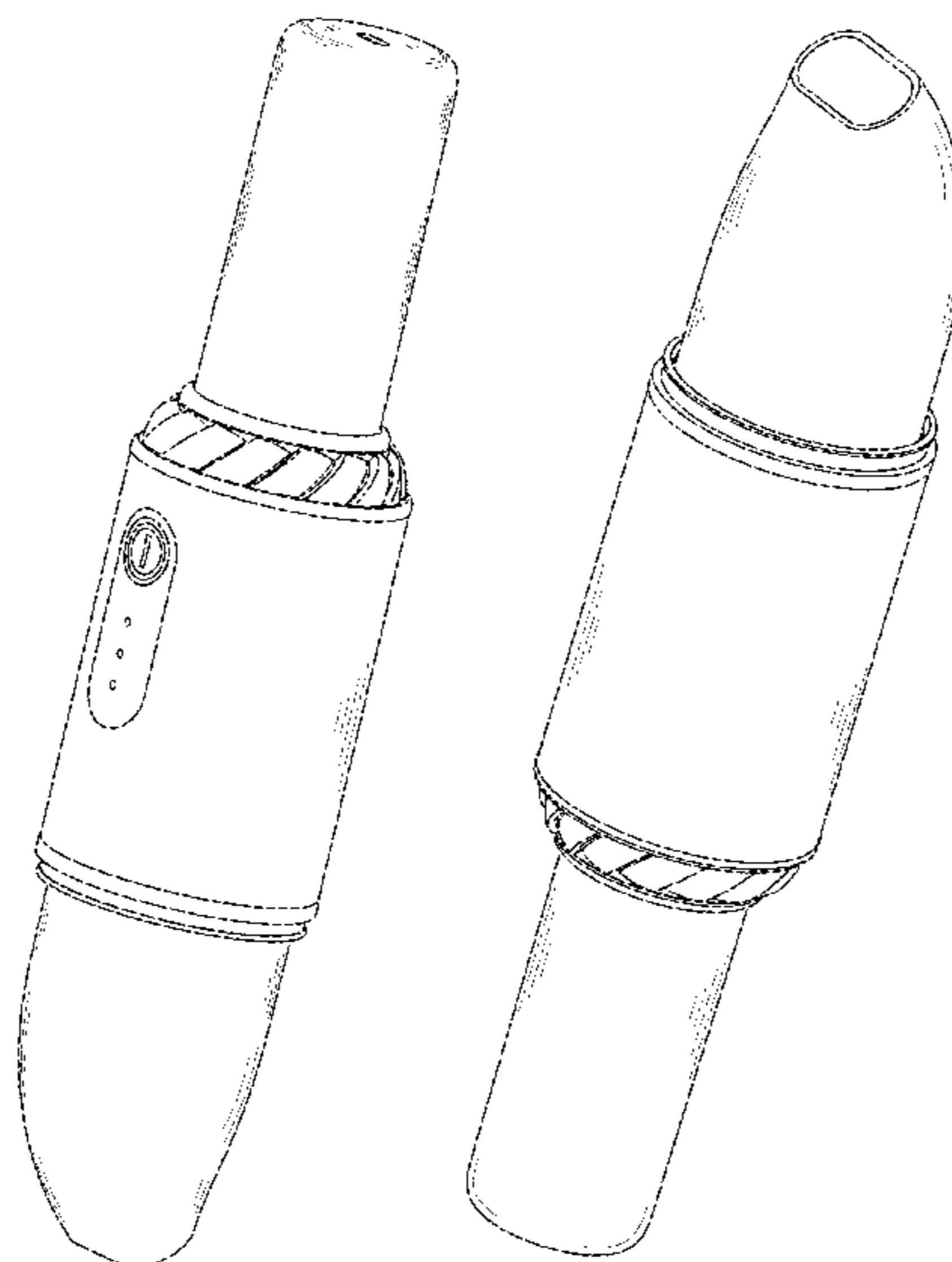

(56)

References Cited

OTHER PUBLICATIONS

SUMEI Rechargeable Keyboard Vacuum Cleaner Cordless, available in Amazon.co.uk, date first available Jul. 25, 2020 [online], [site visited May 17, 2021], Available from the internet . . . (Year: 2020) https://www.amazon.co.uk/SUMEI-Rechargeable-Keyboard-Cordless-Powerful/dp/B08BZD395L/ref=sr_1_3?dchild=1&keywords=SUMEI+Rechargeable+Keyboard+Vacuum+Cleaner+Cordless&qid=1621352357&s=kitchen&sr=1-3 (Year: 2020).*

BISSELL AeroSlim Lithium Ion Cordless Handheld Vacuum, available in Amazon.ca, date first available Jun. 22, 2020 [online], [site visited May 17, 2021], Available from the internet . . . (Year: 2020) URL: https://www.amazon.ca/BISSELL-AeroSlim-Cordless-Handheld-29869/dp/B087HQRW2M/ref=sr_1_94?dchild=1&keywords=cordless+handheld+vacuum+cleaner&qid=1621445668&sr=8-94 (Year: 2020).*

* cited by examiner

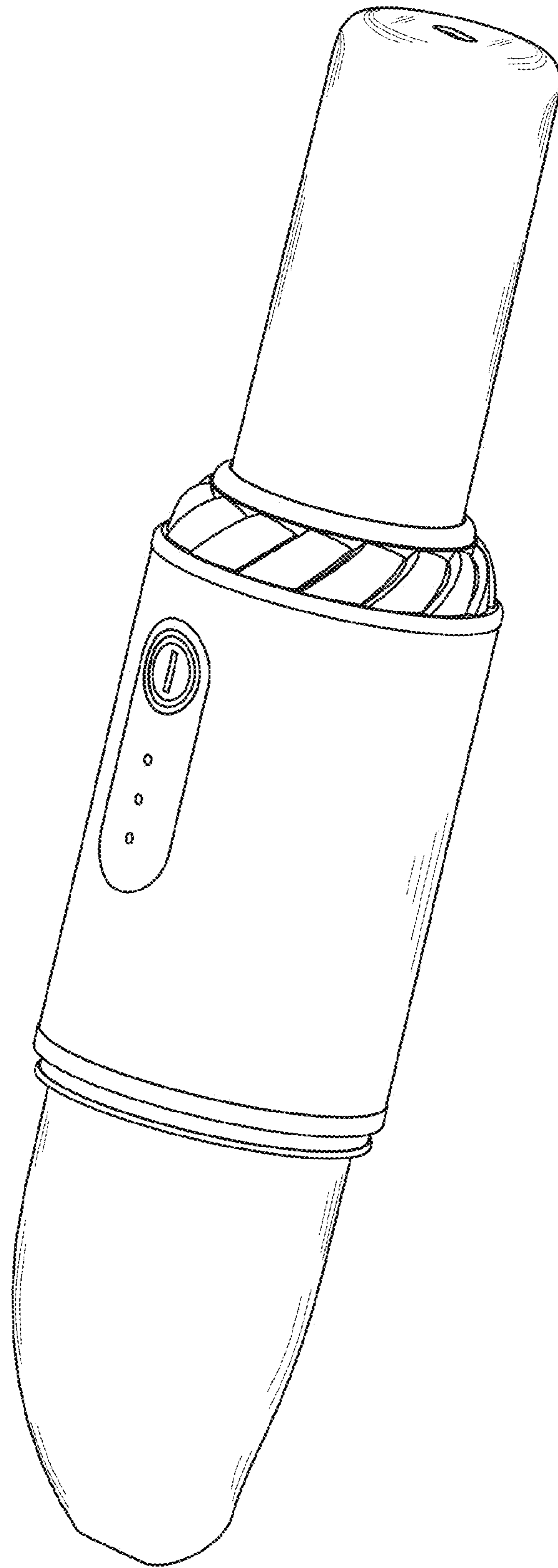

FIG. 1

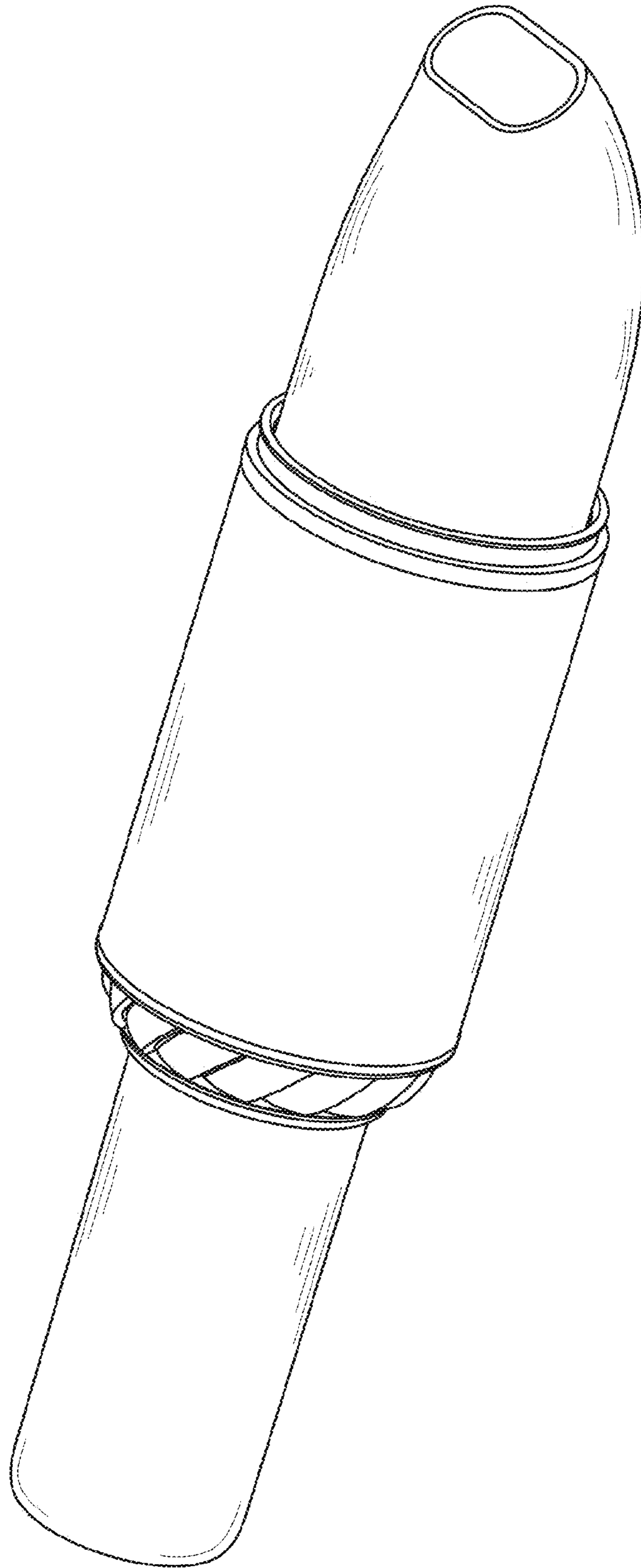

FIG.2

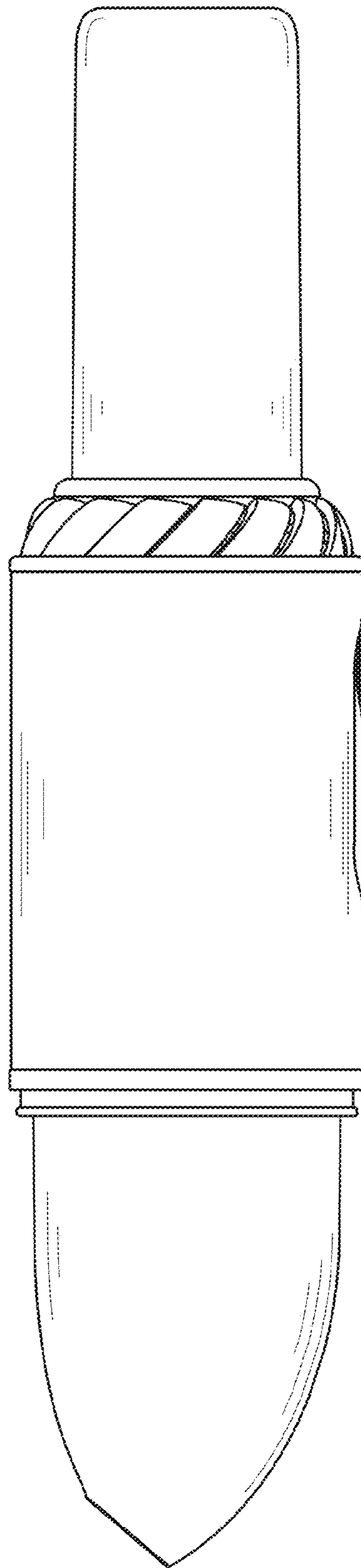

FIG.3

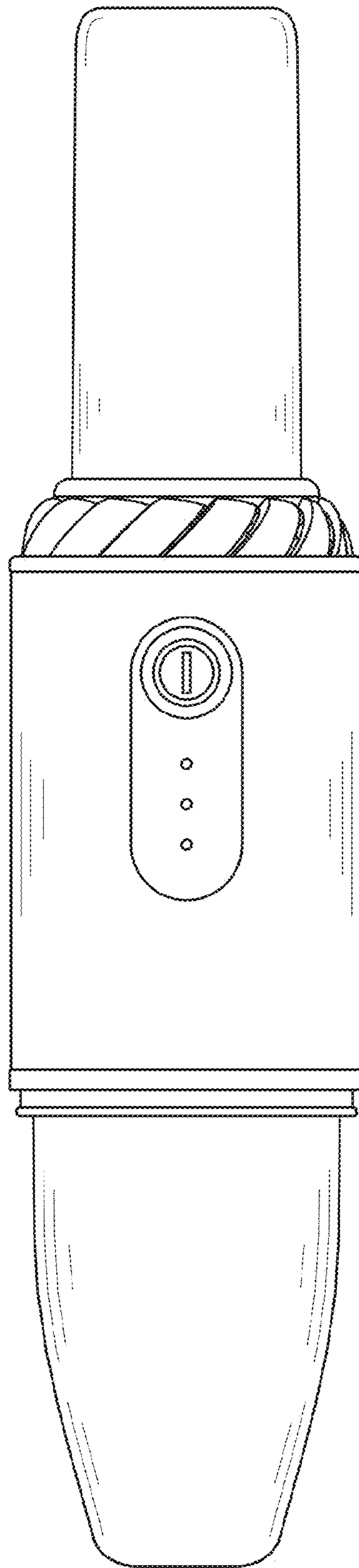

FIG.4

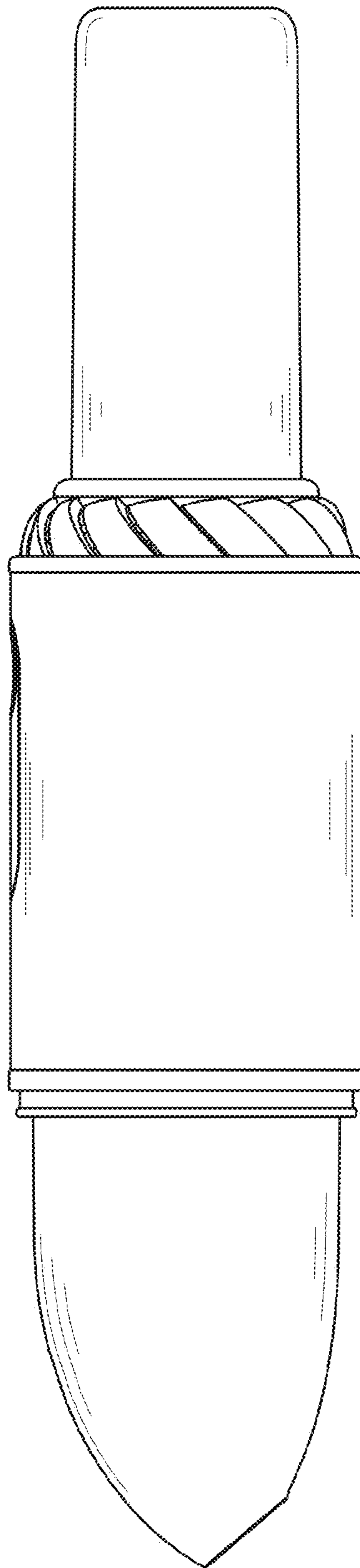

FIG. 5

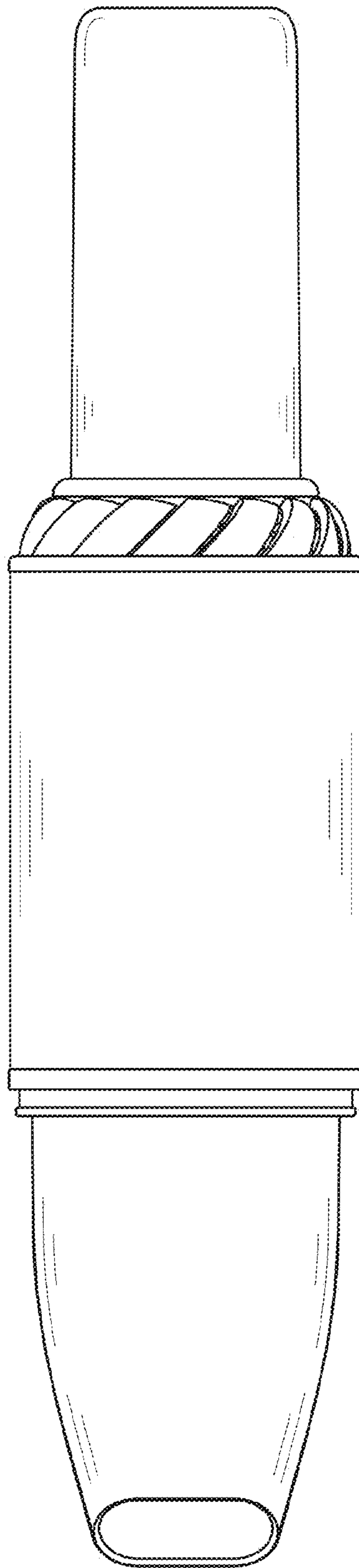

FIG.6

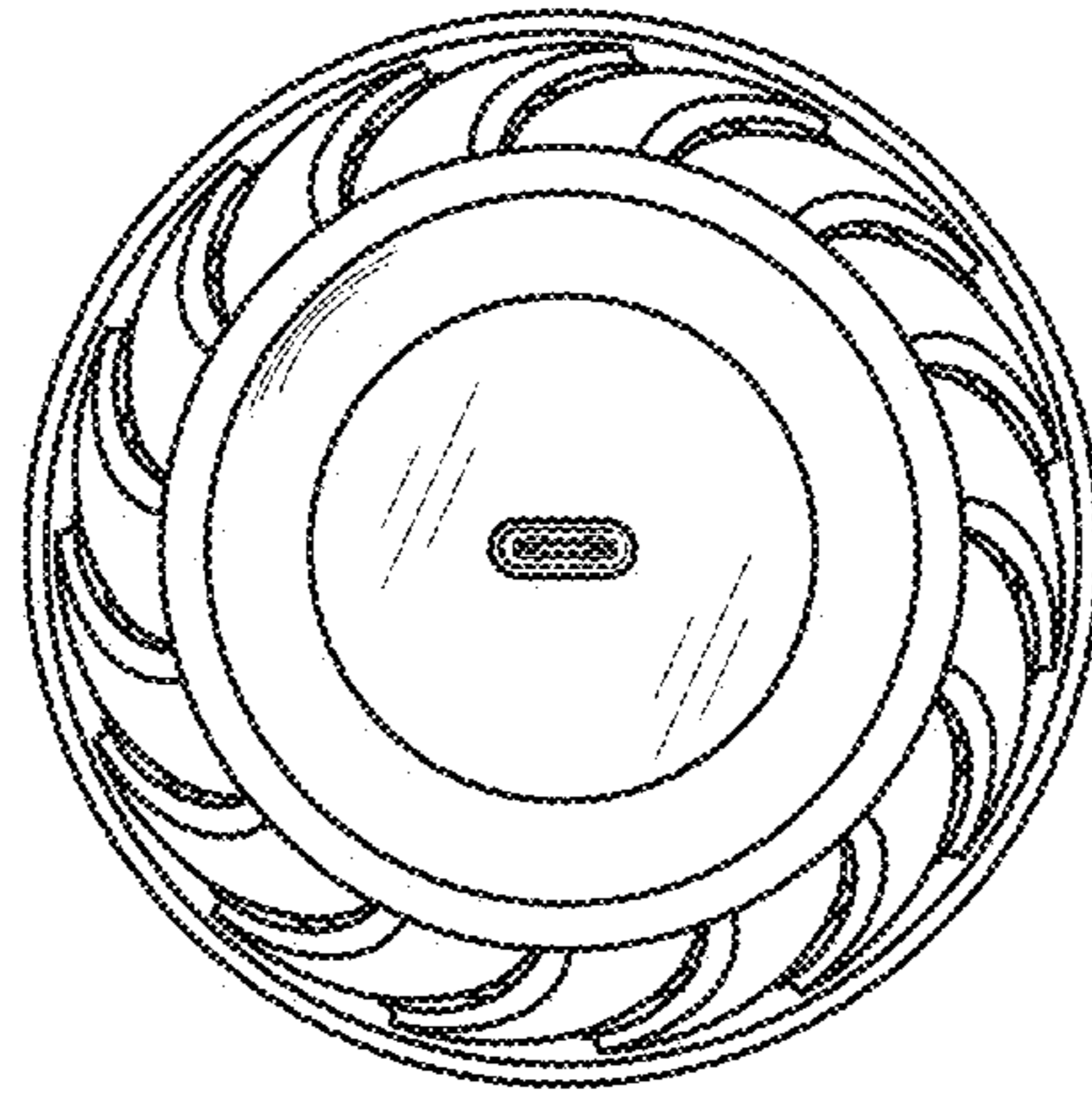

FIG.7

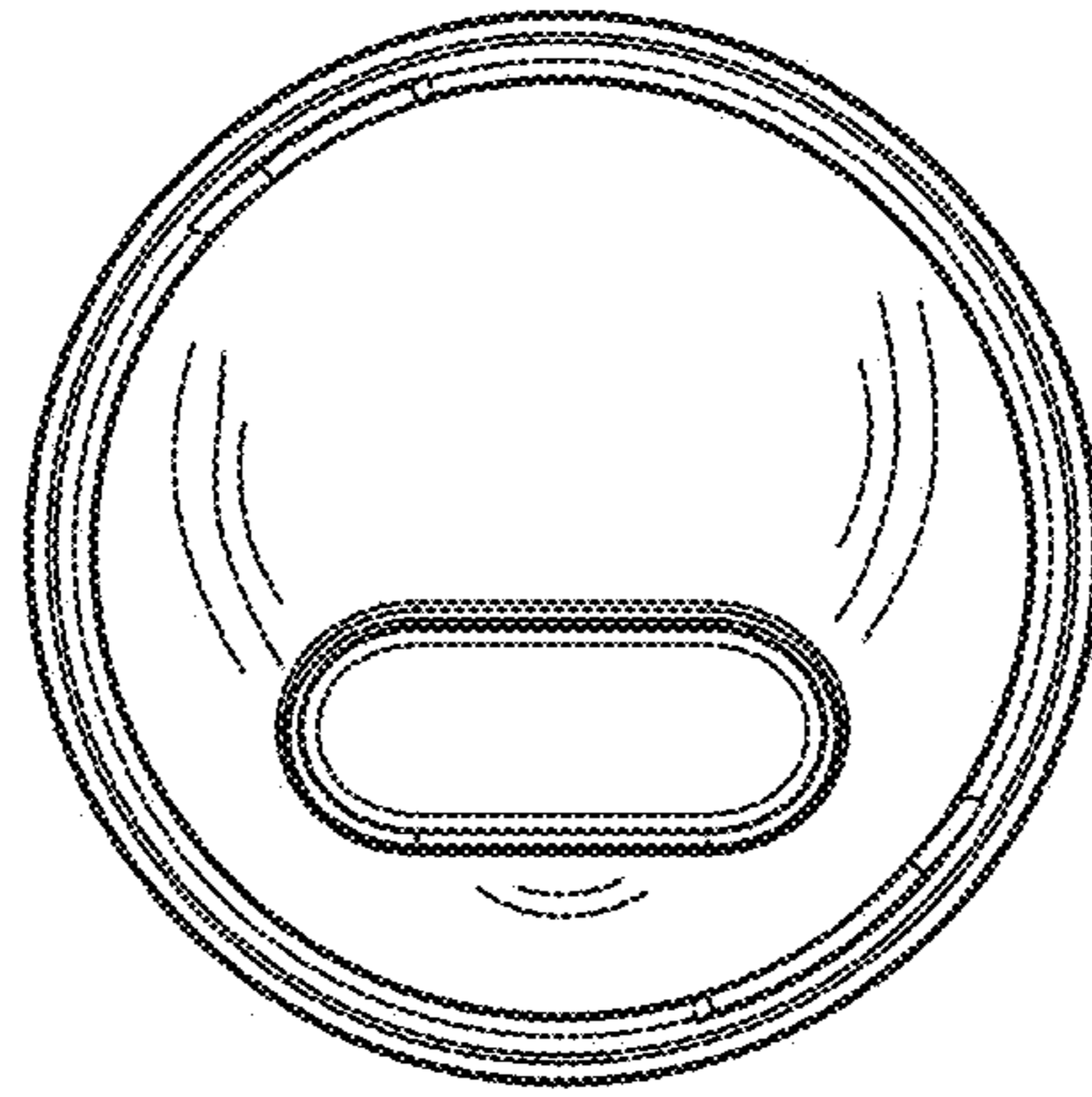

FIG.8