



US00D925812S

(12) **United States Design Patent** (10) **Patent No.:** **US D925,812 S**  
**Luo et al.** (45) **Date of Patent:** **\*\* Jul. 20, 2021**

(54) **DOME LIGHT**  
(71) Applicant: **Excelitas Canada Inc.**, Mississauga (CA)  
(72) Inventors: **Roy Luo**, Mississauga (CA); **Yong Wang**, Mississauga (CA); **Kevin Wang**, Mississauga (CA); **Yu Song**, Mississauga (CA)

(\*\*) Term: **15 Years**

(21) Appl. No.: **35/508,467**

(22) Filed: **Jul. 26, 2019**

(80) **Hague Agreement Data**

Int. Filing Date: **Jul. 26, 2019**  
Int. Reg. No.: **DM/204374**  
Int. Reg. Date: **Jul. 26, 2019**  
Int. Reg. Pub. Date: **Jan. 31, 2020**

(51) **LOC (13) Cl.** ..... **26-05**

(52) **U.S. Cl.**  
USPC ..... **D26/123**

(58) **Field of Classification Search**  
USPC ..... D26/72, 85, 88, 118, 36, 113, 120-124  
CPC ..... F21S 8/00; F21S 8/02; F21S 8/026; B60Q 3/43  
See application file for complete search history.

(56) **References Cited**

**U.S. PATENT DOCUMENTS**

251,711 A \* 1/1882 Goldsmith ..... F21V 7/24 362/341  
1,253,813 A \* 1/1918 Gray ..... F21V 7/04 362/348  
D136,162 S \* 8/1943 Lee' ..... D23/414  
D192,099 S \* 1/1962 Bordinat, Jr. .... D26/36  
D223,954 S \* 6/1972 Nagel ..... D26/123  
D370,550 S \* 6/1996 Lecluze ..... D26/118  
D389,269 S \* 1/1998 Porter ..... D26/118

D400,292 S \* 10/1998 Hoffbauer ..... D26/135  
D419,716 S \* 1/2000 Parrochia ..... D26/118  
D463,590 S \* 9/2002 Huang ..... D26/36  
D473,009 S \* 4/2003 Jarrett ..... D26/123  
D544,640 S \* 6/2007 Sase ..... D26/123  
D608,493 S \* 1/2010 Zaderej ..... D26/123  
D707,877 S \* 6/2014 Turner ..... D26/118  
D720,878 S \* 1/2015 Yu ..... D26/118  
D725,818 S \* 3/2015 Yao ..... D26/118  
D748,848 S \* 2/2016 Laukkanen ..... D26/118  
D806,308 S \* 12/2017 Pattekar ..... F21K 9/232  
D812,805 S \* 3/2018 Bendtsen ..... F21S 8/00  
D869,738 S \* 12/2019 Cheng ..... D26/113  
D894,472 S \* 8/2020 Boerup ..... D26/118  
2011/0280023 A1 \* 11/2011 Lee ..... F21V 5/04 362/338  
2013/0135854 A1 \* 5/2013 Huang ..... F21K 9/00 362/231  
2015/0204520 A1 \* 7/2015 Pearson ..... F21V 7/0008 362/294

(Continued)

**FOREIGN PATENT DOCUMENTS**

WO RGN-D204374-001 \* 1/2020

*Primary Examiner* — Kevin K Rudzinski  
*Assistant Examiner* — Richard Kearney

(57) **CLAIM**

The ornamental design for a dome light, as shown and described.

**DESCRIPTION**

- 1. Dome light
- 1.1: Perspective
- 1.2: Front
- 1.3: Back
- 1.4: Top
- 1.5: Bottom
- 1.6: Left
- 1.7: Right

**1 Claim, 7 Drawing Sheets**

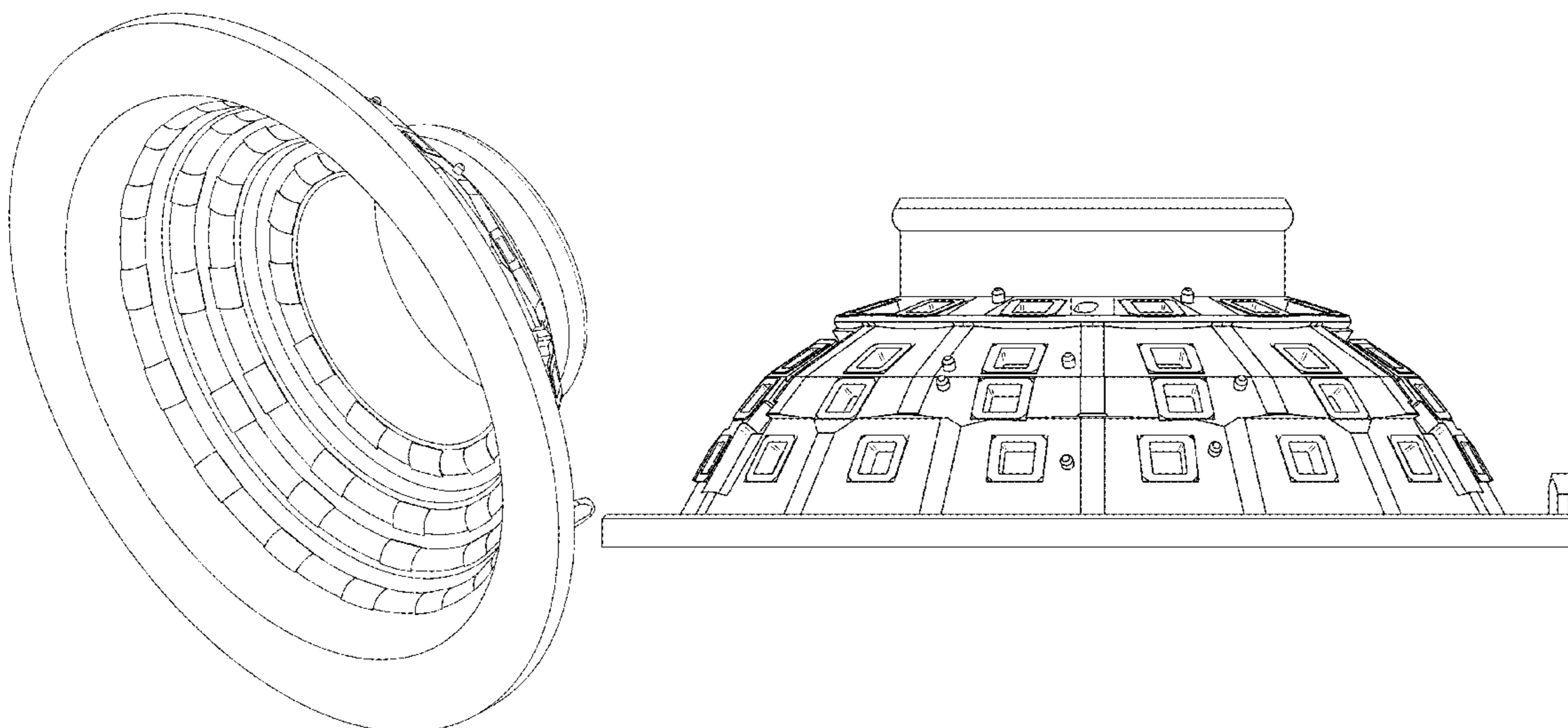

(56)

**References Cited**

U.S. PATENT DOCUMENTS

2015/0276199 A1\* 10/2015 Zanolà ..... F21S 8/024  
362/294  
2020/0386376 A1\* 12/2020 Zeng ..... F21S 8/026

\* cited by examiner

1.1

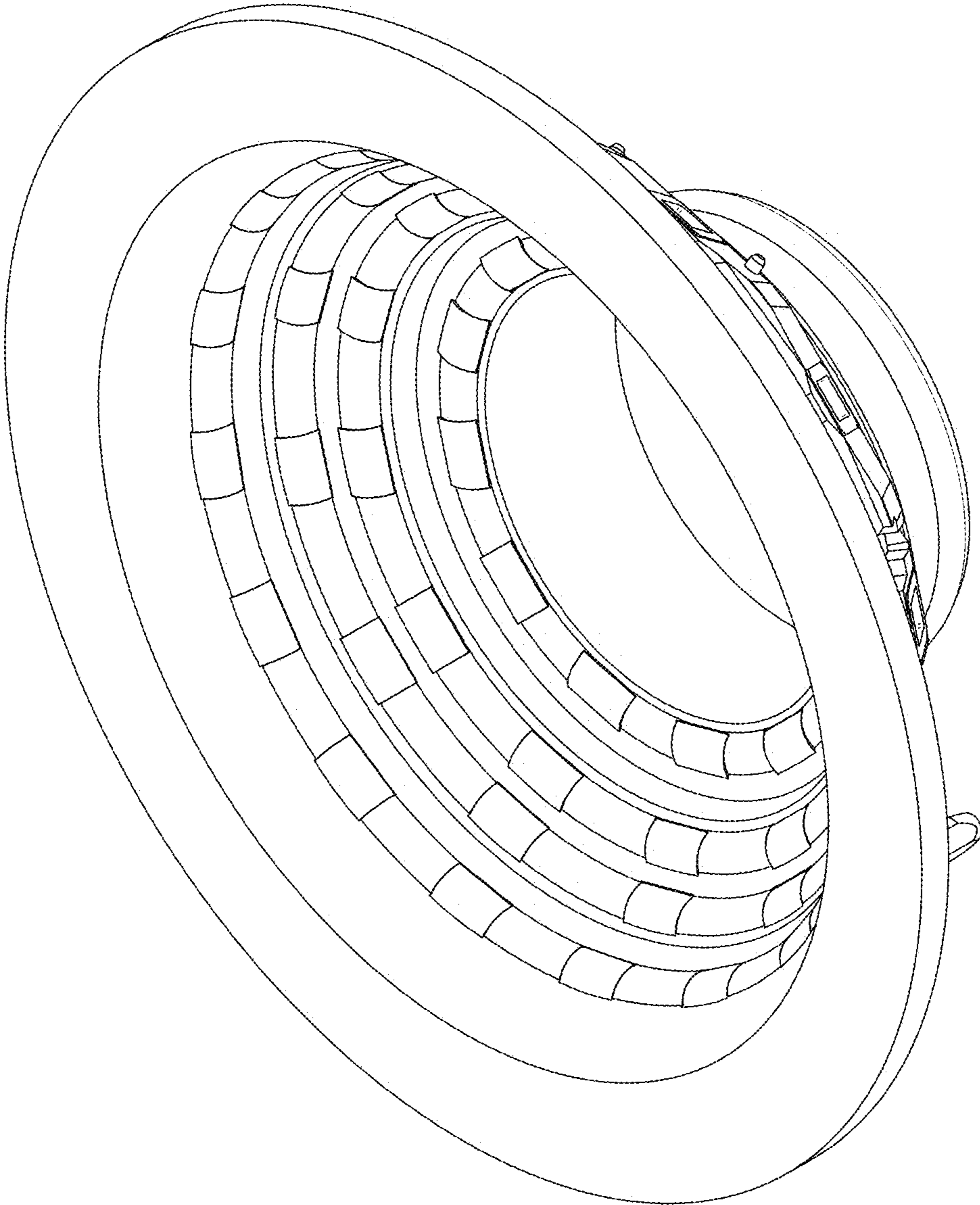

1.2

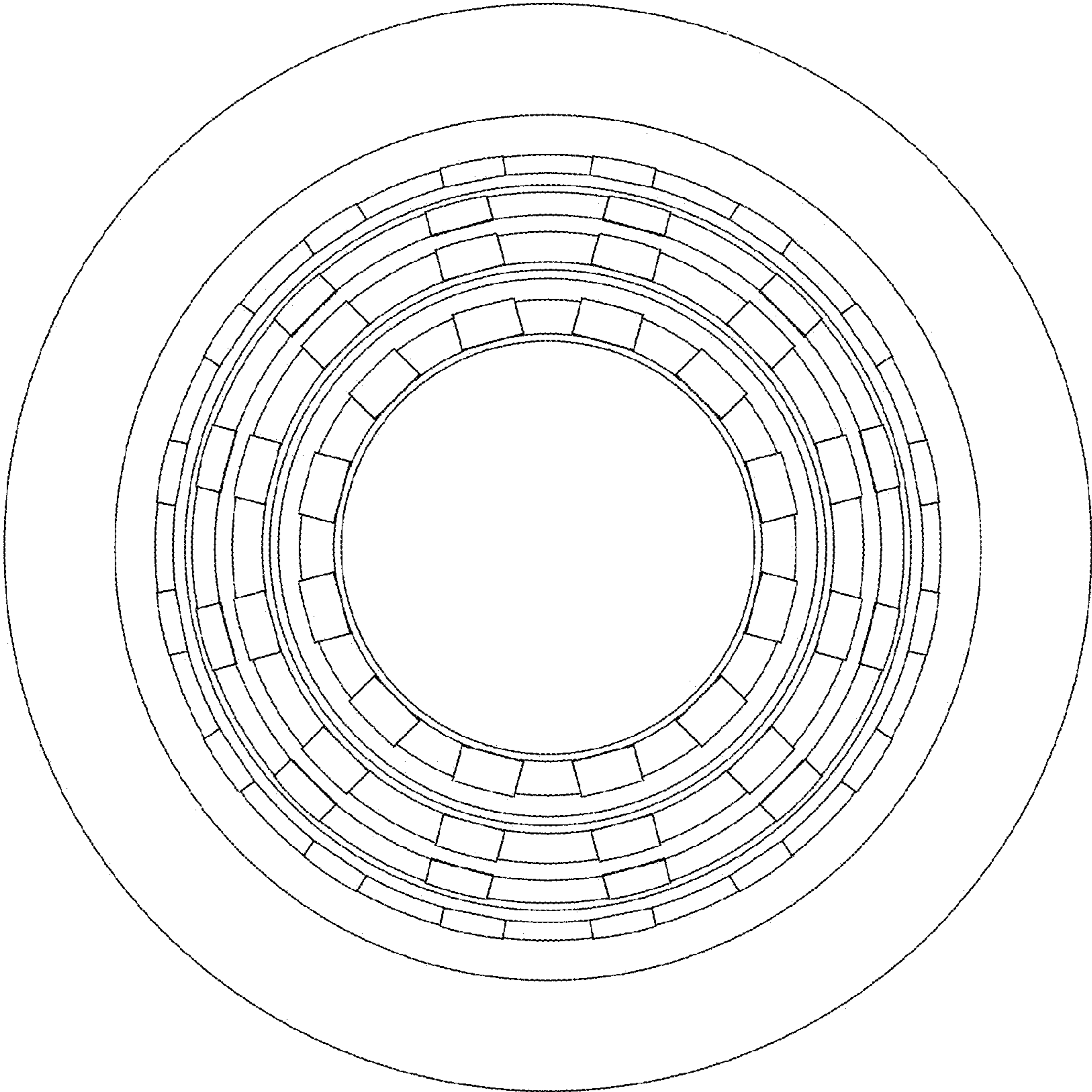

1.3

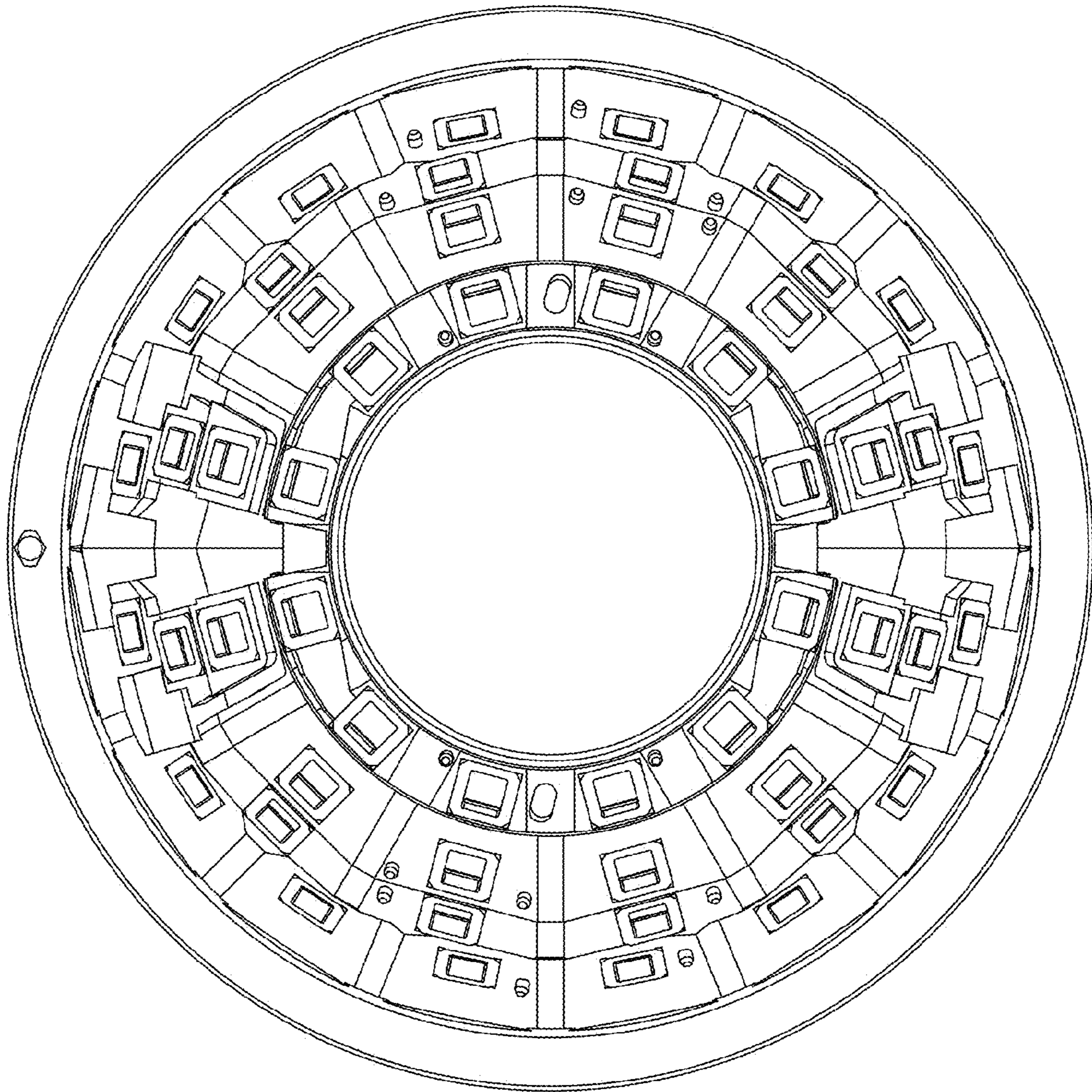

1.4

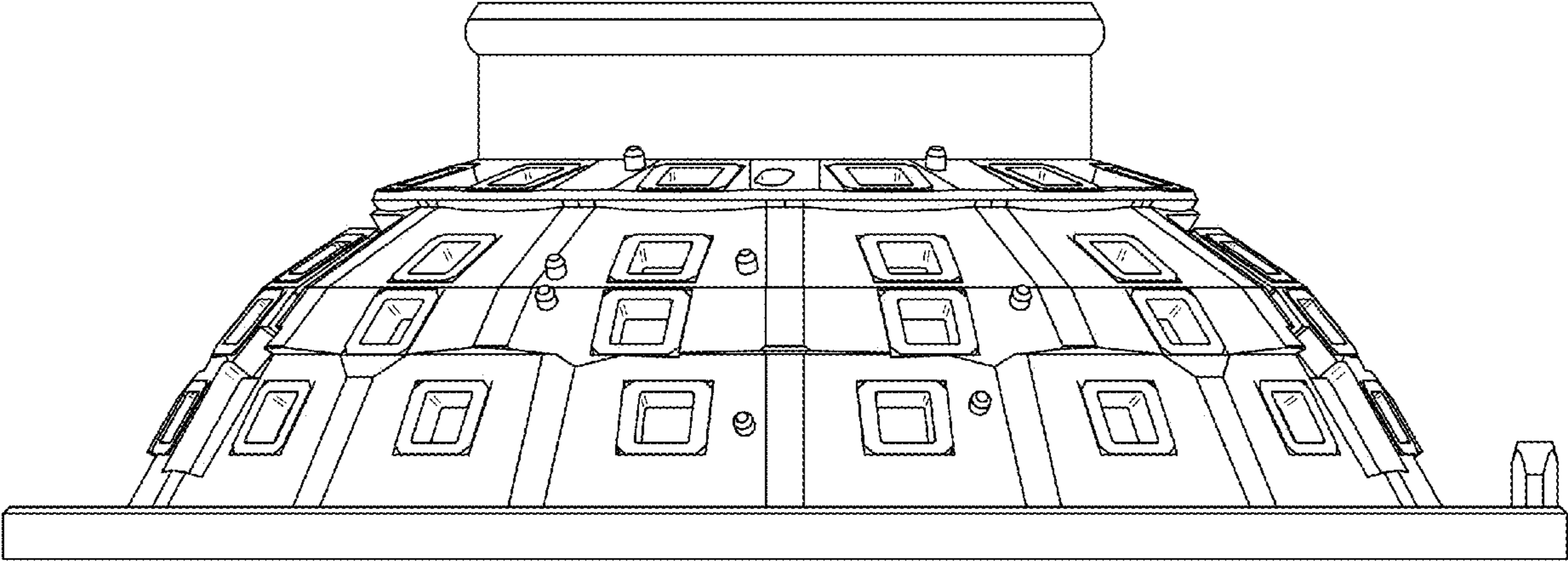

1.5

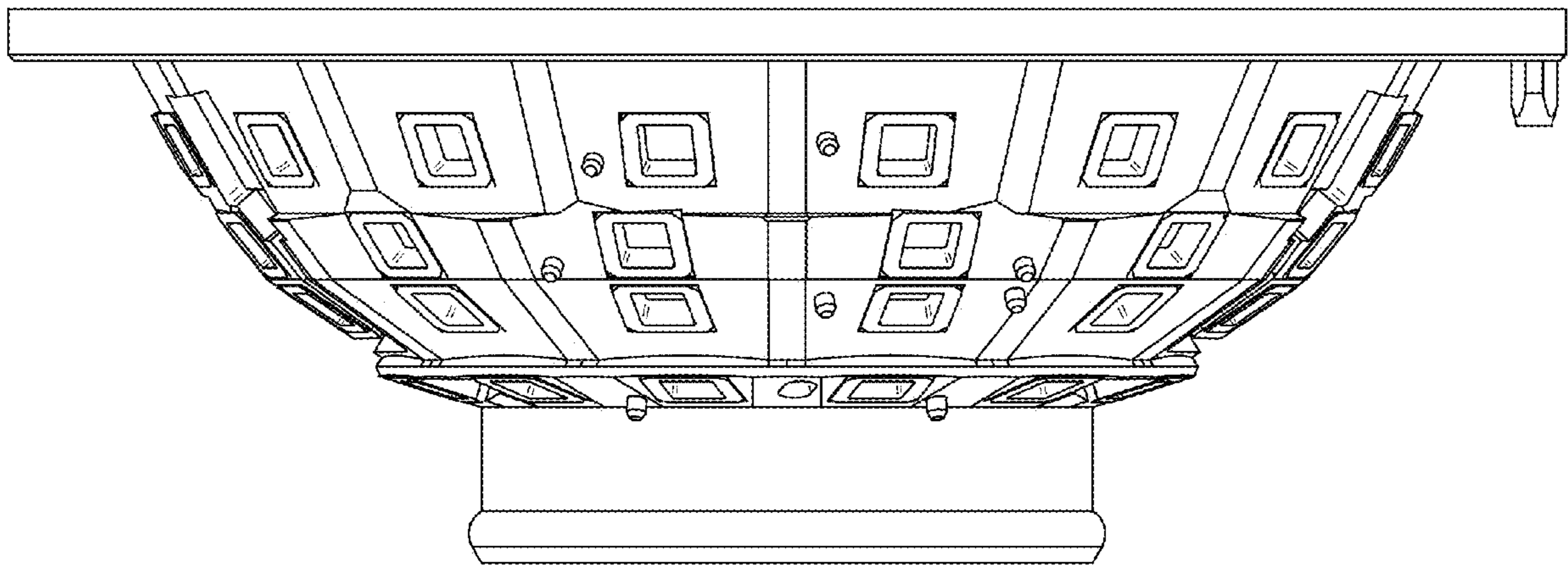

1.6

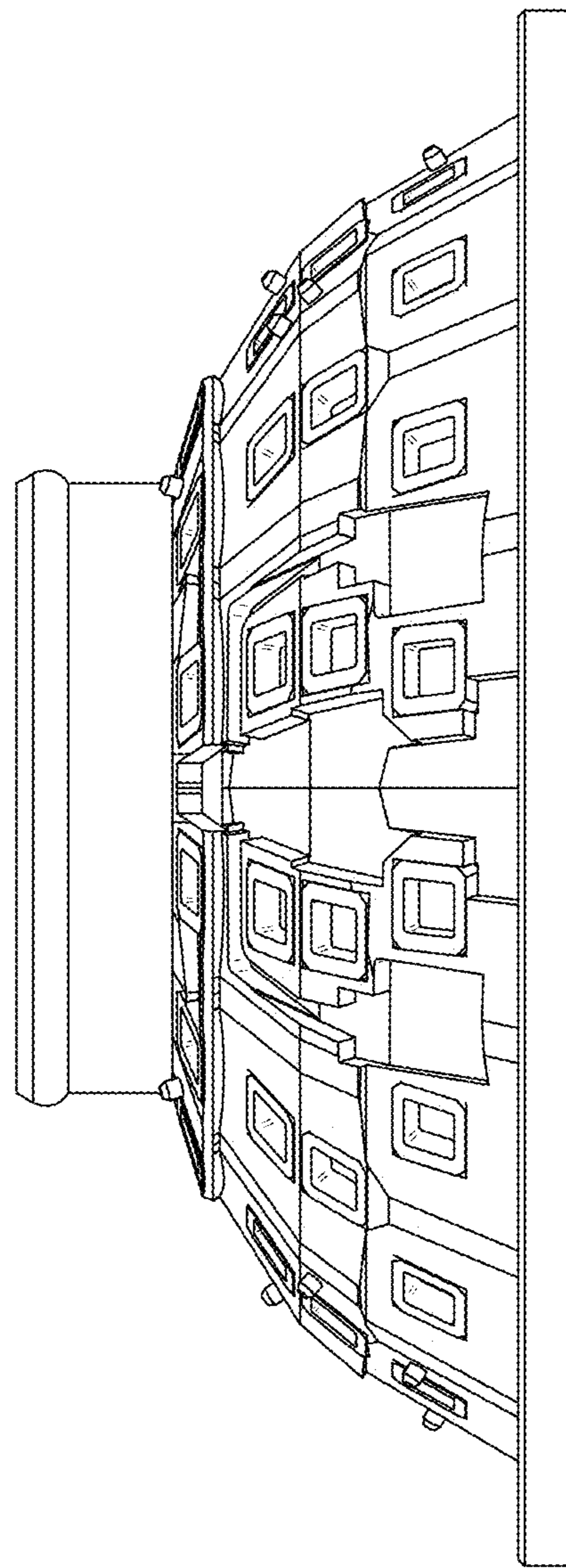



1.7

