



US00D925746S

(12) **United States Design Patent** (10) **Patent No.:** **US D925,746 S**  
**Tseng** (45) **Date of Patent:** **\*\* Jul. 20, 2021**

(54) **MULTI-LIFTING COLD AND HEAT BEAUTY DEVICE**

(71) Applicant: **Lifetrons Switzerland Holdings Limited**, Tuen Mun (HK)

(72) Inventor: **Chih-Ming Tseng**, Tuen Mun (HK)

(73) Assignee: **LIFETRONS SWITZERLAND HOLDINGS LIMITED**, Tuen Mun (HK)

(\*\*) Term: **15 Years**

(21) Appl. No.: **29/703,979**

(22) Filed: **Aug. 30, 2019**

(51) **LOC (13) Cl.** ..... **28-03**

(52) **U.S. Cl.**  
USPC ..... **D24/206; D24/211**

(58) **Field of Classification Search**  
USPC ..... D24/206–207, 209, 211–215, 200  
CPC ..... A61H 15/00; A61H 15/0078; A61H 15/0085; A61H 15/0092; A61H 2015/0007; A61H 2015/00174; A61H 2015/0042; A61F 7/0085; A61F 7/02; A61F 2007/0001; A61F 2007/0002; A61F 2007/0003; A61F 2007/0014; A61F 2007/0024; A61F 2007/0029; A61F 2007/0036; A61F 2007/0039; A61F 2007/0042; A61F 2007/0056; A61F 2007/0063; A61F 2007/0087; A61F 2007/0011

See application file for complete search history.

(56) **References Cited**

**U.S. PATENT DOCUMENTS**

D333,351 S \* 2/1993 Tsou ..... D24/206  
D668,771 S \* 10/2012 Matsushita ..... D24/211

D822,841 S \* 7/2018 Cheng ..... D24/206  
D865,206 S \* 10/2019 Matsushita ..... D24/211  
D865,208 S \* 10/2019 Matsushita ..... D24/211  
D874,666 S \* 2/2020 Matsushita ..... D24/211  
D887,572 S \* 6/2020 Matsushita ..... D24/211  
2014/0288473 A1\* 9/2014 Matsushita ..... A61H 15/00  
601/137  
2018/0116903 A1\* 5/2018 Matsushita ..... A61H 15/00  
2020/0383867 A1\* 12/2020 Matsushita ..... A61H 15/0085

**OTHER PUBLICATIONS**

6-in-1 Multi-Lifting Cold & Heat Beauty Device. Retrieved on Nov. 16, 2020. Retrieved from the Internet: <URL: <https://sourcing.hktdc.com/en/Product-Detail/6-in-1-Multi-Lifting-Cold-Heat-Beauty-Device/3636410>>.\*

\* cited by examiner

*Primary Examiner* — Wan Laymon

(74) *Attorney, Agent, or Firm* — Muncy, Geissler, Olds & Lowe, P.C.

(57) **CLAIM**

The ornamental design for a multi-lifting cold and heat beauty device, as shown and described.

**DESCRIPTION**

FIG. 1 is a perspective view of a multi-lifting cold and heat beauty device showing my new design; FIG. 2 is a front plan view thereof; FIG. 3 is a rear plan view thereof; FIG. 4 is a first side view thereof; FIG. 5 is a second side view thereof; FIG. 6 is an enlarged top view thereof; and, FIG. 7 is an enlarged bottom view thereof. The broken lines showing in the drawings are included for the purpose of illustrating portions of the multi-lifting cold & heat beauty device and form no part of the claimed design.

**1 Claim, 7 Drawing Sheets**

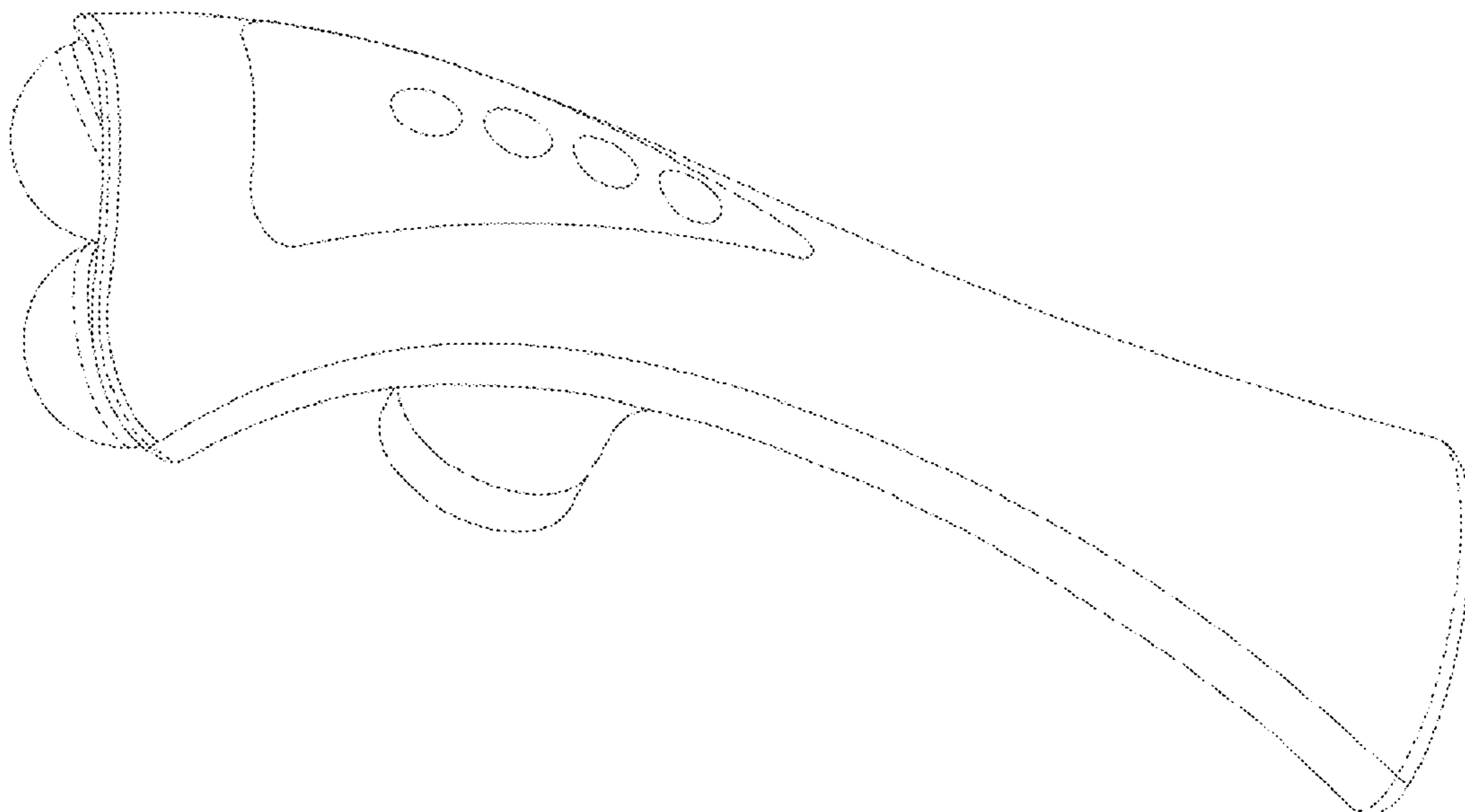

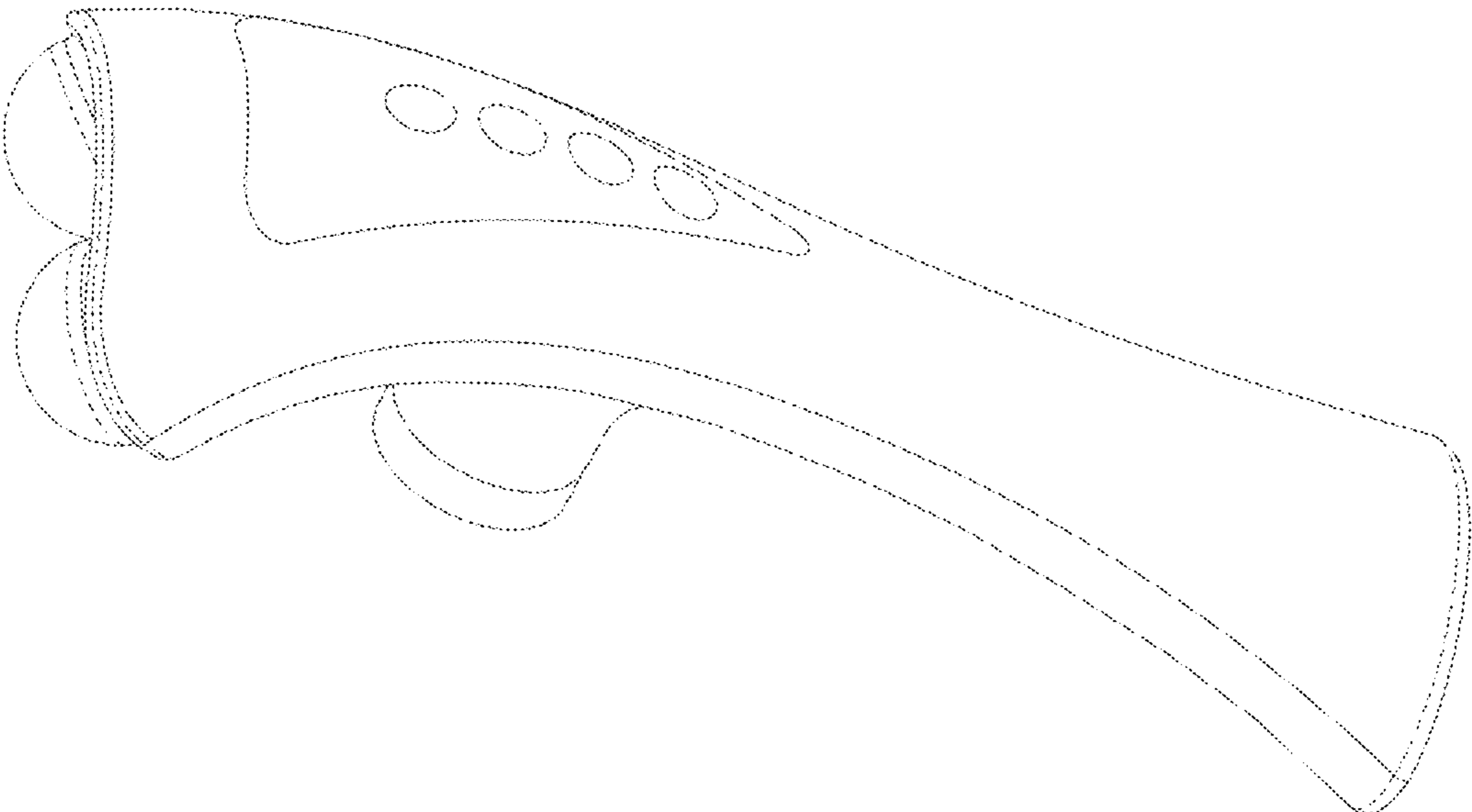

Fig. 1

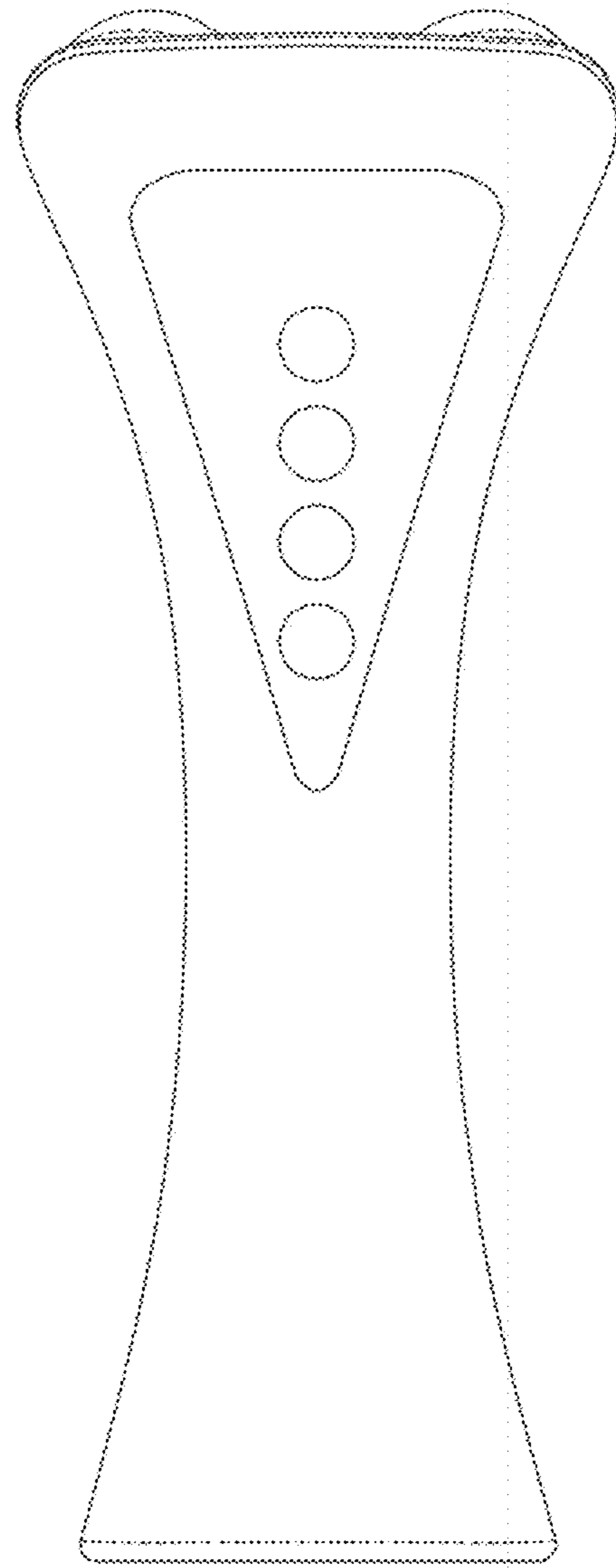

Fig. 2

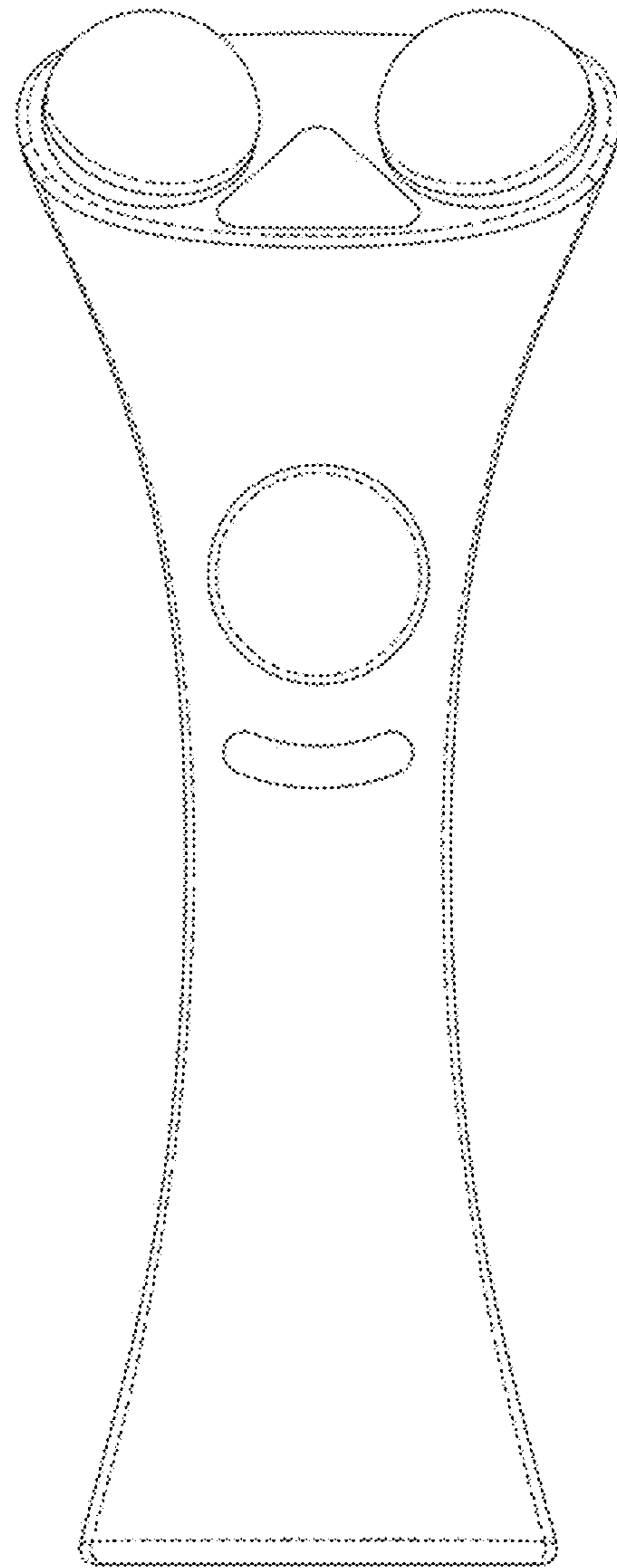

Fig. 3

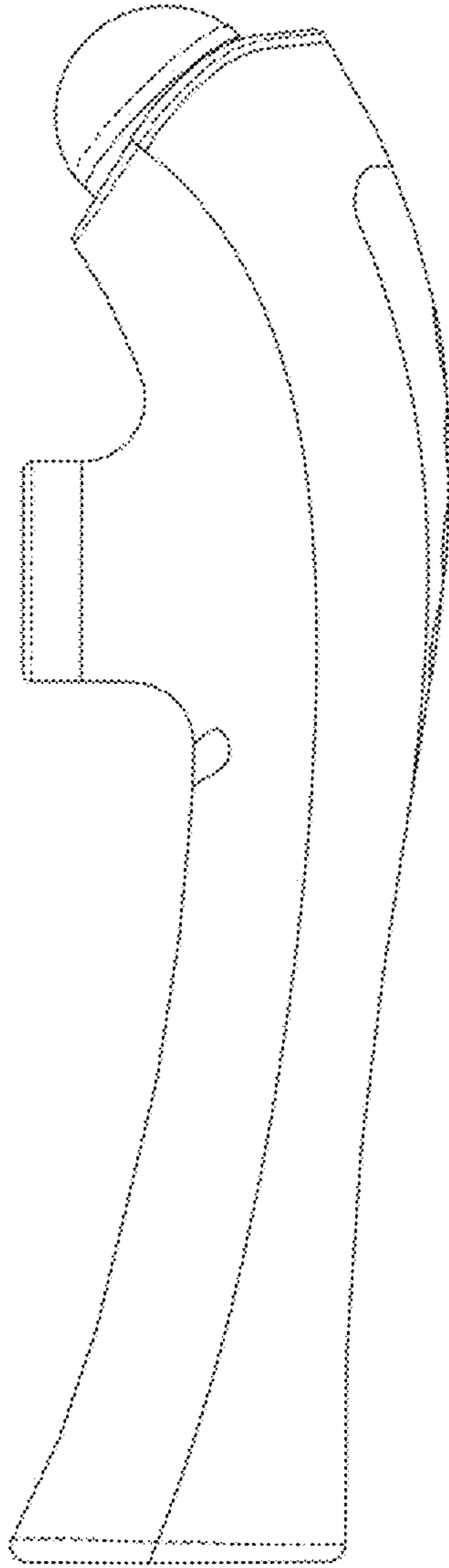

Fig. 4

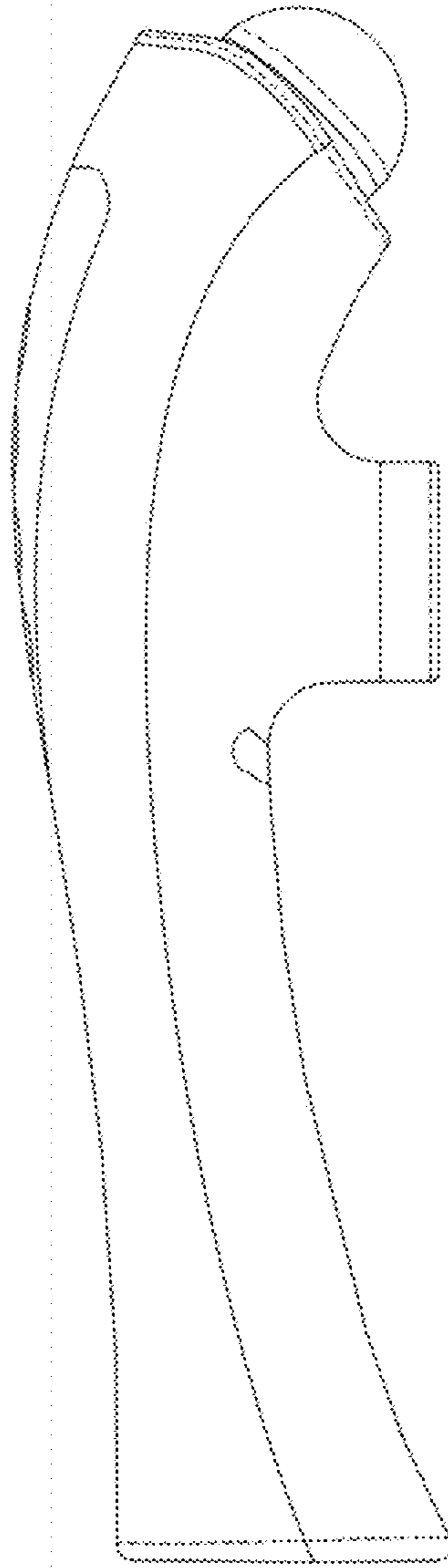

Fig. 5

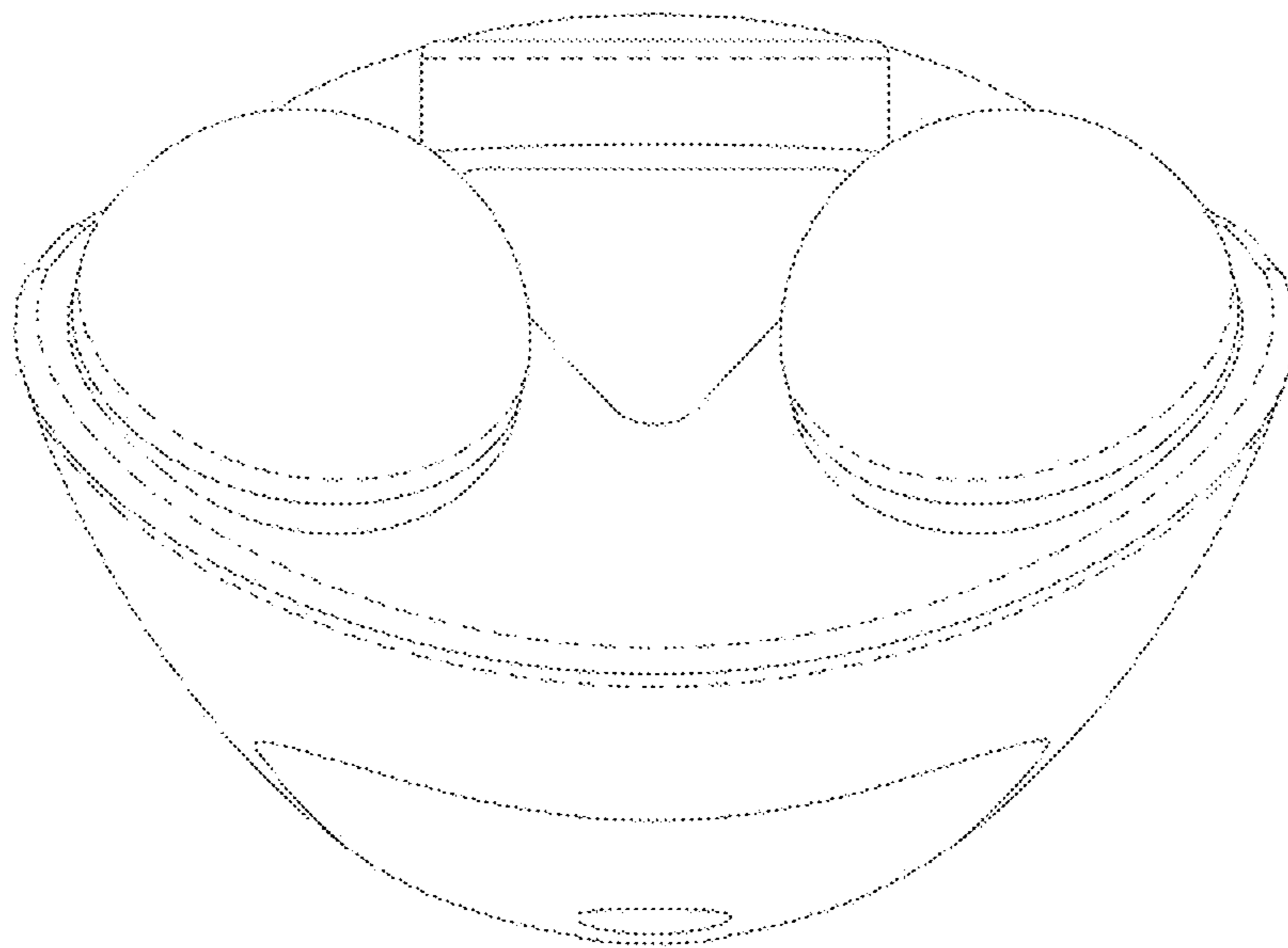

Fig. 6

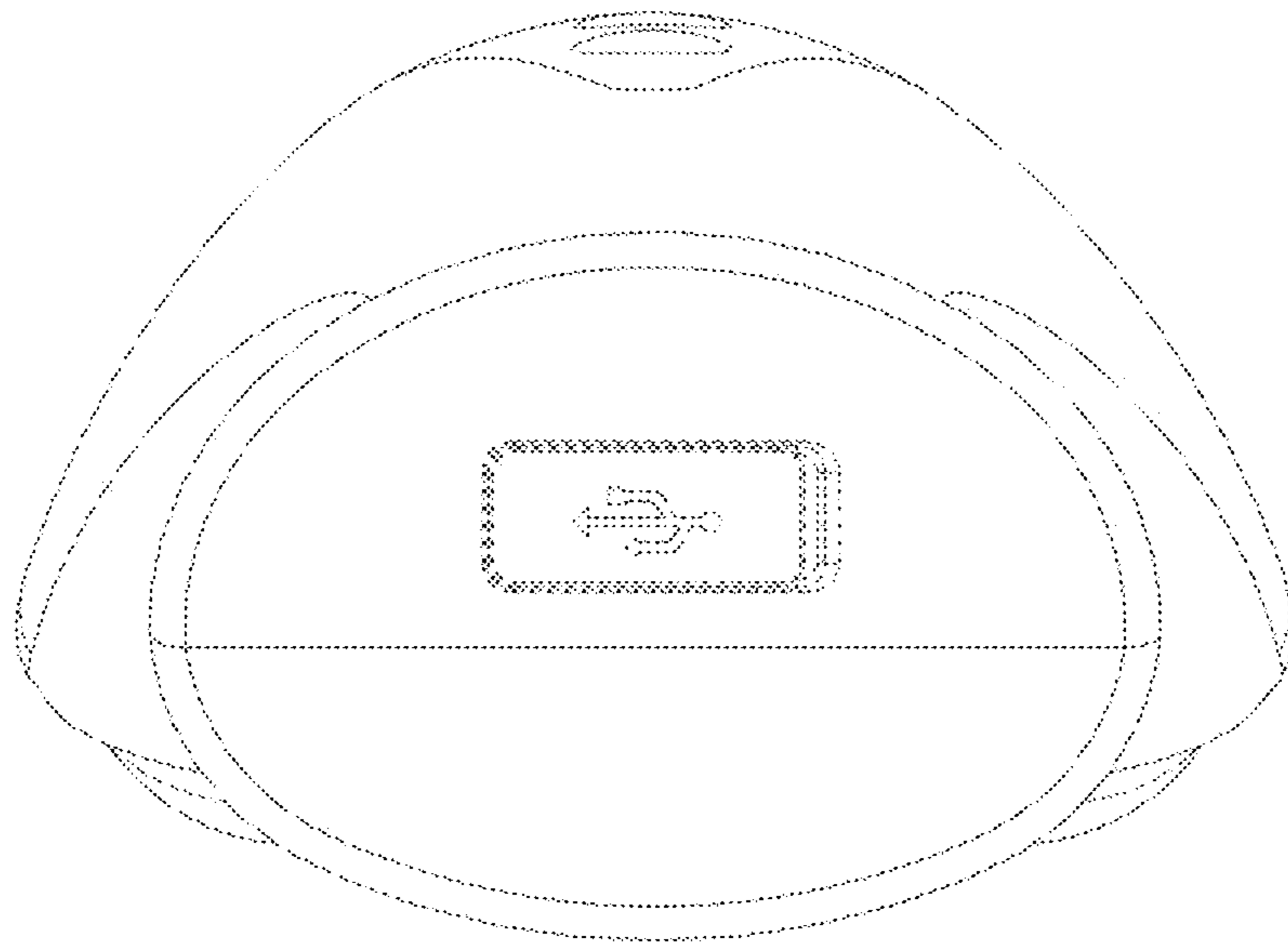

Fig. 7