



US00D925653S

(12) **United States Design Patent** (10) **Patent No.:** **US D925,653 S**  
**Epstein** (45) **Date of Patent:** **\*\* Jul. 20, 2021**

- (54) **PEN**
- (71) Applicant: **GMG Pen LLC**, Lakewood, NJ (US)
- (72) Inventor: **David A. Epstein**, Lakewood, NJ (US)
- (73) Assignee: **GMG Pen LLC**, Lakewood, NJ (US)
- (\*\*) Term: **15 Years**
- (21) Appl. No.: **29/716,859**
- (22) Filed: **Dec. 12, 2019**
- (51) **LOC (13) Cl.** ..... **19-06**
- (52) **U.S. Cl.**  
USPC ..... **D19/174; D19/926**
- (58) **Field of Classification Search**  
USPC ..... D19/115–204; D14/411  
CPC . B43K 5/005; B43K 7/12; B43K 8/04; B43K  
8/06; B43K 21/006; B43K 21/06  
See application file for complete search history.

- D628,640 S \* 12/2010 Wang ..... D19/173
- D628,645 S \* 12/2010 Zhang ..... D19/174
- D654,952 S \* 2/2012 Laemle ..... D19/172
- D709,949 S \* 7/2014 Fleming ..... D19/119
- D713,882 S \* 9/2014 Fleming ..... D19/179
- D730,988 S \* 6/2015 Cleere ..... D19/201
- D745,089 S \* 12/2015 Cohen ..... D19/174
- D751,144 S \* 3/2016 Goodelman ..... D19/171
- D755,293 S \* 5/2016 Cleere ..... D19/201
- D757,850 S \* 5/2016 Zhang ..... D19/123
- D782,576 S \* 3/2017 Laemle ..... D19/172
- D863,433 S \* 10/2019 Jia ..... D19/171
- D890,843 S \* 7/2020 Fang ..... D19/174

\* cited by examiner

*Primary Examiner* — Elizabeth A. Albert  
 (74) *Attorney, Agent, or Firm* — Bochner IP, PLLC;  
 Andrew D. Bochner

(57) **CLAIM**

The ornamental design for a pen, as shown and described.

**DESCRIPTION**

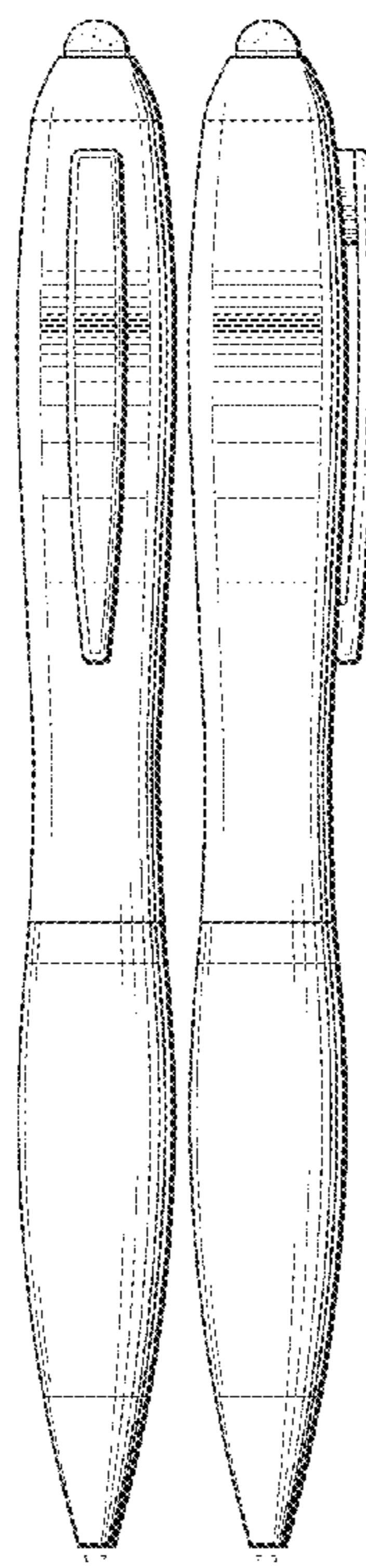
FIG. 1 is a top, front, right side perspective view of the pen;  
 FIG. 2 is a top plan view thereof, shown at an enlarged scale;  
 FIG. 3 is a bottom plan view thereof, shown at an enlarged scale;  
 FIG. 4 is a front elevation view thereof,  
 FIG. 5 is a rear elevation view thereof, and,  
 FIG. 6 is a left side elevation view thereof, the right side  
 elevation view being a mirror image.  
 In the drawings, the broken lines are for the purpose of  
 illustrating environment only, and form no part of the  
 claimed design.

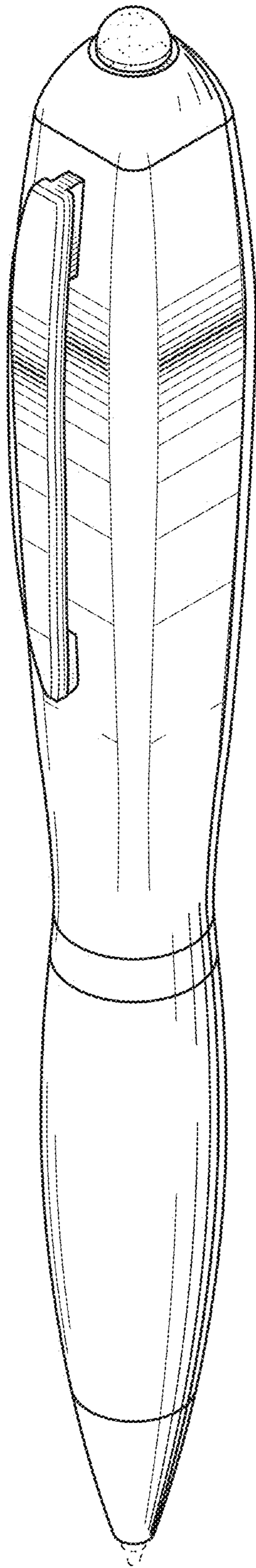
**1 Claim, 2 Drawing Sheets**

(56) **References Cited**

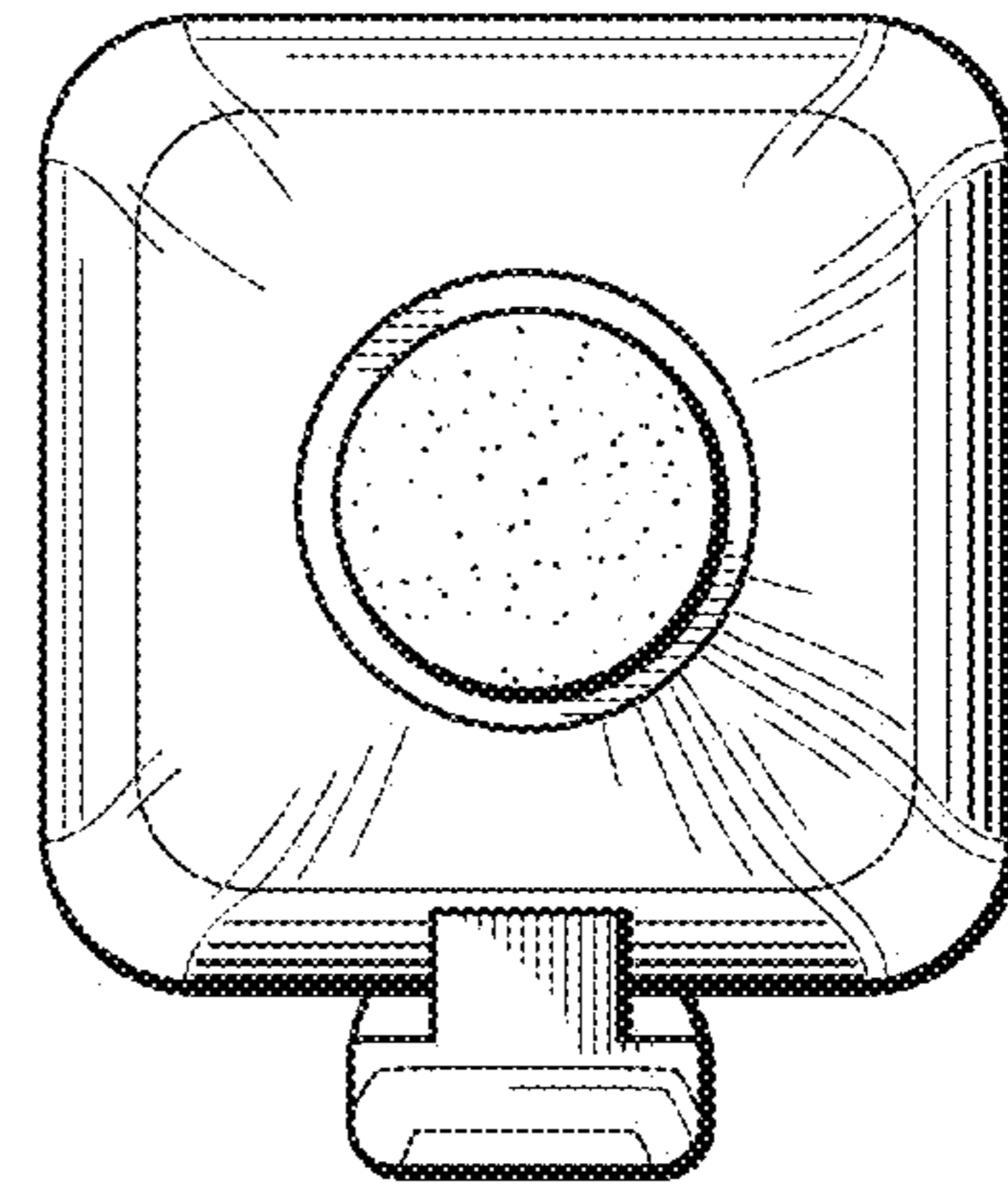
U.S. PATENT DOCUMENTS

- 4,983,062 A \* 1/1991 Hour ..... A63F 9/001  
273/153 S
- 6,024,104 A \* 2/2000 Dolberry ..... B43K 29/00  
132/309
- D433,704 S \* 11/2000 Kouda ..... D19/174
- D506,503 S \* 6/2005 Qiu ..... D19/174
- D512,741 S \* 12/2005 Cetera ..... D19/174
- D540,866 S \* 4/2007 Qiu ..... D19/174
- D550,282 S \* 9/2007 Neuenschwander ..... D19/174
- D552,174 S \* 10/2007 Tien ..... D19/174
- D553,679 S \* 10/2007 Tien ..... D19/174

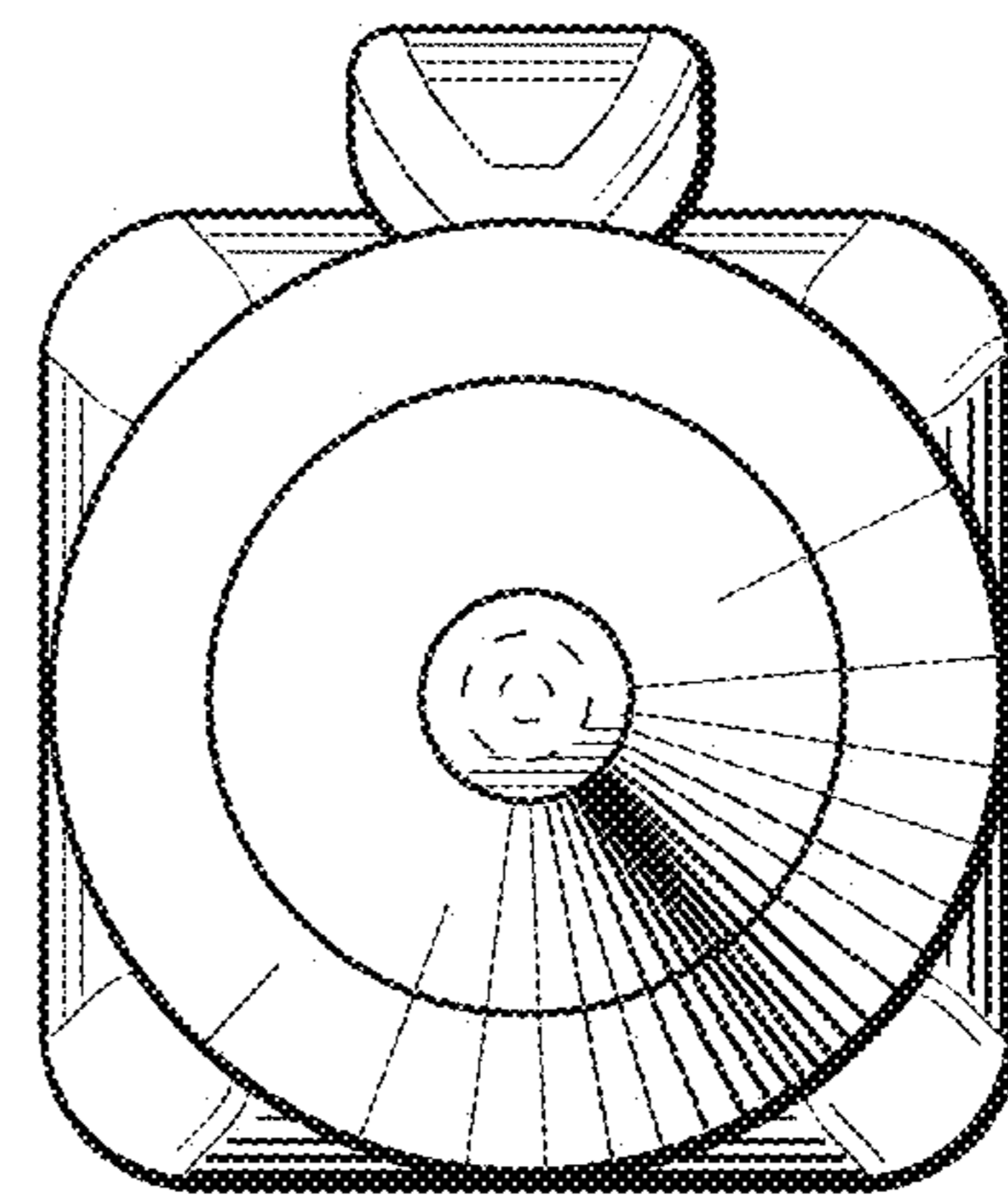




*FIG. 1*



*FIG. 2*



*FIG. 3*

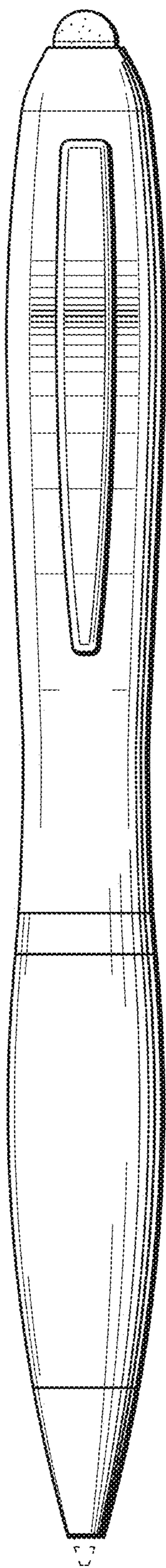


FIG. 4

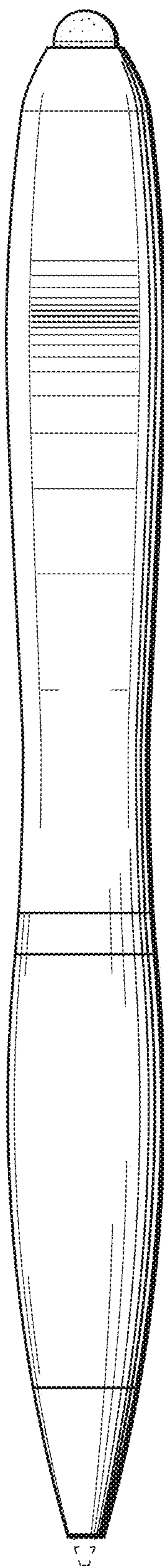


FIG. 5

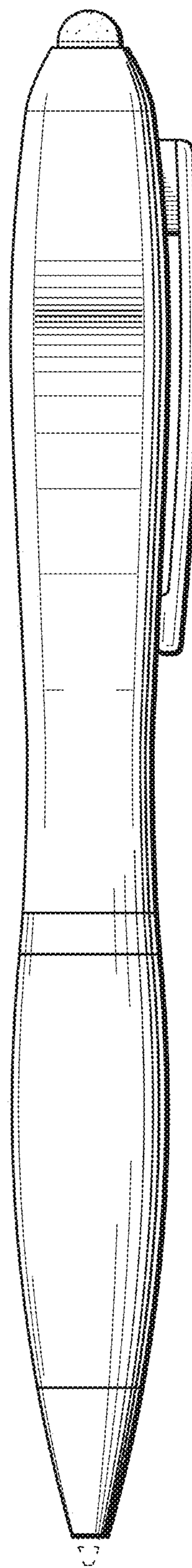


FIG. 6