



US00D925652S

(12) **United States Design Patent**
Epstein

(10) **Patent No.:** **US D925,652 S**

(45) **Date of Patent:** **** Jul. 20, 2021**

- (54) **PEN**
- (71) Applicant: **GMG Pen LLC**, Lakewood, NJ (US)
- (72) Inventor: **David A. Epstein**, Lakewood, NJ (US)
- (73) Assignee: **GMG Pen LLC**, Lakewood, NJ (US)
- (**) Term: **15 Years**
- (21) Appl. No.: **29/719,756**
- (22) Filed: **Jan. 7, 2020**
- (51) **LOC (13) Cl.** **19-06**
- (52) **U.S. Cl.**
USPC **D19/171; D19/926**
- (58) **Field of Classification Search**
USPC D19/115–204; D14/411
CPC . B43K 5/005; B43K 7/12; B43K 8/04; B43K
8/06; B43K 21/006; B43K 21/06
See application file for complete search history.

8,550,735 B2 *	10/2013	Rolion	B43K 24/084
				401/103
D708,671 S *	7/2014	Laemle	D19/174
D709,949 S *	7/2014	Fleming	D19/119
D713,882 S *	9/2014	Fleming	D19/179
D730,988 S *	6/2015	Cleere	D19/201
D745,089 S *	12/2015	Cohen	D19/174
D751,144 S *	3/2016	Goodelman	D19/171
D752,050 S *	3/2016	Zhang	D14/411
D753,768 S *	4/2016	Goodelman	D19/171
D755,293 S *	5/2016	Cleere	D19/201
D757,850 S *	5/2016	Zhang	D19/123
D771,749 S *	11/2016	Boisdevesys	D19/171
D780,268 S *	2/2017	Laemle	D19/170
D782,576 S *	3/2017	Laemle	D19/172
D813,948 S *	3/2018	Vadenne	D19/197
D863,433 S *	10/2019	Jia	D19/171
D890,843 S *	7/2020	Fang	D19/174

* cited by examiner

Primary Examiner — Elizabeth A. Albert
(74) *Attorney, Agent, or Firm* — Bochner IP, PLLC;
Andrew D. Bochner

(57) **CLAIM**

The ornamental design for a pen, as shown and described.

DESCRIPTION

FIG. 1 is a front, left side perspective view of the pen;
FIG. 2 is a top plan view thereof, shown at an enlarged scale;
FIG. 3 is a bottom plan view thereof, shown at an enlarged scale;
FIG. 4 is a front elevation view thereof;
FIG. 5 is a rear elevation view thereof; and,
FIG. 6 is a left side elevation view thereof, the right side elevation view being a mirror image.
In the drawings, the broken lines are for the purpose of illustrating environment only, and form no part of the claimed design.

1 Claim, 2 Drawing Sheets

(56) **References Cited**

U.S. PATENT DOCUMENTS

D308,075 S *	5/1990	Yazaki	D19/165
4,983,062 A *	1/1991	Hour	A63F 9/001
				273/153 S
D395,448 S *	6/1998	Chevalier	D19/174
D540,866 S *	4/2007	Qiu	D19/174
D550,282 S *	9/2007	Neuenschwander	D19/174
D573,184 S *	7/2008	Vadenne	D19/174
D601,197 S *	9/2009	Zhang	D19/174
D612,888 S *	3/2010	Rolion	D19/171
D628,640 S *	12/2010	Wang	D19/173
D628,645 S *	12/2010	Zhang	D19/174
D654,952 S *	2/2012	Laemle	D19/172
D665,025 S *	8/2012	Li	D19/172
D672,393 S *	12/2012	Mao	D19/172
D689,134 S *	9/2013	Landow	D19/174

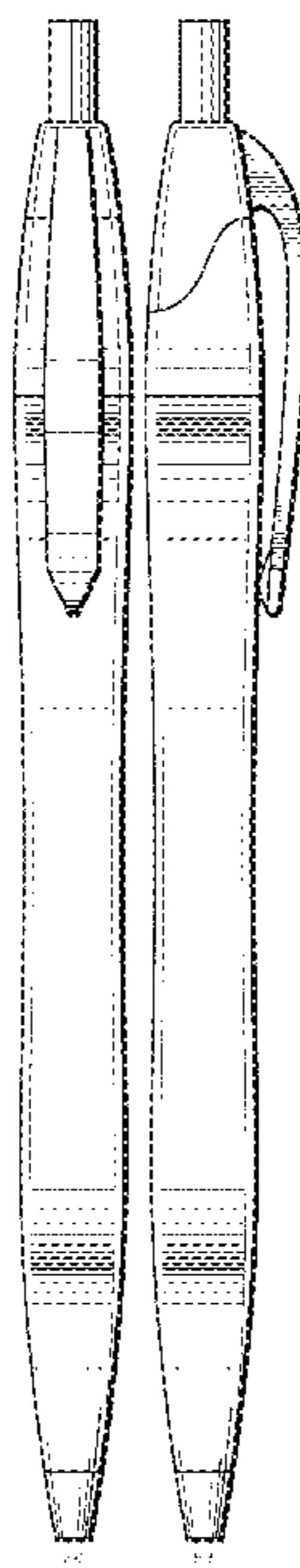

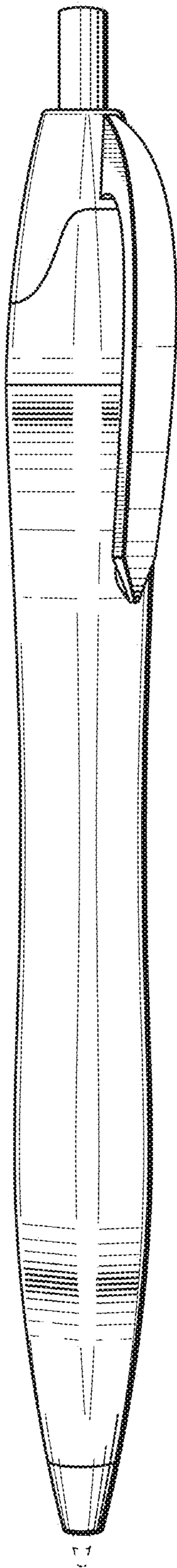

FIG. 1

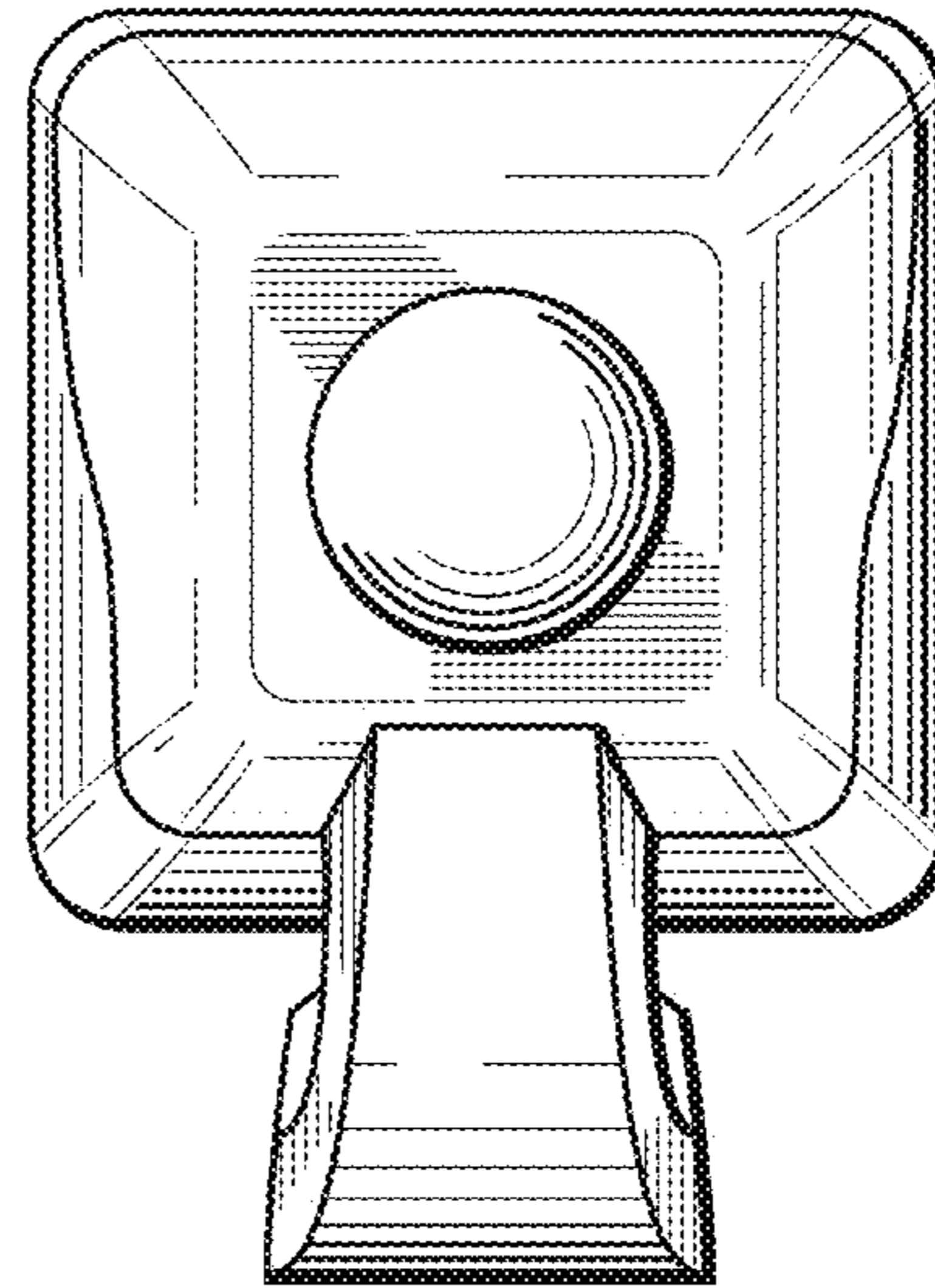

FIG. 2

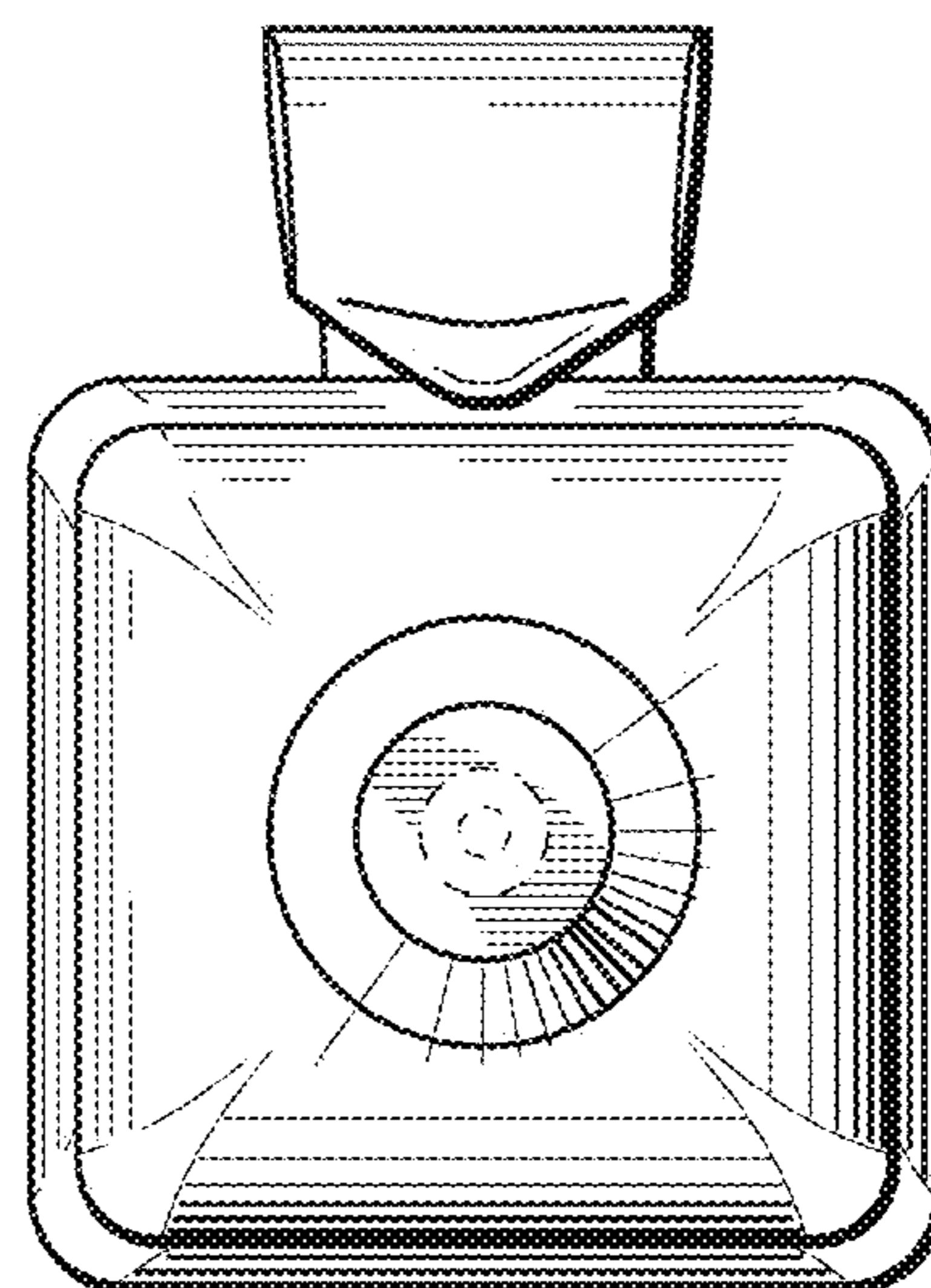

FIG. 3

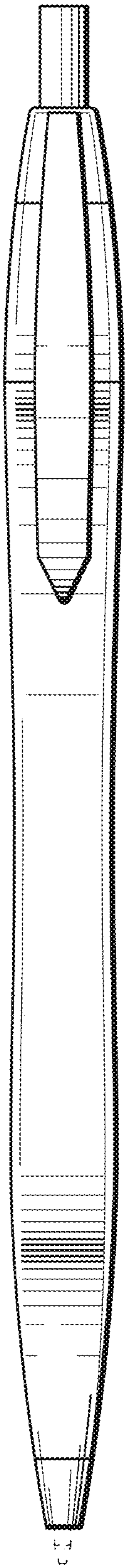

FIG. 4

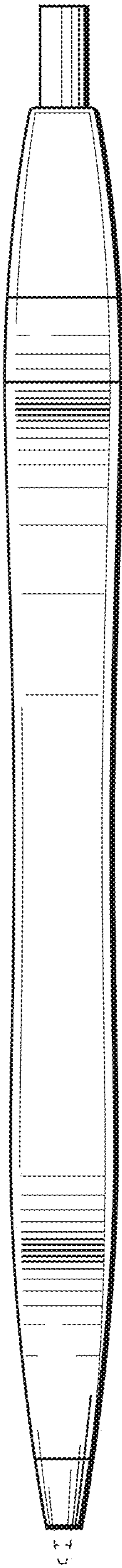

FIG. 5

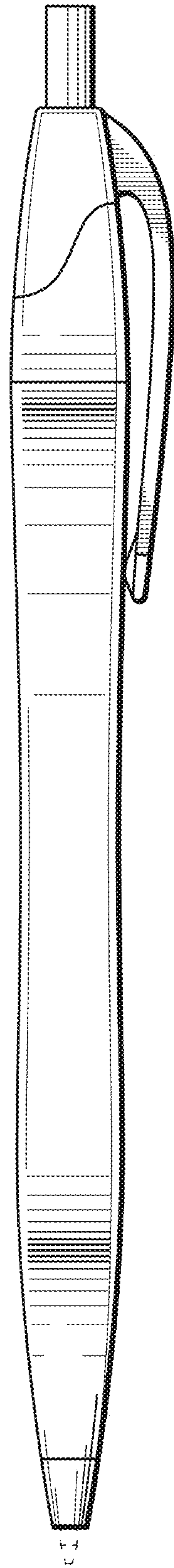

FIG. 6