



US00D925563S

(12) **United States Design Patent**
Melvin et al.

(10) **Patent No.:** **US D925,563 S**
(45) **Date of Patent:** **** Jul. 20, 2021**

(54) **DISPLAY SCREEN OR PORTION THEREOF WITH AN ANIMATED GRAPHICAL USER INTERFACE**

(71) Applicant: **Arrow Acquisition, LLC**, Lenexa, KS (US)

(72) Inventors: **Terrence S. Melvin**, Overland Park, KS (US); **Ross T. Gault**, Olathe, KS (US)

(73) Assignee: **ARROW ACQUISITION, LLC**, Lenexa, KS (US)

(**) Term: **15 Years**

(21) Appl. No.: **29/689,326**

(22) Filed: **Apr. 29, 2019**

(51) **LOC (13) Cl.** **14-04**

(52) **U.S. Cl.**
USPC **D14/486; D14/490**

(58) **Field of Classification Search**
USPC 345/1.1, 1.2, 2.1–2.3, 3.1, 902; 715/763, 715/810, 836, 837, 846, 847, 977; D14/485–495

(Continued)

(56) **References Cited**

U.S. PATENT DOCUMENTS

D316,875 S * 5/1991 Momot D20/12
D397,100 S * 8/1998 Branstetter D14/490

(Continued)

Primary Examiner — Cary M Robinson

(74) *Attorney, Agent, or Firm* — Husch Blackwell LLP

(57) **CLAIM**

The ornamental design for a display screen or portion thereof with an animated graphical user interface, as shown and described.

DESCRIPTION

The patent or application file contains at least one drawing executed in color. Copies of this patent or patent application

publication with color drawing(s) will be provided by the Office upon request and payment of the necessary fee.

FIG. 1 is a front view of the design of a display screen or portion thereof with an animated graphical user interface showing a first image of the new design;

FIG. 2 is a second image thereof;

FIG. 3 is a third image thereof;

FIG. 4 is a fourth image thereof;

FIG. 5 is a fifth image thereof;

FIG. 6 is a sixth image thereof;

FIG. 7 is a seventh image thereof;

FIG. 8 is an eighth image thereof;

FIG. 9 is a ninth image thereof;

FIG. 10 is a tenth image thereof;

FIG. 11 is an eleventh image thereof;

FIG. 12 is a twelfth image thereof;

FIG. 13 is a thirteenth image thereof;

FIG. 14 is a fourteenth image thereof;

FIG. 15 is a fifteenth image thereof;

FIG. 16 is a front view of the design of a display screen or portion thereof with an animated graphical user interface showing a first image of the new design in an exemplary use environment;

FIG. 17 is a second image thereof;

FIG. 18 is a third image thereof;

FIG. 19 is a fourth image thereof;

FIG. 20 is a fifth image thereof;

FIG. 21 is a sixth image thereof;

FIG. 22 is a seventh image thereof;

FIG. 23 is an eighth image thereof;

FIG. 24 is a ninth image thereof;

FIG. 25 is a tenth image thereof;

FIG. 26 is an eleventh image thereof;

FIG. 27 is a twelfth image thereof;

FIG. 28 is a thirteenth image thereof;

FIG. 29 is a fourteenth image thereof; and,

FIG. 30 is a fifteenth image thereof.

The outermost broken lines in the figures show a display screen or portion thereof with an animated graphical user interface and form no part of the claimed design. The other broken lines in the figures show portions of the dynamic graphical user interface that form no part of the claimed design.

(Continued)

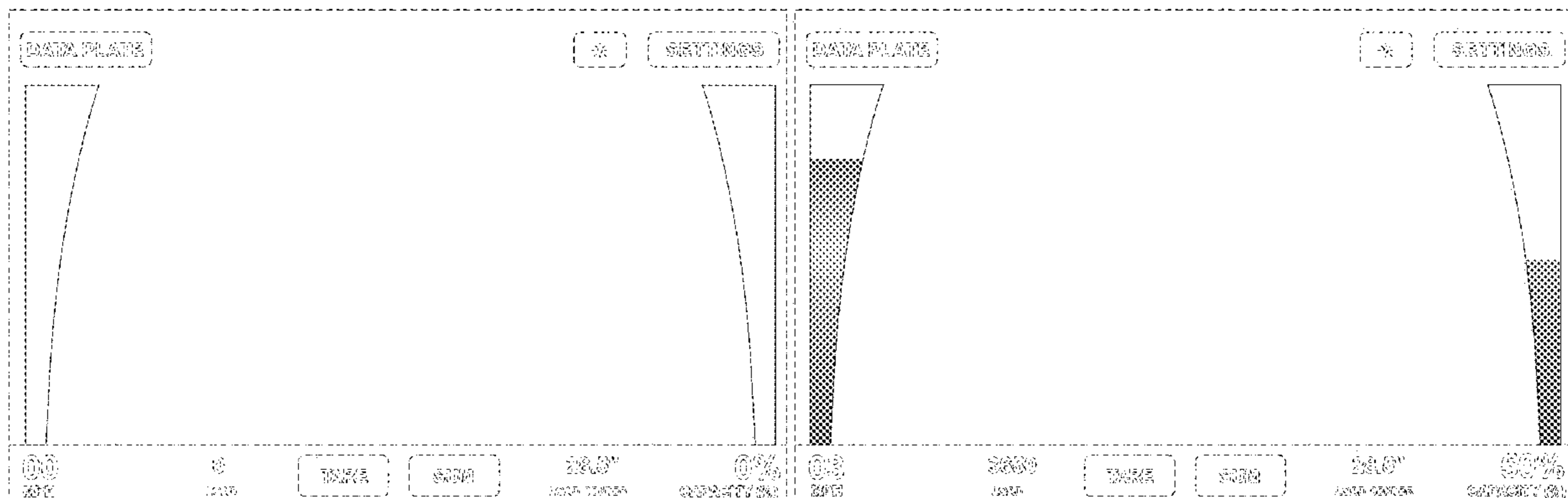

The appearance of the dynamic images transitions between the claimed images shown in FIGS. 1-15 and FIGS. 16-30. The process or period in which one image transitions to another forms no part of the claimed design.

**1 Claim, 30 Drawing Sheets
(26 of 30 Drawing Sheet(s) Filed in Color)**

(58) Field of Classification Search

CPC B60K 37/00; G06F 3/048-04897; G06F 3/013; G06F 3/017; G06F 3/165; G06F 16/168; G06F 16/7335; G06F 17/212; G06F 2203/014; G06F 2206/1008; G06F 2209/545; G06F 30/12; G06T 13/80; G06T 15/02; G06Q 10/10; H04M 1/6075; H04M 3/567; H04M 1/2477; H04M 1/26; H04L 12/581; H04L 12/1813; H04N 7/16

See application file for complete search history.

(56) References Cited

U.S. PATENT DOCUMENTS

D563,977 S * 3/2008 Carl D14/488
D601,578 S * 10/2009 Poulet D14/488

D605,201 S * 12/2009 Lorenz D14/488
D686,240 S * 7/2013 Lin D14/488
D747,325 S * 1/2016 Yoo G06F 3/04817
D14/485
D750,119 S * 2/2016 Agarwal D14/486
D758,409 S * 6/2016 Aoshima D14/487
D759,112 S * 6/2016 Riske D14/490
D763,915 S * 8/2016 Puzio D14/490
D773,483 S * 12/2016 Leventhal D14/485
D781,885 S * 3/2017 Bhat D14/486
D801,988 S * 11/2017 Safir D14/485
D835,150 S * 12/2018 Oshima D14/488
D849,789 S * 5/2019 Rottmann D14/490
D879,143 S * 3/2020 Reichert D14/490
D879,809 S * 3/2020 Harris D14/486
D881,913 S * 4/2020 Harry D14/486
D890,196 S * 7/2020 Mathen D14/486
D890,207 S * 7/2020 Kentley-Klay D14/490
D905,104 S * 12/2020 Katz D14/490
D905,106 S * 12/2020 Kang D14/490
D914,754 S * 3/2021 Albrecht D14/490
2010/0211237 A1 * 8/2010 Nichols G08G 5/0021
701/14
2015/0175397 A1 * 6/2015 Lynn G06F 3/04886
187/222

* cited by examiner

FIG. 1

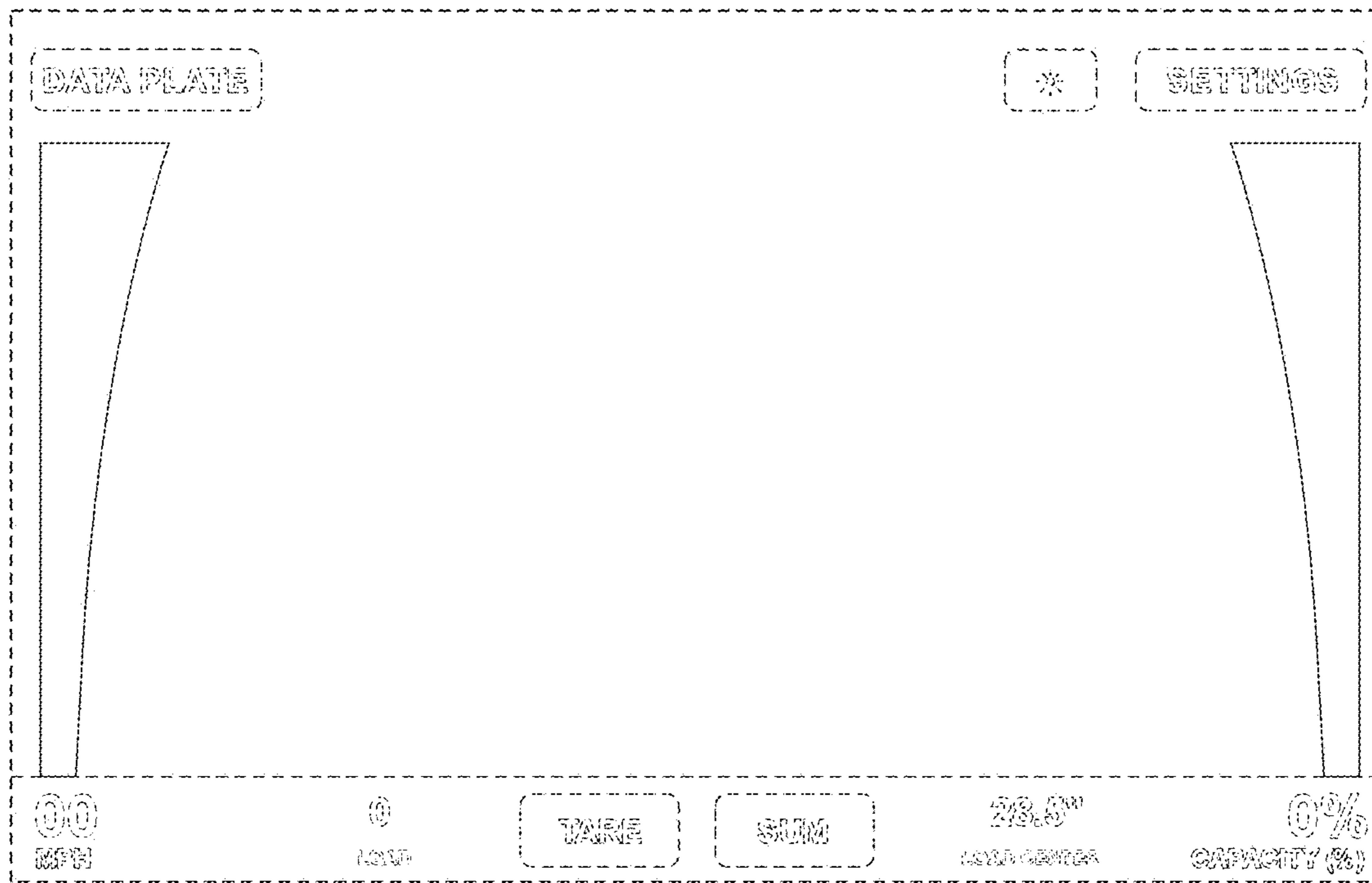

FIG. 2

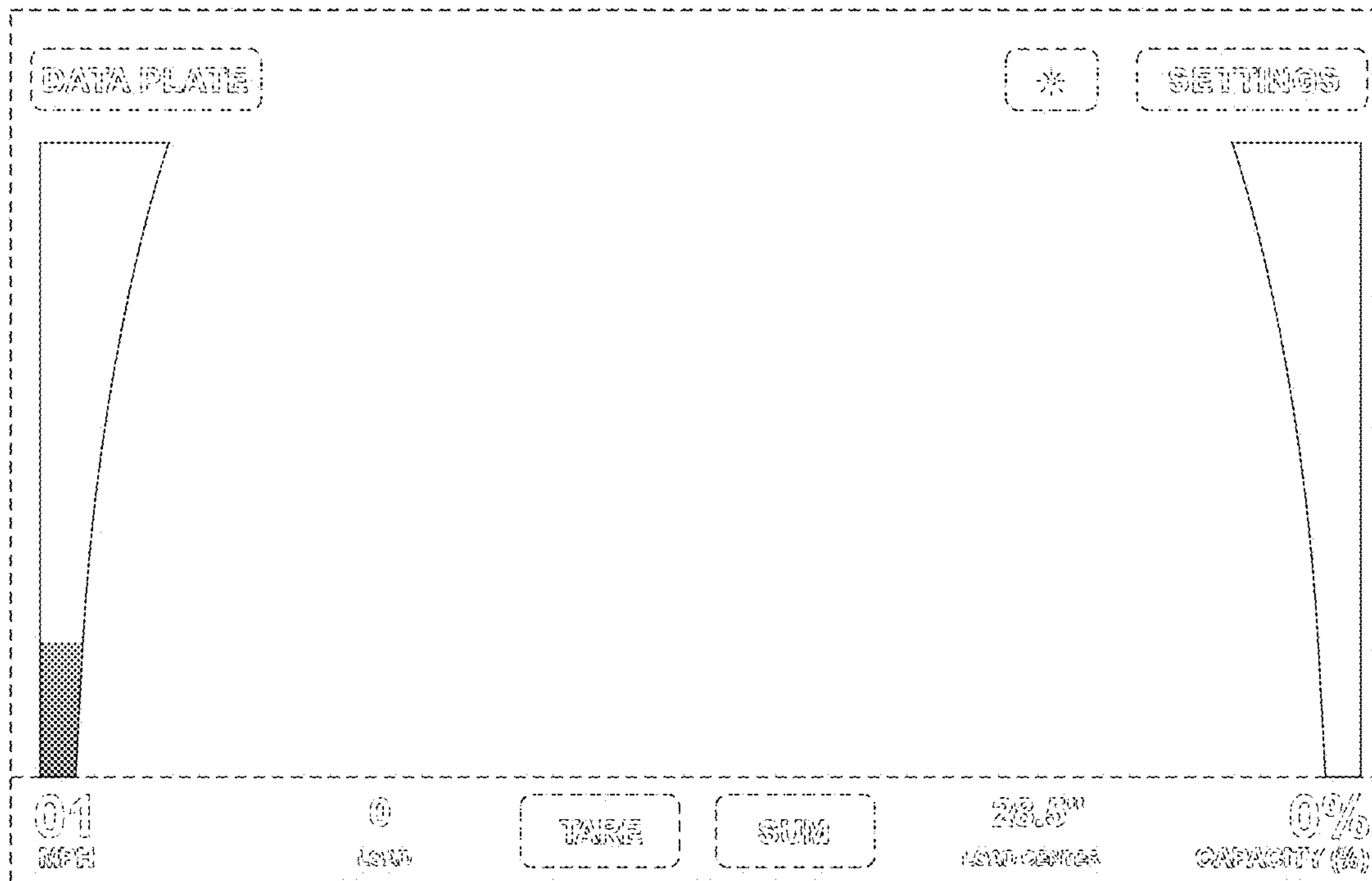

FIG. 3

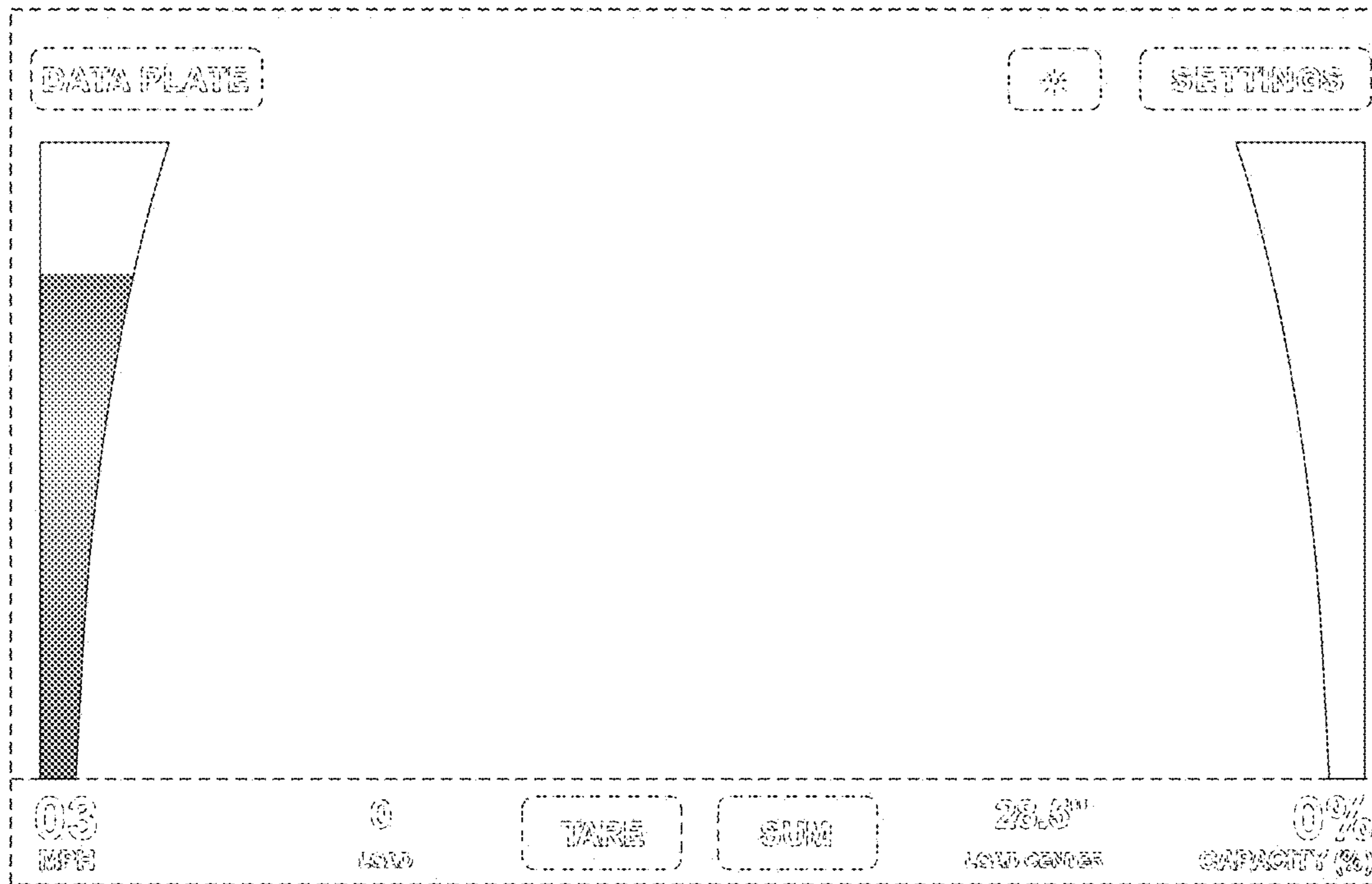

FIG. 4

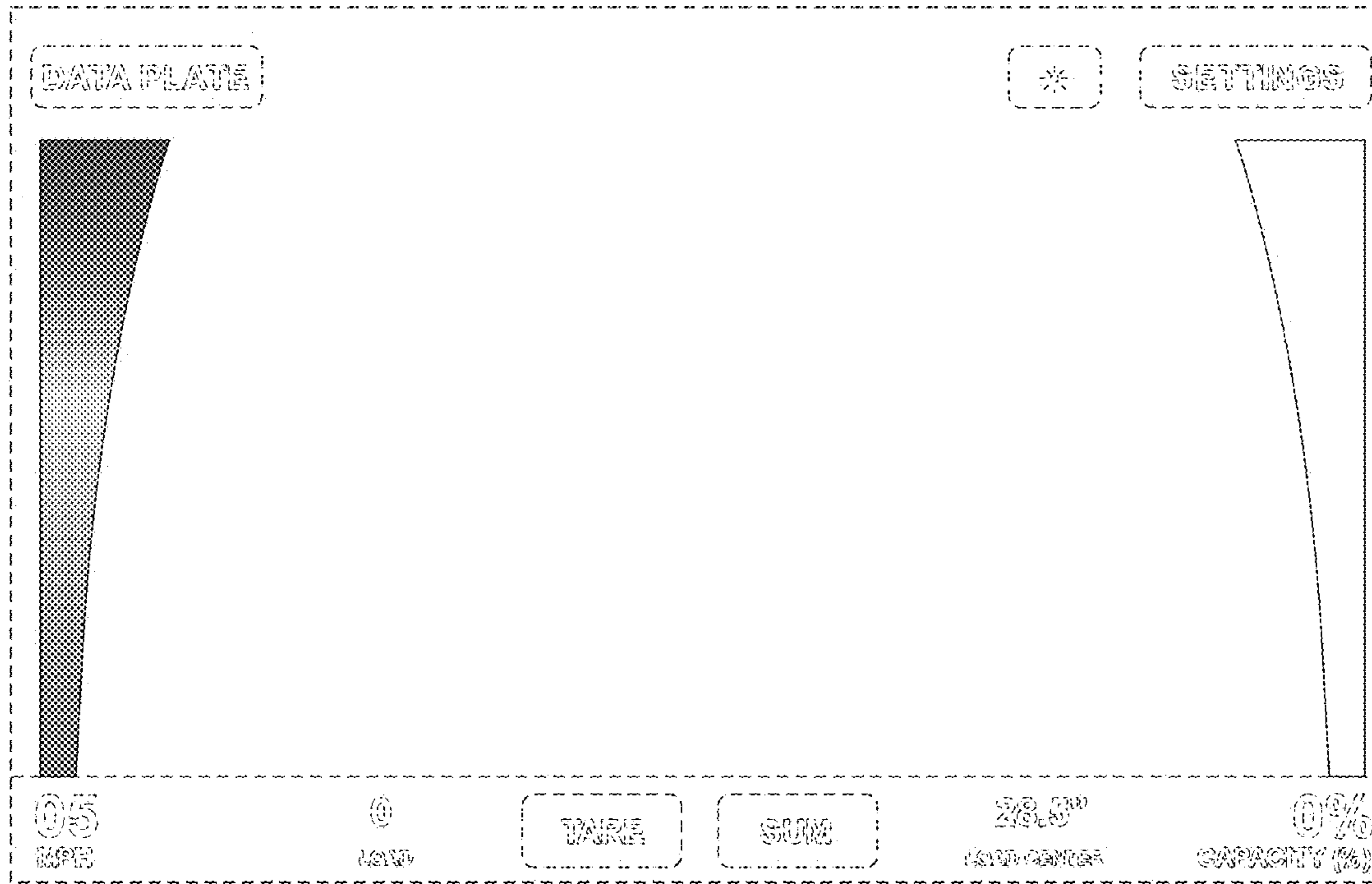

FIG. 5

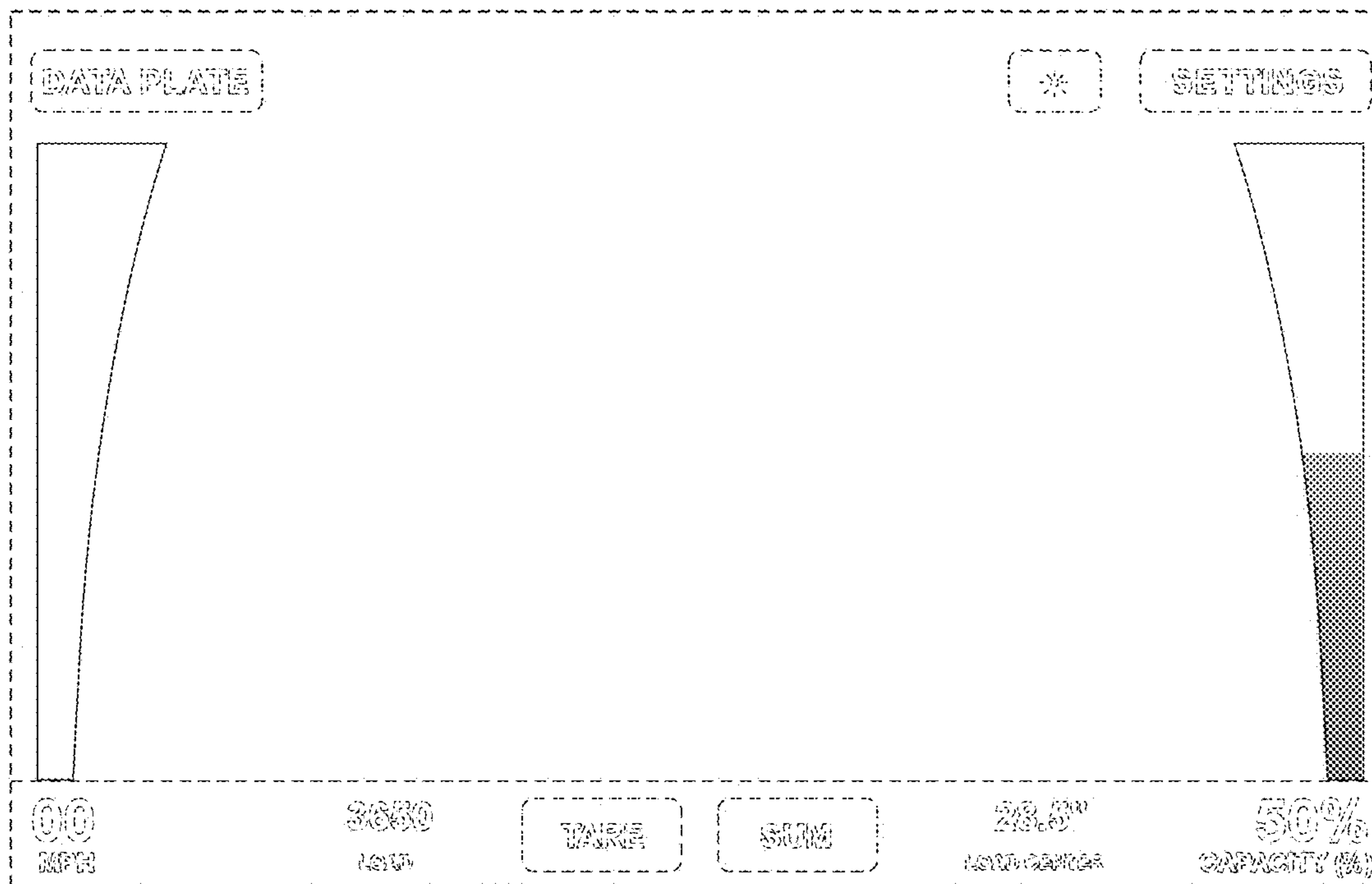

FIG. 6

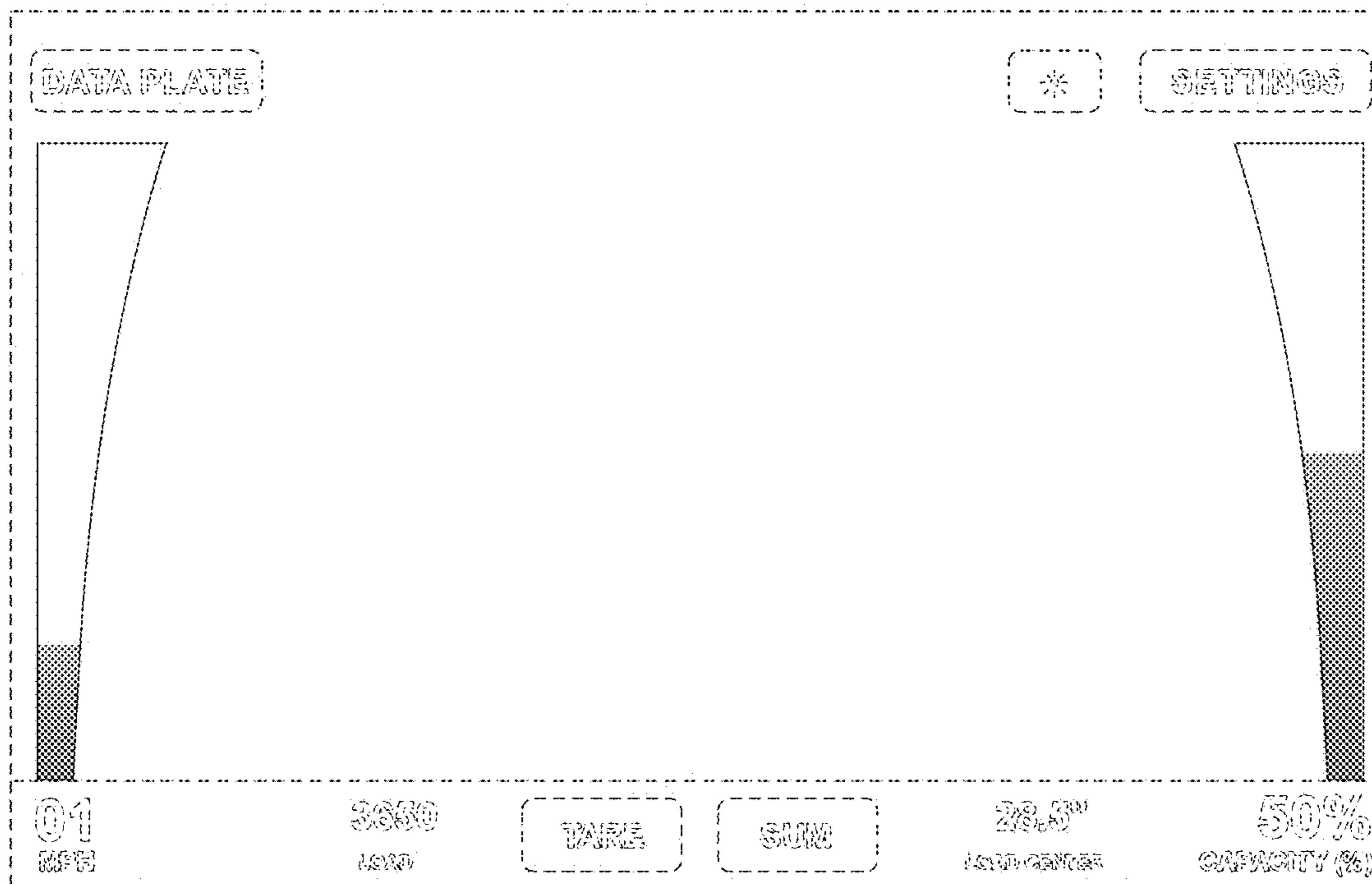

FIG. 7

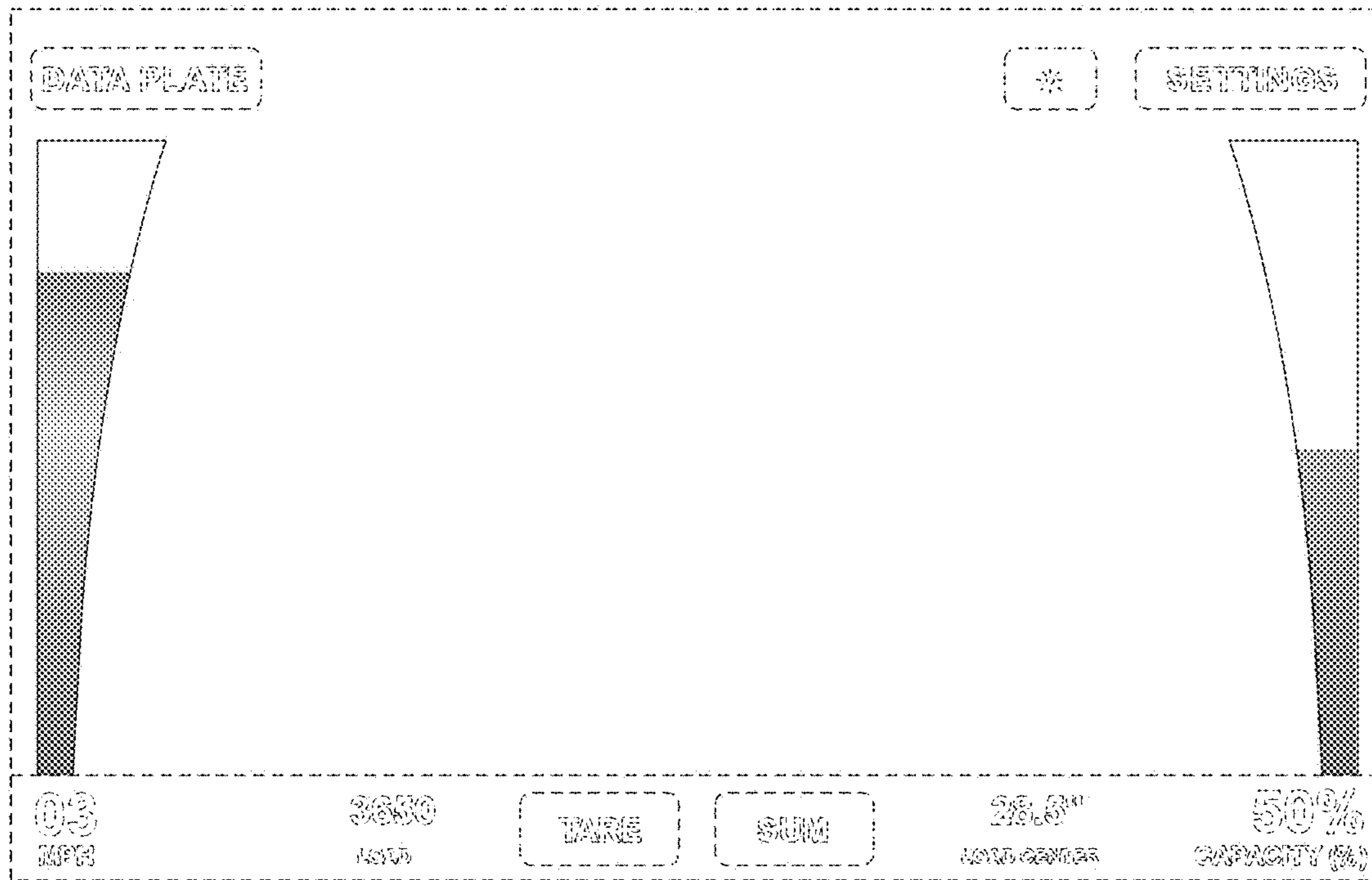

FIG. 8

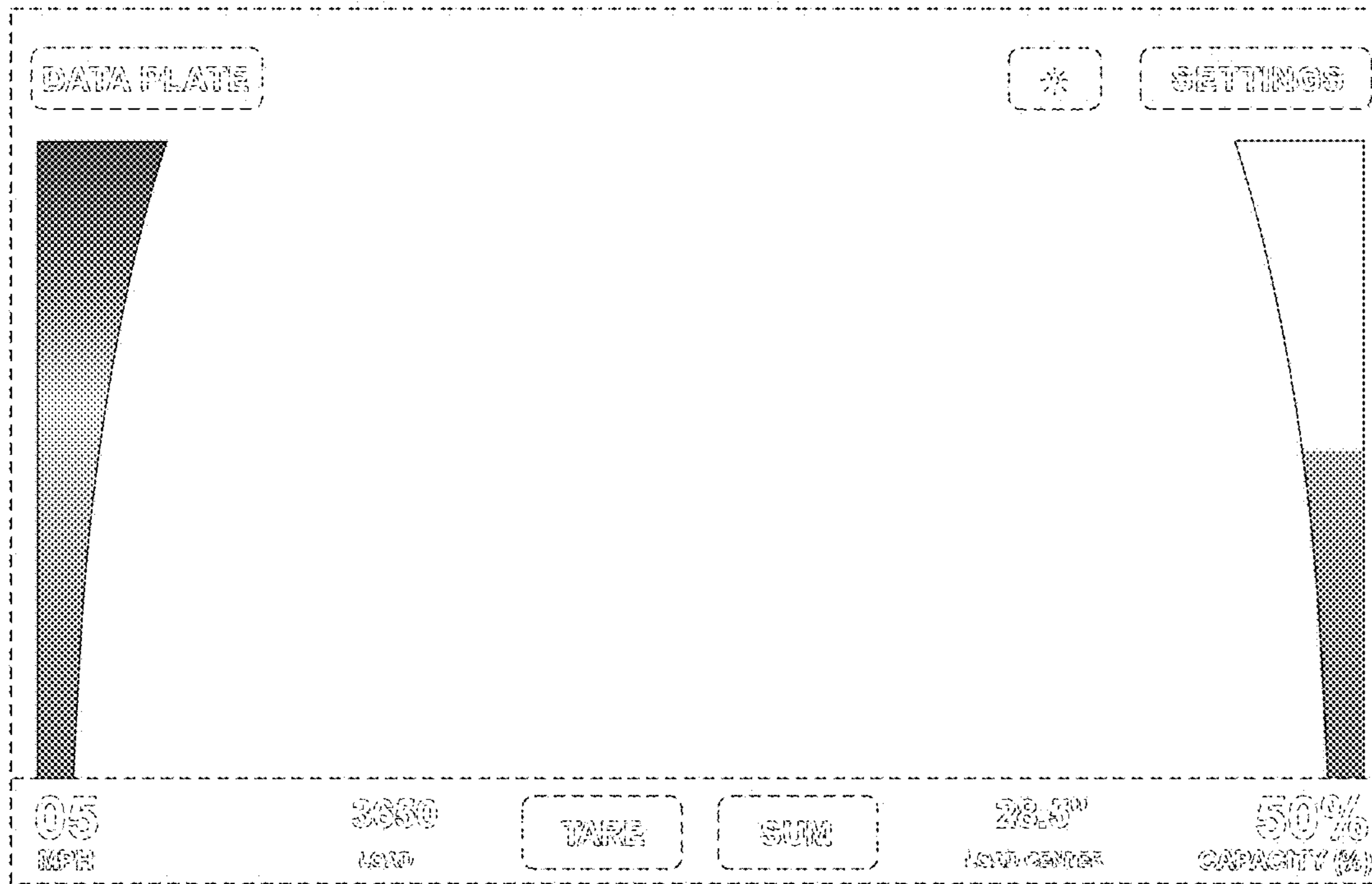

FIG. 9

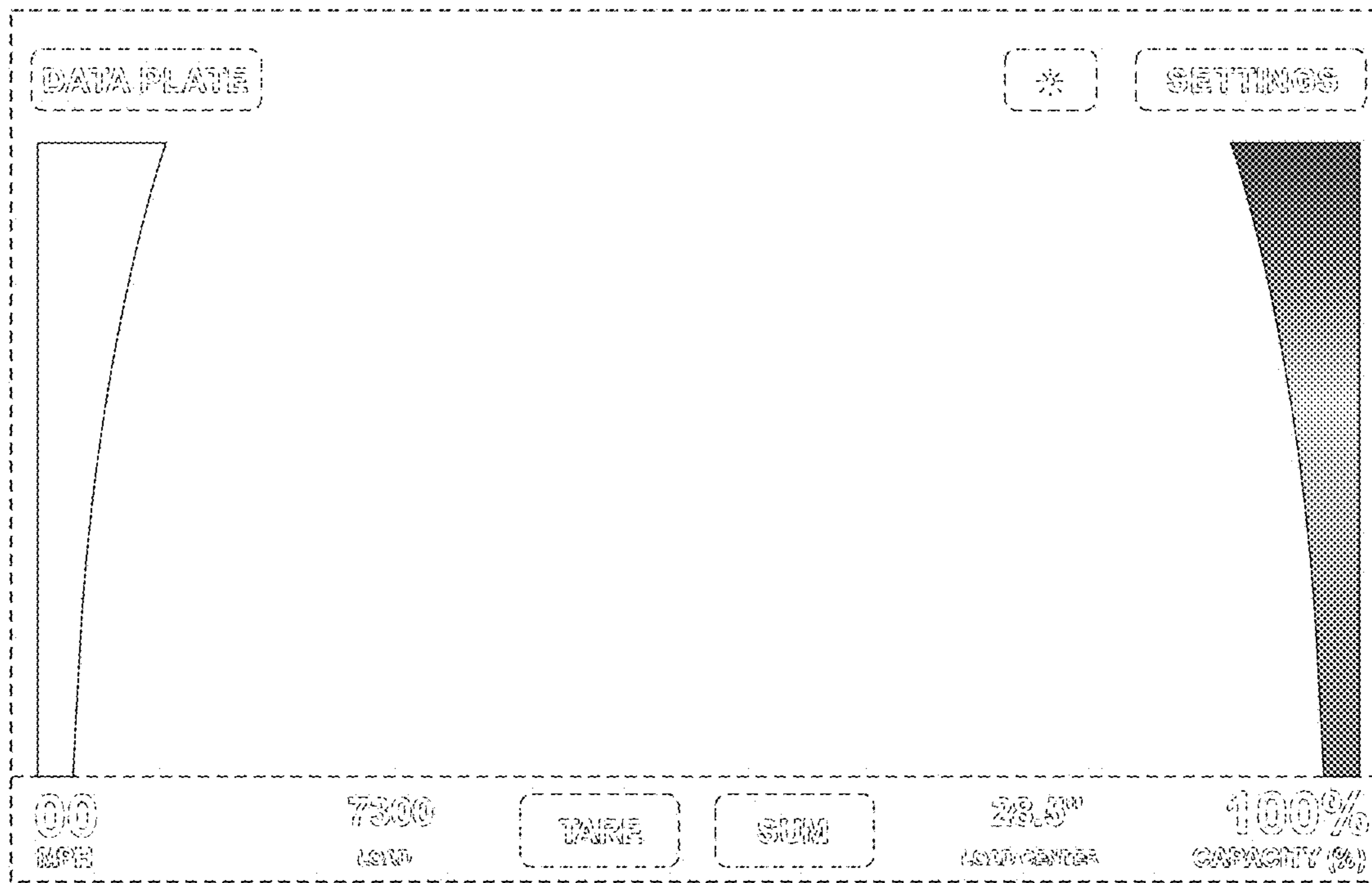

FIG. 10

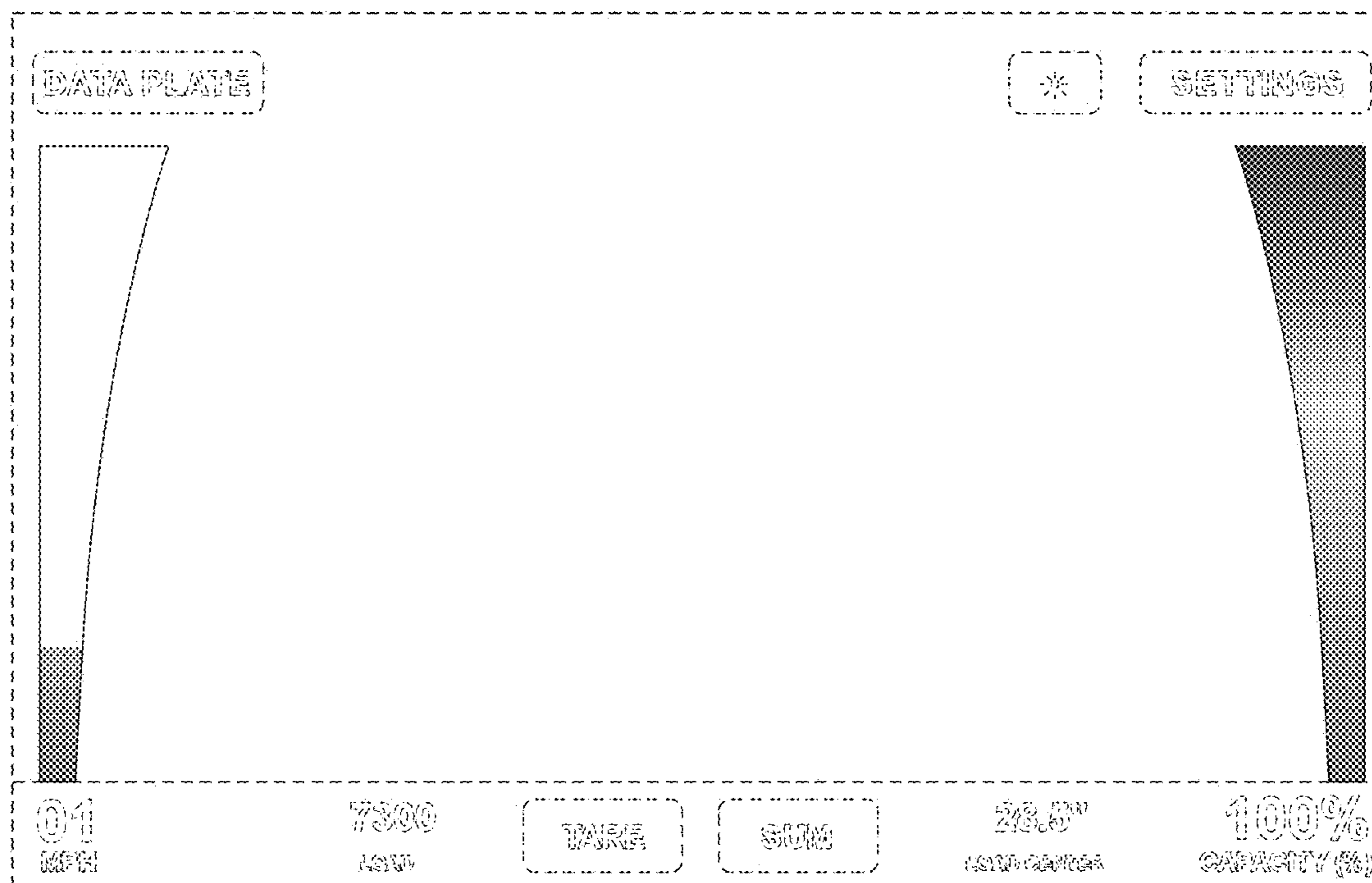

FIG. 11

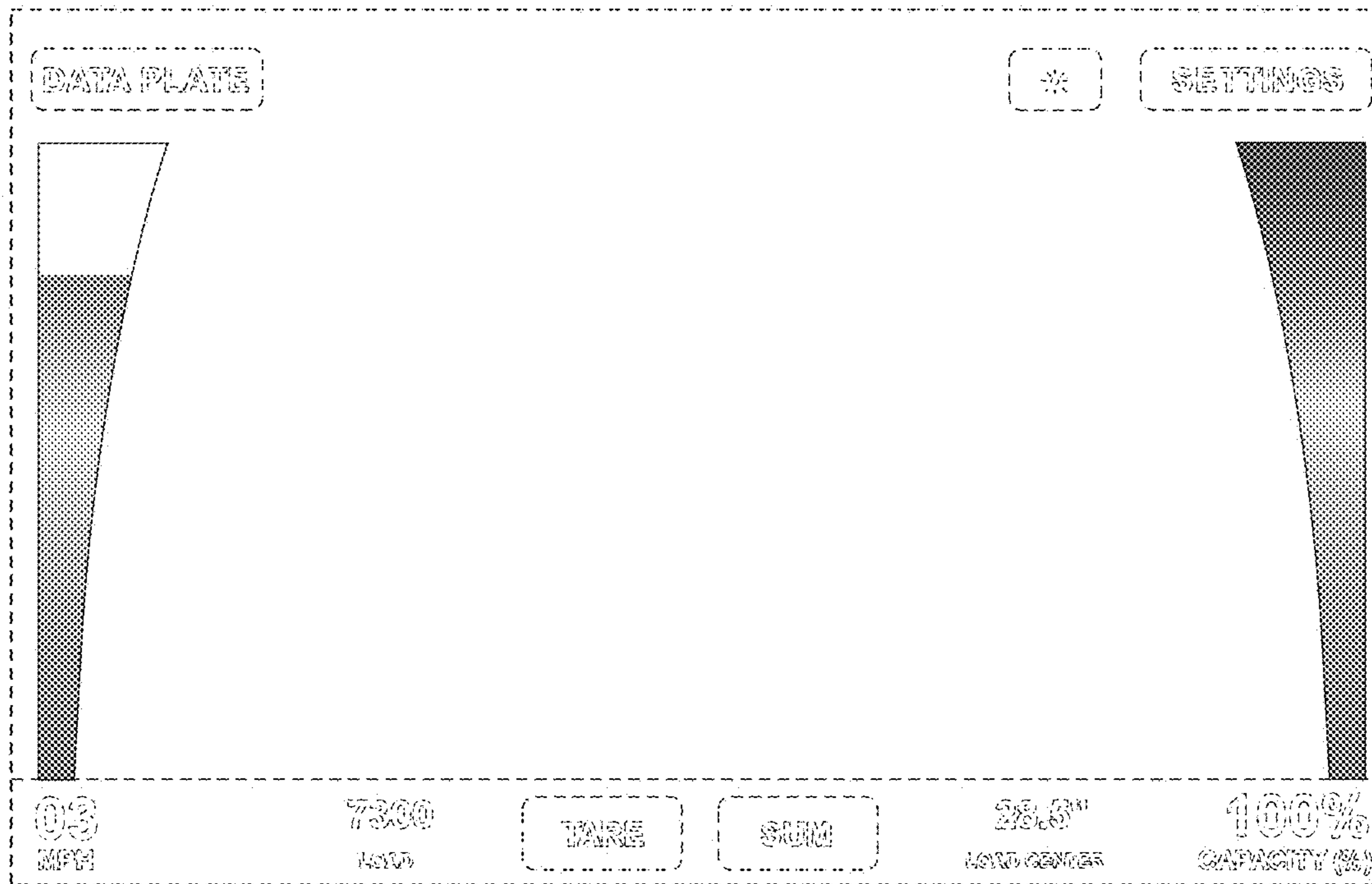

FIG. 12

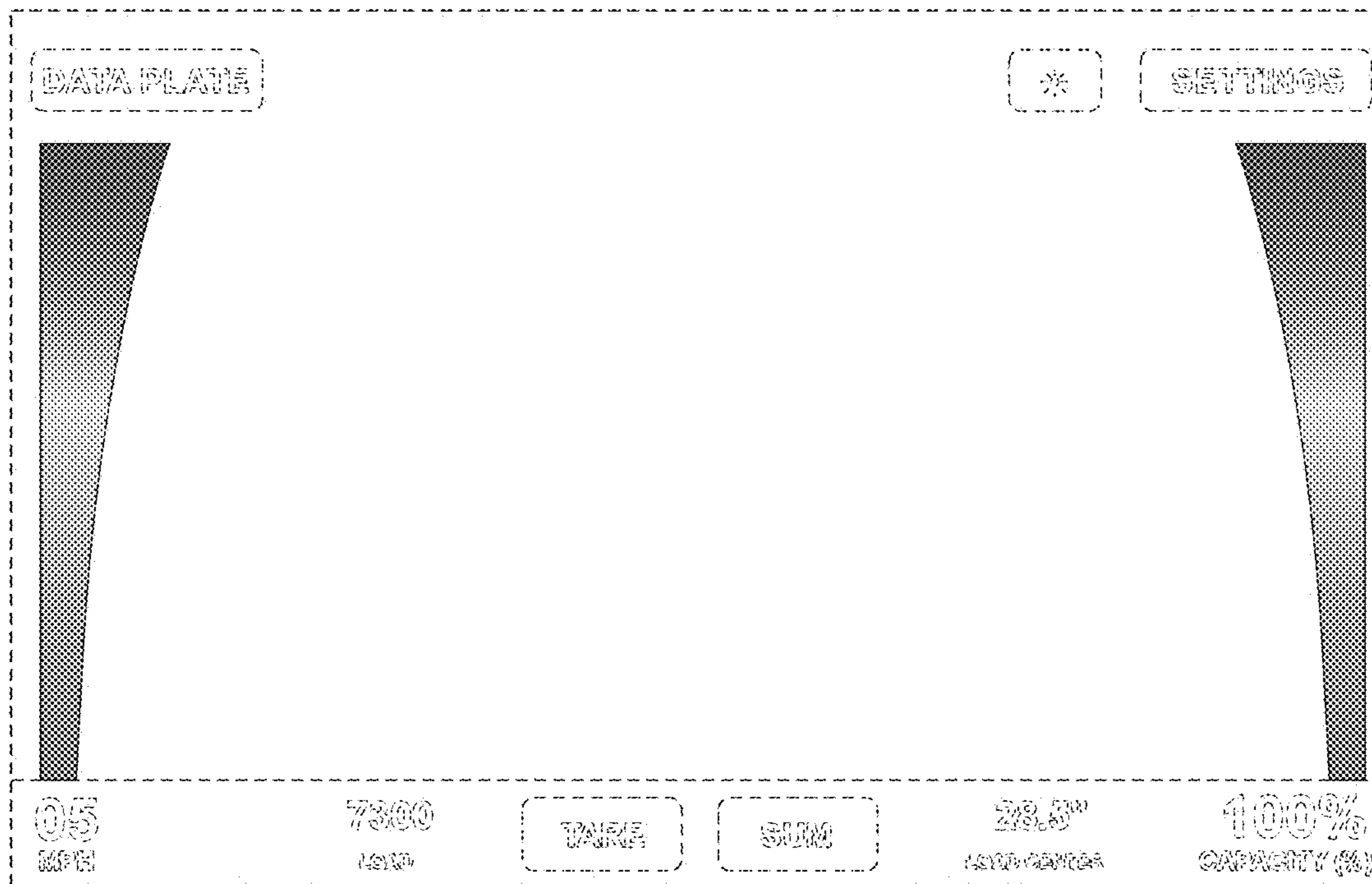

FIG. 13

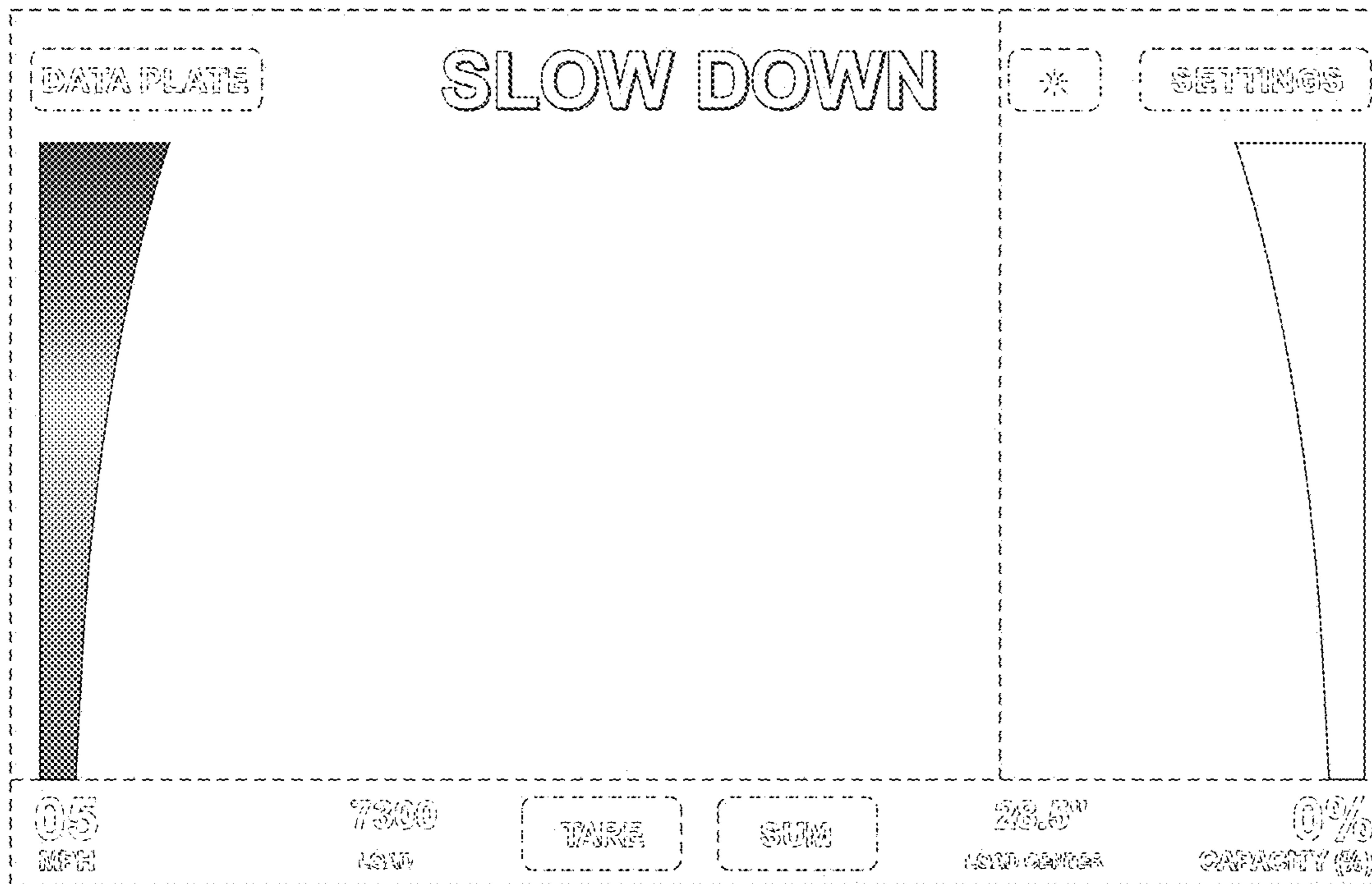

FIG. 14

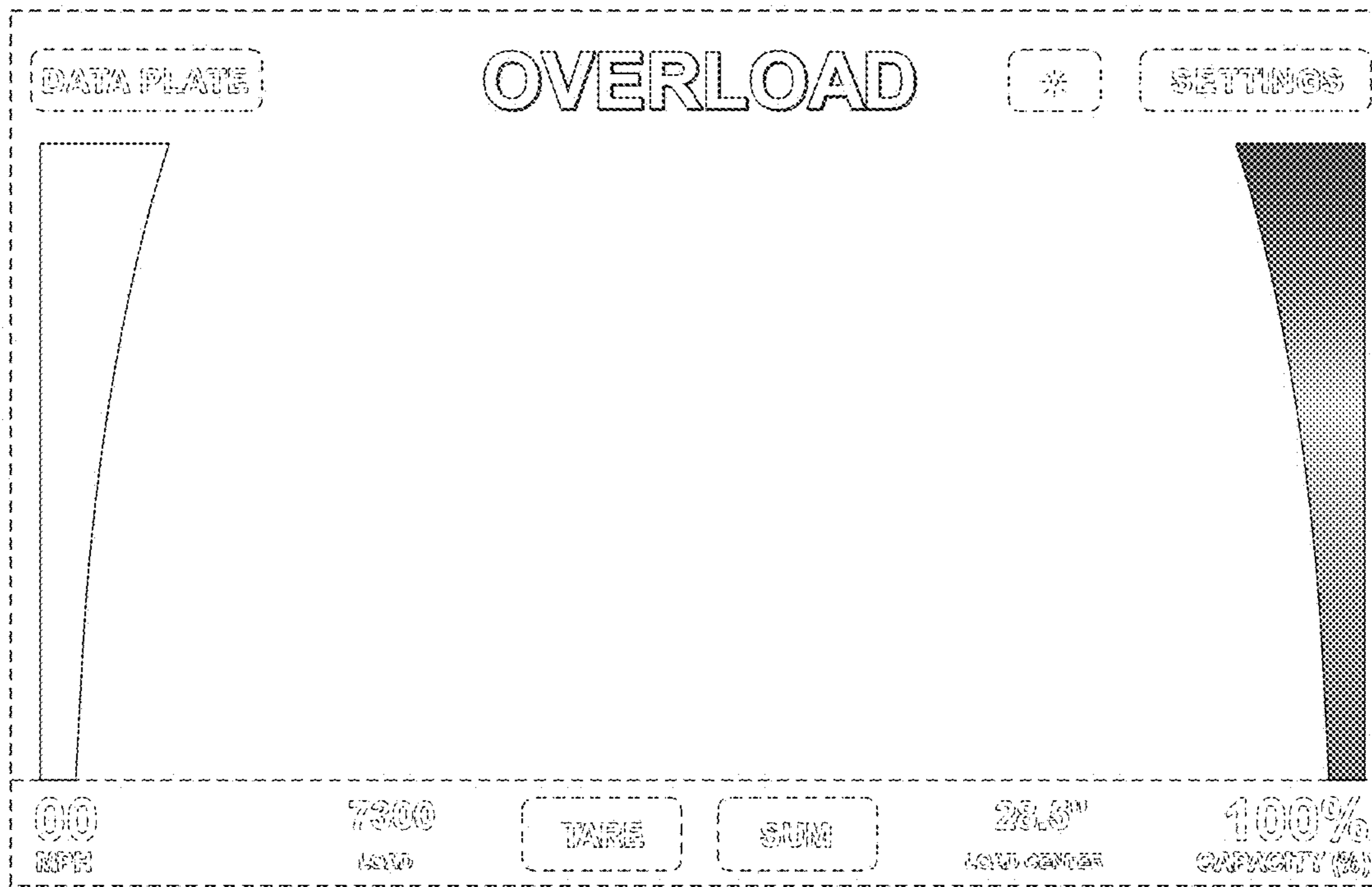

FIG. 15

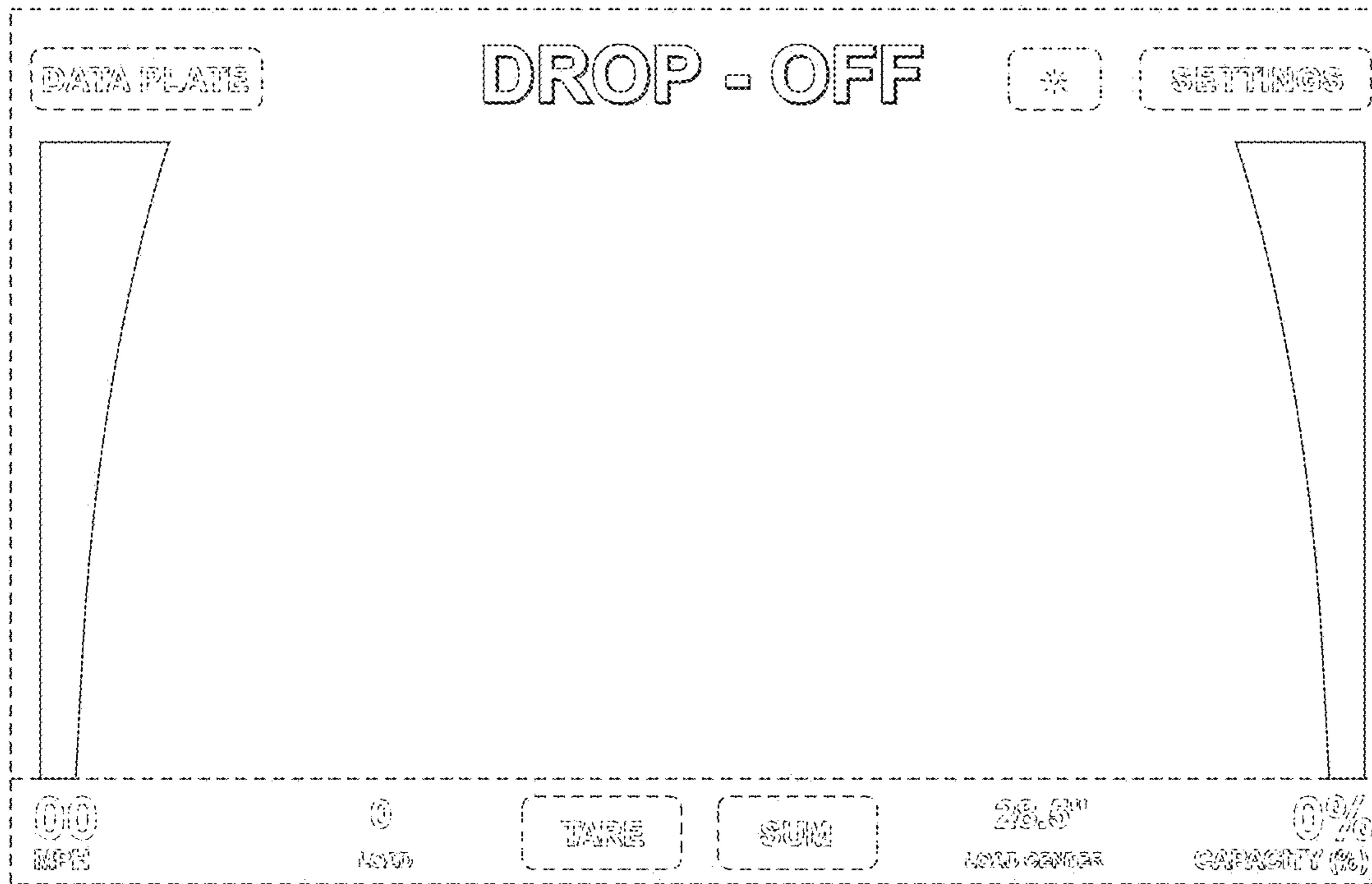

FIG. 16

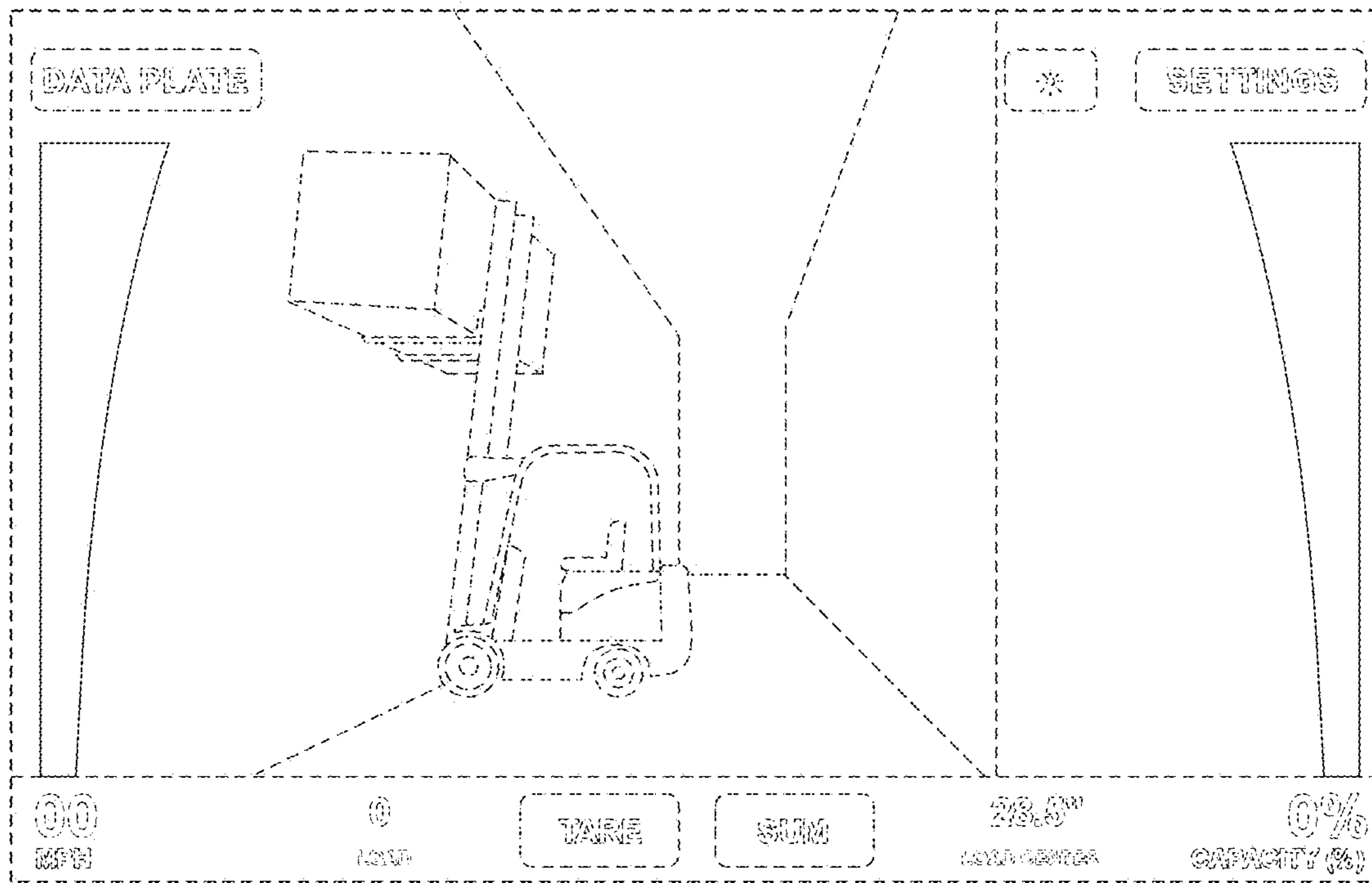

FIG. 17

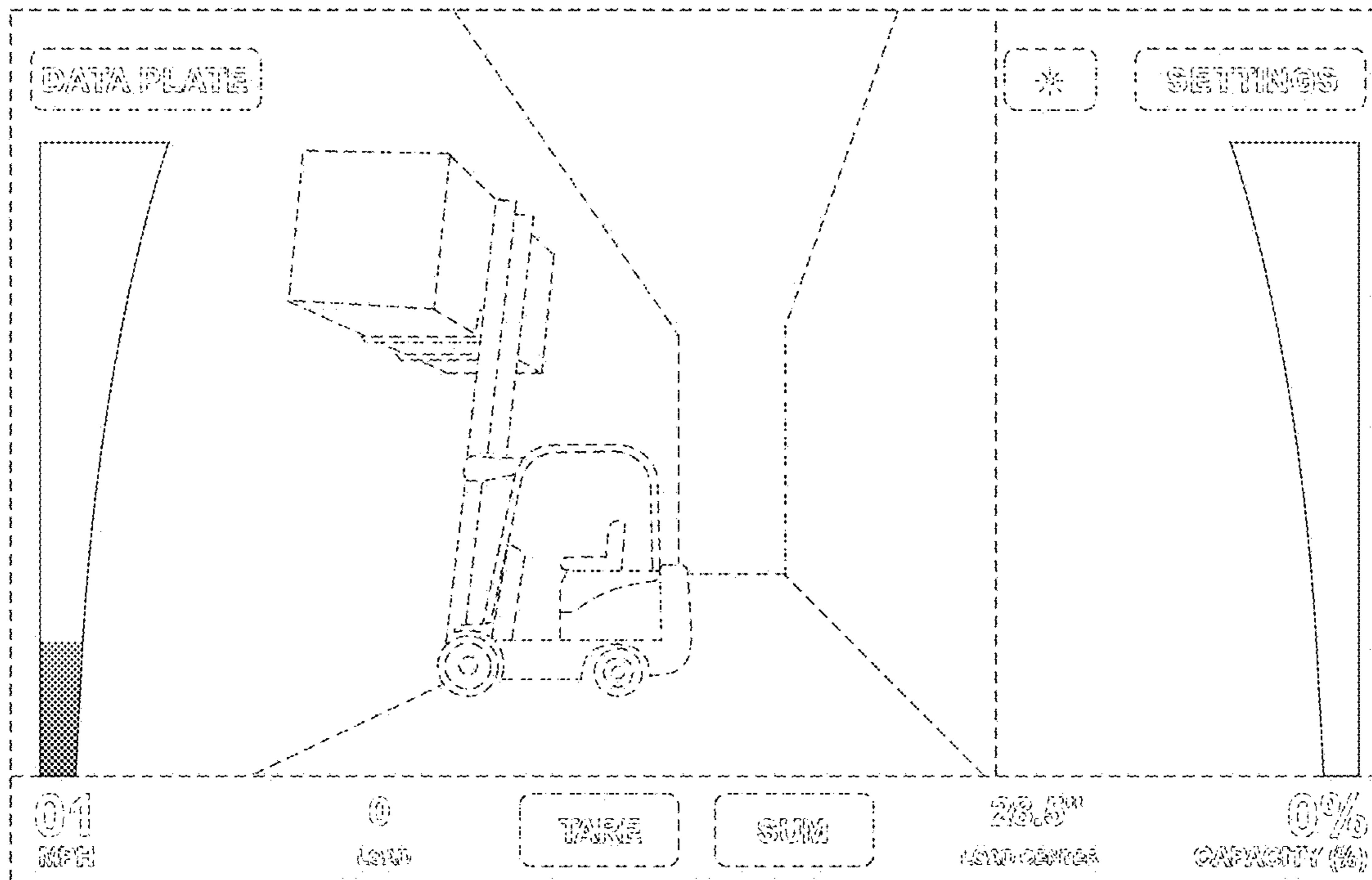

FIG. 18

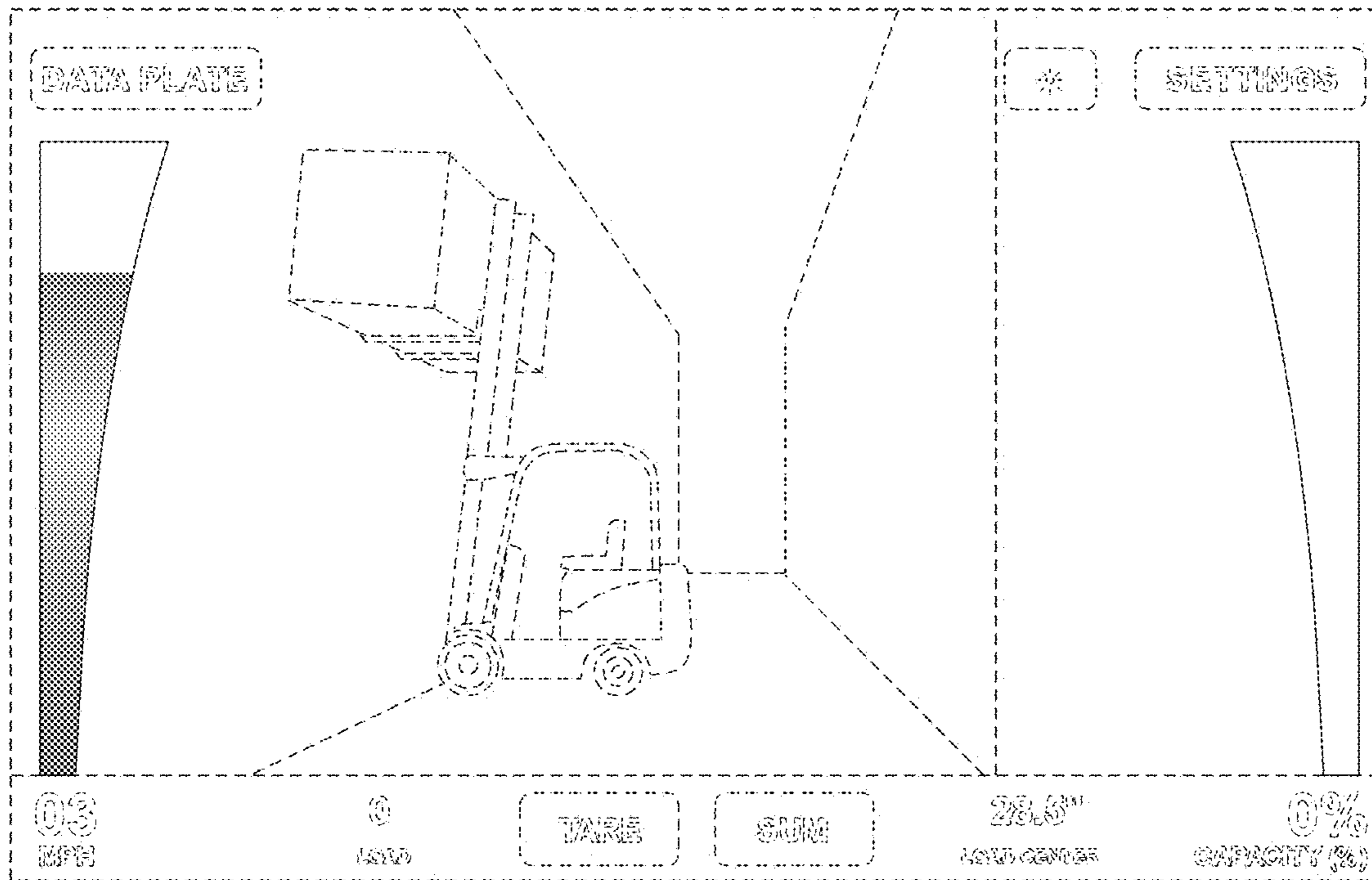

FIG. 19

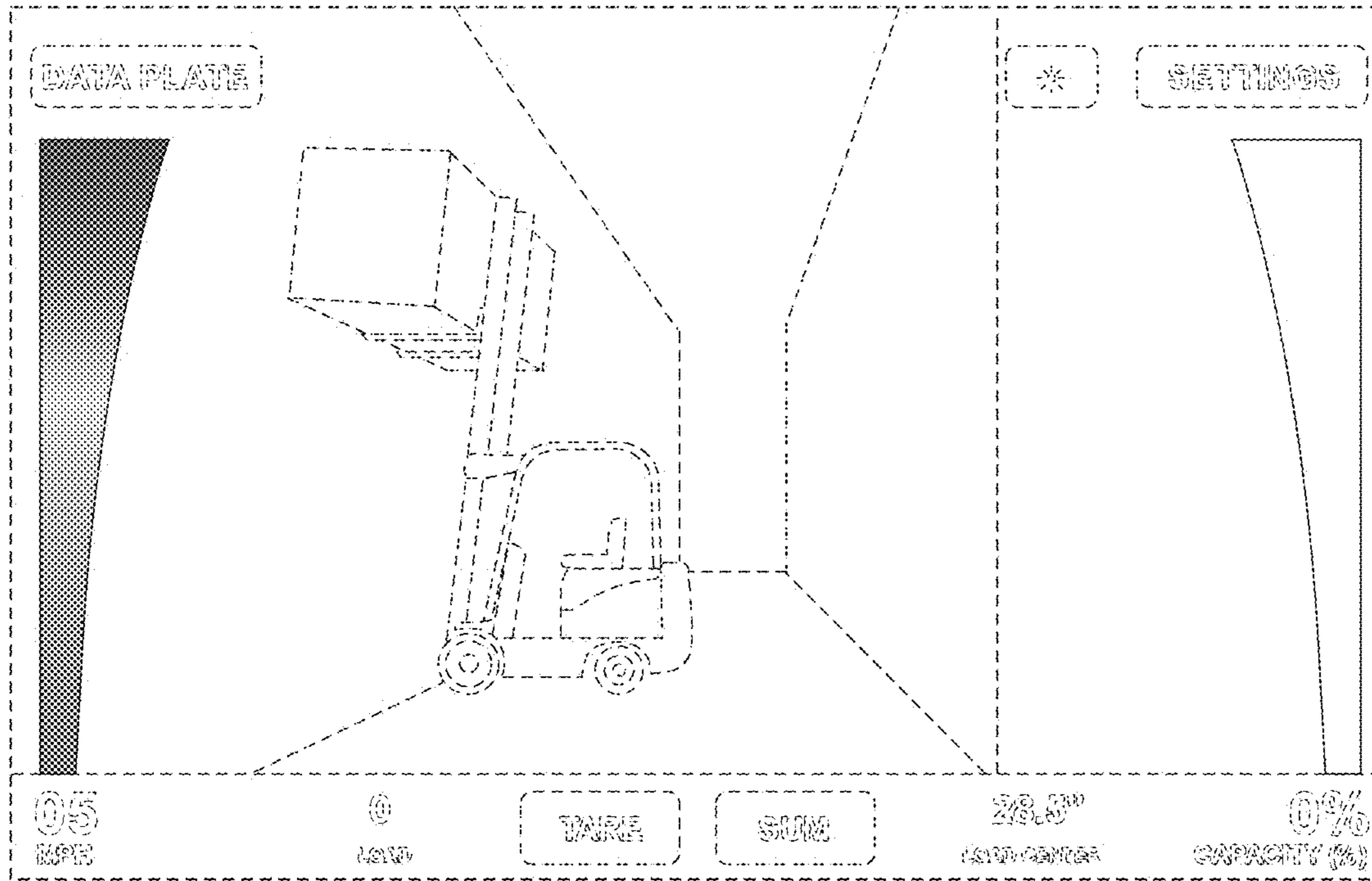

FIG. 20

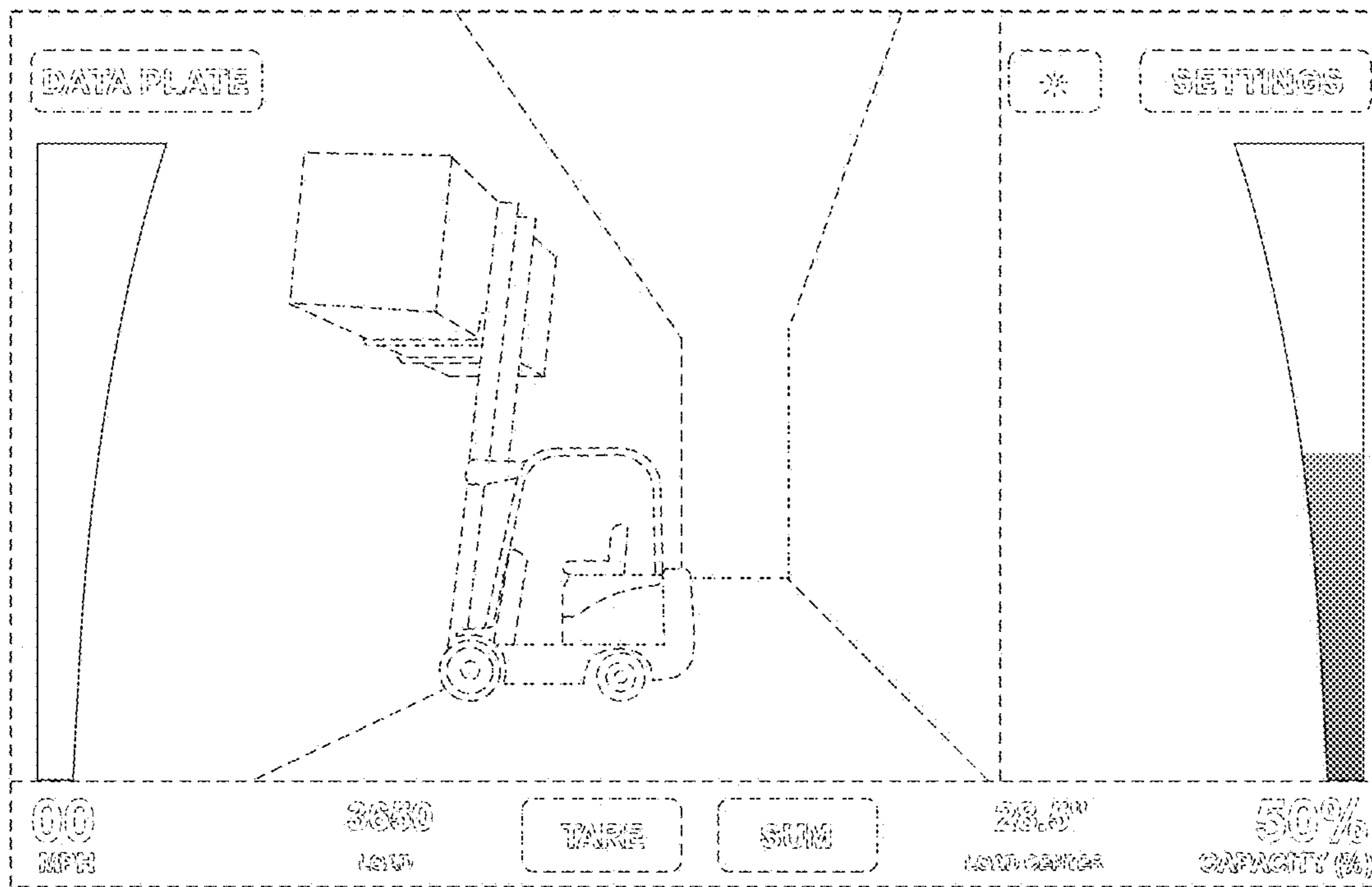

FIG. 21

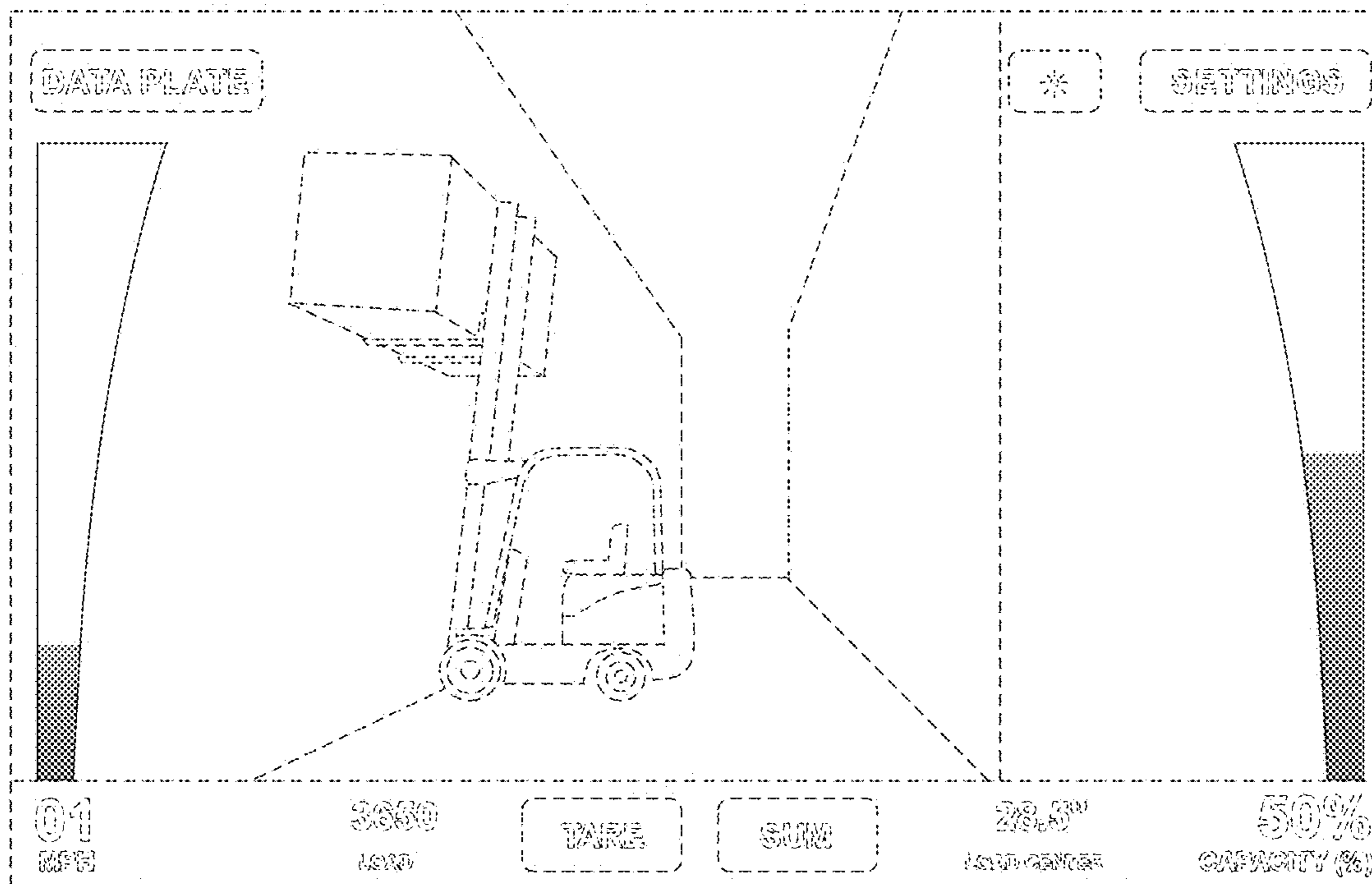

FIG. 22

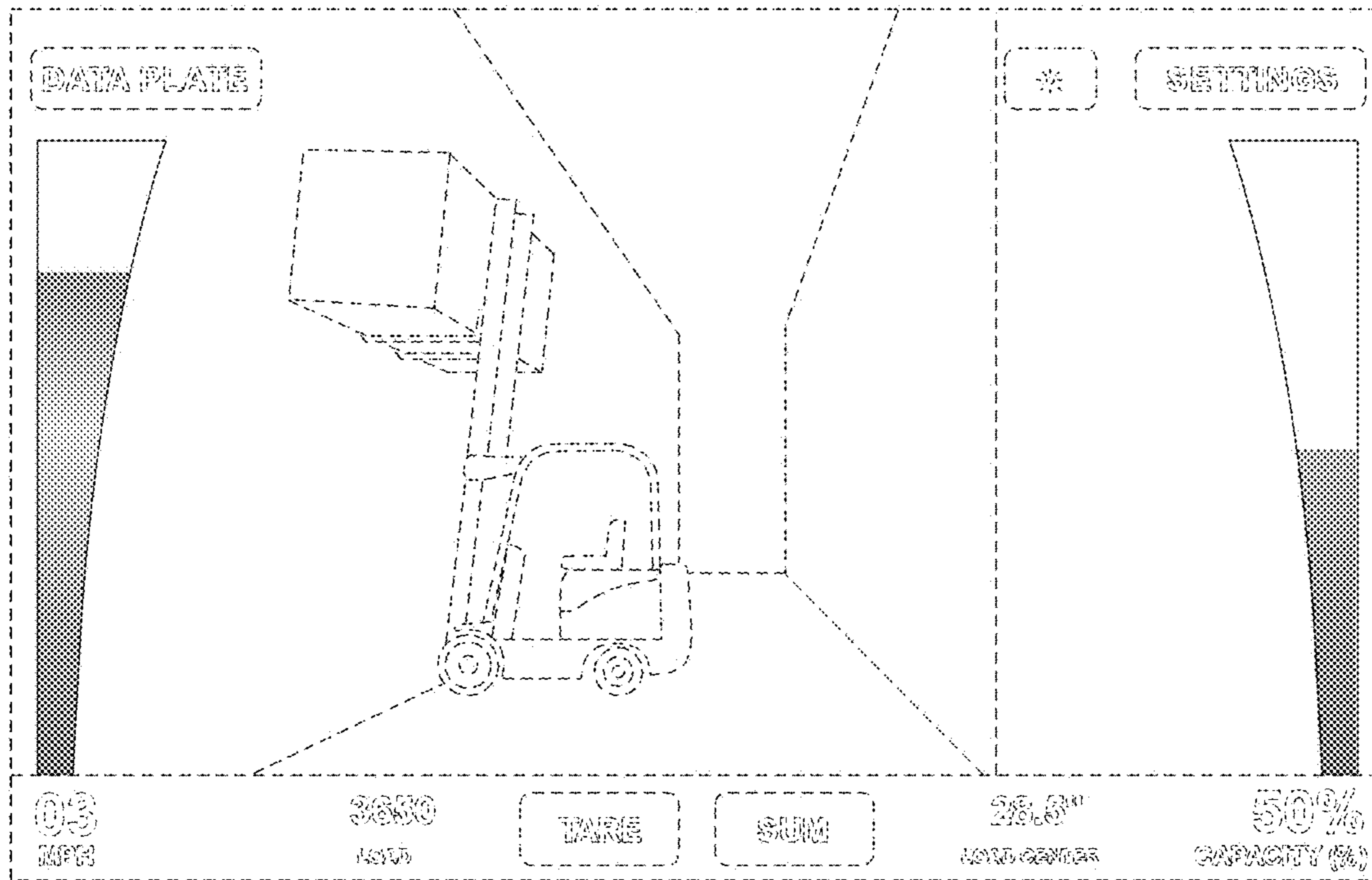

FIG. 23

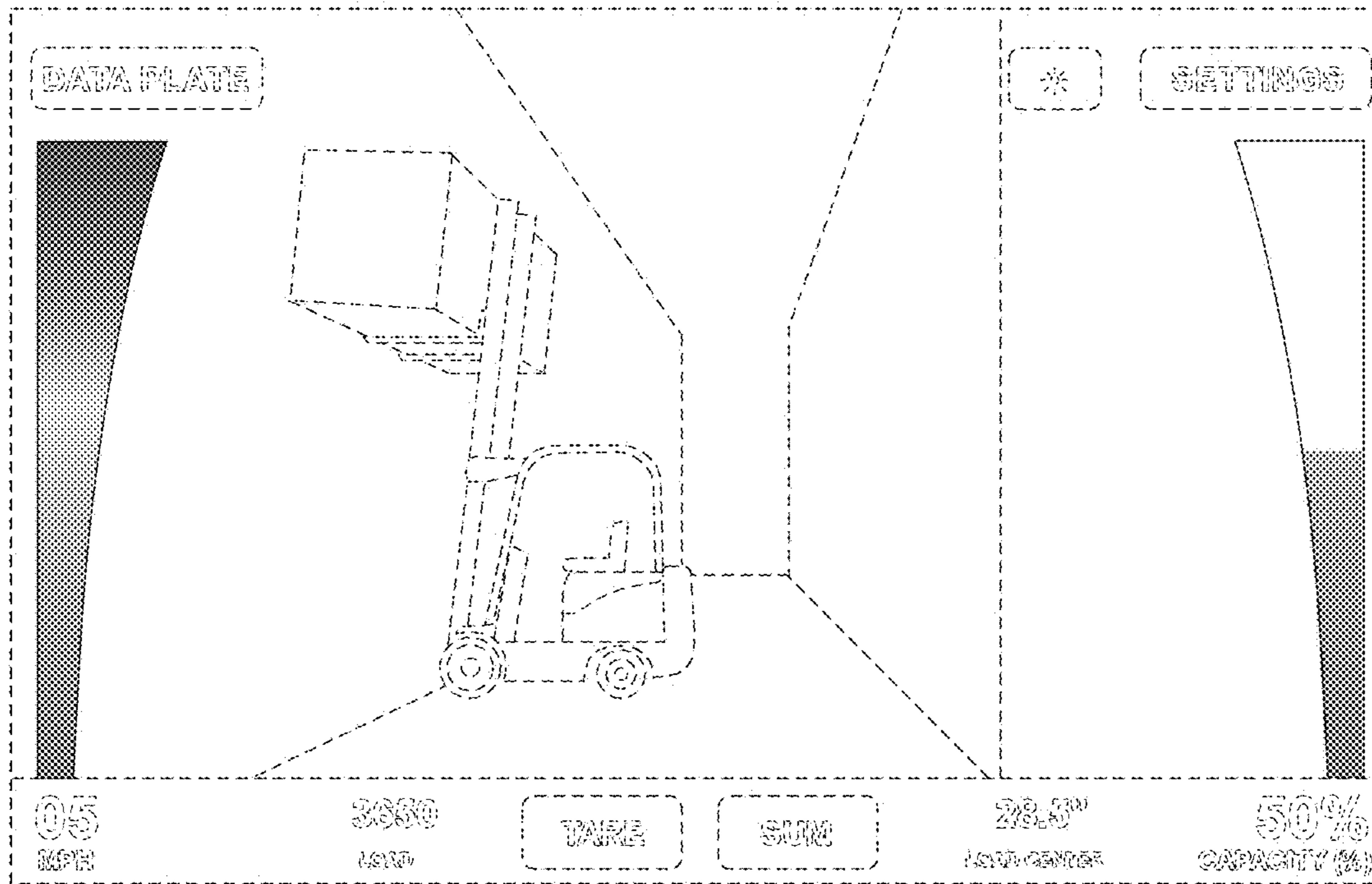

FIG. 24

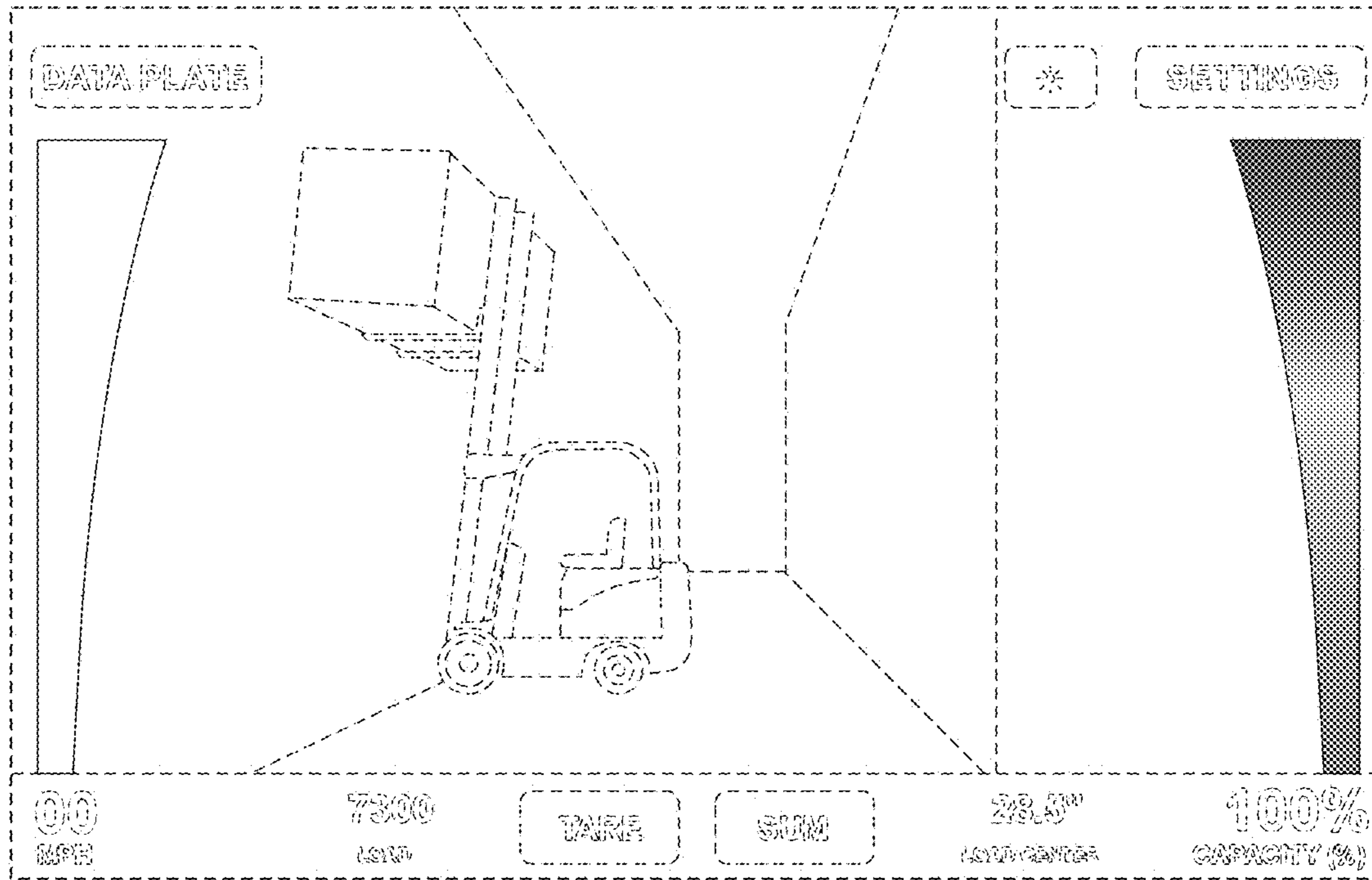

FIG. 25

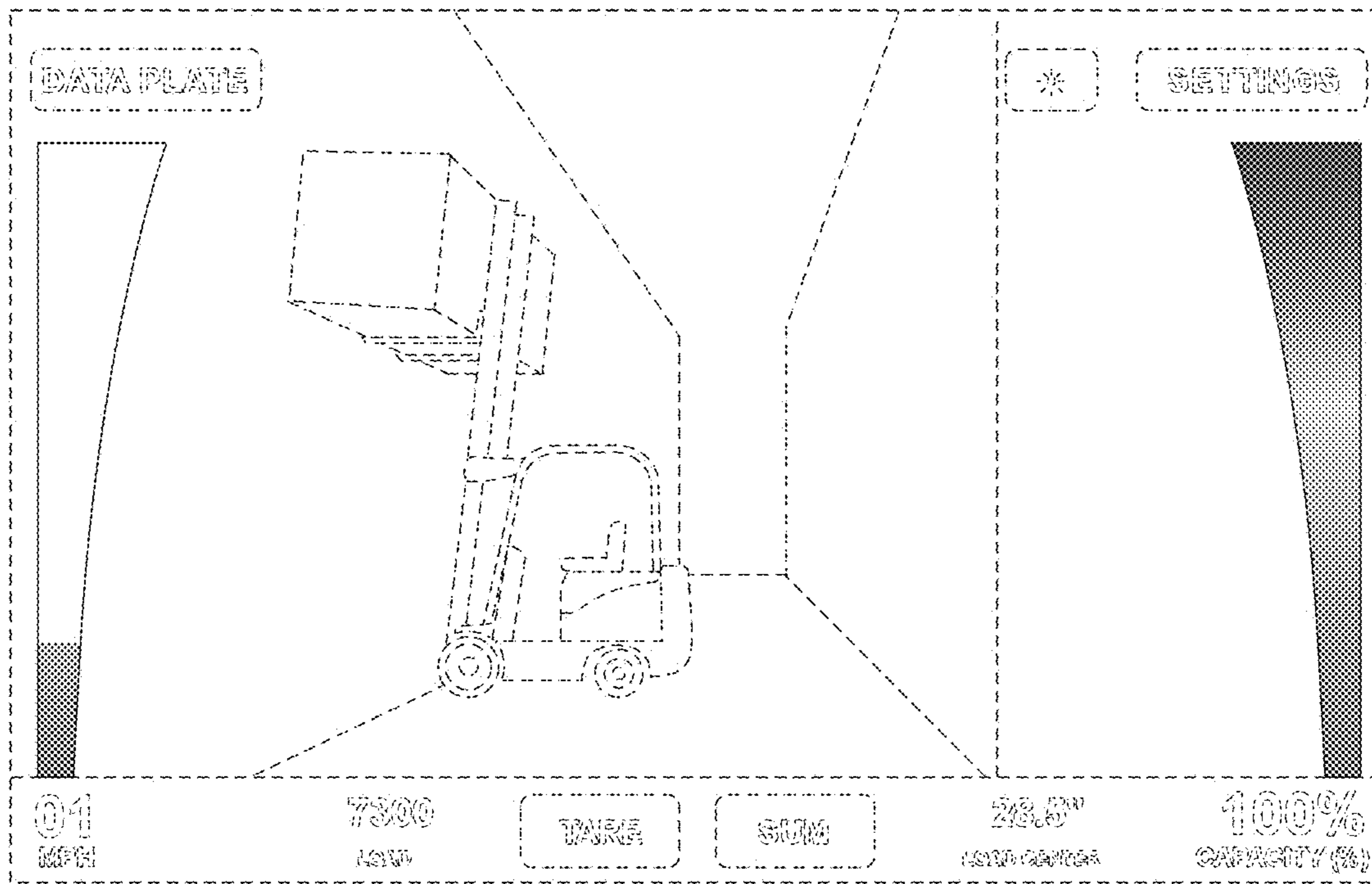

FIG. 26

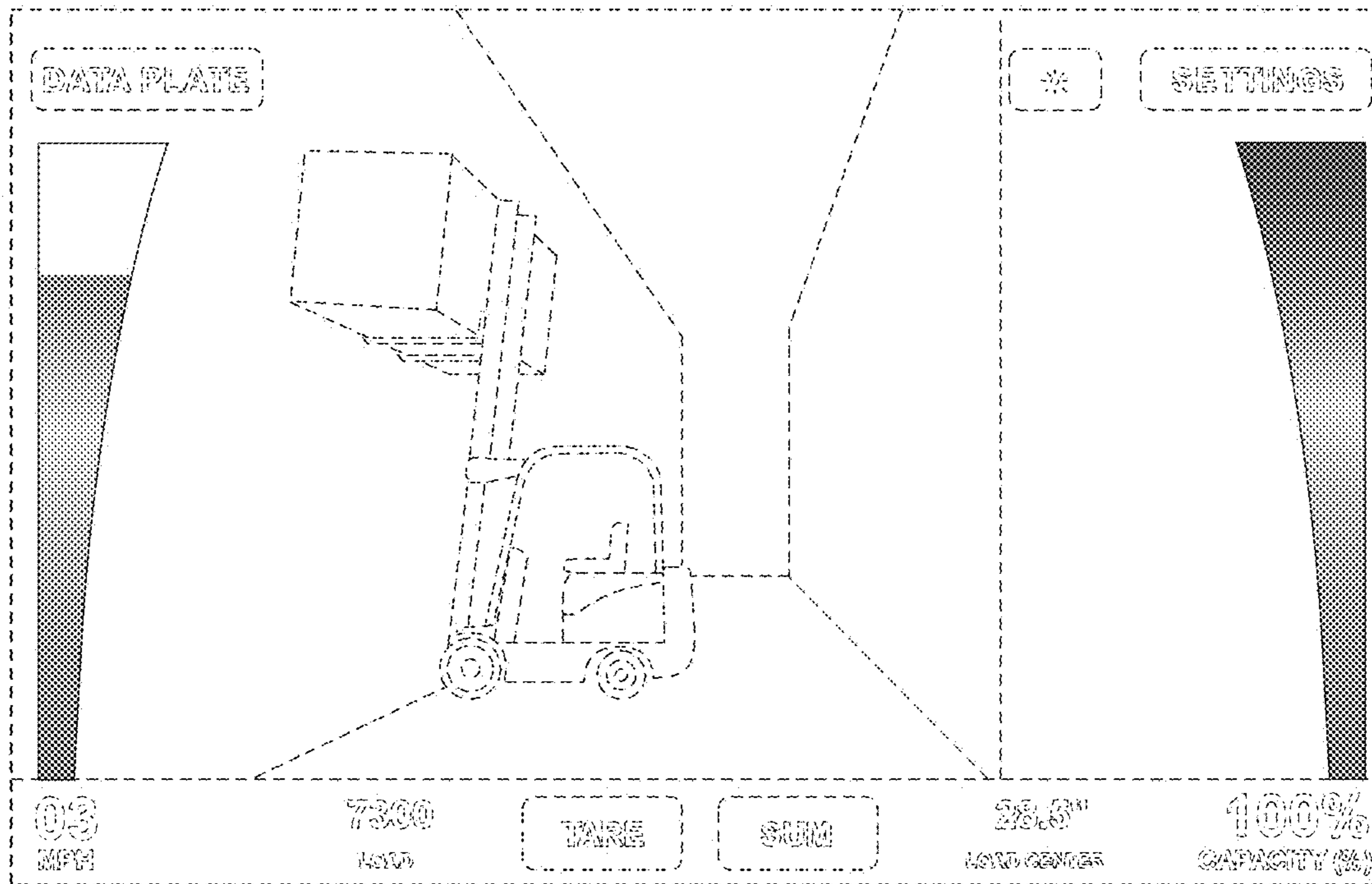

FIG. 27

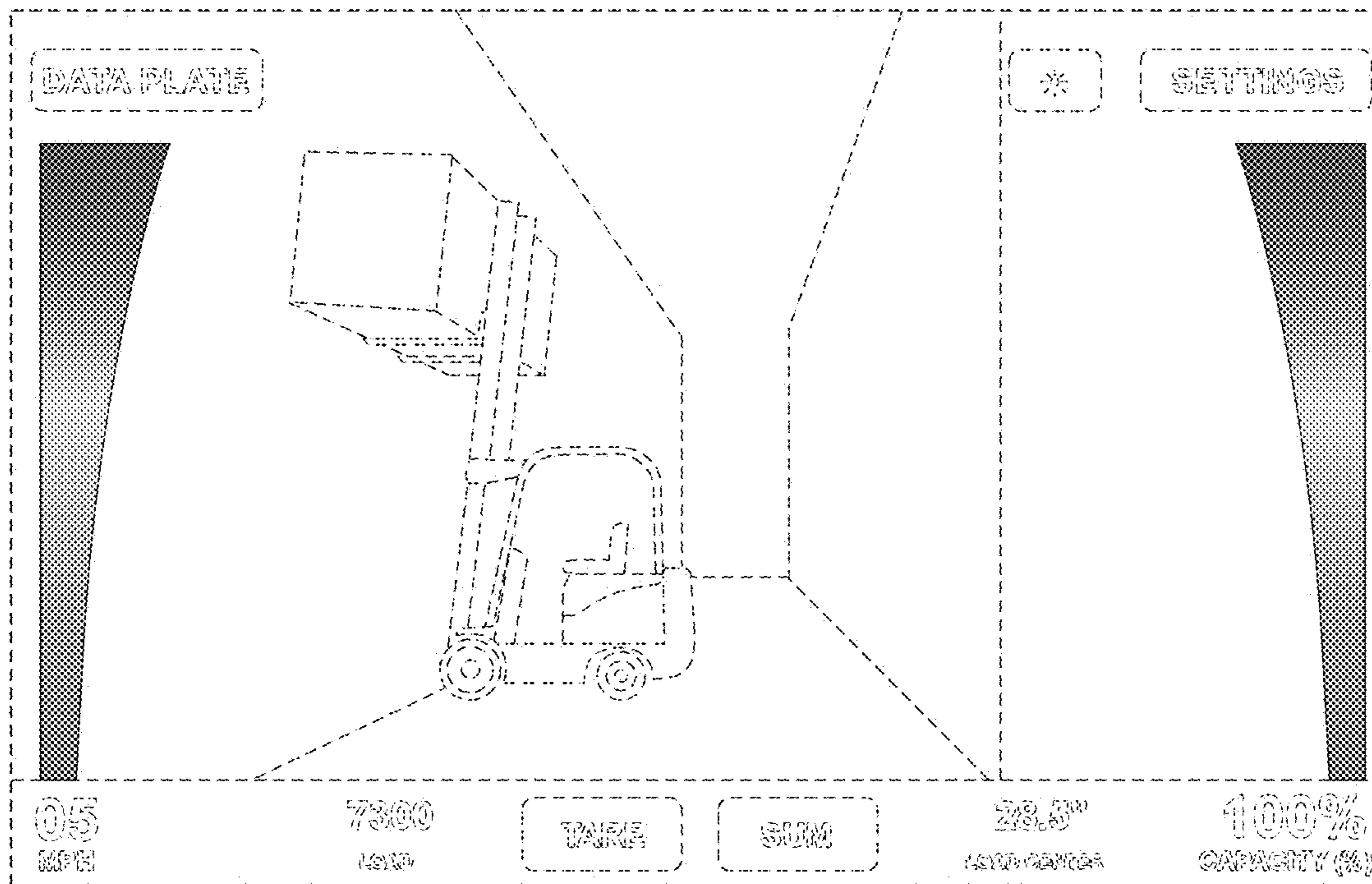

FIG. 28

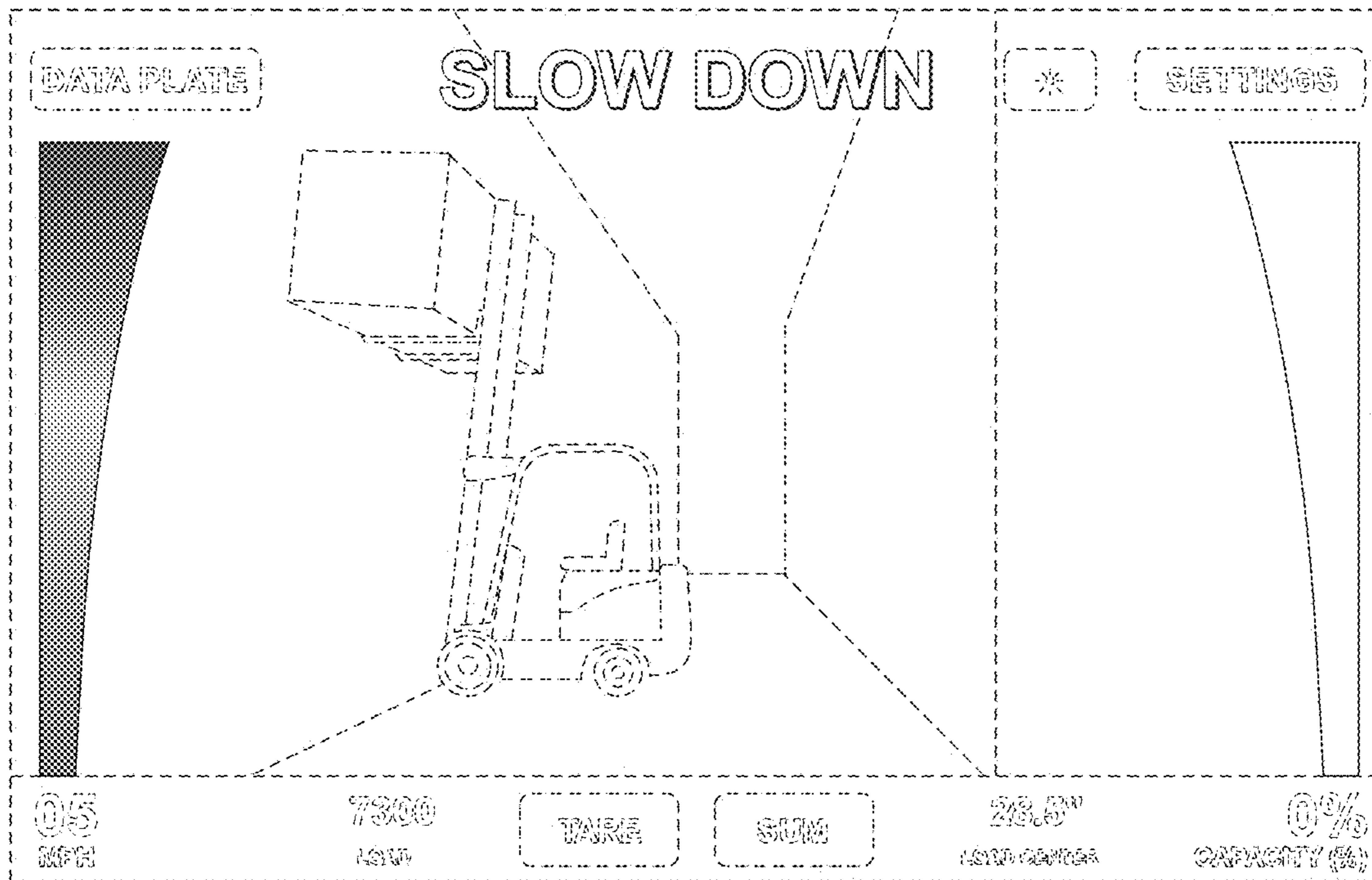

FIG. 29

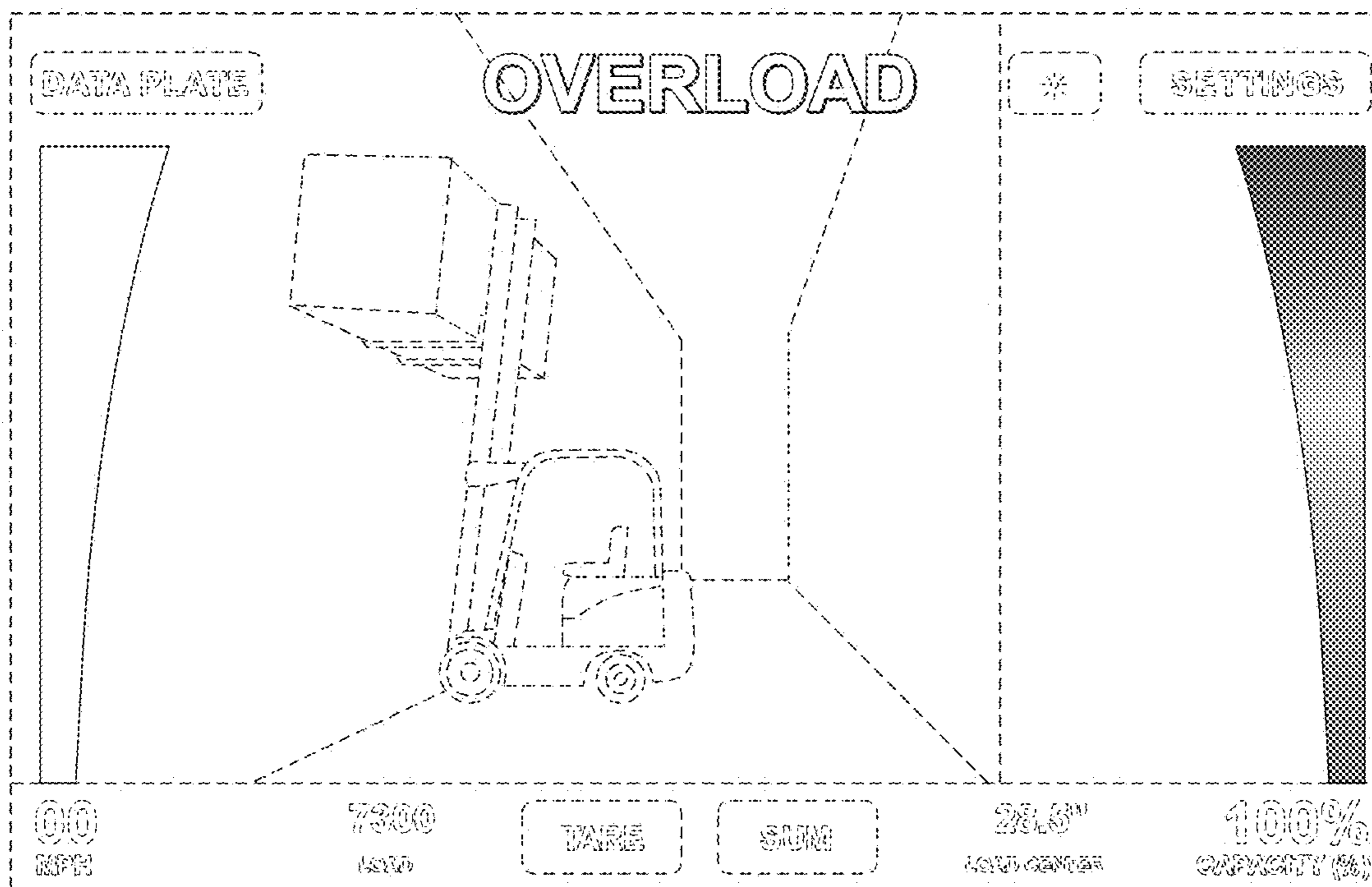

FIG. 30

