



US00D925447S

(12) **United States Design Patent** (10) **Patent No.:** **US D925,447 S**
Sun (45) **Date of Patent:** **** Jul. 20, 2021**

(54) **WIRELESS CHARGER**
(71) Applicant: **BEIJING XIAOMI MOBILE SOFTWARE CO., LTD.**, Beijing (CN)
(72) Inventor: **Changyu Sun**, Beijing (CN)
(73) Assignee: **BEIJING XIAOMI MOBILE SOFTWARE CO., LTD.**, Beijing (CN)
(**) Term: **15 Years**
(21) Appl. No.: **35/509,440**
(22) Filed: **Feb. 11, 2020**
(80) **Hague Agreement Data**
Int. Filing Date: **Feb. 11, 2020**
Int. Reg. No.: **DM/207984**
Int. Reg. Date: **Feb. 11, 2020**
Int. Reg. Pub. Date: **May 22, 2020**

(30) **Foreign Application Priority Data**
Aug. 23, 2019 (CN) 201930462757.6
(51) **LOC (13) Cl.** **13-02**
(52) **U.S. Cl.**
USPC **D13/108**
(58) **Field of Classification Search**
USPC D13/108, 107; D14/253, 434, 252
CPC H02J 7/0044
See application file for complete search history.

(56) **References Cited**
U.S. PATENT DOCUMENTS
D642,519 S * 8/2011 Woo D13/108
D664,528 S * 7/2012 Chen D14/253
D703,133 S * 4/2014 Ireland D13/108
D772,812 S * 11/2016 Choe D13/108

D791,072 S * 7/2017 Hoehn D13/107
D796,436 S * 9/2017 Rivera D13/108
D799,464 S * 10/2017 Zaihui D14/252
D812,564 S * 3/2018 Feng D13/108
D845,896 S * 4/2019 Hu D13/108
D859,308 S * 9/2019 Connell D13/108
D868,691 S * 12/2019 Sun D13/108
D880,418 S * 4/2020 Zhang D13/108
D884,621 S * 5/2020 Feng D13/108
D895,544 S * 9/2020 Zhao D13/108
D896,174 S * 9/2020 Li D13/108
D896,816 S * 9/2020 Qiu D14/434
D907,575 S * 1/2021 Xu D13/108
D911,941 S * 3/2021 Lee D13/108
D913,919 S * 3/2021 Wang D13/108
D915,276 S * 4/2021 Peng D13/108
D915,277 S * 4/2021 Peng D13/108
2009/0051319 A1 * 2/2009 Fang H02J 7/0044
320/115
2010/0315041 A1 * 12/2010 Tan H02J 7/0044
320/115
2015/0129722 A1 * 5/2015 Green H02J 7/0044
248/51

* cited by examiner

Primary Examiner — Rhea Shields

(74) Attorney, Agent, or Firm — Syncoda LLC; Feng Ma

(57) **CLAIM**

The ornamental design for a wireless charger, as shown and described.

DESCRIPTION

- 1. Wireless charger
- 1.1 : Front
- 1.2 : Back
- 1.3 : Left
- 1.4 : Right
- 1.5 : Top
- 1.6 : Bottom
- 1.7 : Perspective

1 Claim, 7 Drawing Sheets

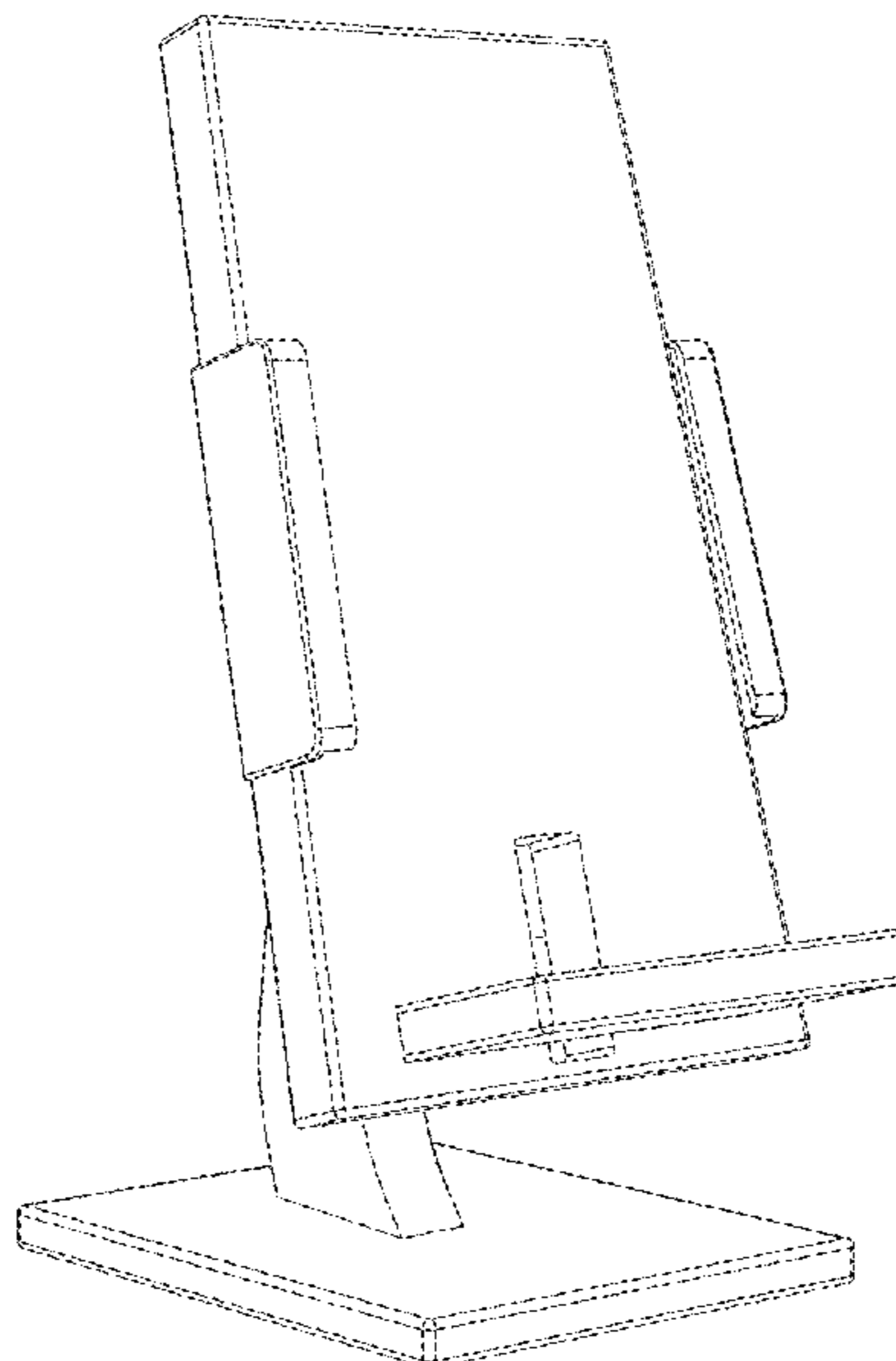

1.1

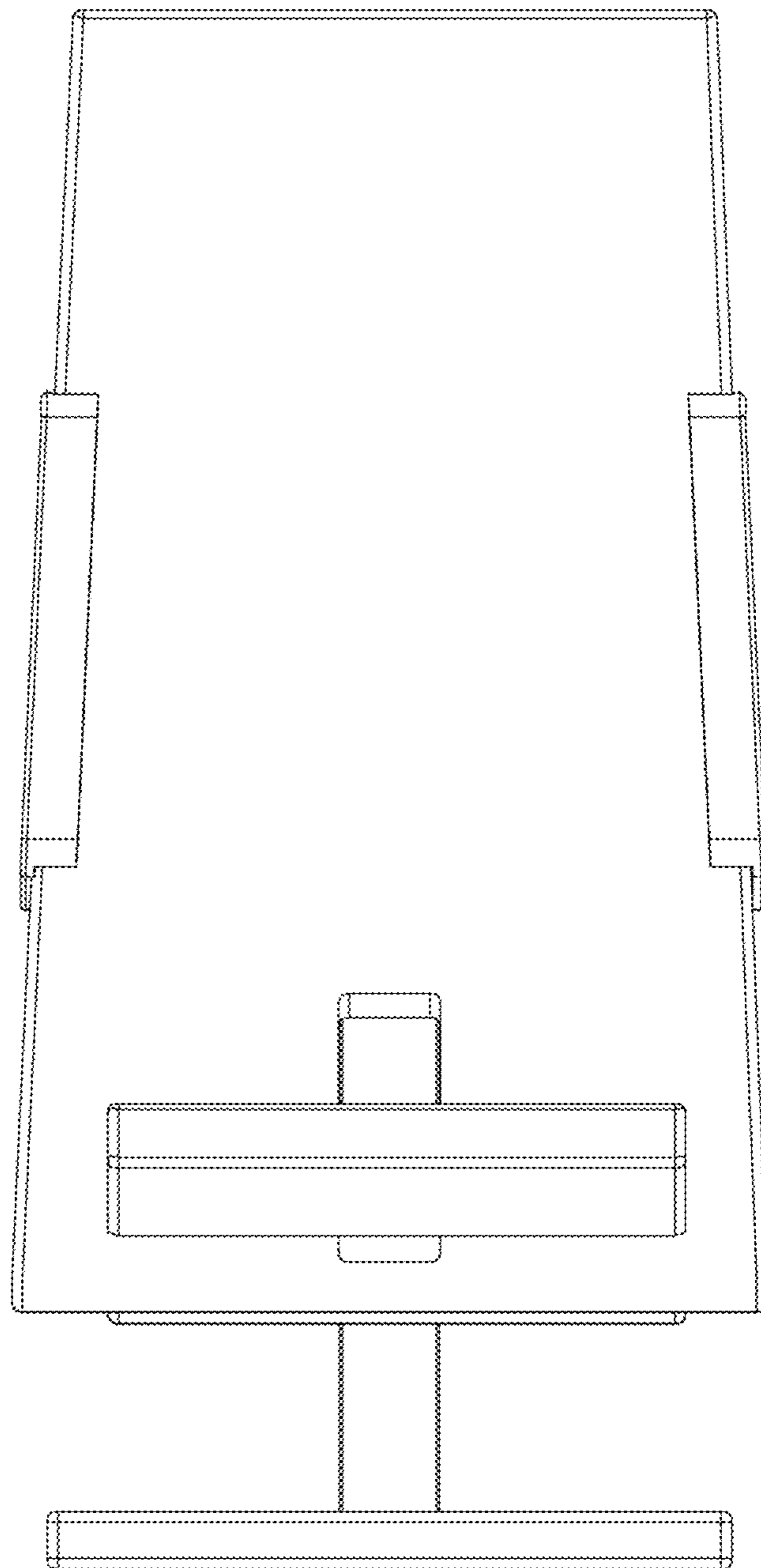

1.2

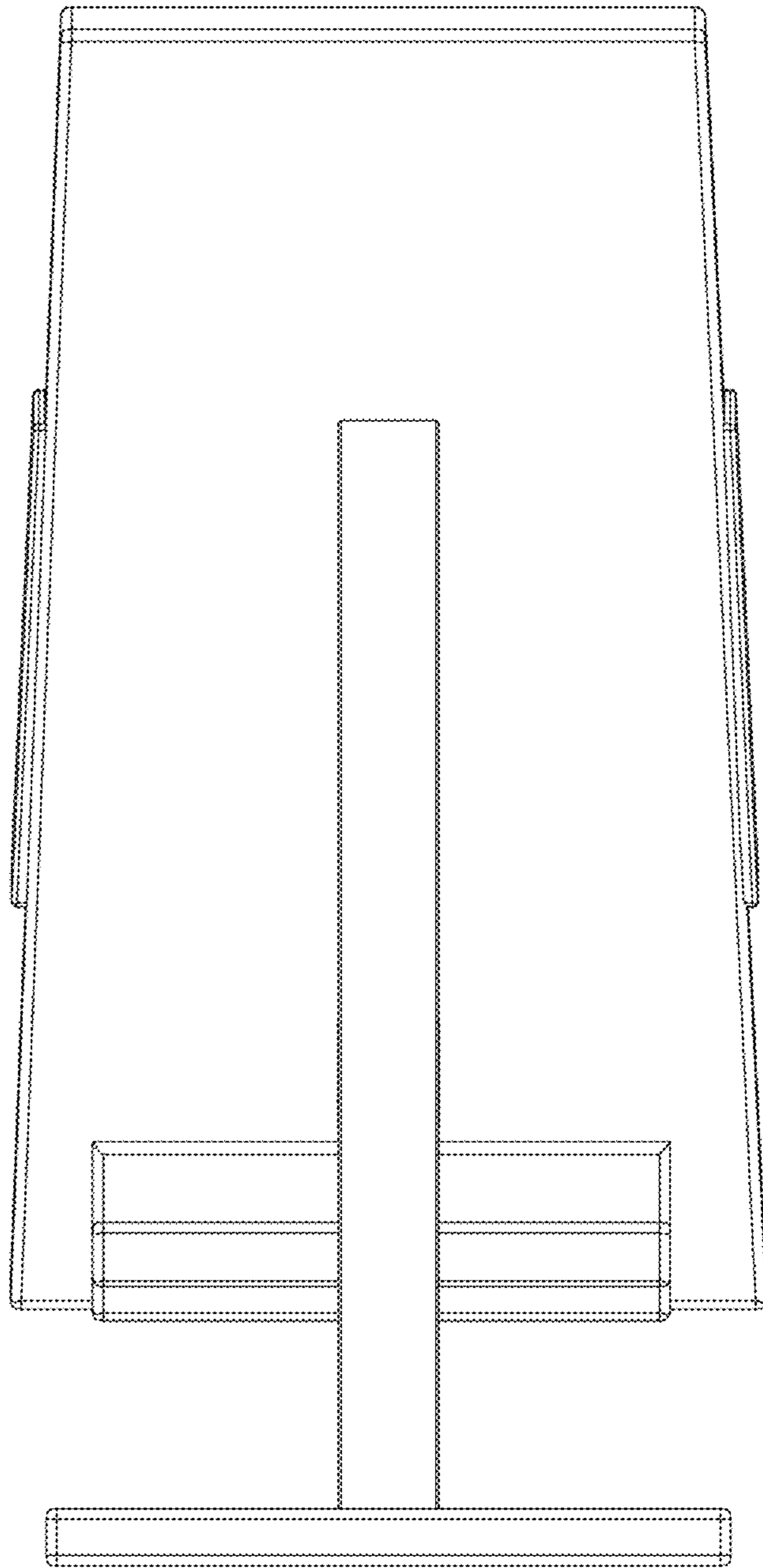

1.3

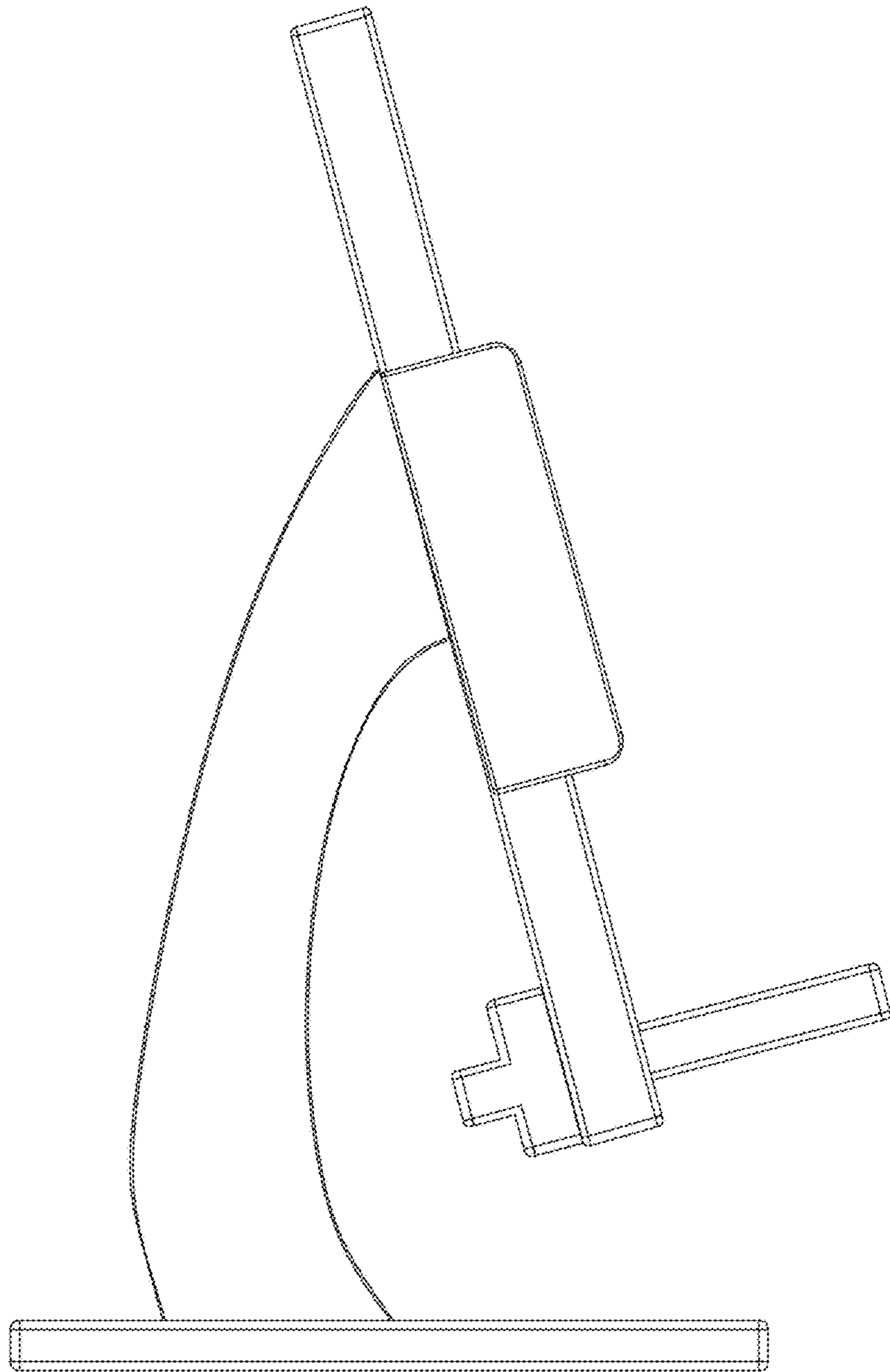

1.4

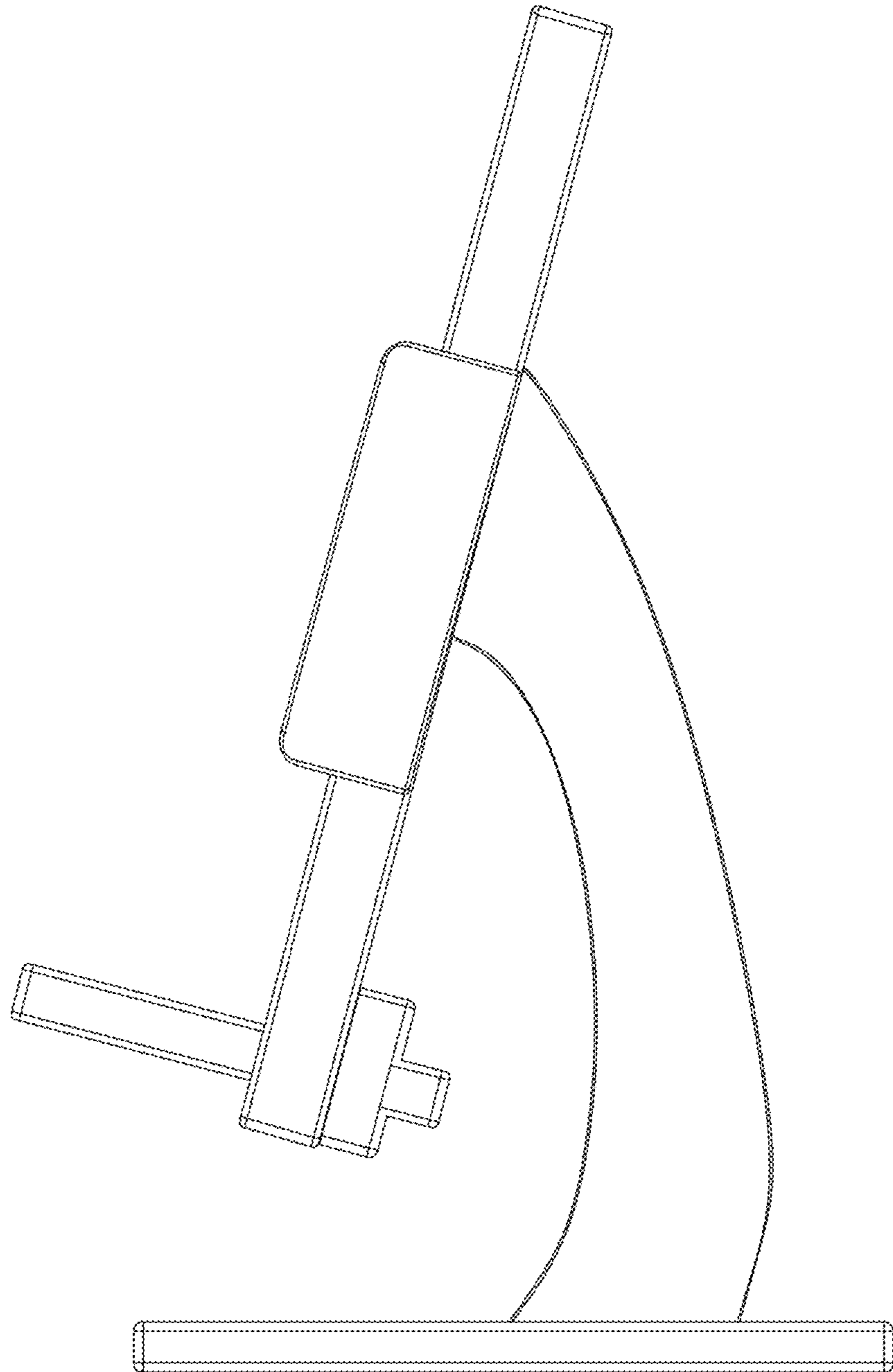

1.5

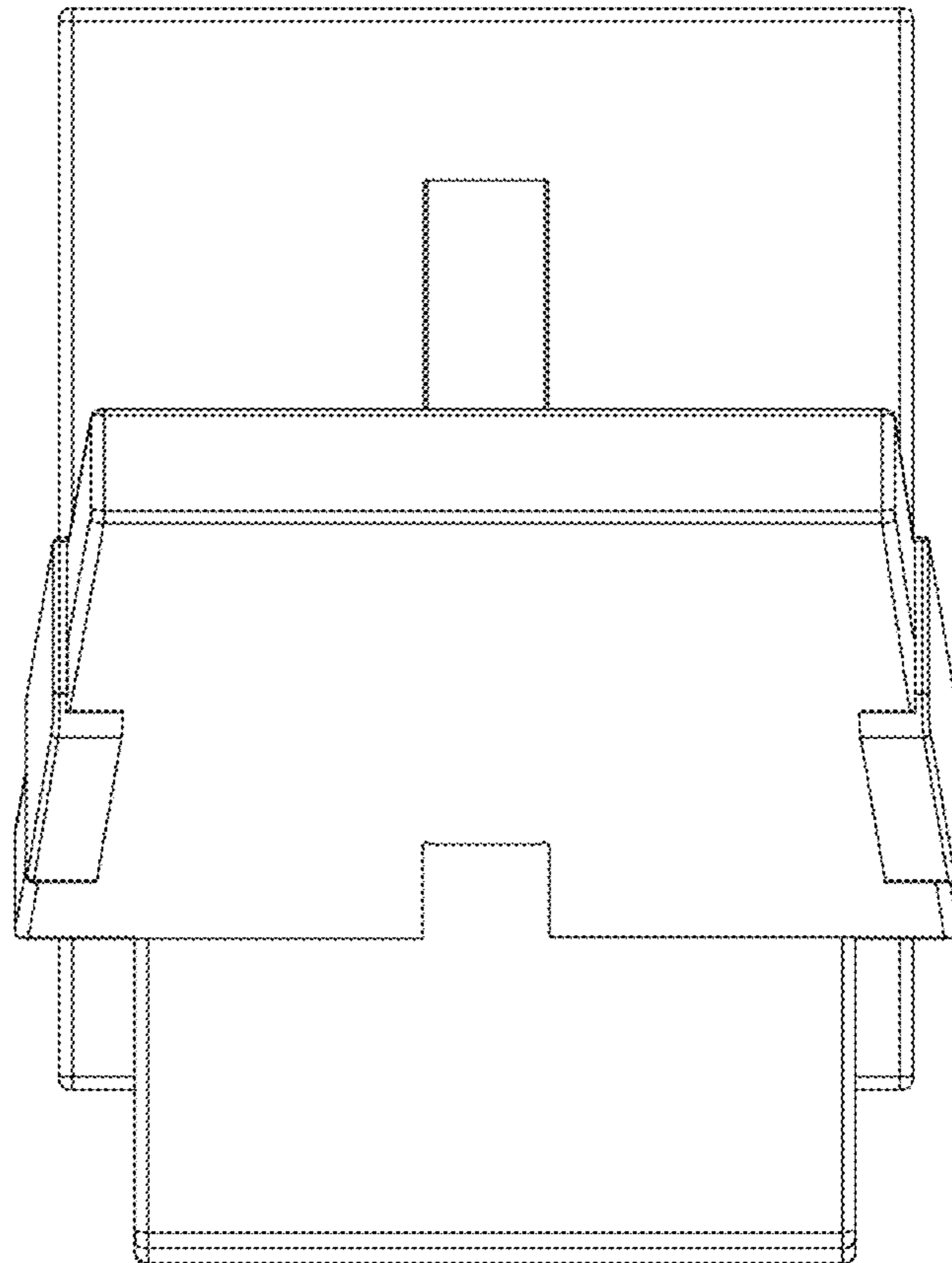

1.6

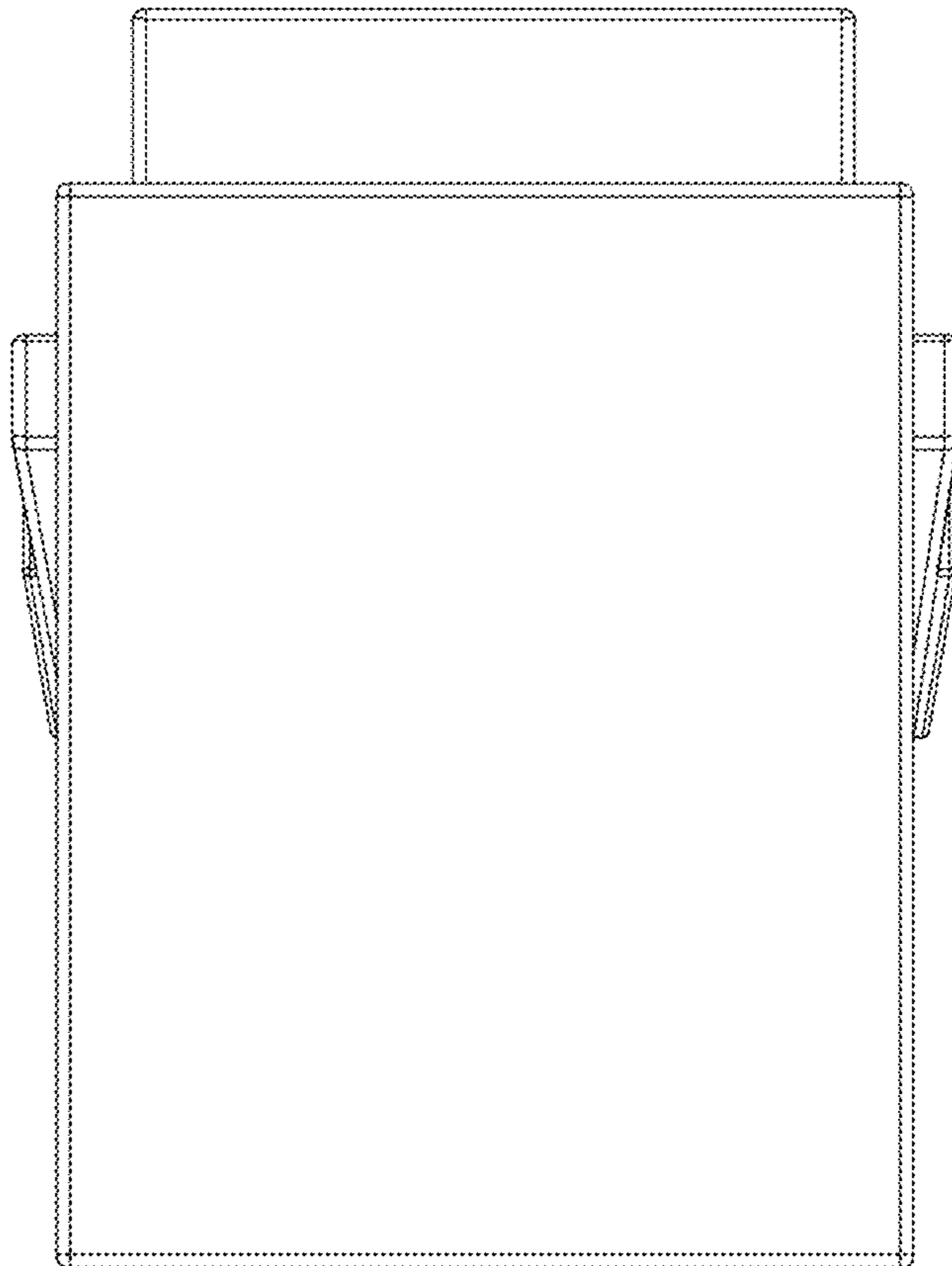

1.7

