



US00D925375S

(12) **United States Design Patent** (10) **Patent No.:** **US D925,375 S**
Malin (45) **Date of Patent:** **** Jul. 20, 2021**

(54) **BAG DESIGN**

(71) Applicant: **Mary Malin**, Los Angeles, CA (US)

(72) Inventor: **Mary Malin**, Los Angeles, CA (US)

(**) Term: **15 Years**

(21) Appl. No.: **29/726,183**

(22) Filed: **Feb. 29, 2020**

Related U.S. Application Data

(63) Continuation of application No. 14/723,179, filed on May 27, 2015, now abandoned.

(51) **LOC (13) Cl.** **09-05**

(52) **U.S. Cl.**
USPC **D9/703**

(58) **Field of Classification Search**
USPC D9/702-714, 719, 738-740, 517-518, D9/522, 416, 435, 444, 460, 455, 414, D9/499, 431-432; D7/560-562; 206/434, 426-427, 429-430, 485, 485.1, 206/499, 508, 431, 418-422, 588-594; 229/117.3, 185, 121, 122, 200, 207, 236, 229/87.01; 220/23.83; 150/100-118; 294/137, 152; 383/6, 10, 14, 20, 40, 33, 383/104-105, 117, 108, 120, 93, 121.1, 383/127; 428/34.3
CPC B65D 33/00; B65D 33/06; B65D 33/065; B65D 33/14; B65D 33/1683; B65D 33/12; B65D 31/00; B65D 31/04; B65D 31/10; A45C 3/04; A45C 3/10

See application file for complete search history.

(56) **References Cited**

U.S. PATENT DOCUMENTS

D494,853 S *	8/2004	Chan	D9/704
D576,500 S *	9/2008	Kim	D9/703
D578,409 S *	10/2008	Clark	D9/703
D796,341 S *	9/2017	Barlier	D9/703
D860,807 S *	9/2019	Sill	D9/704
D900,629 S *	11/2020	Milos	D9/703

* cited by examiner

Primary Examiner — Abraham Bahta

(74) *Attorney, Agent, or Firm* — Lewis Brisbois Bisgaard & Smith LLP

(57) **CLAIM**

The ornamental design for a bag design, as shown and described.

DESCRIPTION

FIG. 1 is a perspective view of a bag design; FIG. 2 is a front elevation view thereof; FIG. 3 is a side elevation view thereof; FIG. 4 top plan view thereof; FIG. 5 is a bottom plan view thereof; and, FIG. 6 is a perspective view showing the interior of the bag design.
The broken lines shown are included for the purpose of illustrating the unclaimed portions of the article and the article's environment and form no part of the claim.

1 Claim, 3 Drawing Sheets

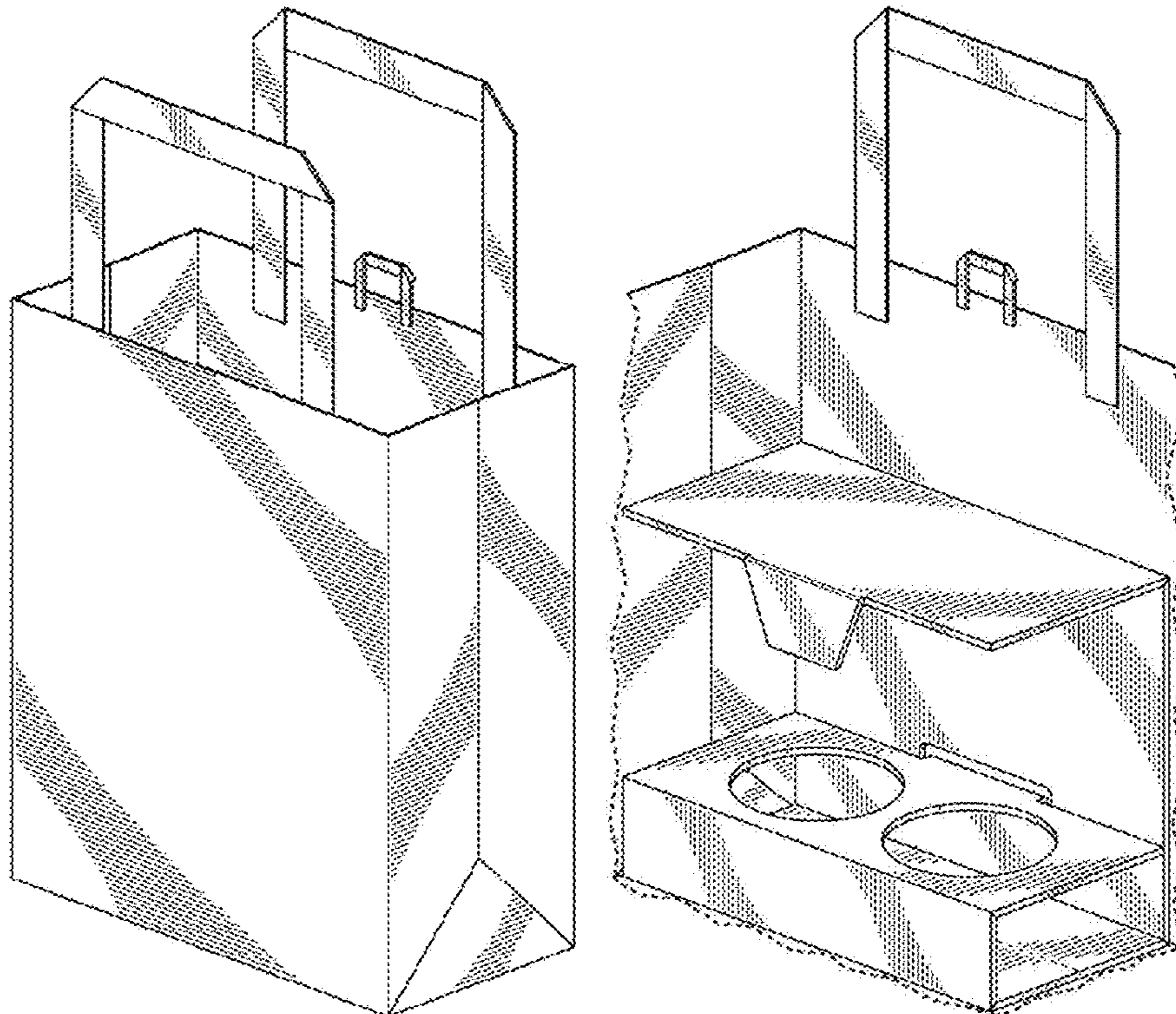

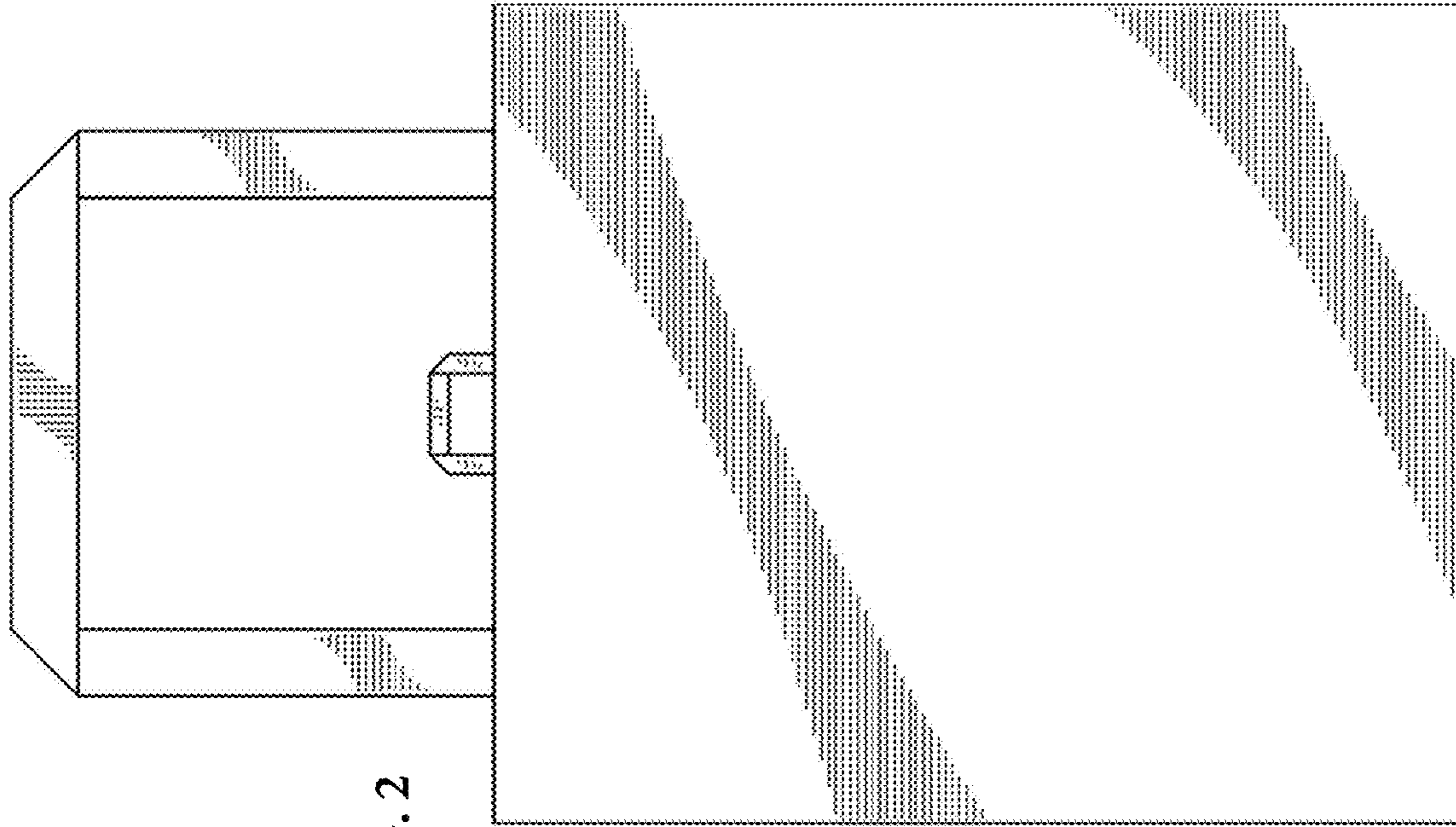

FIG. 2

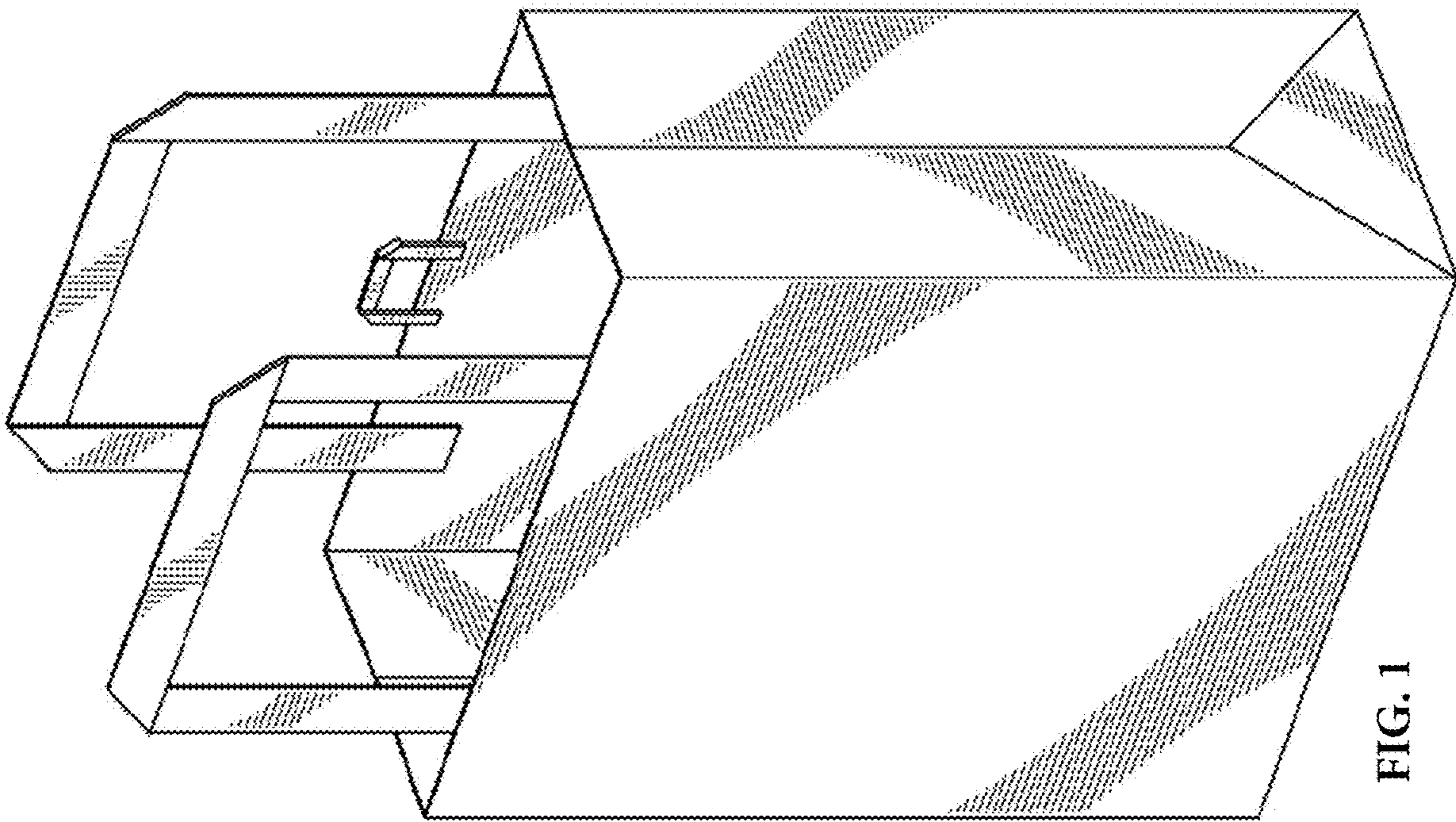

FIG. 1

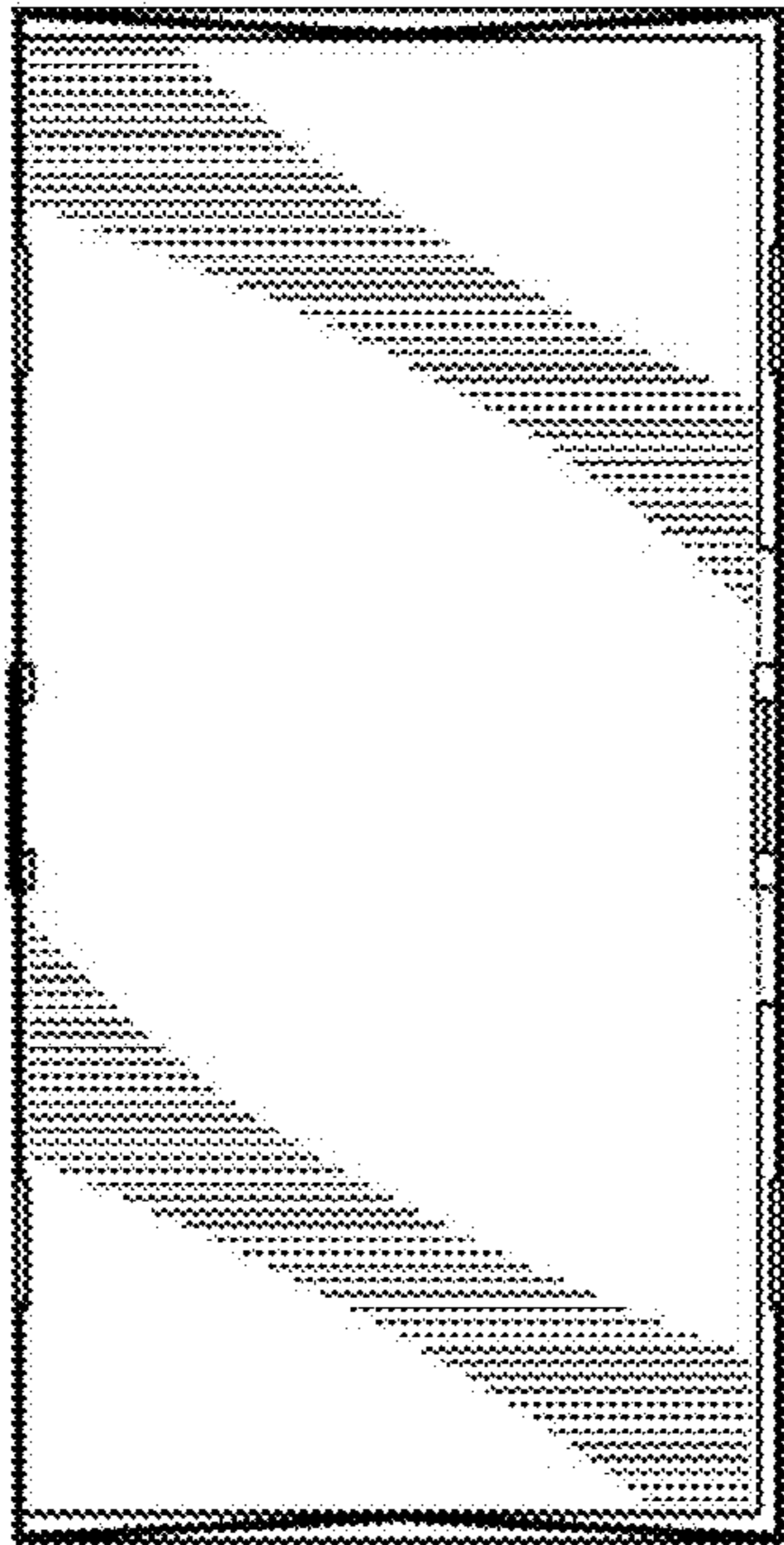

FIG. 4

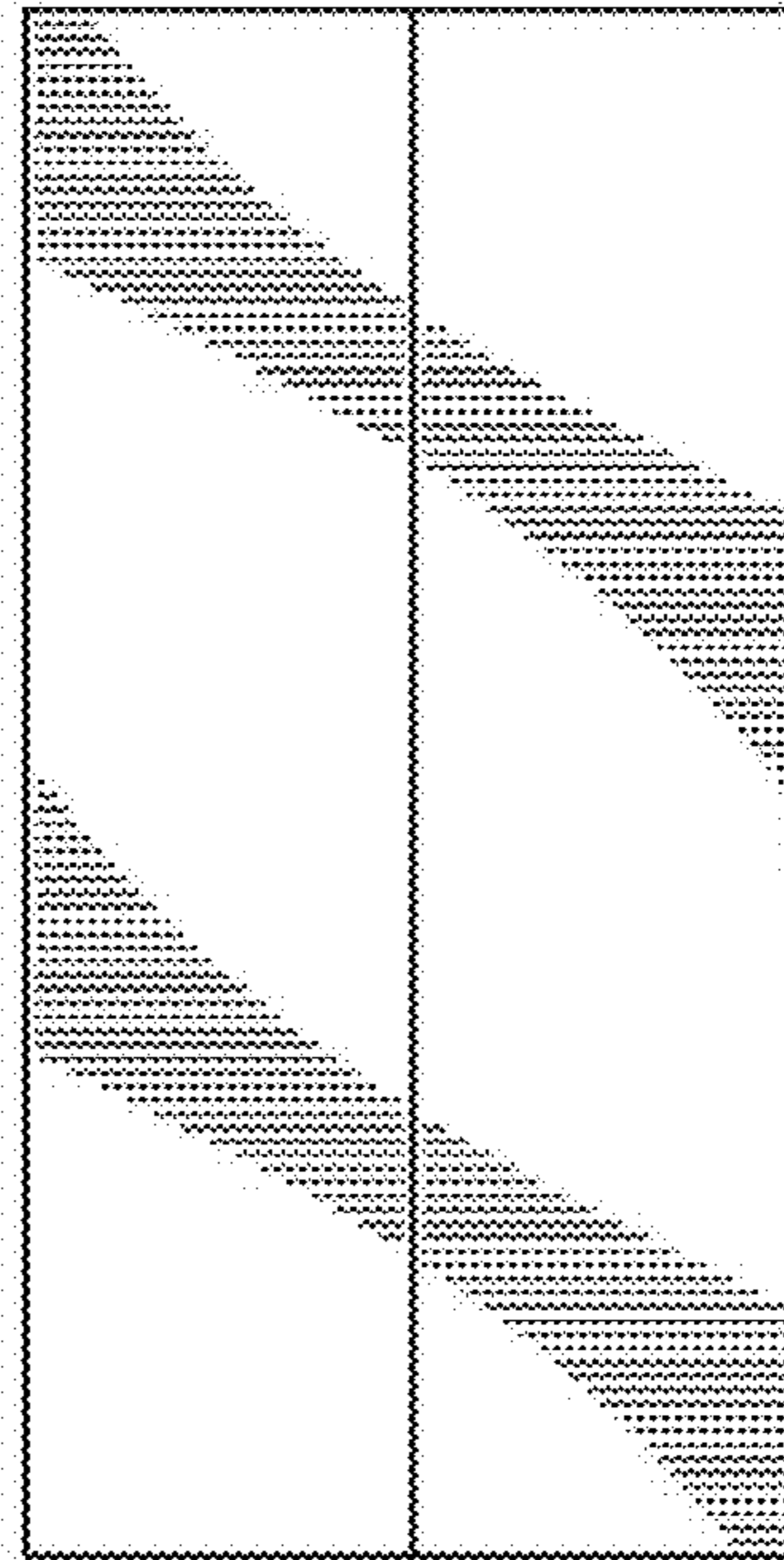

FIG. 5

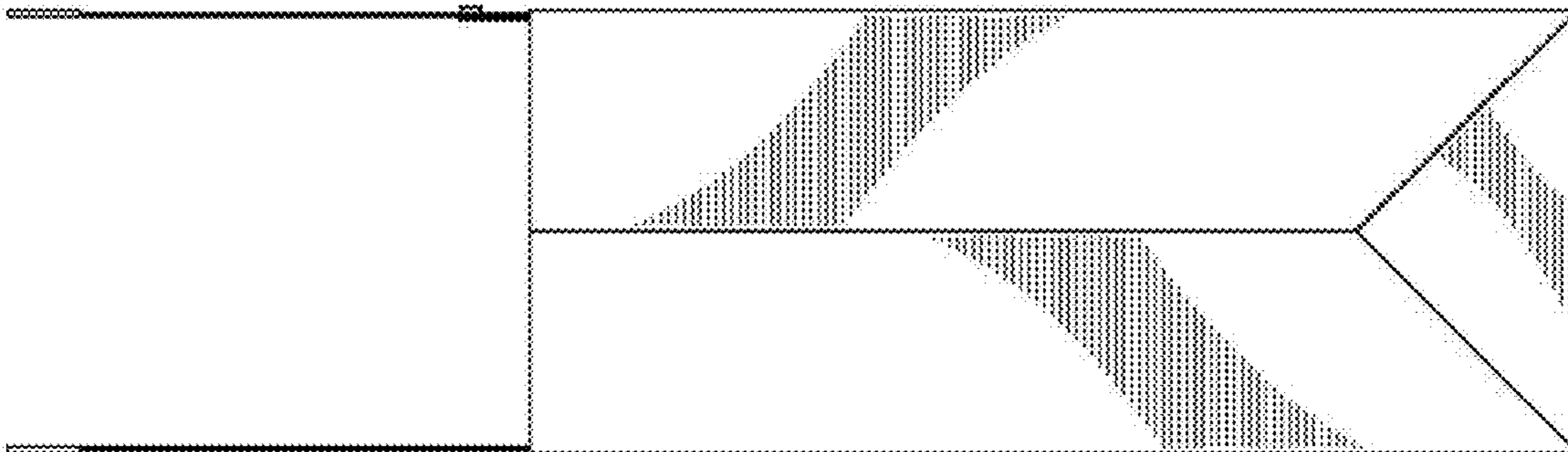

FIG. 3

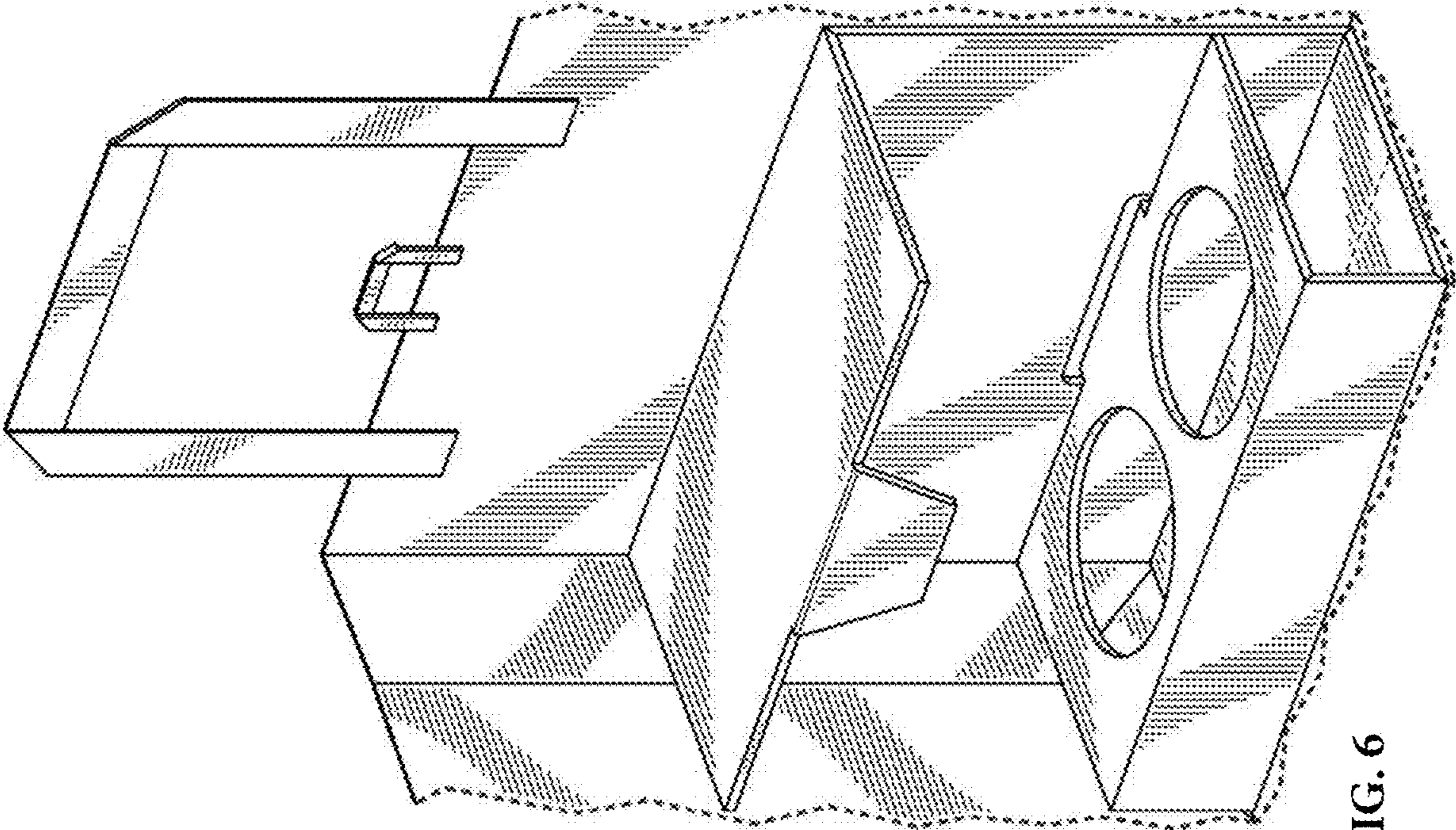

FIG. 6