



US00D925352S

(12) **United States Design Patent** (10) **Patent No.:** **US D925,352 S**
De Silva et al. (45) **Date of Patent:** **** Jul. 20, 2021**

(54) **PACKAGE**

(71) Applicants: **Anuradha Andy De Silva**, Ranchos Palos Verdes, CA (US); **Shehan James**, Los Angeles, CA (US); **Dinesh Weerasekera**, Fullerton, CA (US)

(72) Inventors: **Anuradha Andy De Silva**, Ranchos Palos Verdes, CA (US); **Shehan James**, Los Angeles, CA (US); **Dinesh Weerasekera**, Fullerton, CA (US)

(**) Term: **15 Years**

(21) Appl. No.: **29/725,821**

(22) Filed: **Feb. 27, 2020**

(51) **LOC (13) Cl.** **09-03**

(52) **U.S. Cl.**

USPC **D9/425; D9/431**

(58) **Field of Classification Search**

USPC D9/414-420, 421-433, 434, 442, 445, D9/456, 499, 542, 563, 600, 614-624, D9/661, 635, 643, 699, 707, 708, 711, D9/754, 759, 732, 737, 756; D3/273, D3/276, 304, 309-313, 203.1, 203.2; D7/601, 602, 709, 543, 545, 629; D24/224

CPC B65D 5/00; B65D 5/001; B65D 5/0027; B65D 5/0254; B65D 5/18; B65D 5/38; B65D 5/40; B65D 5/2033; B65D 5/48024; B65D 5/6605; B65D 1/22; B65D 1/24; B65D 1/34; B65D 73/0035; B65D 73/0085; B65D 75/58; B65D 2543/00194; B65D 1/36; B65D 73/0078; B65D 2543/00805; B65D 73/0042; B65D 75/225; B65D 21/0204; B65D 43/065; B65D 53/02; B65D 53/00; B65D 43/0208; B65D 43/021; B65D 81/2038; B65D 21/022; B65B 5/06

See application file for complete search history.

(56) **References Cited**

U.S. PATENT DOCUMENTS

D215,413	S	*	9/1969	Donovan	D9/425
D232,904	S	*	9/1974	Gregor	D7/391
D284,944	S	*	8/1986	Carlson	D9/425
D285,906	S	*	9/1986	Tyler	D9/425
D363,663	S	*	10/1995	Plater	D9/425
D411,741	S	*	6/1999	Wilson	D9/425
D503,534	S	*	4/2005	Dong	D3/276
D555,983	S	*	11/2007	Tucker	D7/542
D568,693	S	*	5/2008	Furlong	D7/629

(Continued)

FOREIGN PATENT DOCUMENTS

EM 008111033-0001 * 8/2020

OTHER PUBLICATIONS

TUPPERWARE Lunch Box 4 Containers Lunch Box(300 ml). Online, published date unknown. Retrieved on May 13, 2021 from URL: <https://www.paisawapas.com/p-tupperware-lunch-box-4-containers-lunch-box300-ml-456214>.*

Primary Examiner — Susan Bennett Hattan

Assistant Examiner — Omeed Agilee

(74) *Attorney, Agent, or Firm* — Eric Karich; Karich & Associates

(57) **CLAIM**

The ornamental design for a package, as shown and described.

DESCRIPTION

FIG. 1 is an exploded perspective view of a package showing our new design;
FIG. 2 is a perspective view of the package in a closed configuration;
FIG. 3 is a front elevational view thereof;
FIG. 4 is a rear elevational view thereof;
FIG. 5 is a left side elevational view thereof;
FIG. 6 is a right side elevational view thereof;
FIG. 7 is a top plan view thereof; and,

(Continued)

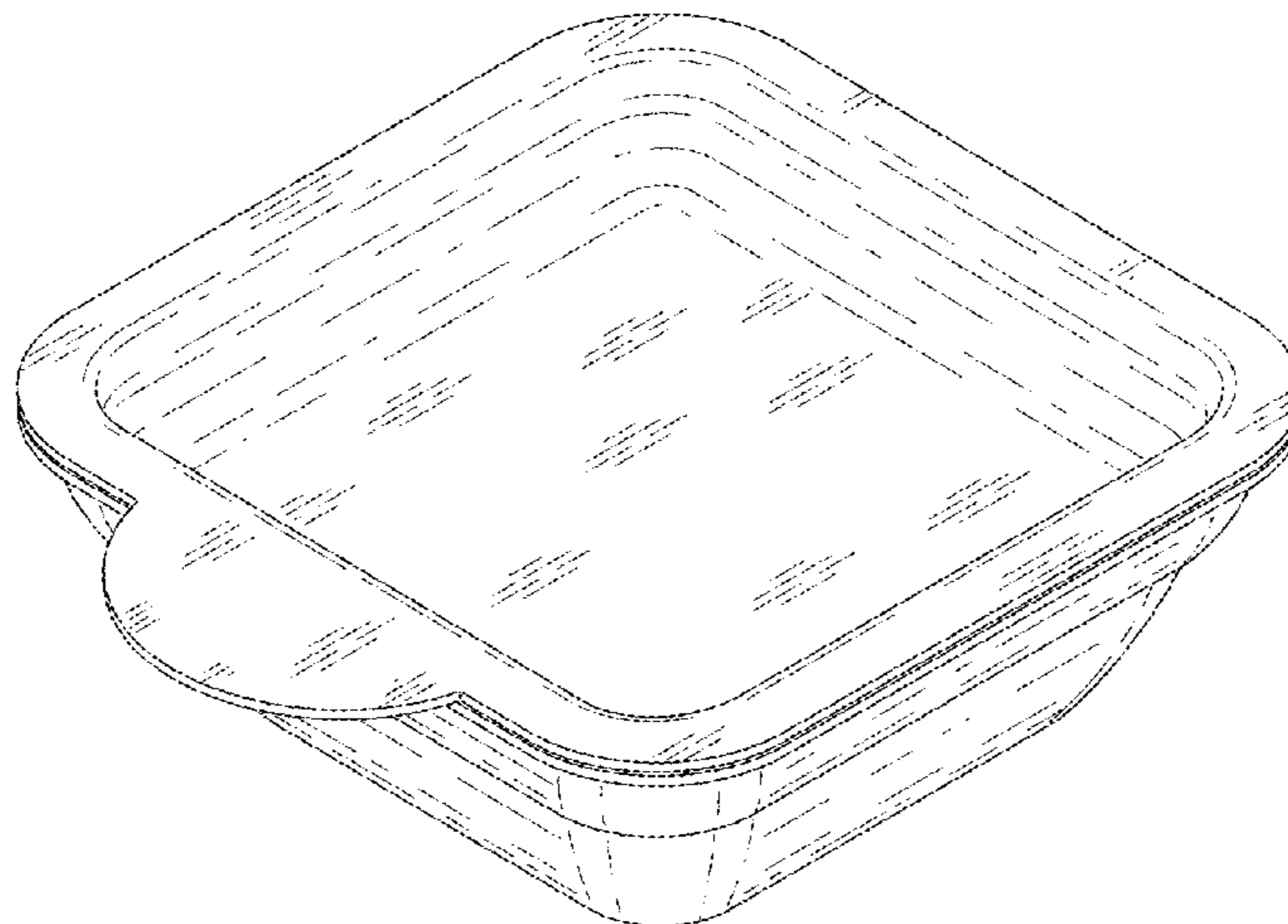

FIG. 8 is a bottom plan view thereof.

1 Claim, 3 Drawing Sheets

(56)

References Cited

U.S. PATENT DOCUMENTS

D652,672	S *	1/2012	Easton	D7/391
D700,483	S *	3/2014	Yessin	D7/629
D702,509	S *	4/2014	Segal	D7/629
D703,493	S *	4/2014	de Ste. Croix	D7/629
D722,832	S *	2/2015	Ra	D7/602
D722,834	S *	2/2015	Beckman	D7/629
D723,339	S *	3/2015	Maxwell	D7/629
D736,569	S *	8/2015	Bronwasser	D7/629
D758,805	S *	6/2016	Myoung	D7/629
D829,545	S *	10/2018	Thurin	D9/425
D849,405	S *	5/2019	Chen	D3/302
2002/0148840	A1 *	10/2002	Torniainen	B65D 21/0233 220/657
2016/0023815	A1 *	1/2016	Siskindovich	B65D 1/34 220/270
2018/0327148	A1 *	11/2018	Trahan	B65D 43/022
2020/0331674	A1 *	10/2020	Murphy	B65D 43/162

* cited by examiner

Fig. 1

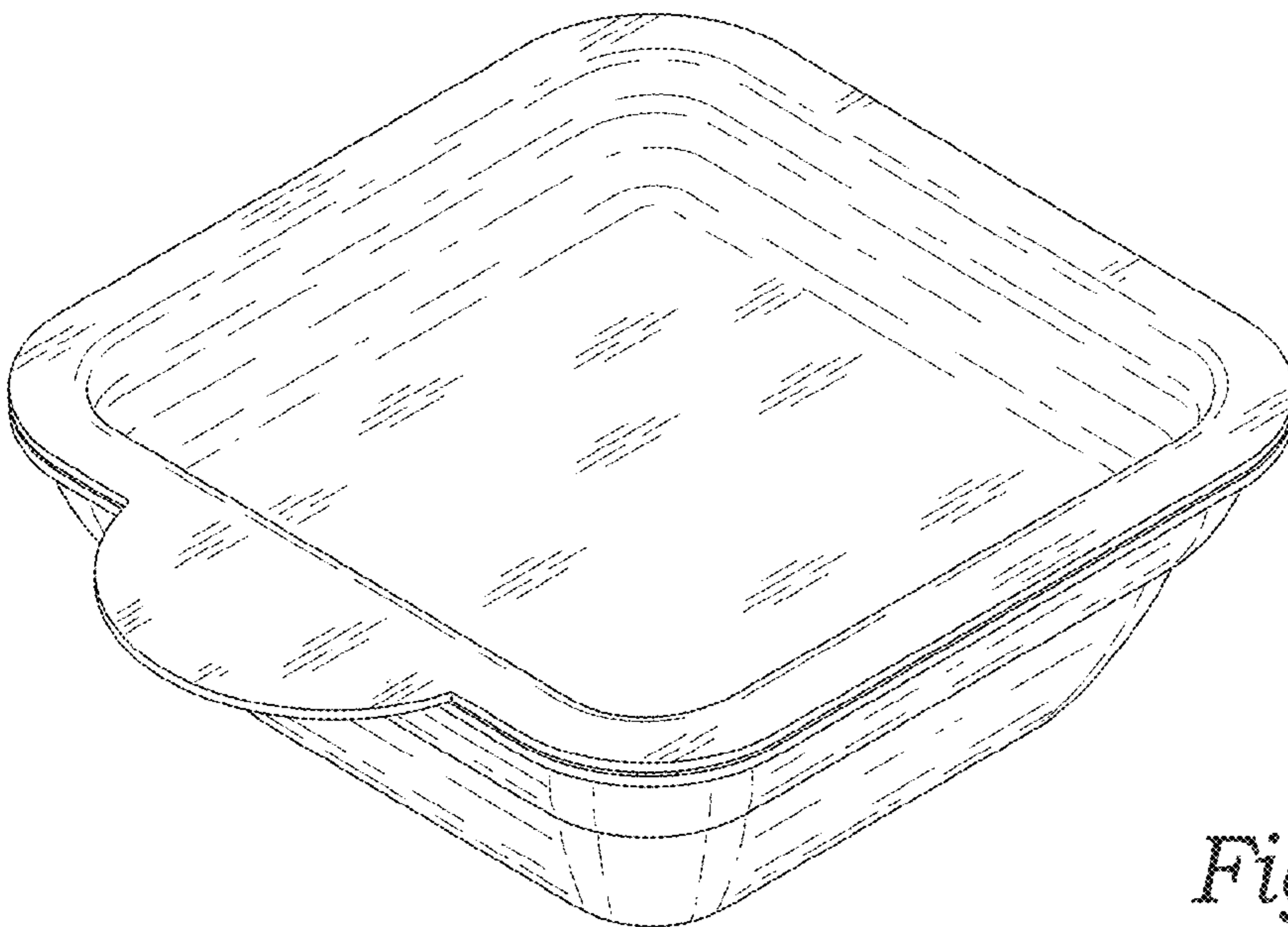
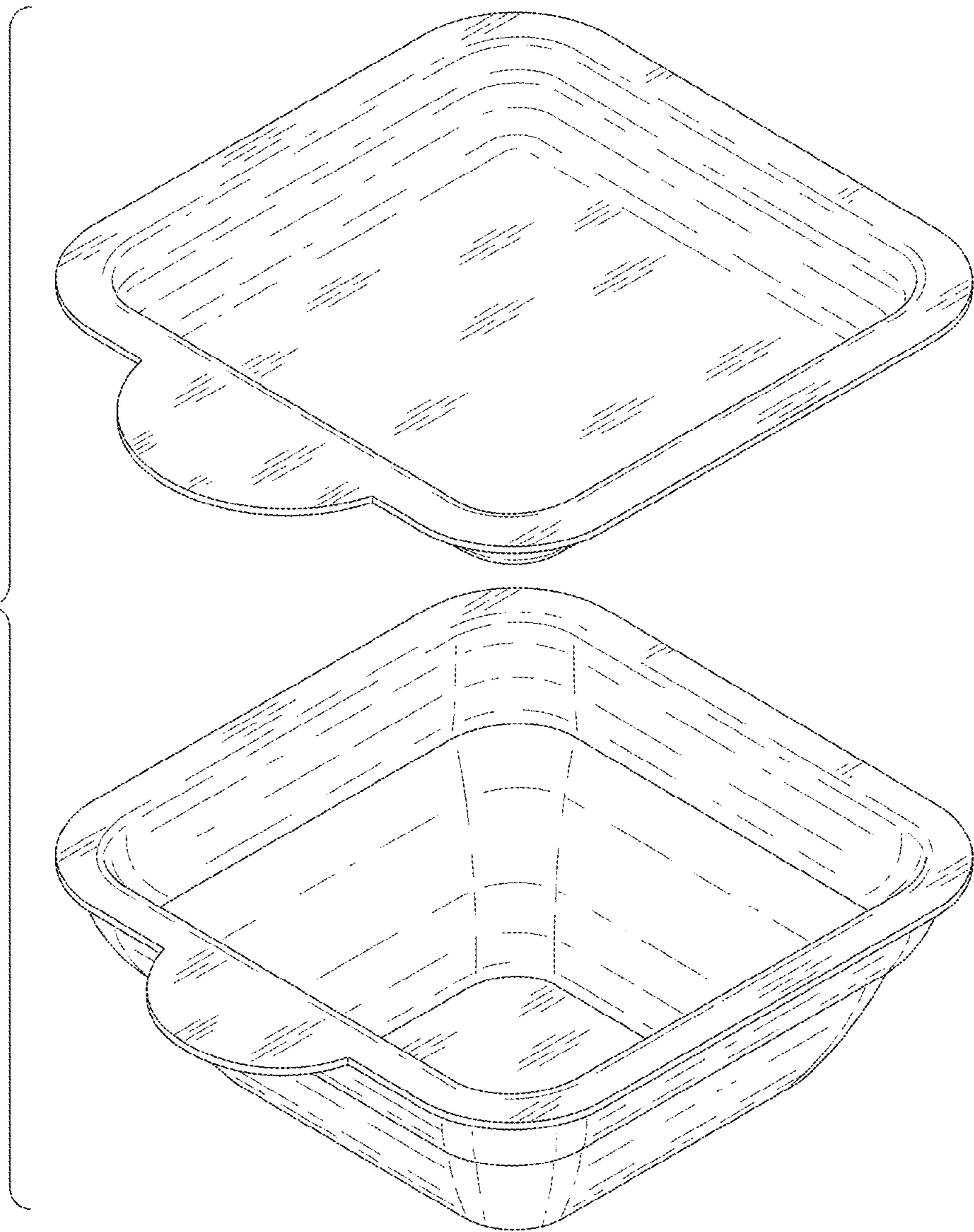

Fig. 2

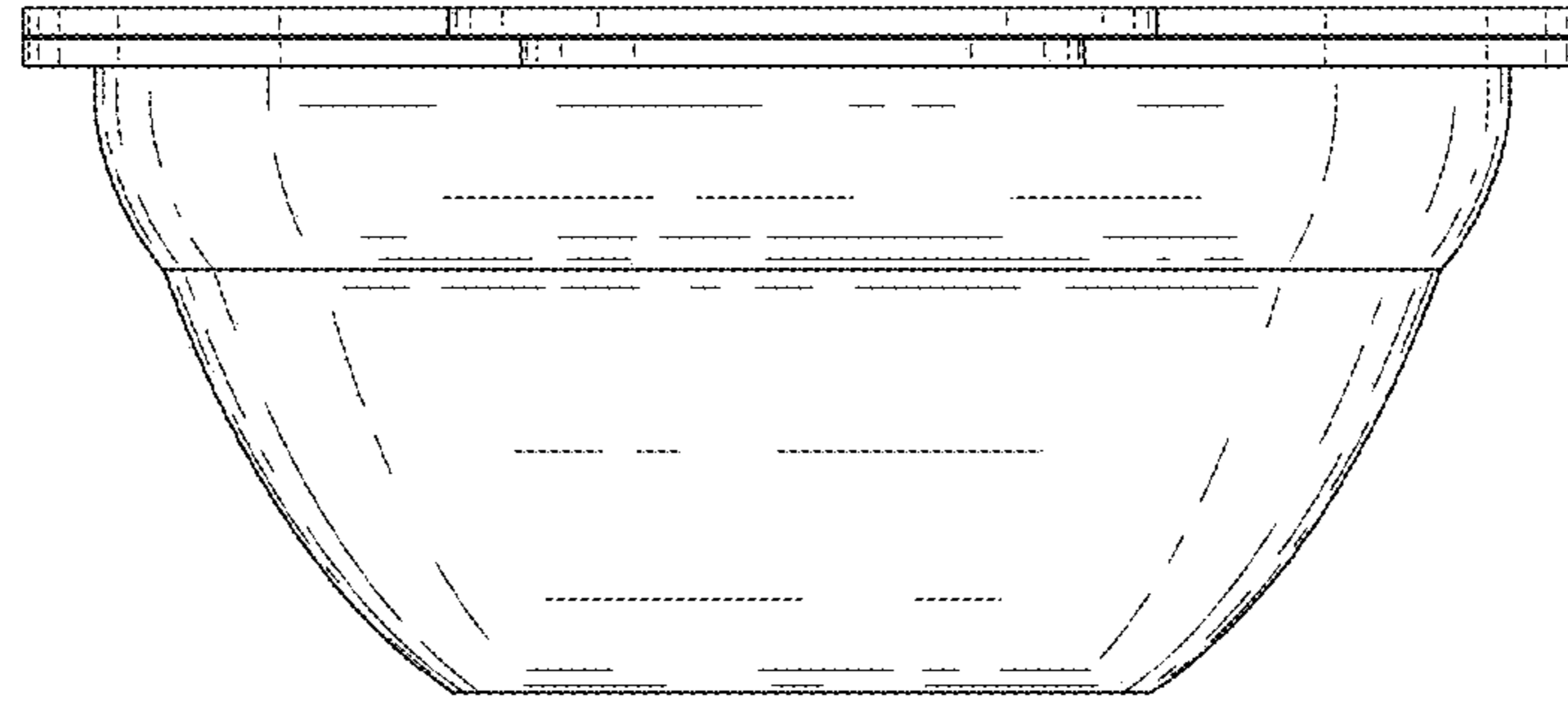

Fig. 3

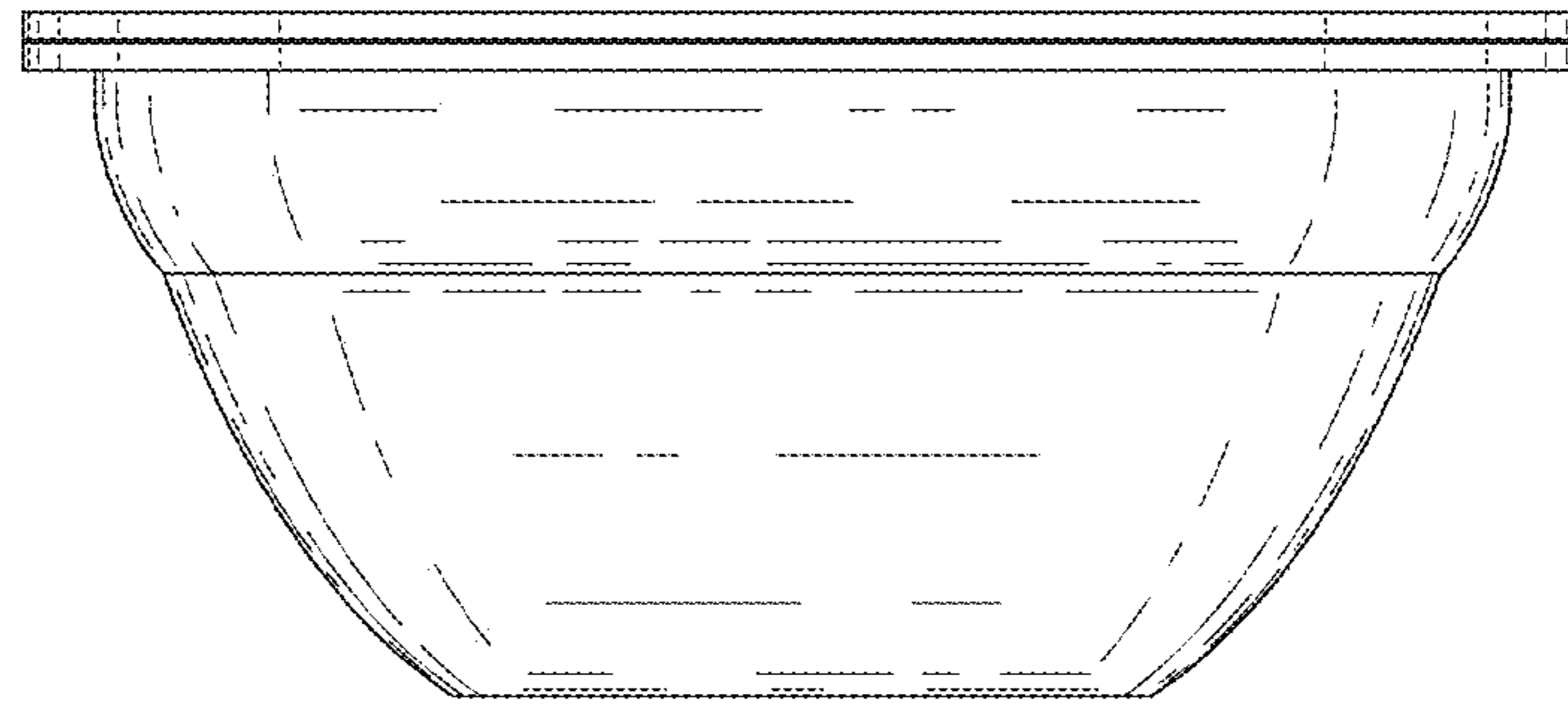

Fig. 4

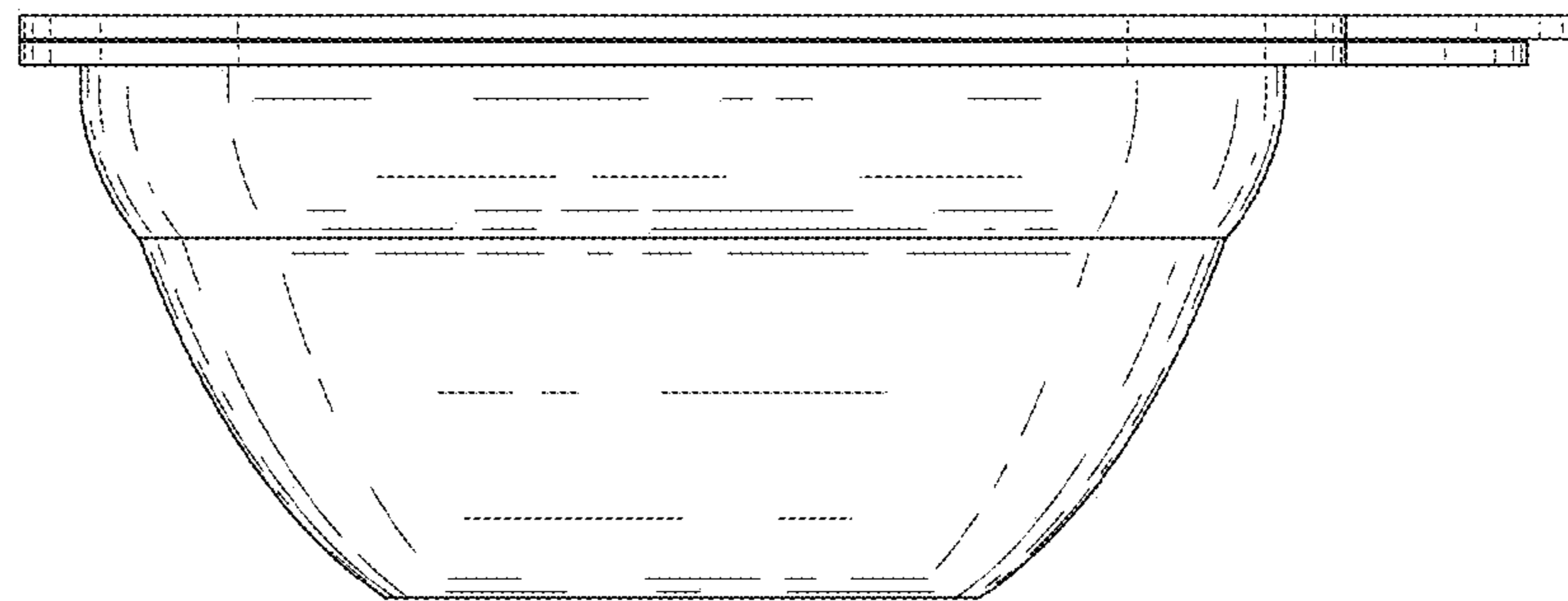

Fig. 5

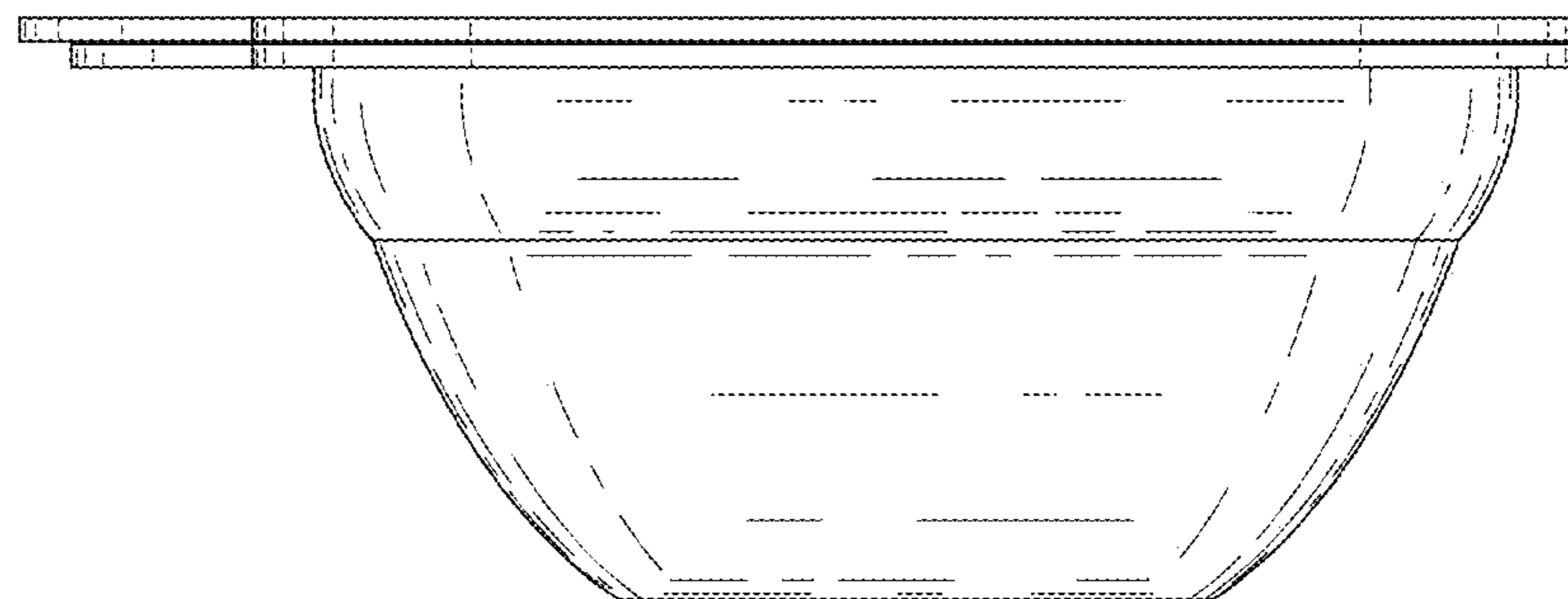

Fig. 6

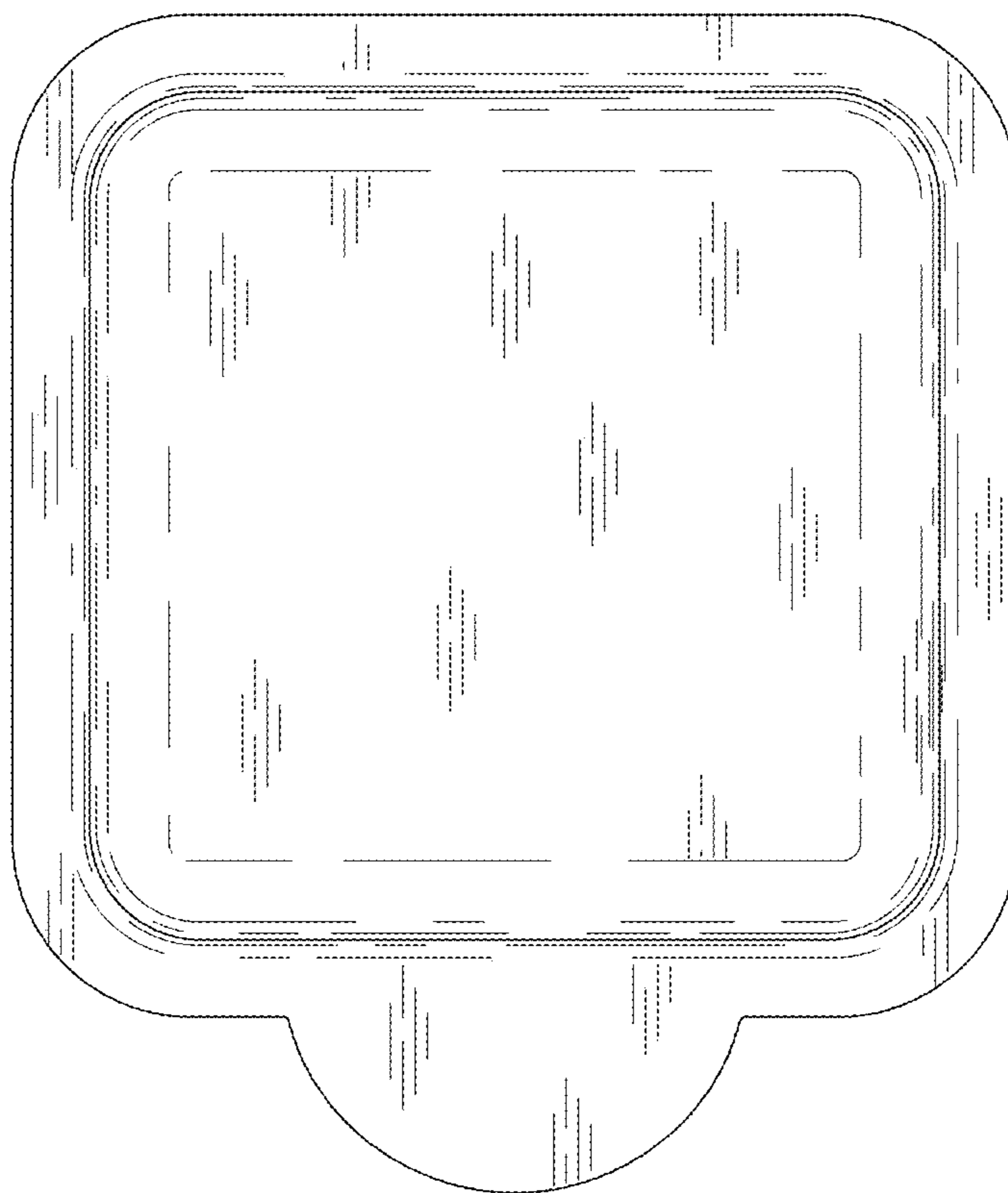

Fig. 7

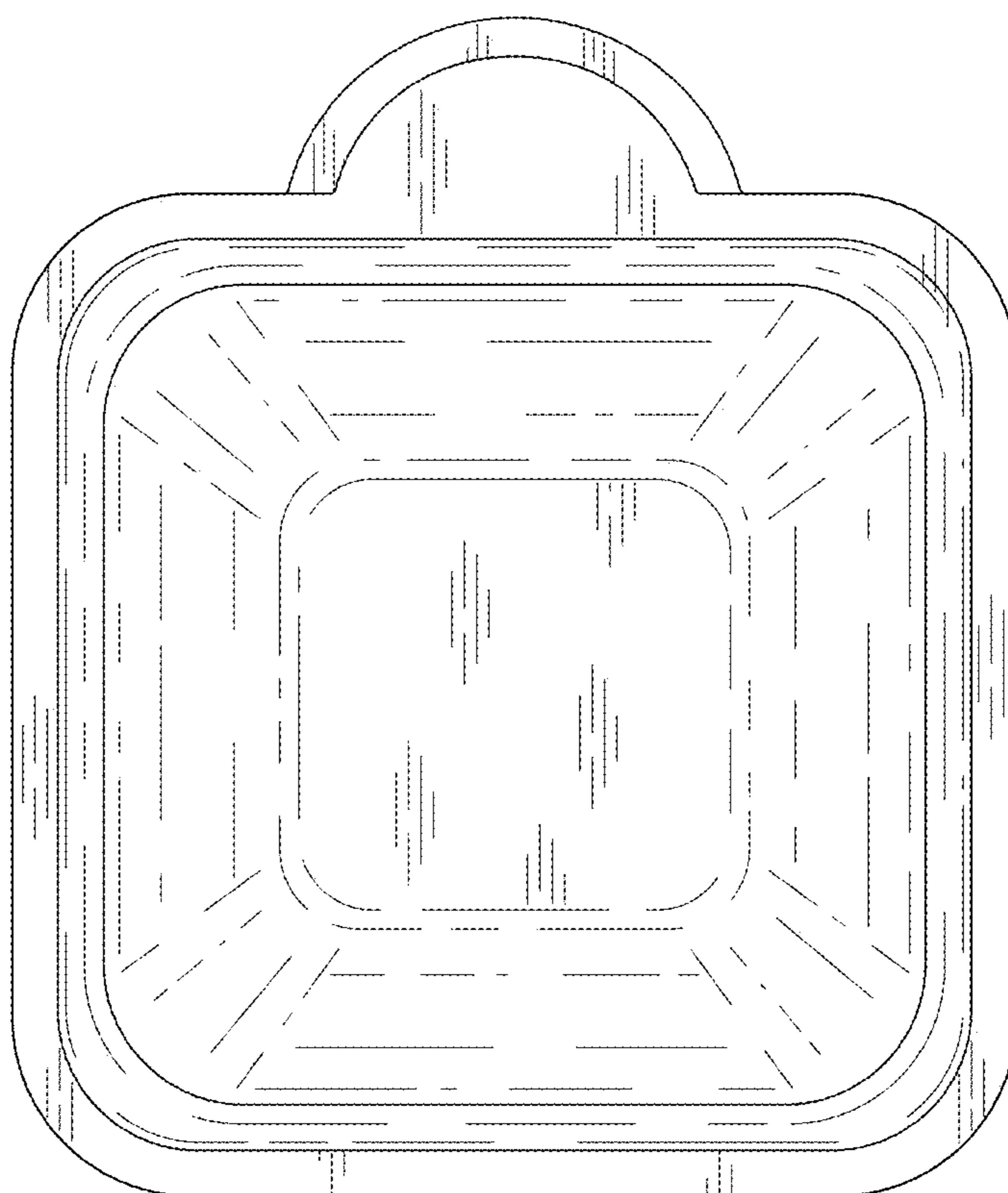

Fig. 8