



US00D925310S

(12) **United States Design Patent**
Lowrey

(10) **Patent No.:** **US D925,310 S**

(45) **Date of Patent:** **** Jul. 20, 2021**

(54) **WIRE STRAINER**

(71) Applicant: **Wireman Pty Limited**, Milsons Point (AU)

(72) Inventor: **Ian Lowrey**, Surry Hills (AU)

(73) Assignee: **International Moulded Plastics Pty Limited**

(**) Term: **15 Years**

(21) Appl. No.: **29/686,578**

(22) Filed: **Apr. 5, 2019**

(30) **Foreign Application Priority Data**

Oct. 5, 2018 (AU) 201815956
Mar. 7, 2019 (AU) 201911208

(51) **LOC (13) Cl.** **08-05**

(52) **U.S. Cl.**
USPC **D8/44**

(58) **Field of Classification Search**
USPC D8/14, 44, 51
CPC F16G 11/12; F16G 11/10; B25B 25/00
See application file for complete search history.

(56) **References Cited**

U.S. PATENT DOCUMENTS

1,443,064 A * 1/1923 Wilson F16G 11/12
254/254
1,497,566 A * 6/1924 Ironside F16G 11/12
254/259

2,772,070 A * 11/1956 Stevenson F16G 11/12
254/199
3,341,177 A * 9/1967 Weise F16G 11/12
254/246
D298,727 S * 11/1988 Hansson D8/356
D875,493 S * 2/2020 Fox D8/44

* cited by examiner

Primary Examiner — Philip S Hyder

(74) *Attorney, Agent, or Firm* — Design IP

(57) **CLAIM**

The ornamental design for a wire strainer, as shown and described.

DESCRIPTION

FIG. 1 is a perspective front view of a wire strainer showing my new design with the wire holding jaws in an open position;
FIG. 2 is a front view thereof;
FIG. 3 is a rear view thereof;
FIG. 4 is a left side view thereof;
FIG. 5 is a right side view thereof;
FIG. 6 is a top view thereof;
FIG. 7 is a bottom view thereof; and,
FIG. 8 is a perspective front view thereof, with the wire holding jaws in a closed position.

1 Claim, 6 Drawing Sheets

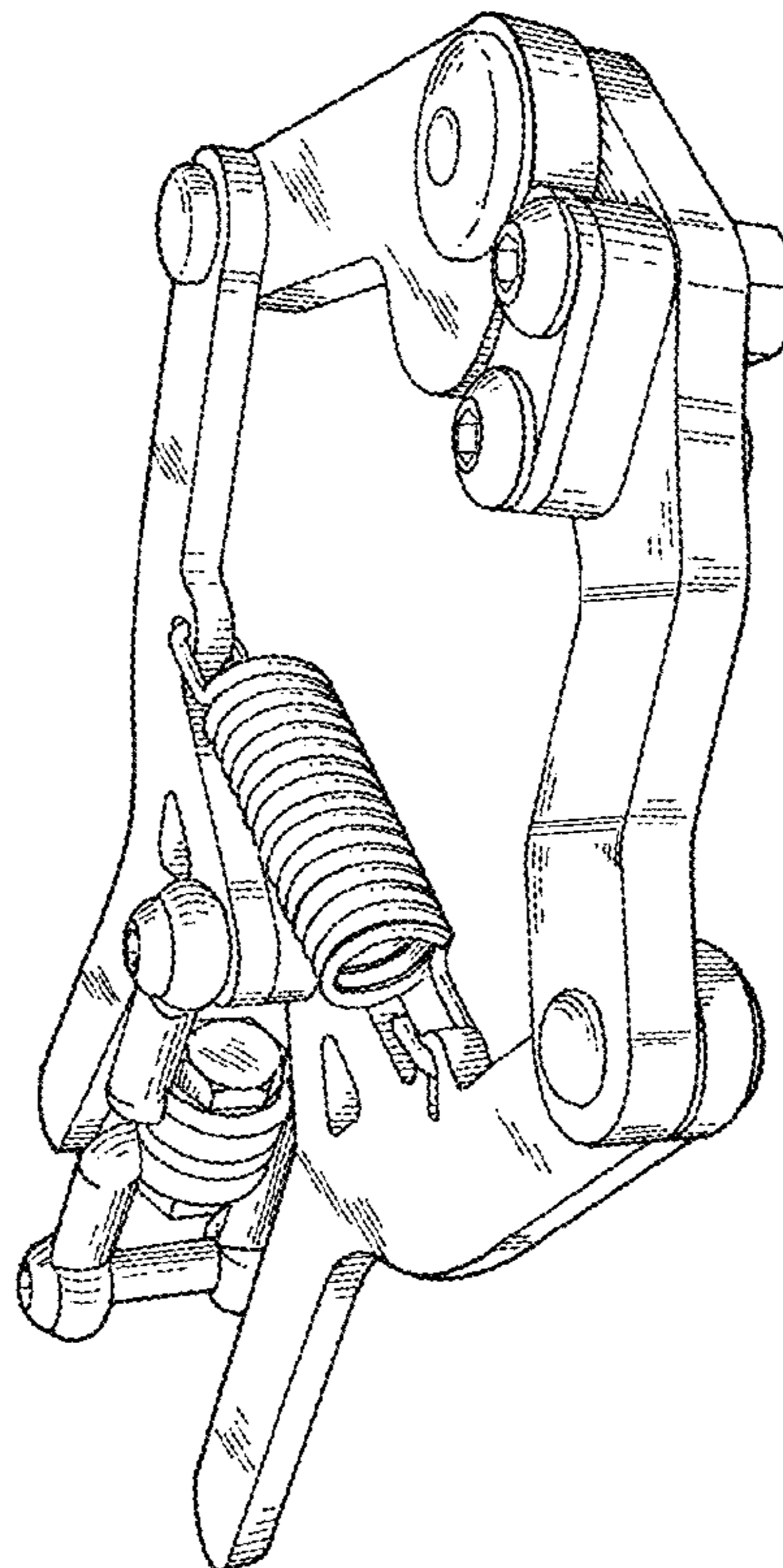

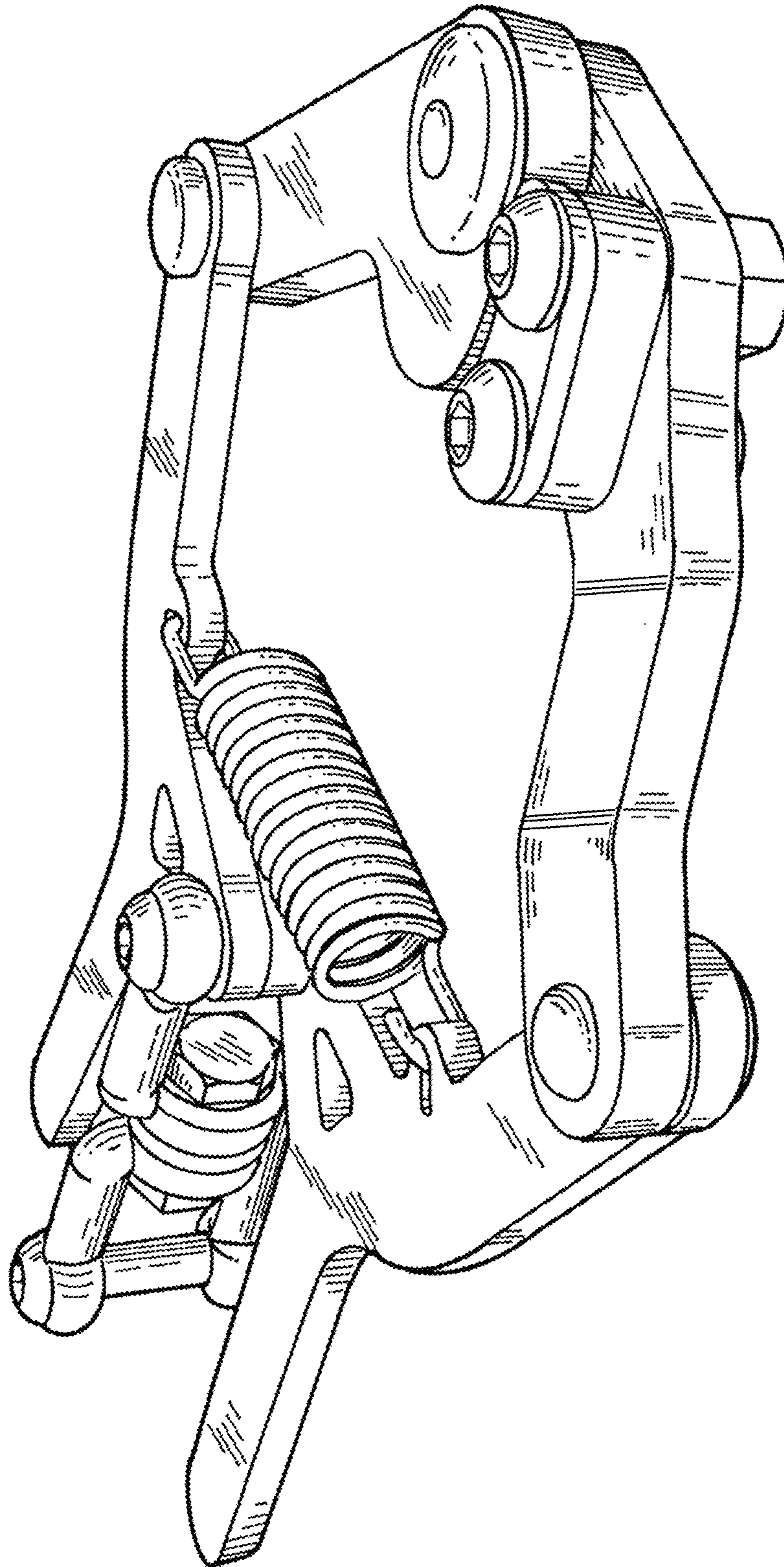

FIG. 1

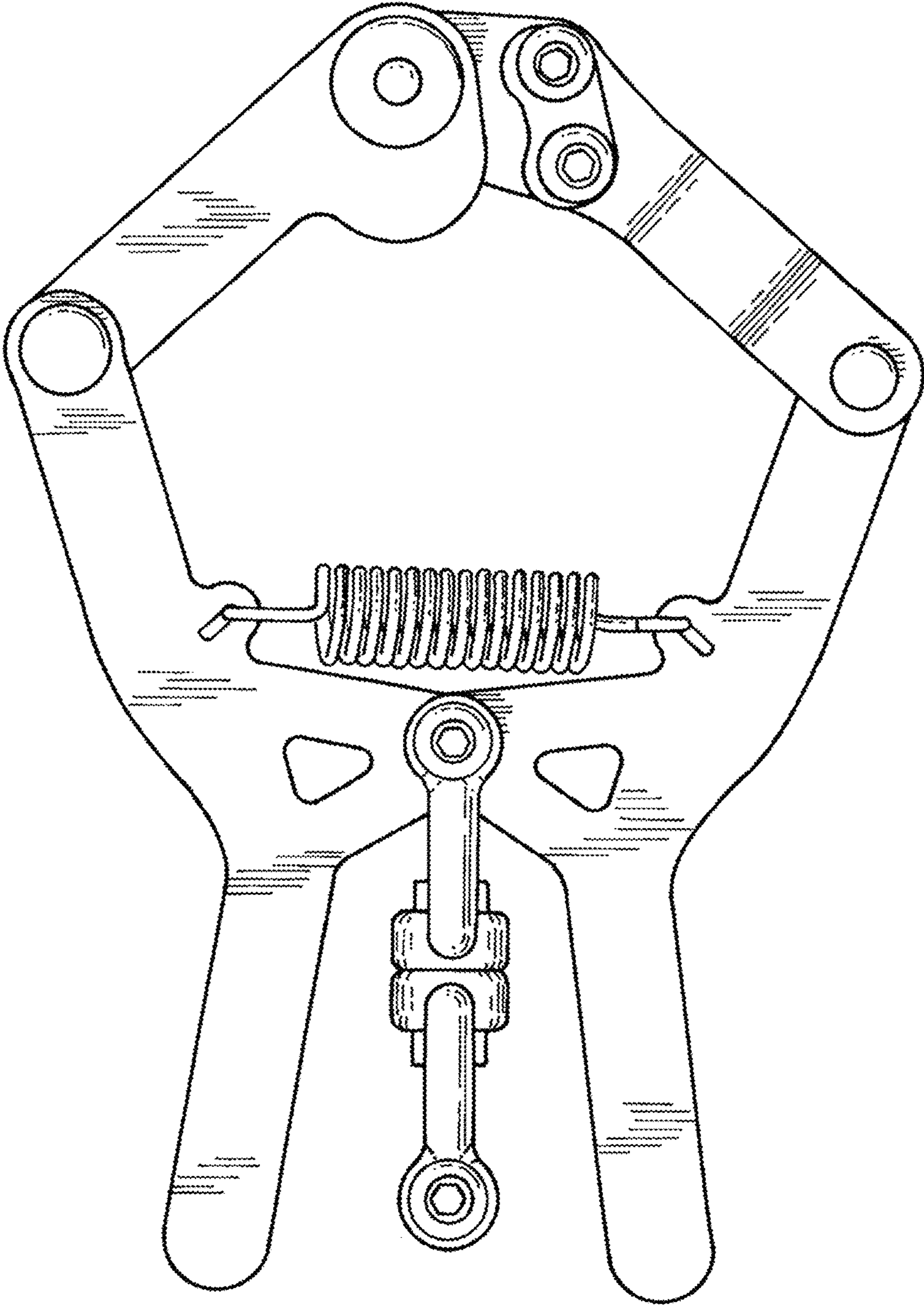

FIG. 2

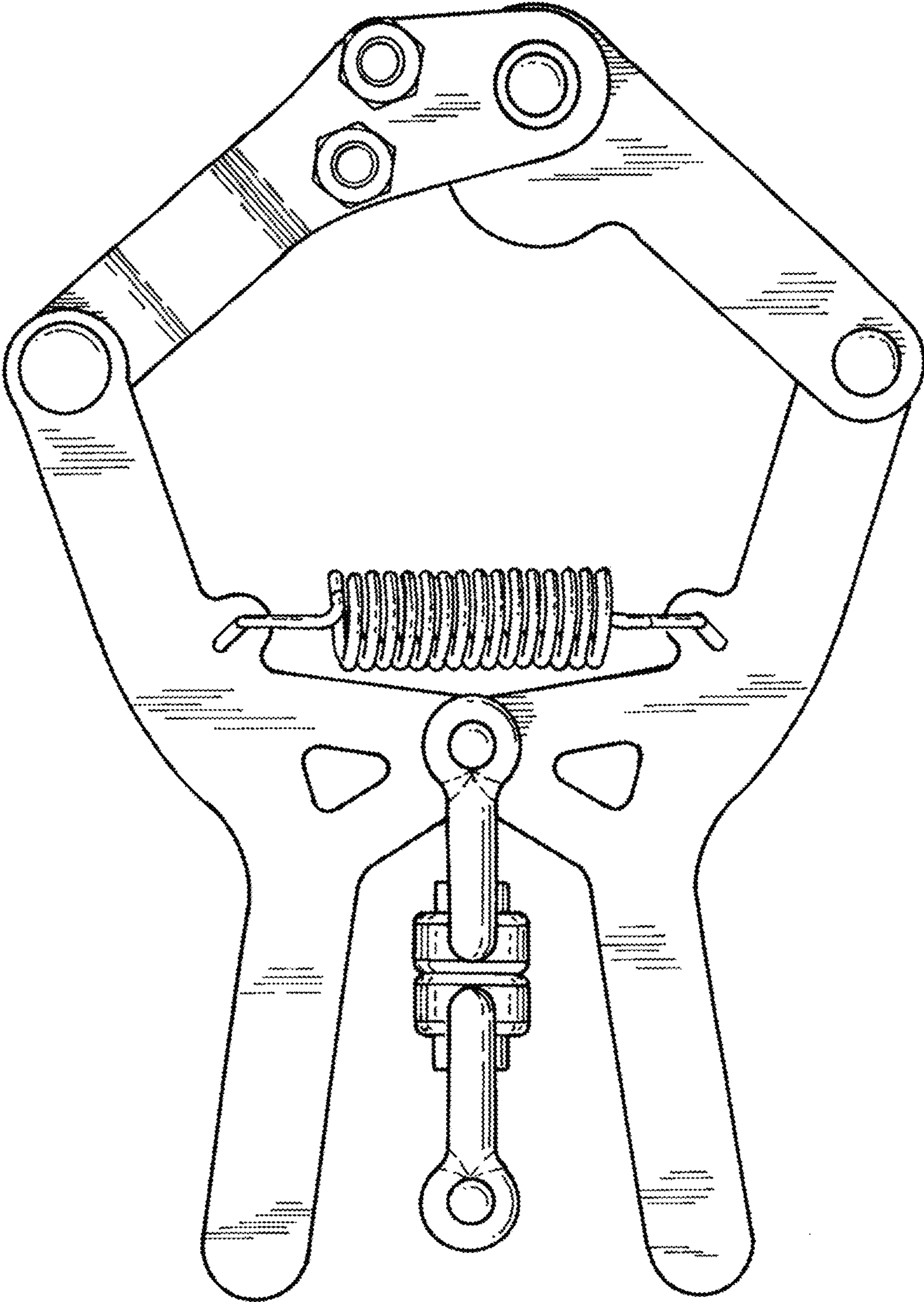

FIG. 3

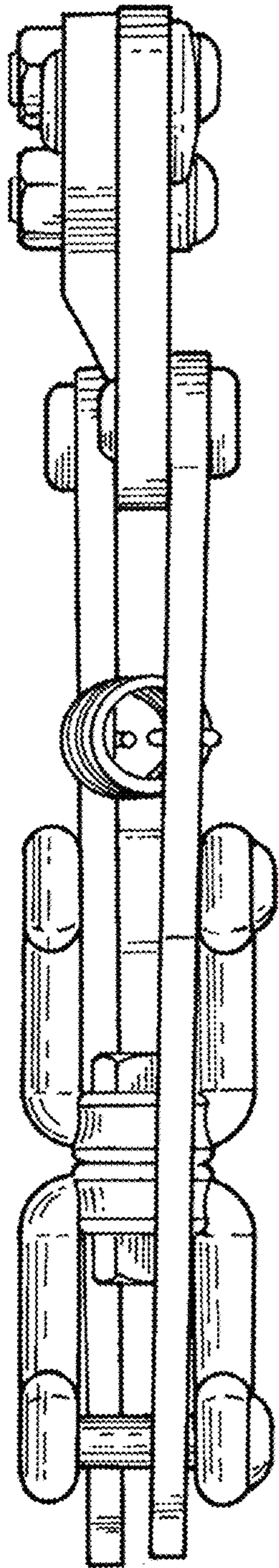

FIG. 4

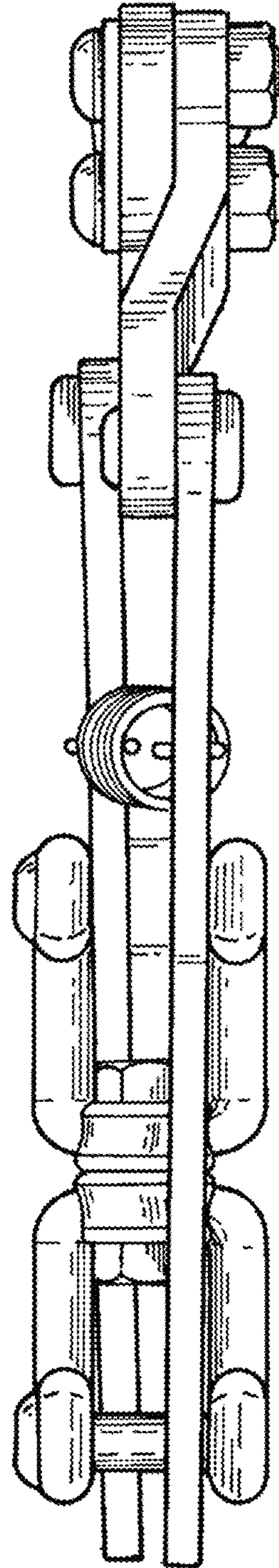

FIG. 5

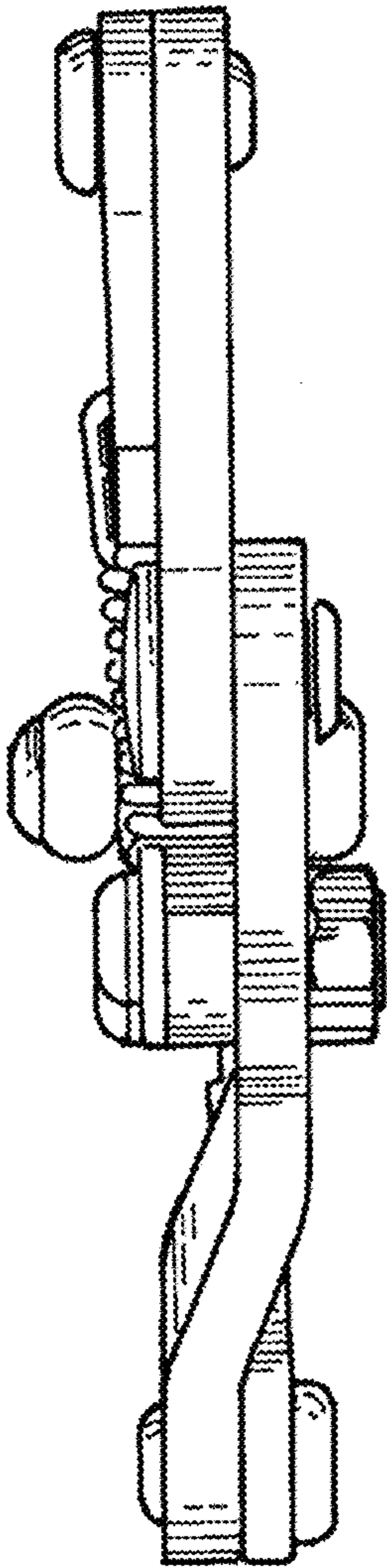

FIG. 6

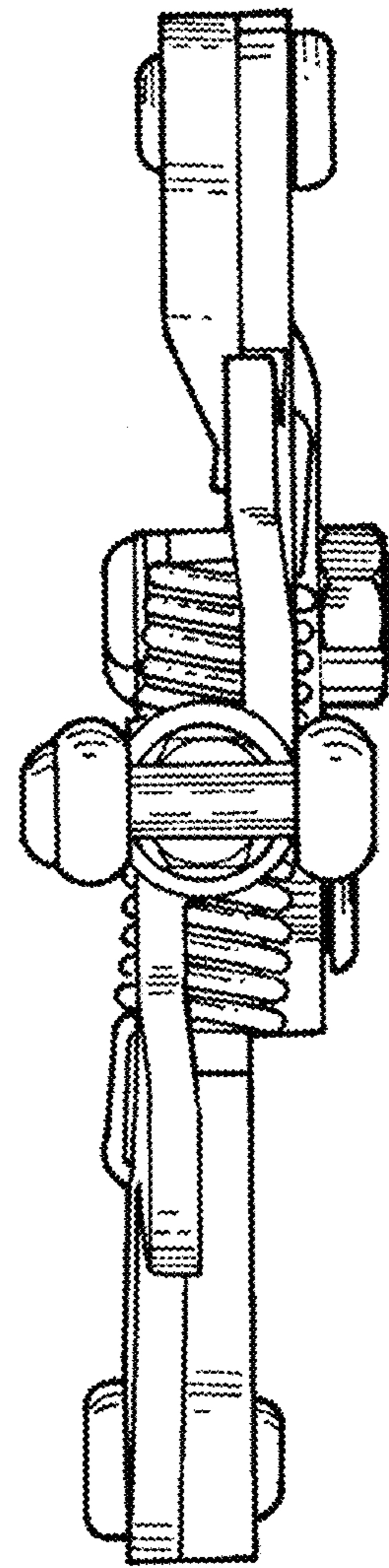

FIG. 7

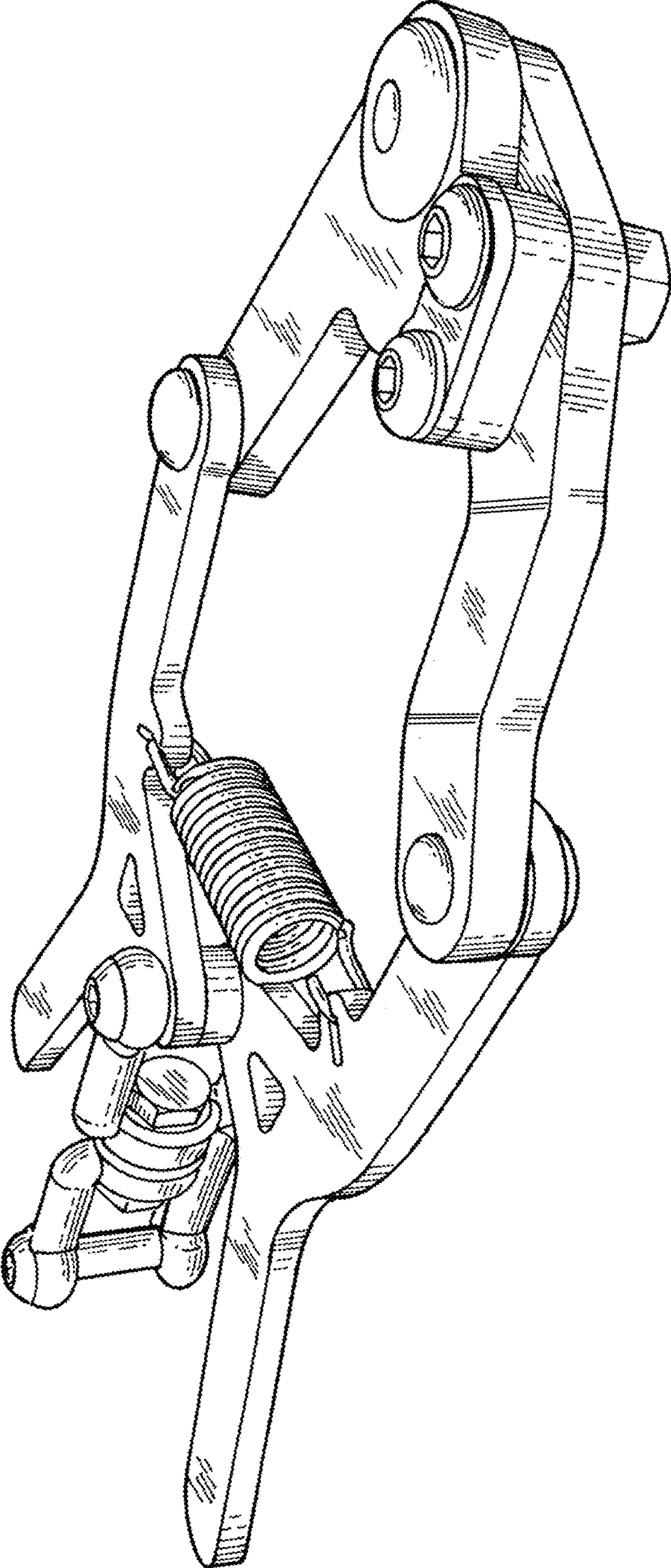

FIG. 8