



US00D925113S

(12) **United States Design Patent** (10) **Patent No.:** **US D925,113 S**  
**Kim** (45) **Date of Patent:** **\*\* Jul. 13, 2021**

(54) **ELECTRONIC CIGARETTE**  
(71) Applicant: **KT&G Corporation**, Daejeon (KR)  
(72) Inventor: **Min Chui Kim**, Yongin-si (KR)  
(73) Assignee: **KT&G Corporation**, Daejeon (KR)  
(\*\*) Term: **15 Years**

(21) Appl. No.: **29/709,909**  
(22) Filed: **Oct. 18, 2019**

(30) **Foreign Application Priority Data**  
Apr. 19, 2019 (KR) ..... 30-2019-0018628

(51) **LOC (13) Cl.** ..... **27-02**  
(52) **U.S. Cl.**  
USPC ..... **D27/162**

(58) **Field of Classification Search**  
USPC ..... D27/100, 101, 162, 163, 164, 165, 166, D27/167, 168, 169, 170, 171, 172, 173, D27/174, 175, 176, 177, 178, 179, 180, D27/181, 182, 183, 184, 185, 186, 187, D27/188, 189, 190, 191, 192, 193; D24/110, 110.5, 110.6; D28/91.1  
CPC ..... A24F 47/008; A24F 40/10; A24F 40/40; A24F 40/42; A24F 40/46; A24F 47/00; A24F 40/44; A24F 40/50; A24F 40/90; A24F 40/485; A24F 40/51; A24F 40/53; A24F 40/70; A24F 40/60; A24F 40/48; A24F 40/57; A24F 47/002; A24F 40/65; A24F 40/20; A24F 7/00; A24F 40/30; A24F 47/004; A24F 7/02; A24F 40/05; A24F 40/49; A24F 7/04; A24F 15/015; A24F 1/32; A24F 40/00; A24F 40/85; A24F 40/95; A24F 42/60; A24F 9/16; A61M 11/042; A61M 15/06; A61M 2205/8206; A61M 2205/3653; A61M 2016/0024; A61M 11/005; A61M 2016/0027; A61M 2205/587; A61M 11/003; A61M 11/044; A61M 15/002; A61M 15/0085; A61M 16/0003; A61M

(56) **References Cited**

U.S. PATENT DOCUMENTS

D343,123 S \* 1/1994 de Morgues ..... D9/529  
D767,821 S \* 9/2016 Clark ..... D27/189  
(Continued)

FOREIGN PATENT DOCUMENTS

CA 185291 \* 12/2019  
CN 201930566366.9 \* 5/2020  
(Continued)

*Primary Examiner* — Marissa J Cash  
*Assistant Examiner* — William B Melliar  
(74) *Attorney, Agent, or Firm* — Novick, Kim & Lee, PLLC; Sang Ho Lee; Hyun Woo Shin

(57) **CLAIM**

I claim the ornamental design for an electronic cigarette, as shown and described.

**DESCRIPTION**

FIG. 1 is a front, right perspective view of an electronic cigarette, showing my new design;  
FIG. 2 is a front elevational view thereof;  
FIG. 3 is a rear elevational view thereof;  
FIG. 4 is a left side elevational view thereof;  
FIG. 5 is a right side elevational view thereof;  
FIG. 6 is a top plan view thereof; and,  
FIG. 7 is a bottom plan view thereof.  
The broken lines in the drawings show portions of the electronic cigarette which form no part of the claimed design.

**1 Claim, 6 Drawing Sheets**

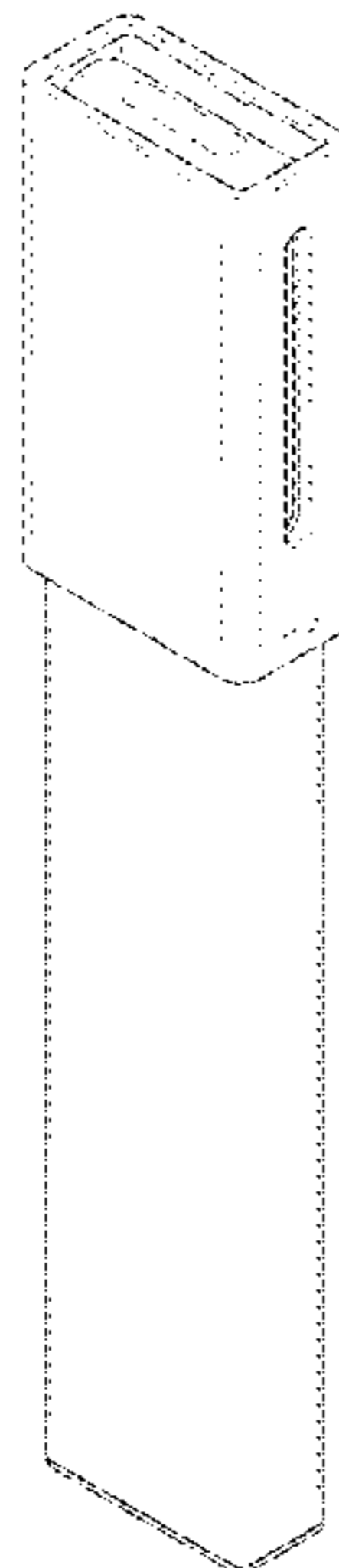

(58) **Field of Classification Search**

CPC .... 2205/8268; A61M 2209/02; A61M 11/041;  
A61M 15/0025; A61M 15/008; A61M  
2016/0033; A61M 2016/0039; A61M  
21/00; A61M 2205/0211; A61M  
2205/3331; A61M 2205/3334; A61M  
2205/3379; A61M 2205/52; A61M  
2205/58; A61M 2205/583; A61M  
2205/6018; A61M 2205/6054; A61M  
2205/75; A61M 2206/11; A61M 2206/20;  
A61M 2209/045; A24B 15/167; A24B  
15/16; A24B 15/18; A24B 15/303; A24B  
15/308; A24B 15/34; A24D 3/10; A24D  
3/048

See application file for complete search history.

(56)

**References Cited**

U.S. PATENT DOCUMENTS

D802,838 S \* 11/2017 Clark ..... D27/189  
D865,276 S \* 10/2019 Pino ..... D27/162

D870,374 S \* 12/2019 Greenbaum ..... D27/169  
D870,961 S \* 12/2019 Levinson ..... D27/162  
D875,306 S \* 2/2020 Pan ..... D27/167  
D889,736 S \* 7/2020 Han ..... D27/162  
D889,737 S \* 7/2020 Vora ..... D27/162  
D898,278 S \* 10/2020 Carlberg ..... D27/162  
D904,681 S \* 12/2020 Kim ..... D27/162  
D904,682 S \* 12/2020 Kim ..... D27/162  
D904,683 S \* 12/2020 Kim ..... D27/162  
D905,330 S \* 12/2020 Kim ..... D27/162  
D910,908 S \* 2/2021 Kim ..... D27/162  
2018/0077967 A1 \* 3/2018 Hatton ..... A24F 47/008  
2019/0029319 A1 \* 1/2019 Moorman ..... A24F 7/04

FOREIGN PATENT DOCUMENTS

EM 004725950-0005 \* 8/2020  
KR 3020190007339 \* 6/2020

\* cited by examiner

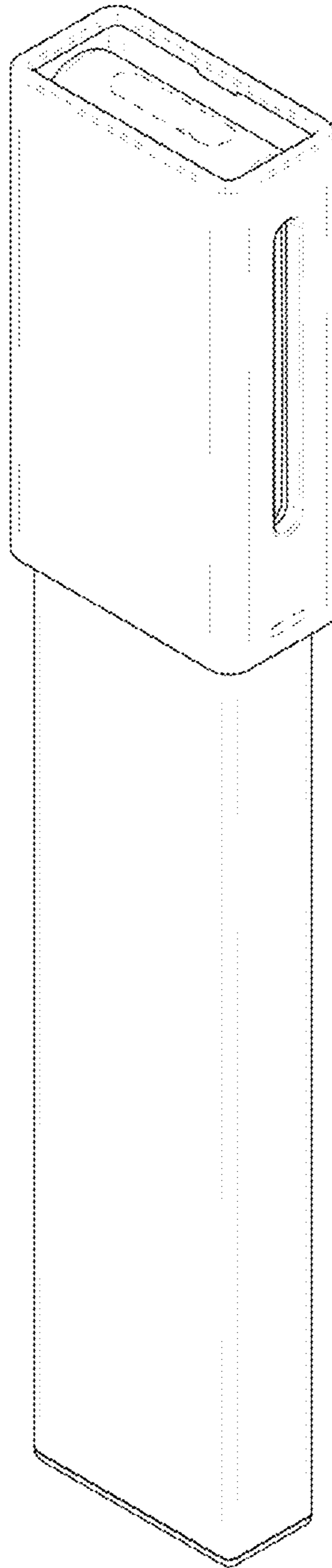

**FIG. 1**

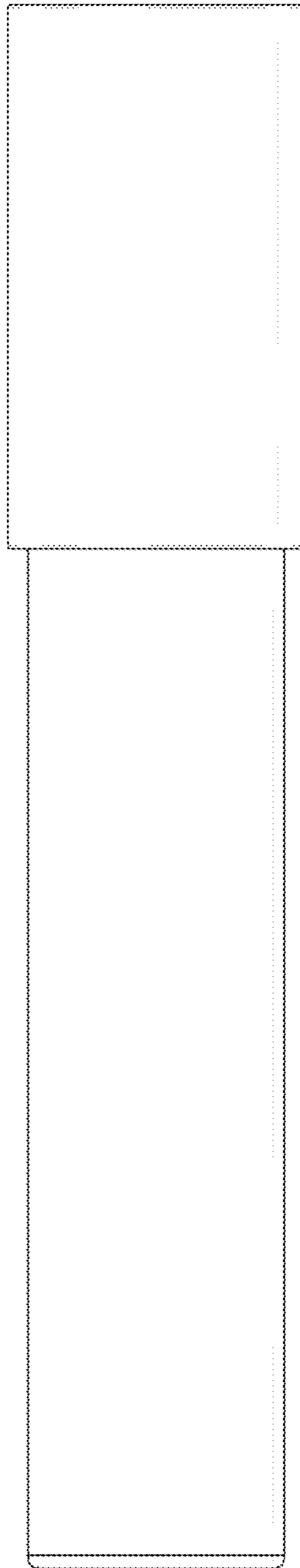

**FIG. 2**

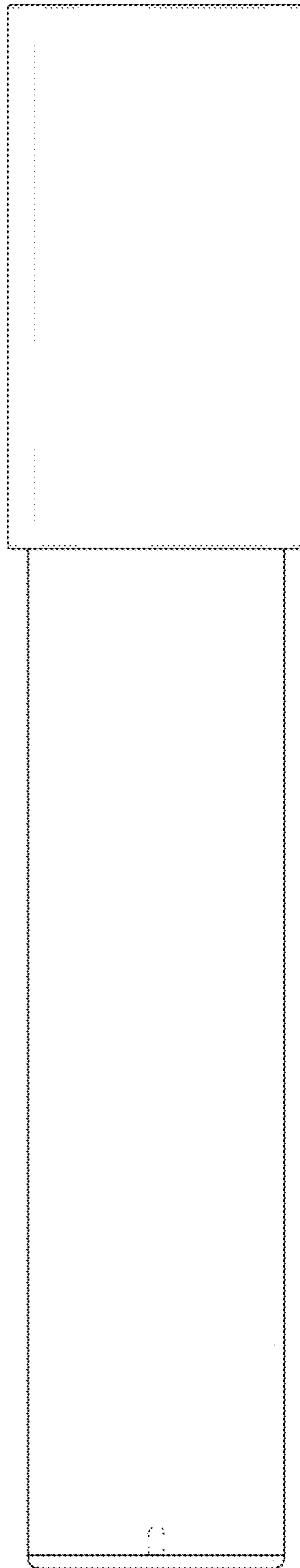

**FIG. 3**

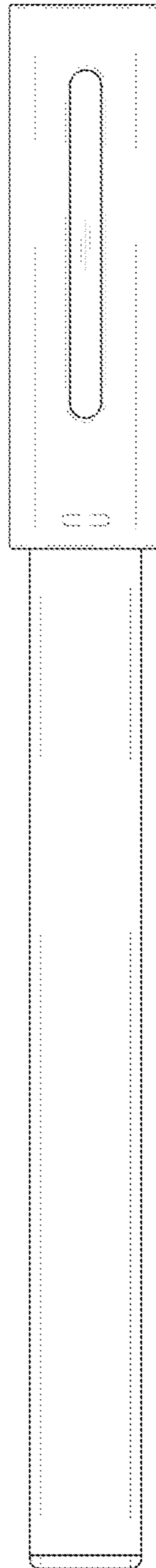

**FIG. 4**

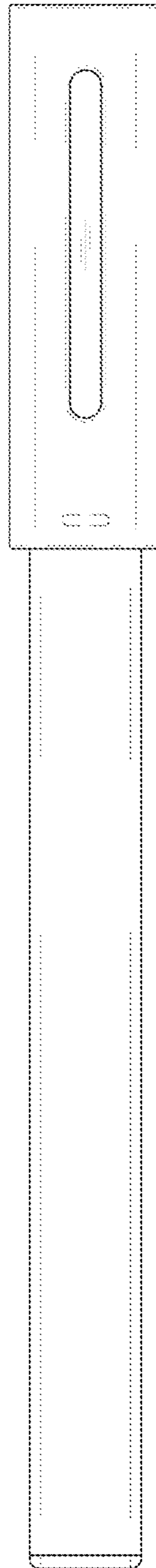

**FIG. 5**

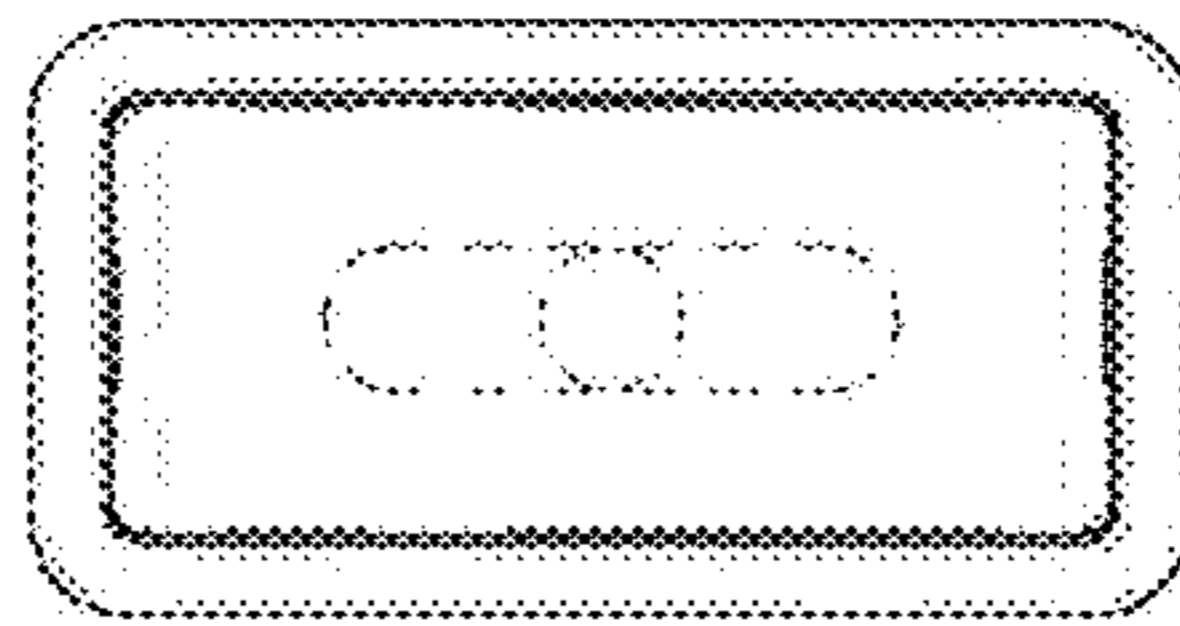

**FIG. 6**

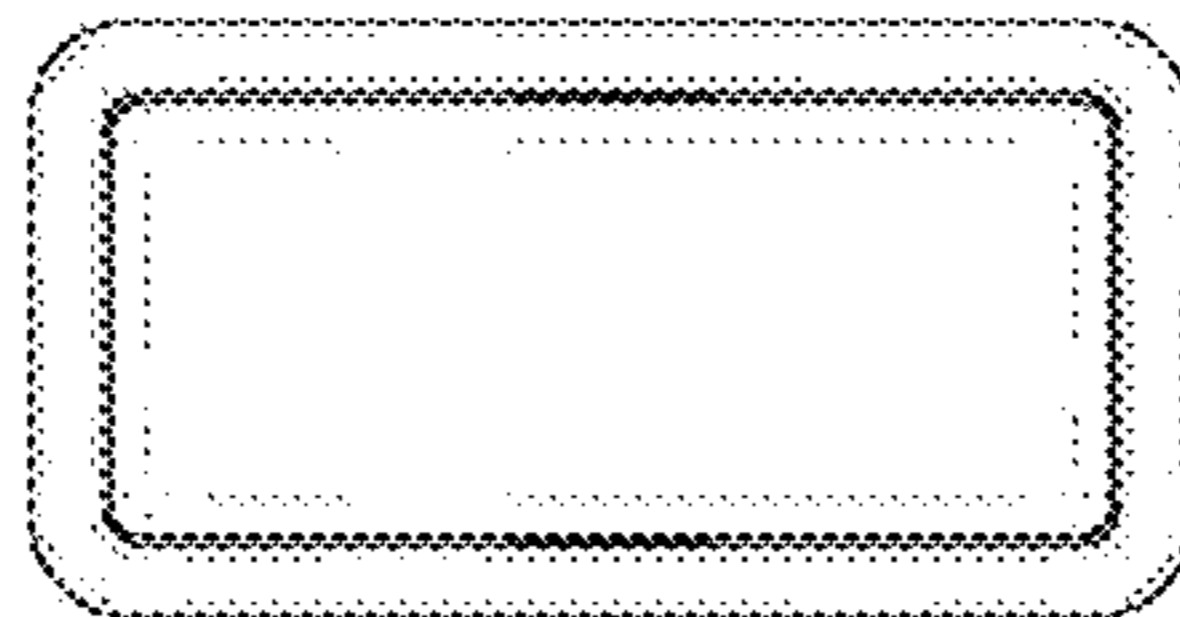

**FIG. 7**