



US00D925074S

(12) **United States Design Patent** (10) **Patent No.:** **US D925,074 S**  
**Wu** (45) **Date of Patent:** **\*\* Jul. 13, 2021**

(54) **SCENTED JAR CANDLE** D802,180 S \* 11/2017 Li ..... F21V 1/00  
D26/4  
(71) Applicant: **AE TECHNOLOGIES CO., LTD.,** D810,265 S \* 2/2018 Chen ..... A61L 9/122  
Guangdong (CN) D23/366  
D834,694 S \* 11/2018 Walter ..... F21S 9/02  
D23/366

(72) Inventor: **Wenfeng Wu**, Guangdong (CN)

(Continued)

(73) Assignee: **AE TECHNOLOGIES CO., LTD.,**  
Guangzhou (CN)

**OTHER PUBLICATIONS**

(\*\*) Term: **15 Years**

Youtube, "Bamboo Ultrasonic Essential Oil Diffuser by NOW Foods", first available May 18, 2016. (<https://www.youtube.com/watch?v=OIC9ZDbar70>) (Year: 2016).\*

(21) Appl. No.: **29/706,906**

(Continued)

(22) Filed: **Sep. 24, 2019**

(30) **Foreign Application Priority Data**

*Primary Examiner* — April Rivas  
*Assistant Examiner* — Justin A Johnson

Sep. 18, 2019 (CN) ..... 201930512595.2

(51) **LOC (13) Cl.** ..... **26-04**

(52) **U.S. Cl.**  
USPC ..... **D26/7; D23/367**

(58) **Field of Classification Search**  
USPC ..... D1/106, 107, 108, 109, 114, 115;  
D26/1-17, 19-24, 28-38, 40, 41, 43-45,  
D26/51, 55, 72, 74; D9/516, 517, 519,  
D9/556, 557, 558, 574; D23/314, 355,  
D23/364, 366, 367

(57) **CLAIM**

The ornamental design for a scented jar candle, as shown and described.

CPC ..... F21H 1/00; F21H 1/02; F21H 1/04; F21H 5/00; F21H 7/00; F21L 2/00; F21L 19/00; F21L 19/003; F21L 19/006; F21S 2/00; F21S 2/005; F21S 6/00; F21S 6/001; F21S 9/00; F21S 9/02; F21S 43/00; F21V 15/00; F21V 35/00; F21V 35/003; F21V 35/006; F21V 37/0095; F21W 2103/00; F21W 2103/20; F21W 2121/00; F21W 2121/002; F21W 2121/04; H01K 5/00

**DESCRIPTION**

FIG. 1 is a front elevational view of a scented jar candle showing my new design;  
FIG. 2 is a rear elevational view thereof;  
FIG. 3 is a left side view thereof;  
FIG. 4 is a right side view thereof;  
FIG. 5 is a top plan view thereof;  
FIG. 6 is a bottom plan view thereof;  
FIG. 7 is a top and rear perspective view thereof; and,  
FIG. 8 is a bottom, front and right side perspective view thereof.

See application file for complete search history.

The broken lines in the drawings illustrate portions of the scented jar candle which form no part of the claimed design.

(56) **References Cited**

**U.S. PATENT DOCUMENTS**

6,991,452 B1 \* 1/2006 Semaan ..... B29C 53/086  
431/291  
D767,810 S \* 9/2016 Li ..... F21V 15/01  
D26/96

**1 Claim, 7 Drawing Sheets**

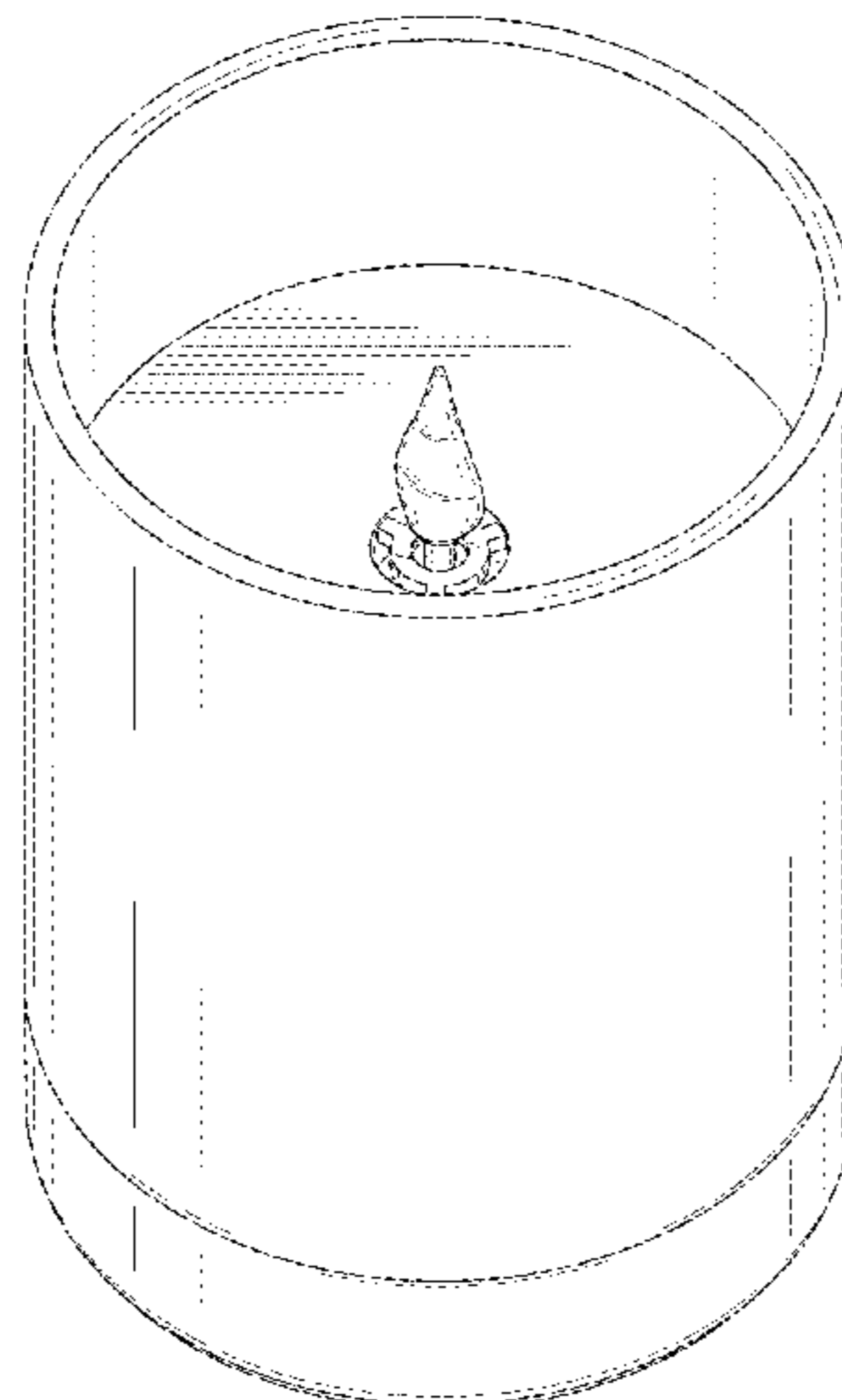

(56)

**References Cited**

## U.S. PATENT DOCUMENTS

D836,189 S \* 12/2018 Jakins ..... F21V 35/00  
D23/366  
D844,861 S \* 4/2019 Frankenhauser ..... D26/6  
D906,579 S \* 12/2020 Li ..... D26/96  
2010/0290238 A1 \* 11/2010 Howard ..... F21V 35/00  
362/392  
2012/0020052 A1 \* 1/2012 McCavit ..... A61L 9/122  
362/96  
2015/0103520 A1 \* 4/2015 Fournier ..... F21S 9/02  
362/190  
2020/0412281 A1 \* 12/2020 Li ..... F21V 1/00  
2021/0048173 A1 \* 2/2021 Li ..... F21V 15/01

## OTHER PUBLICATIONS

Amazon, "Flameless Led Candles Flickering, Yinuo Candle", first available Aug. 1, 2018. (<https://www.amazon.com/Flameless-Flickering-Candle-Wickless-Operated/dp/B07G34MDWC>) (Year: 2018).\*

Amazon, "Artmory Flameless Candles", first available Jun. 28, 2020. (<https://www.amazon.com/Artmory-Flameless-Candles-Electric-Operated/dp/B08B1RK1HX>) (Year: 2020).\*

Amazon, "ROGSFN Flameless Wax Led Candles", first available Jun. 31, 2020. (<https://www.amazon.com/dp/B08D8X6Y7S/?th=1>) (Year: 2020).\*

\* cited by examiner

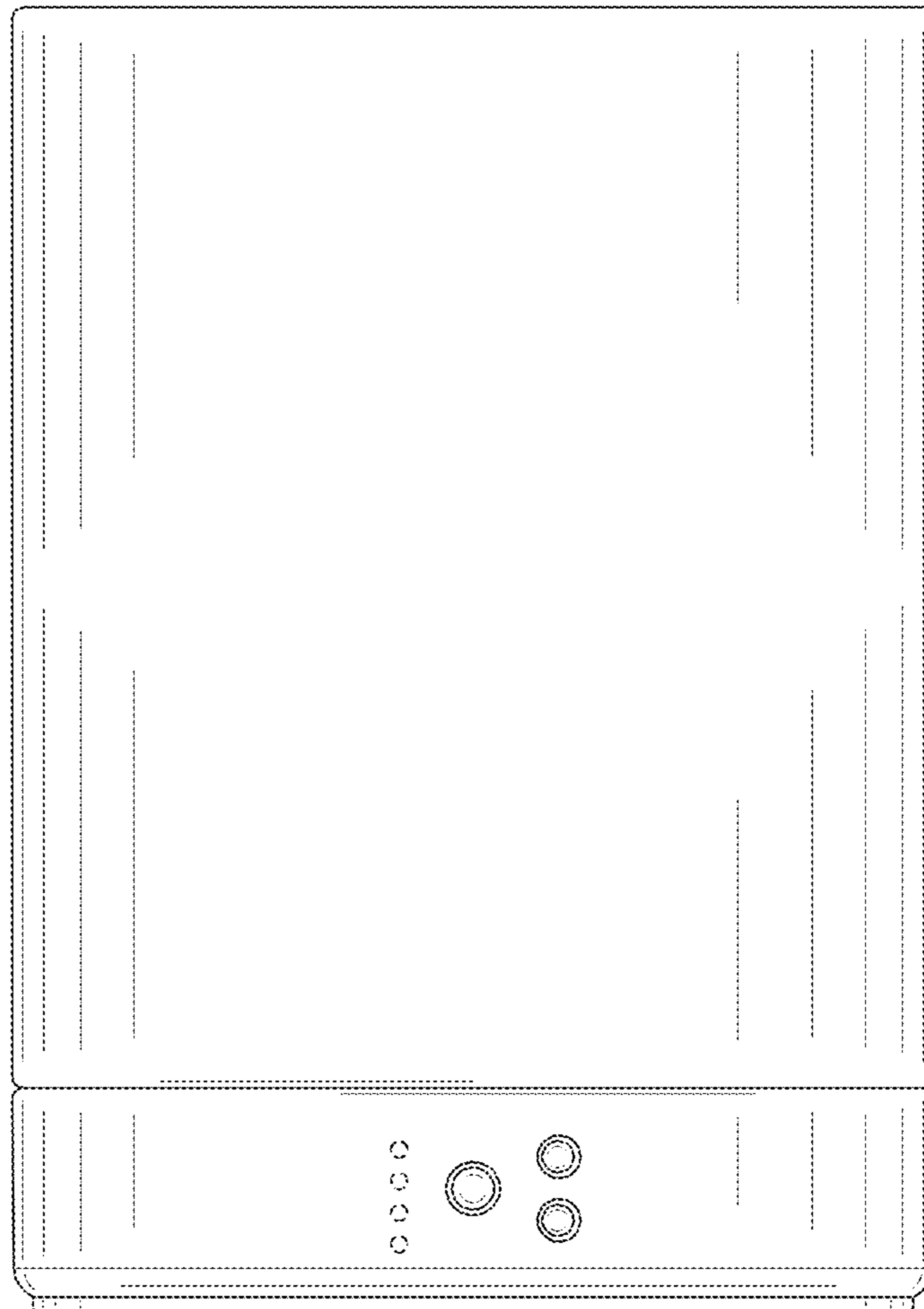

FIG.1

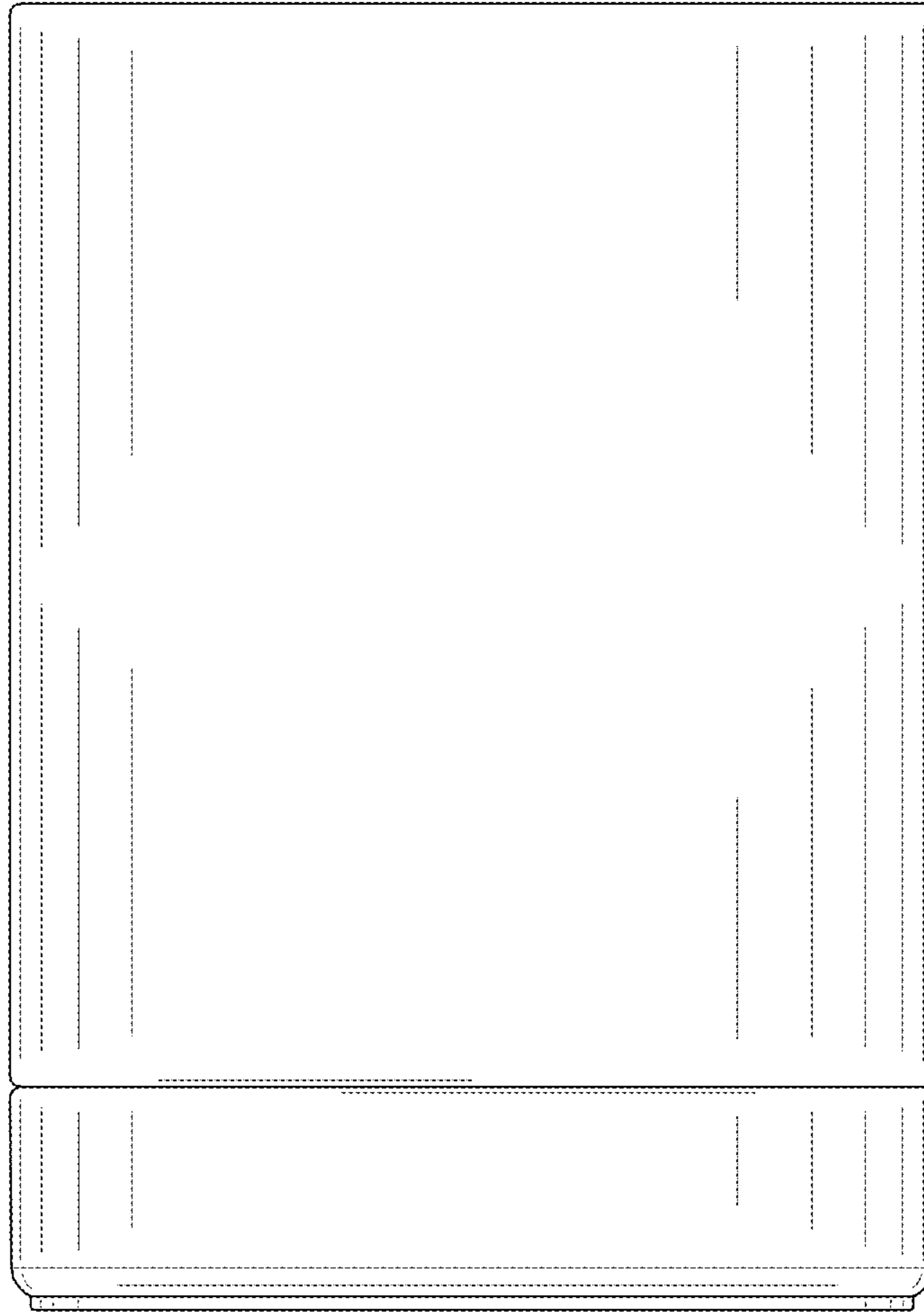

FIG.2

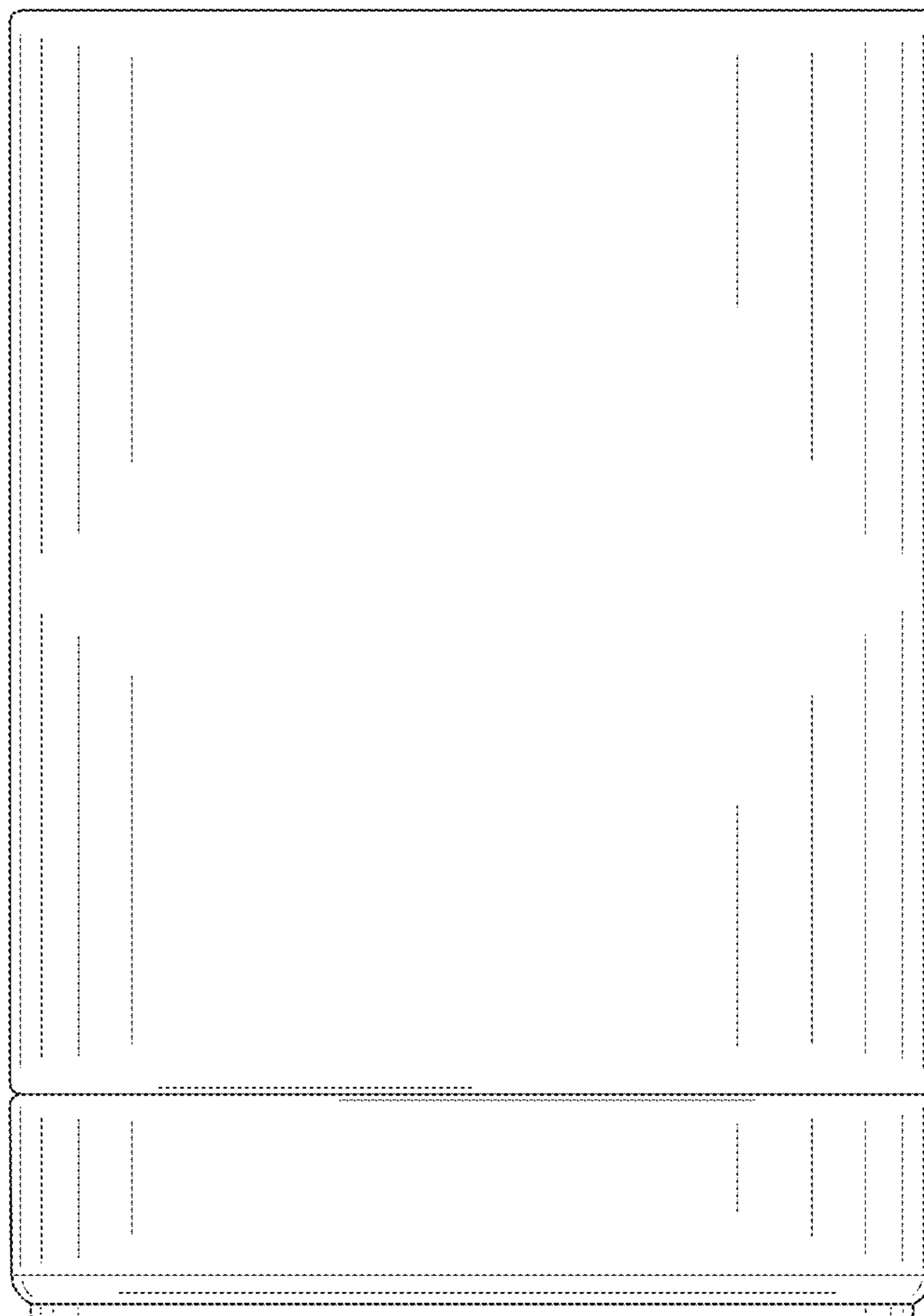

FIG.3

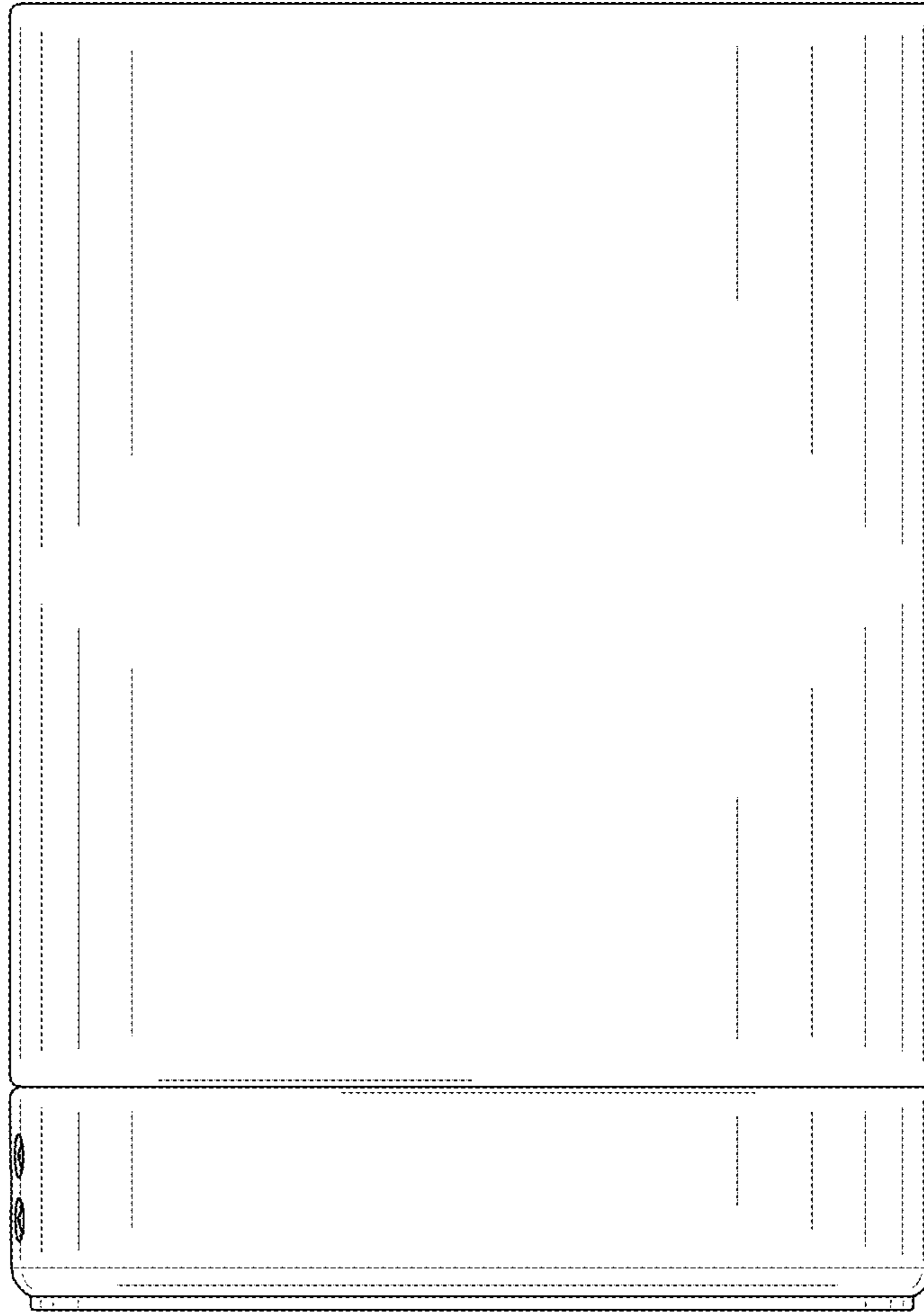

FIG.4

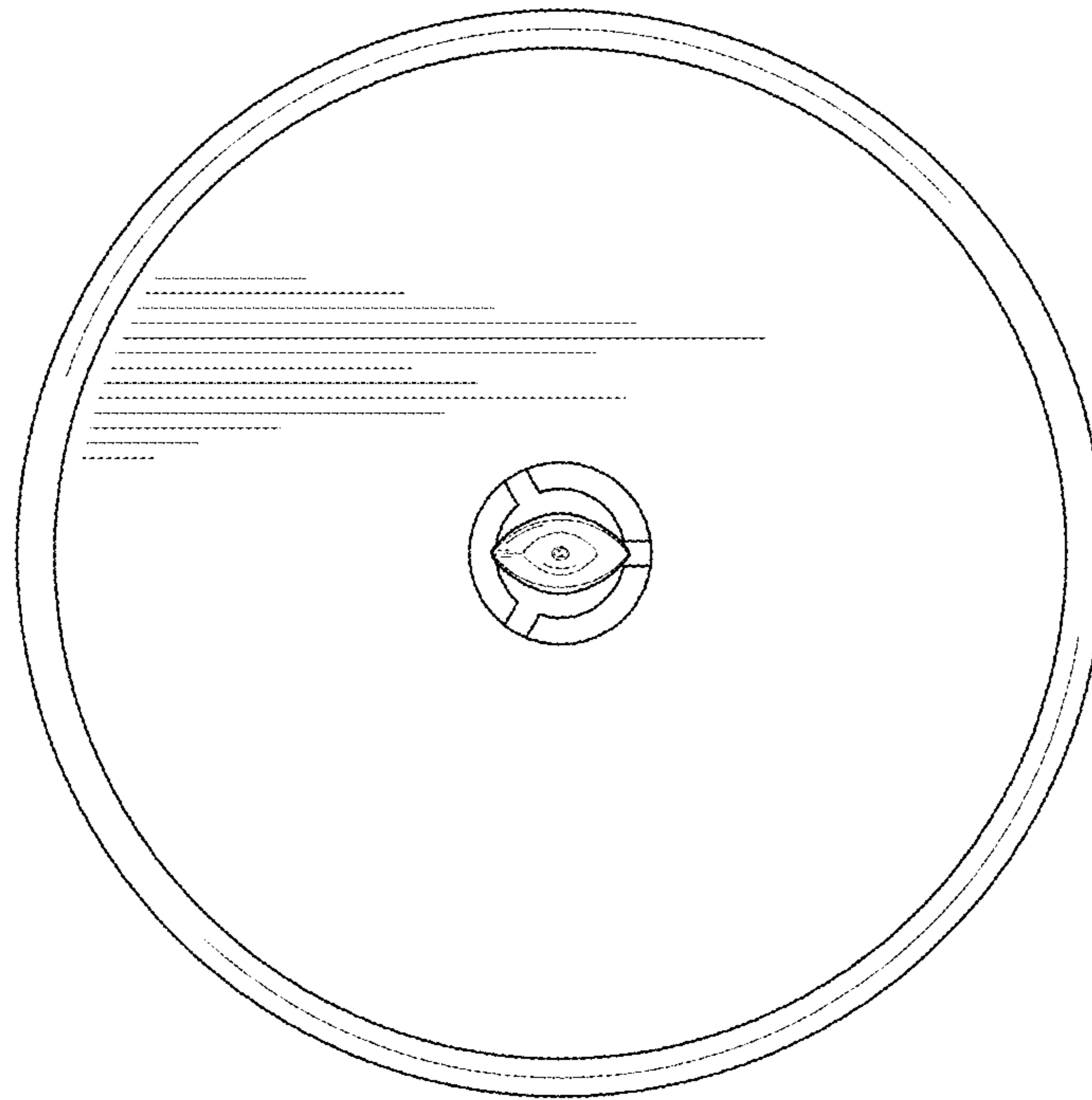

FIG.5

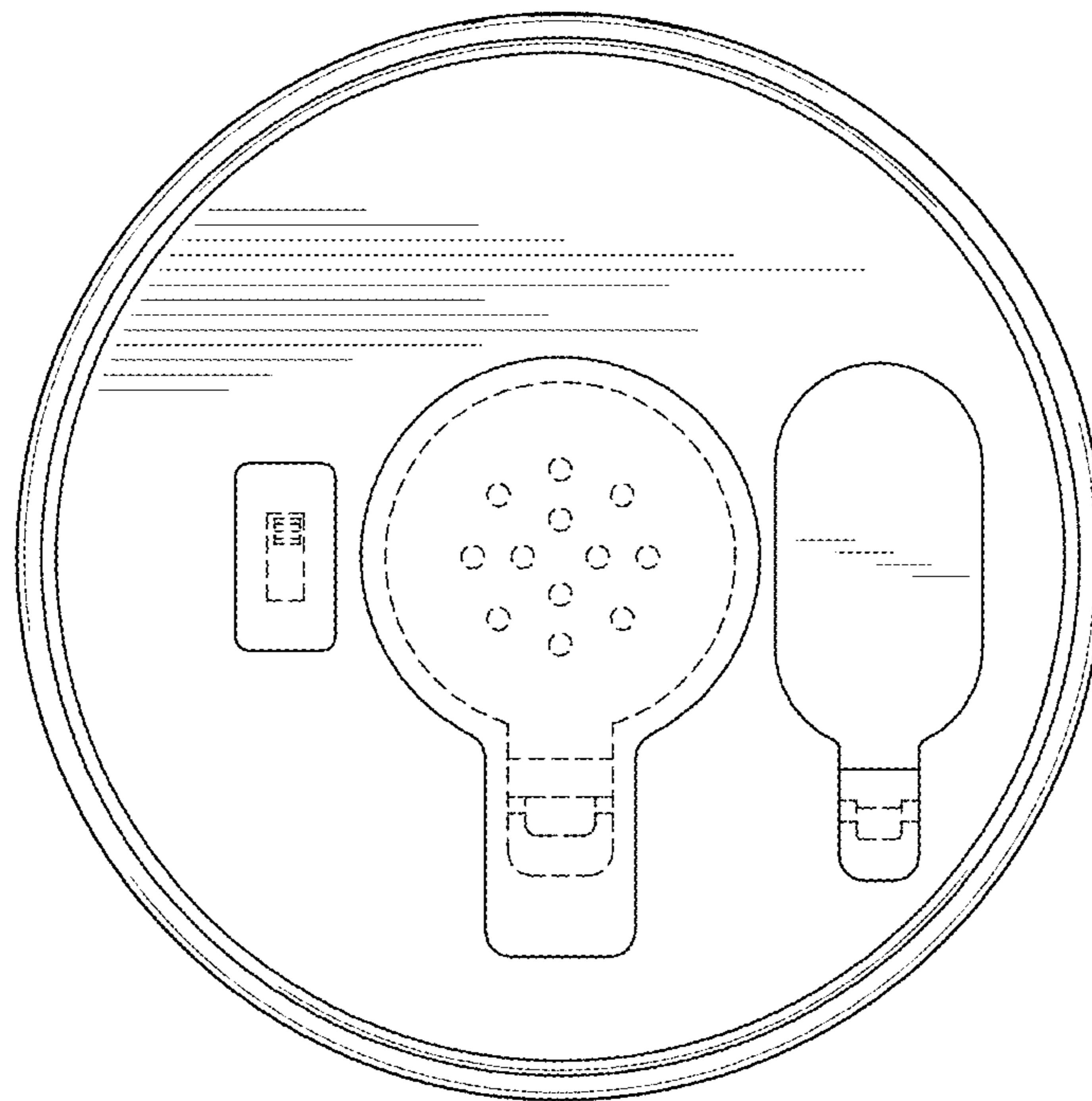

FIG.6

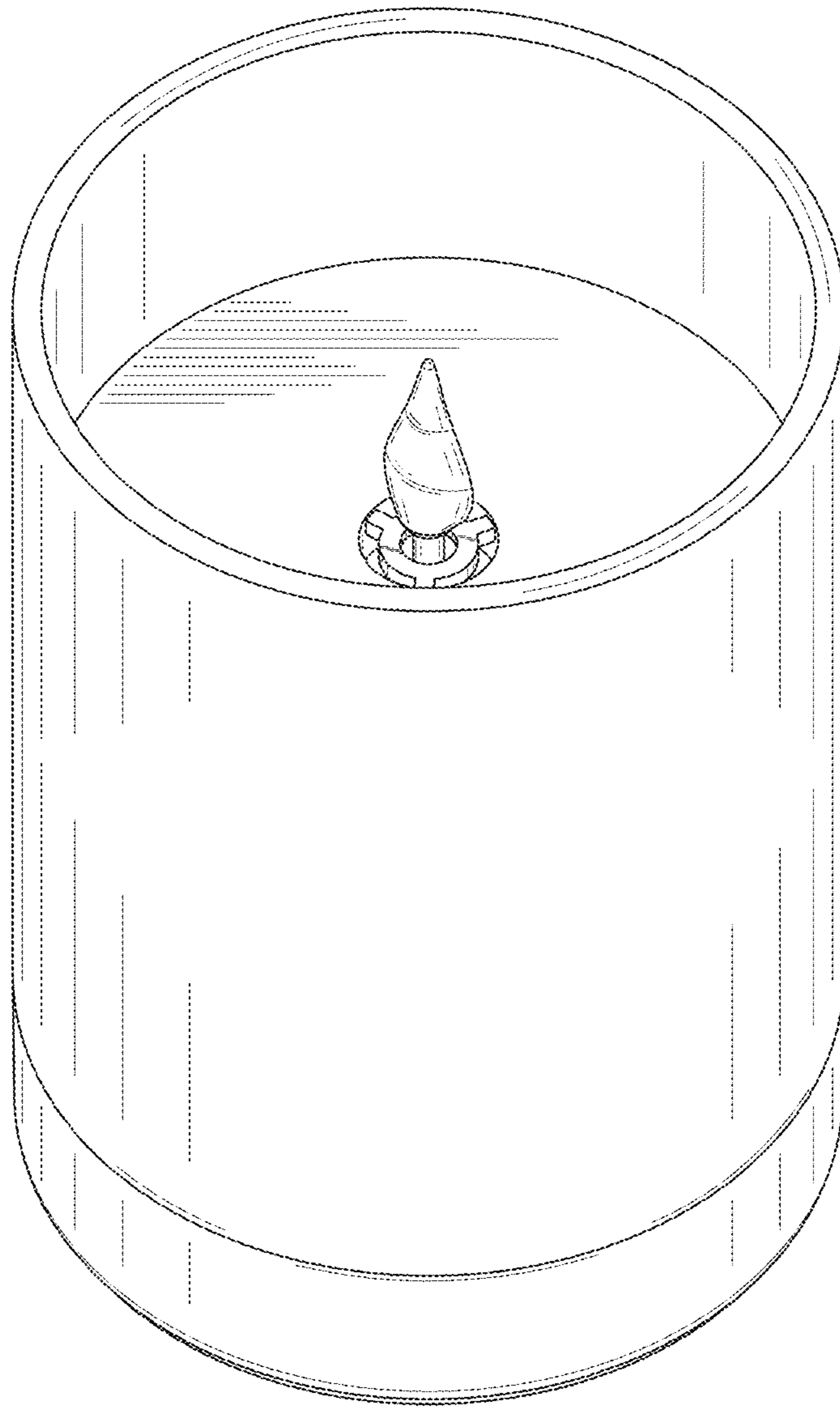

FIG.7



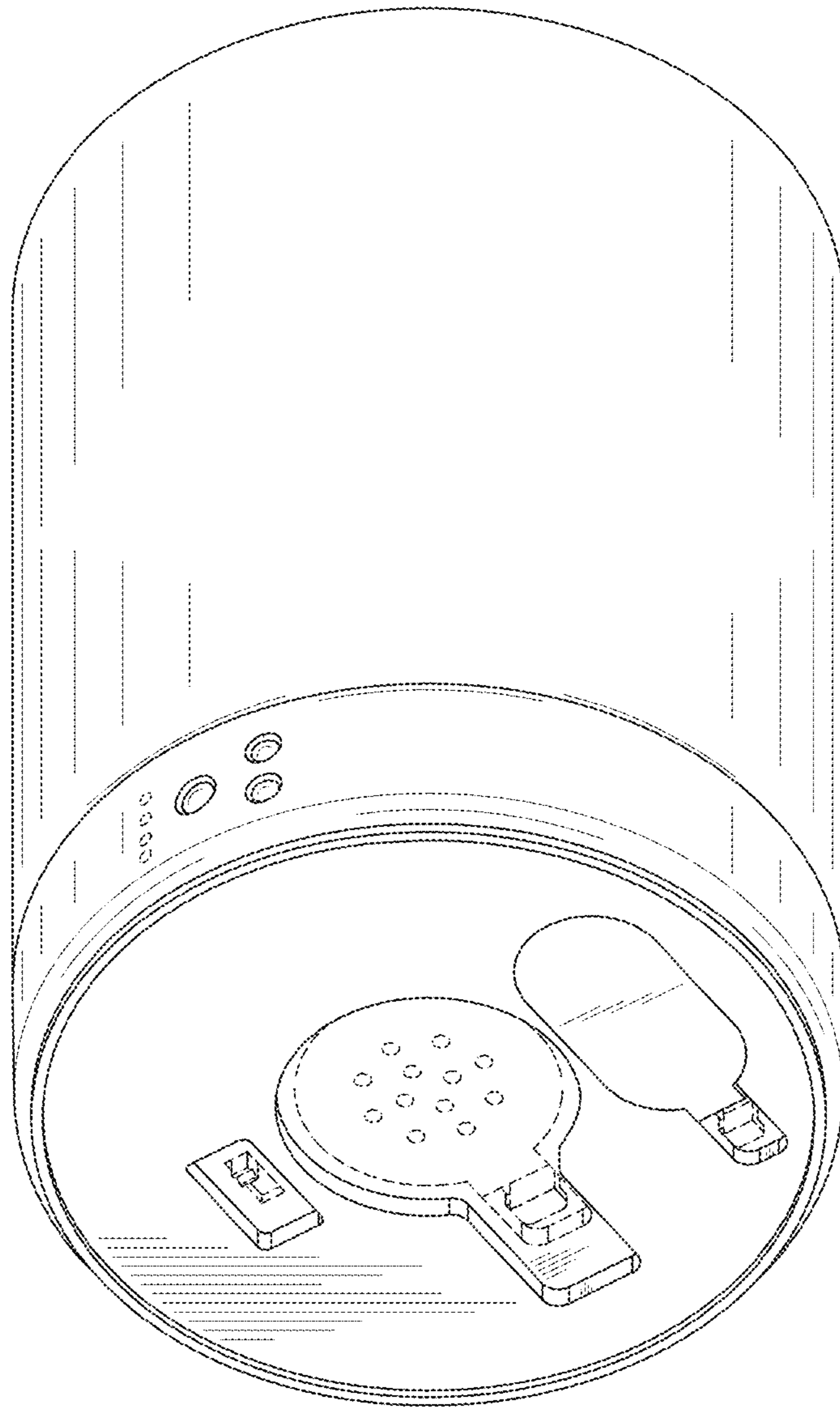

FIG.8