



US00D925059S

(12) **United States Design Patent** (10) **Patent No.:** **US D925,059 S**
Yoo et al. (45) **Date of Patent:** **** Jul. 13, 2021**

(54) **FEEDING BOTTLE STERILIZER**

(71) Applicant: **LG ELECTRONICS INC.**, Seoul (KR)

(72) Inventors: **Taewoo Yoo**, Seoul (KR); **Nayeoung Kim**, Seoul (KR); **Jinsu Kim**, Seoul (KR); **Kyoungmin Baek**, Seoul (KR); **Hyojin Won**, Seoul (KR); **Hyunwoo Yoo**, Seoul (KR); **Hyejin Choi**, Seoul (KR)

(73) Assignee: **LG ELECTRONICS INC.**, Seoul (KR)

D898,217 S * 10/2020 Hickey D24/217
D898,218 S * 10/2020 Hickey D24/217
D899,621 S * 10/2020 Maw D24/217
2011/0020193 A1* 1/2011 Lee A61L 2/07
422/300
2014/0271370 A1* 9/2014 Sirotin A61L 2/07
422/105
2017/0324267 A1* 11/2017 Decker A61L 2/26
2019/0099509 A1* 4/2019 Martz A61L 2/10

* cited by examiner

Primary Examiner — Anhdao Doan

(74) *Attorney, Agent, or Firm* — Birch, Stewart, Kolasch & Birch, LLP

(**) Term: **15 Years**

(21) Appl. No.: **29/711,212**

(22) Filed: **Oct. 29, 2019**

(30) **Foreign Application Priority Data**

Apr. 30, 2019 (WO) 83082

(51) **LOC (13) Cl.** **24-01**

(52) **U.S. Cl.**
USPC **D24/217**

(58) **Field of Classification Search**
USPC D24/216, 217, 218, 219, 232, 227–230,
D24/197–199; D32/1
CPC A61L 2/26; A61L 2/24; A61L 2/17; A61L
2/18; A61L 2/025; A61L 2202/122; A61L
2202/10; A61L 2202/11; A61L 2202/14;
A61L 2202/23; A61L 2202/24; A61L
2202/182

See application file for complete search history.

(56) **References Cited**

U.S. PATENT DOCUMENTS

4,710,233 A * 12/1987 Hohmann A61L 2/035
205/701
D893,043 S * 8/2020 Ou Yang D24/217

(57) **CLAIM**

The ornamental design for a feeding bottle sterilizer, as shown and described.

DESCRIPTION

FIG. 1 is a front perspective view of the feeding bottle sterilizer;
FIG. 2 is a front view thereof;
FIG. 3 is a rear view thereof;
FIG. 4 is a left view thereof where the right view is a mirror image;
FIG. 5 is a top view thereof;
FIG. 6 is a bottom view thereof;
FIG. 7 is a right top perspective view thereof; and,
FIG. 8 is a left top perspective view thereof.
The broken lines depict portions of the feeding bottle sterilizer that form no part of the claimed design. The broken lines form no part of the claimed design.

1 Claim, 8 Drawing Sheets

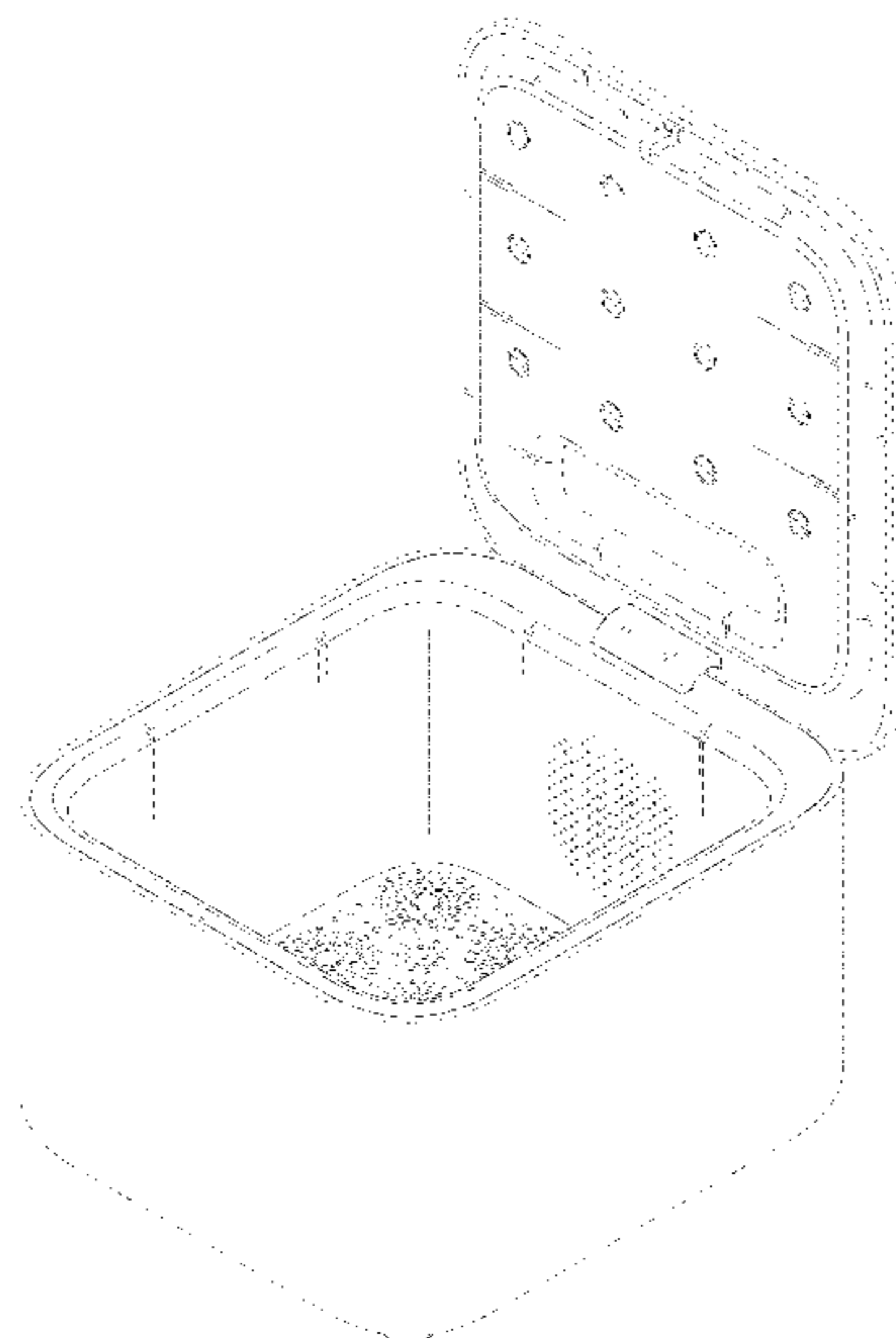

FIG. 1

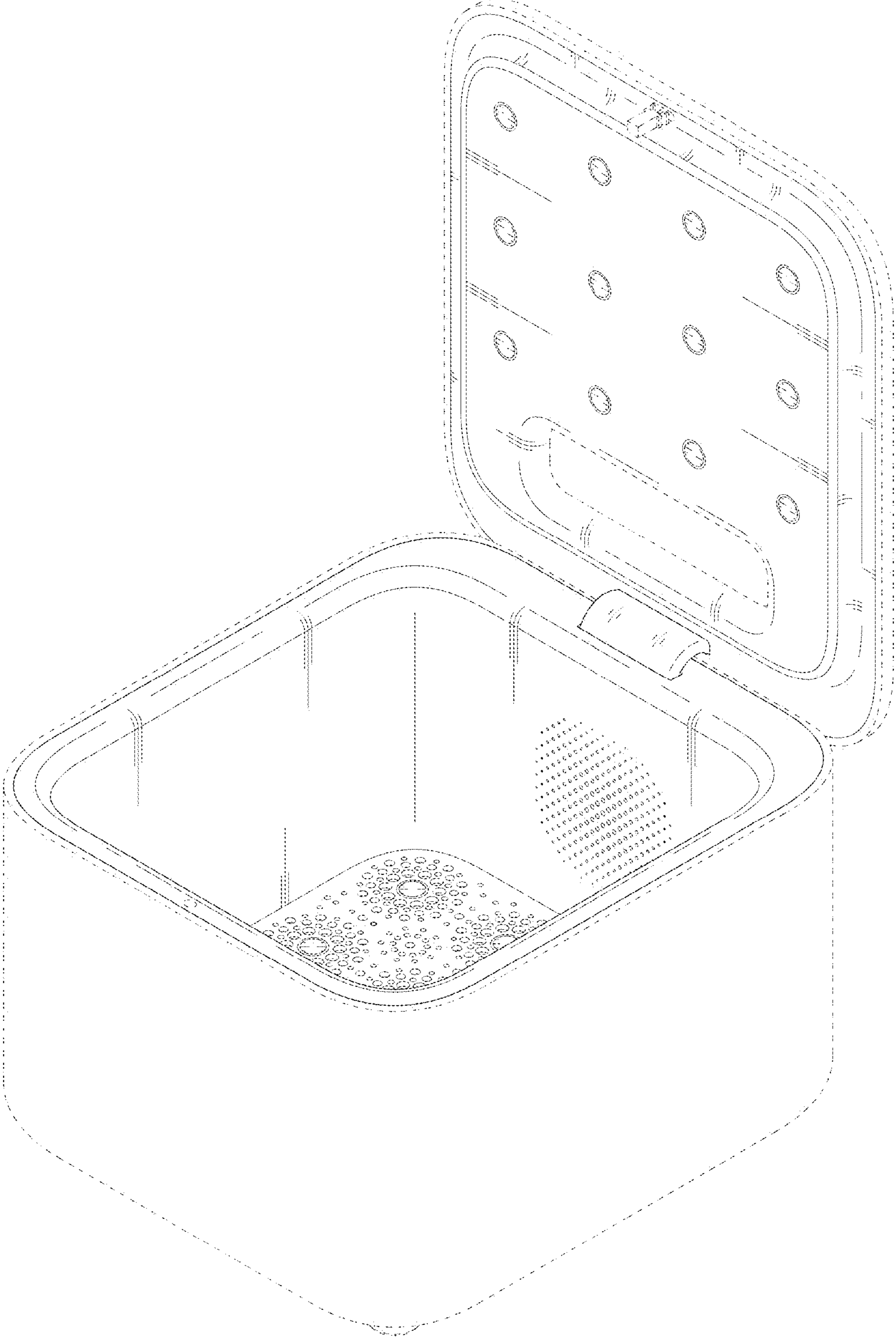

FIG. 2

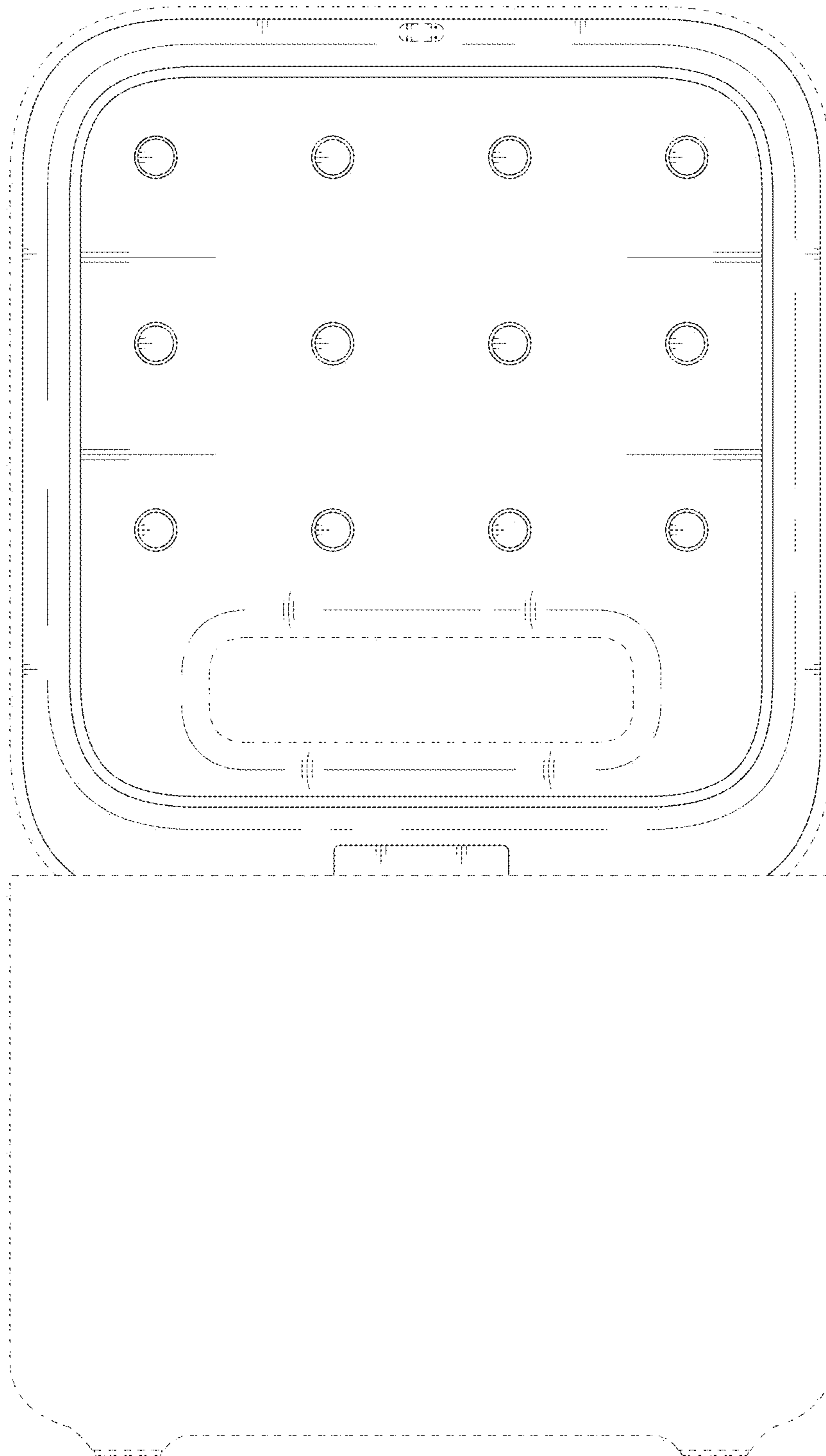

FIG. 3

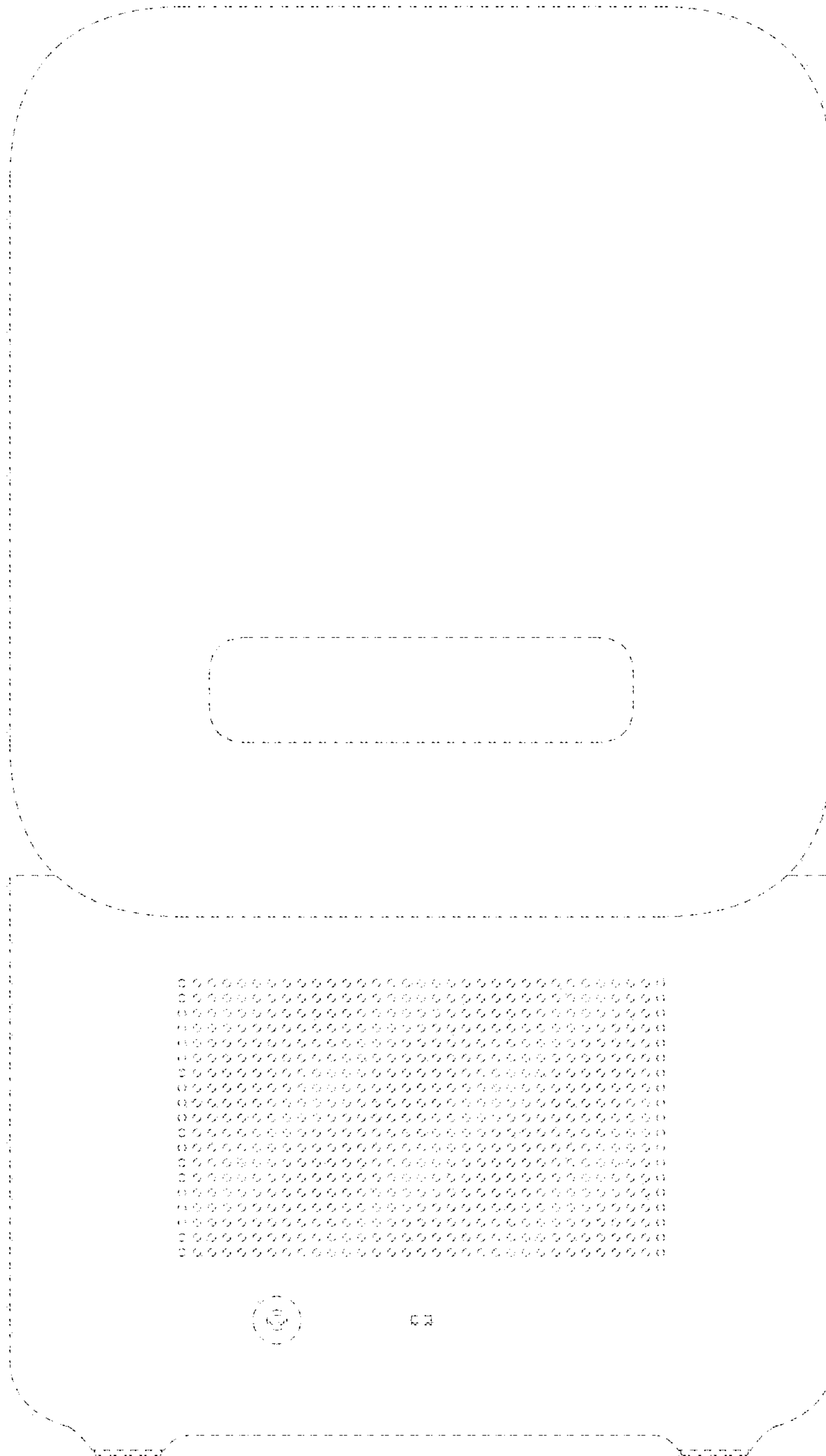

FIG. 4

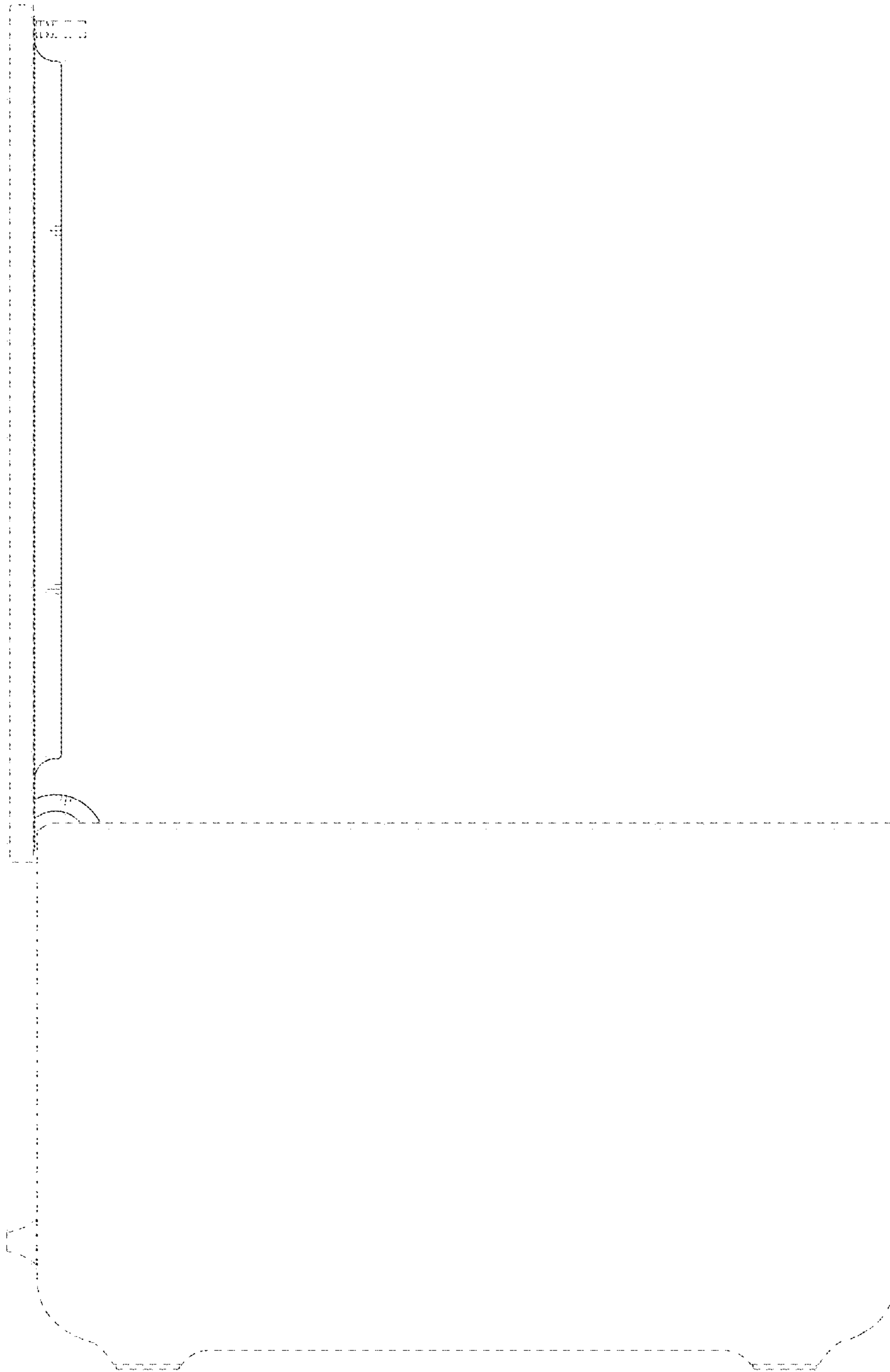

FIG. 5

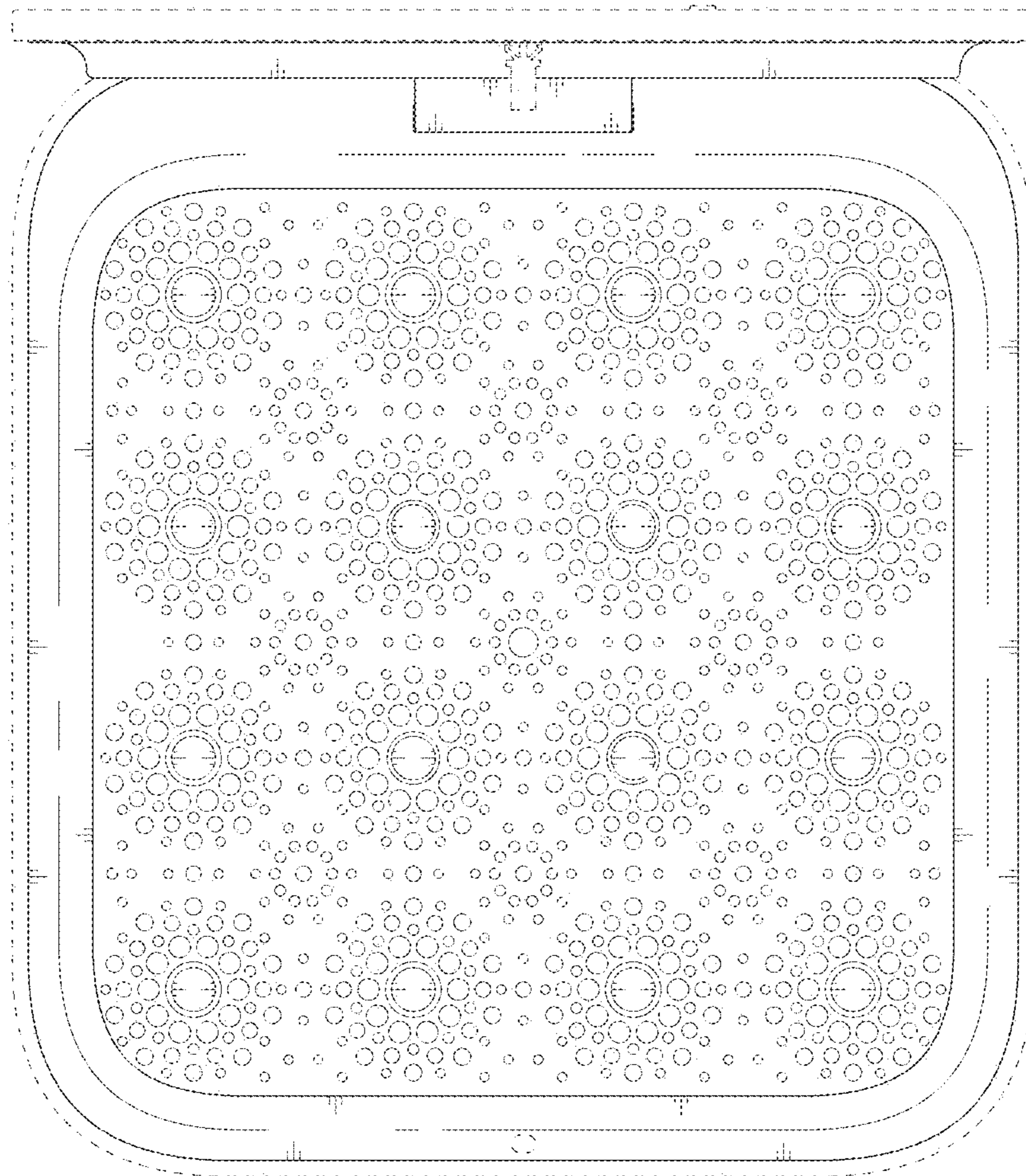

FIG. 6

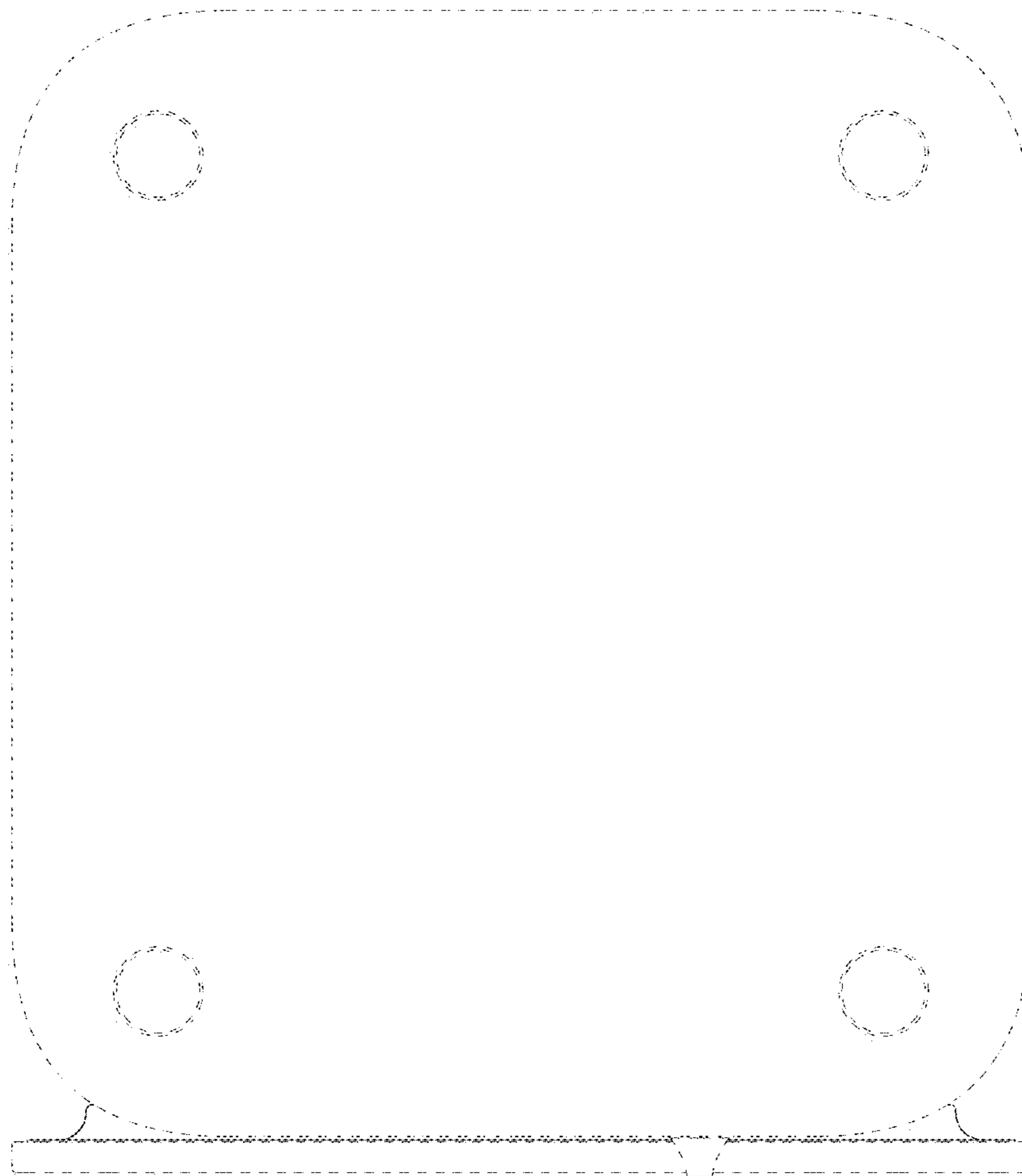

FIG. 7

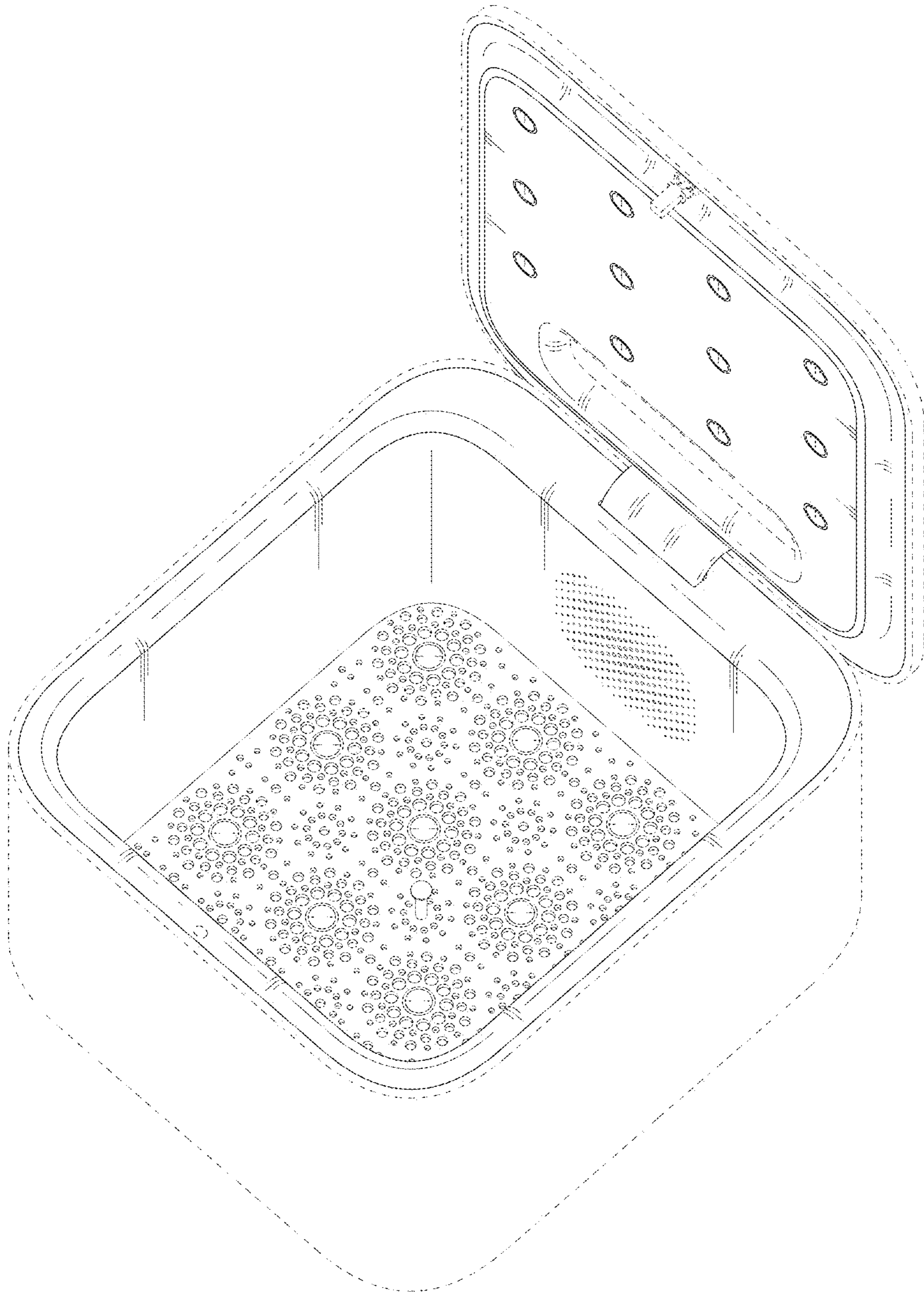

FIG. 8

