



US00D925049S

(12) **United States Design Patent**
Yang

(10) **Patent No.:** **US D925,049 S**

(45) **Date of Patent:** **** Jul. 13, 2021**

(54) **PHOTOTHERAPY LAMP**

(71) Applicant: **Dijin Yang**, Ganzhou (CN)

(72) Inventor: **Dijin Yang**, Ganzhou (CN)

(**) Term: **15 Years**

(21) Appl. No.: **29/743,114**

(22) Filed: **Jul. 19, 2020**

(51) **LOC (13) Cl.** **28-03**

(52) **U.S. Cl.**
USPC **D24/210**

(58) **Field of Classification Search**
USPC D24/107, 200, 209, 210, 214, 215, 185,
D24/186, 231; D26/37-39, 76, 104, 106,
D26/120; D28/9; D14/307, 336, 371,
D14/375, 376; D6/308, 310
CPC A61N 5/062; A61N 5/0614; A61N 5/0616;
A61N 5/0617; A61N 5/0618; A61N
5/0624; A61N 5/0627; A61N 5/0625;
A61N 2005/0643; A61N 2005/0644;
A61N 2005/0645; A61N 2005/0647;
A61N 2005/0651; A61N 2005/0652;
A61N 2005/0654; A61N 2005/0662;
A61B 2018/00452; A61B 2018/1807

See application file for complete search history.

(56) **References Cited**

U.S. PATENT DOCUMENTS

D599,485 S * 9/2009 Burrows D24/209
D736,942 S * 8/2015 Hagenauer D24/210
D807,522 S * 1/2018 Berke D24/210
D875,265 S * 2/2020 Li D24/210
D879,984 S * 3/2020 Hu D24/209
D893,039 S * 8/2020 Harmon D24/209

D903,135 S * 11/2020 Xiao D24/210
D903,136 S * 11/2020 Xiao D24/210
D905,445 S * 12/2020 Yang D6/310
D911,540 S * 2/2021 Li D24/210
D912,837 S * 3/2021 Zhang D24/210
2007/0129777 A1* 6/2007 Bolta A61N 5/0618
607/88
2021/0008387 A1* 1/2021 Jou A61N 5/0618

OTHER PUBLICATIONS

Amazon.com: Light Therapy Lamp,Ailikiwe UV-Free 10000 Lux
Brightness, Timer Function Sun lamp, Touch Control with 5 Adjust-
able Brightness Levels, Warm White and Cool White Two Color
temperatures. Date product available: Jan. 4, 2021. Retrieved from
website at: https://www.amazon.com/dp/B08RYH1B/ref=ssp.*

* cited by examiner

Primary Examiner — Anhdao Doan

(57) **CLAIM**

The ornamental design for a phototherapy lamp, as shown
and described.

DESCRIPTION

FIG. 1 is a front perspective view of the phototherapy lamp
showing my new design;
FIG. 2 is a rear, bottom perspective view thereof;
FIG. 3 is a front elevational view thereof;
FIG. 4 is a rear elevational view thereof;
FIG. 5 is a left side elevational view thereof;
FIG. 6 is a right side elevational view thereof;
FIG. 7 is a top plan view thereof; and,
FIG. 8 is a bottom plan view thereof.

1 Claim, 7 Drawing Sheets

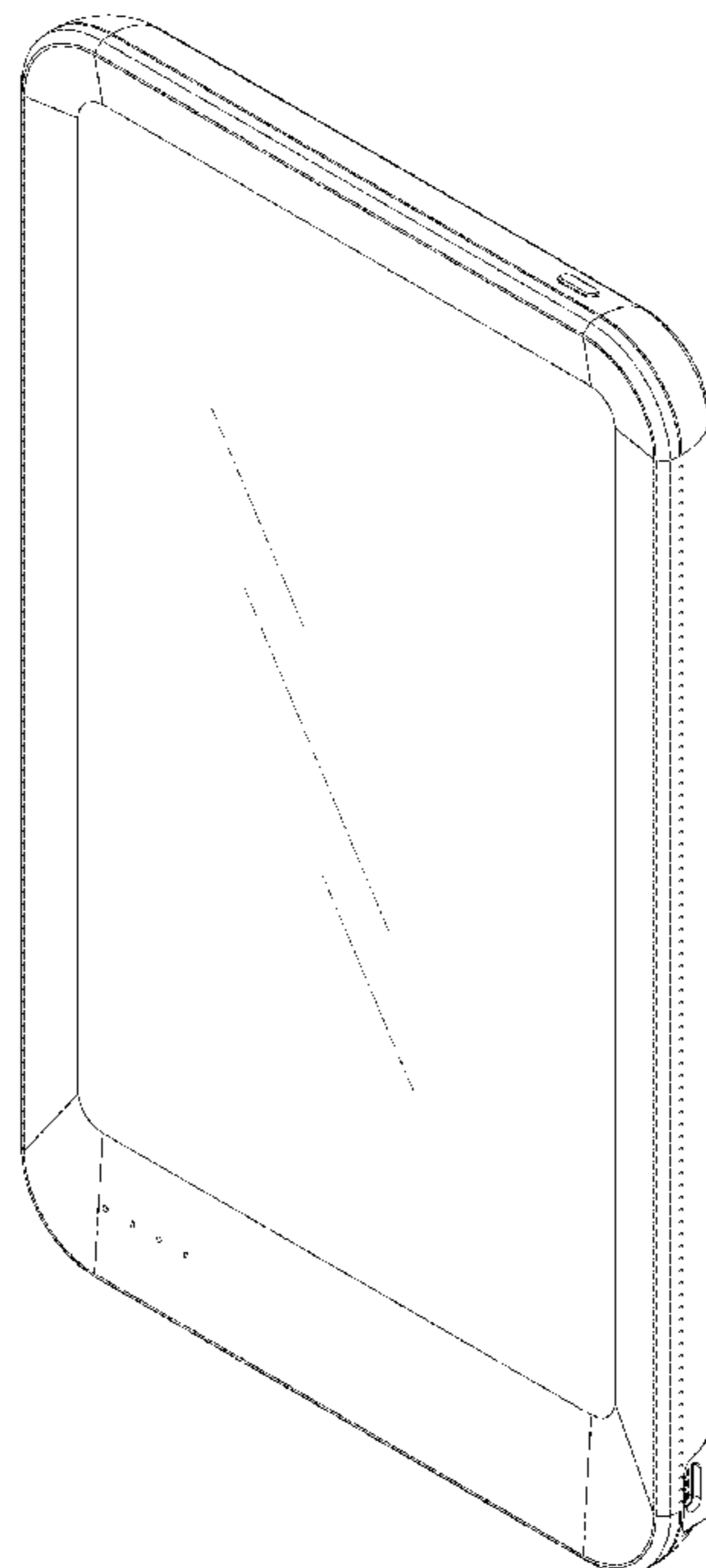

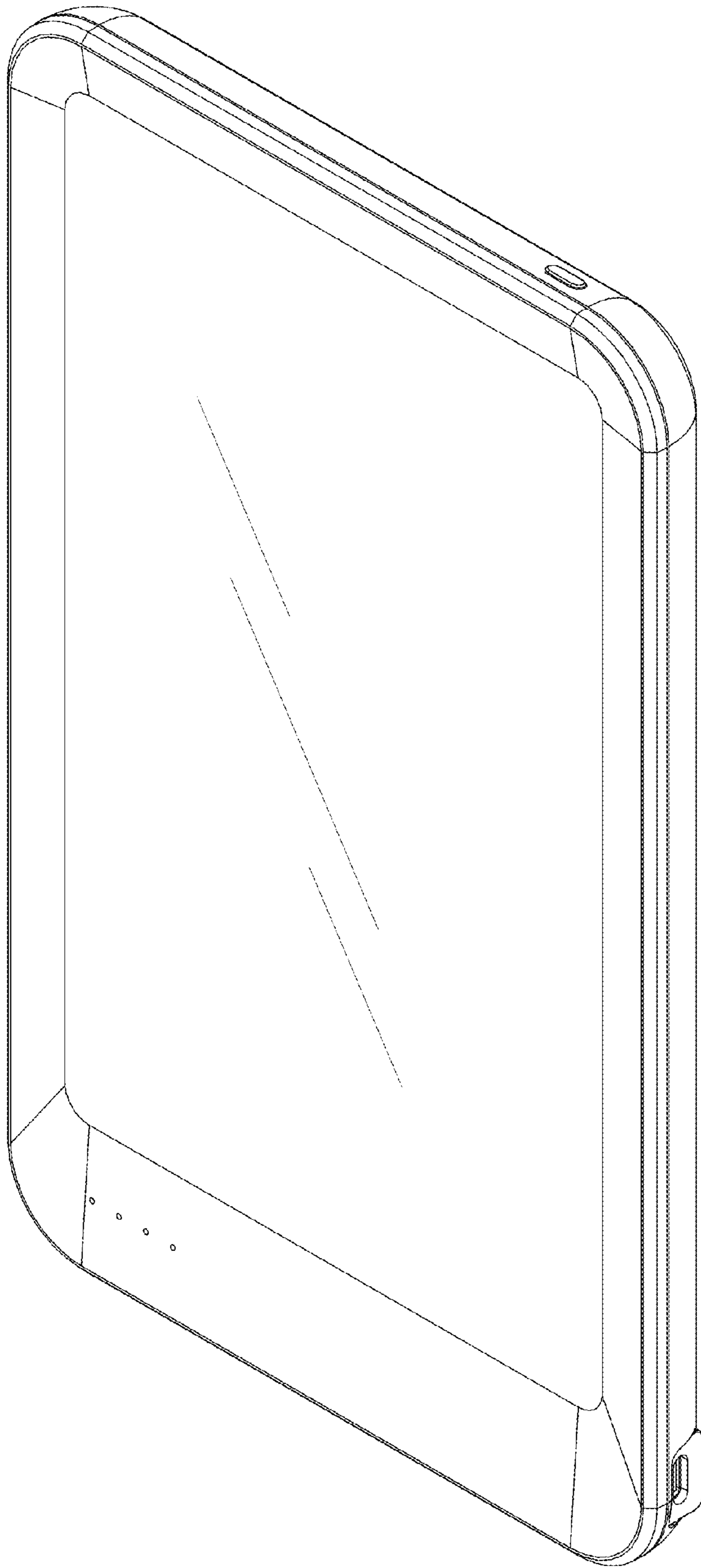

FIG. 1

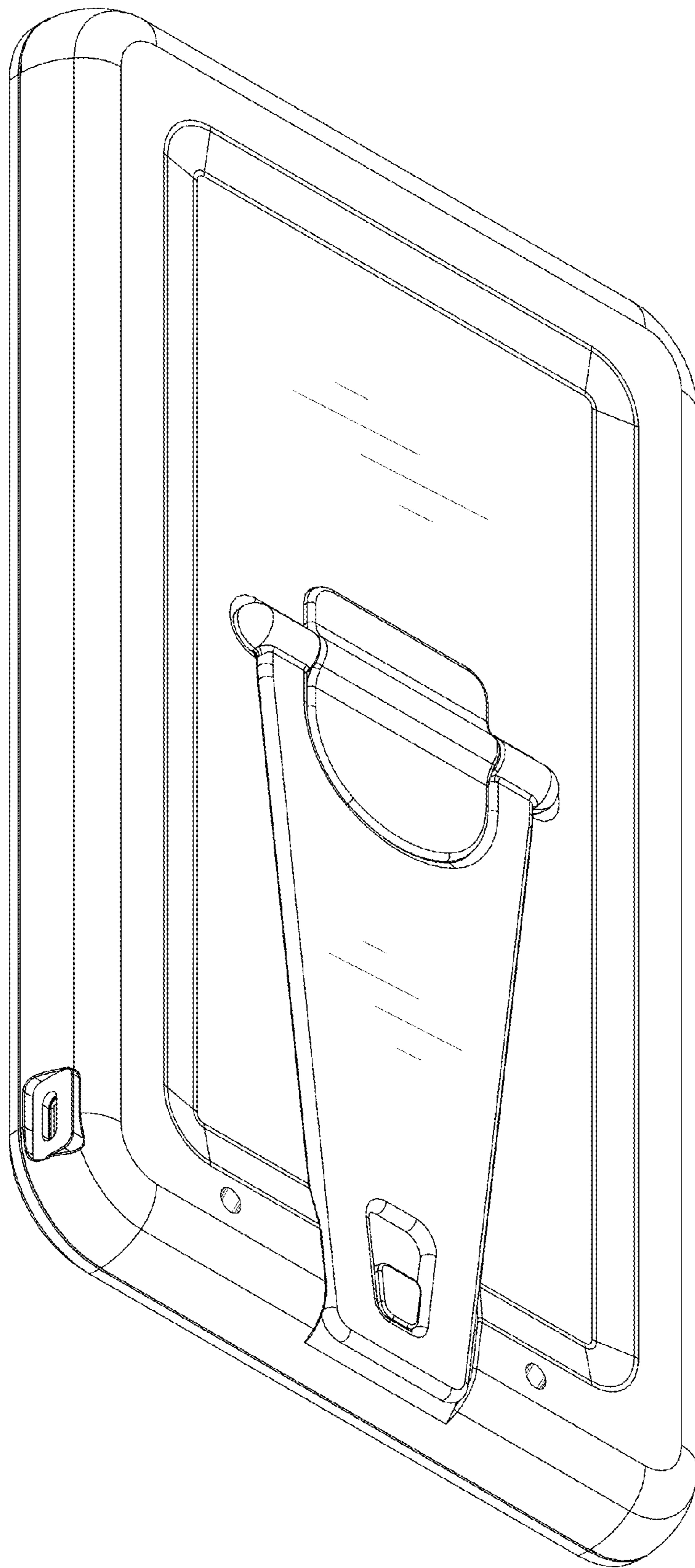

FIG. 2

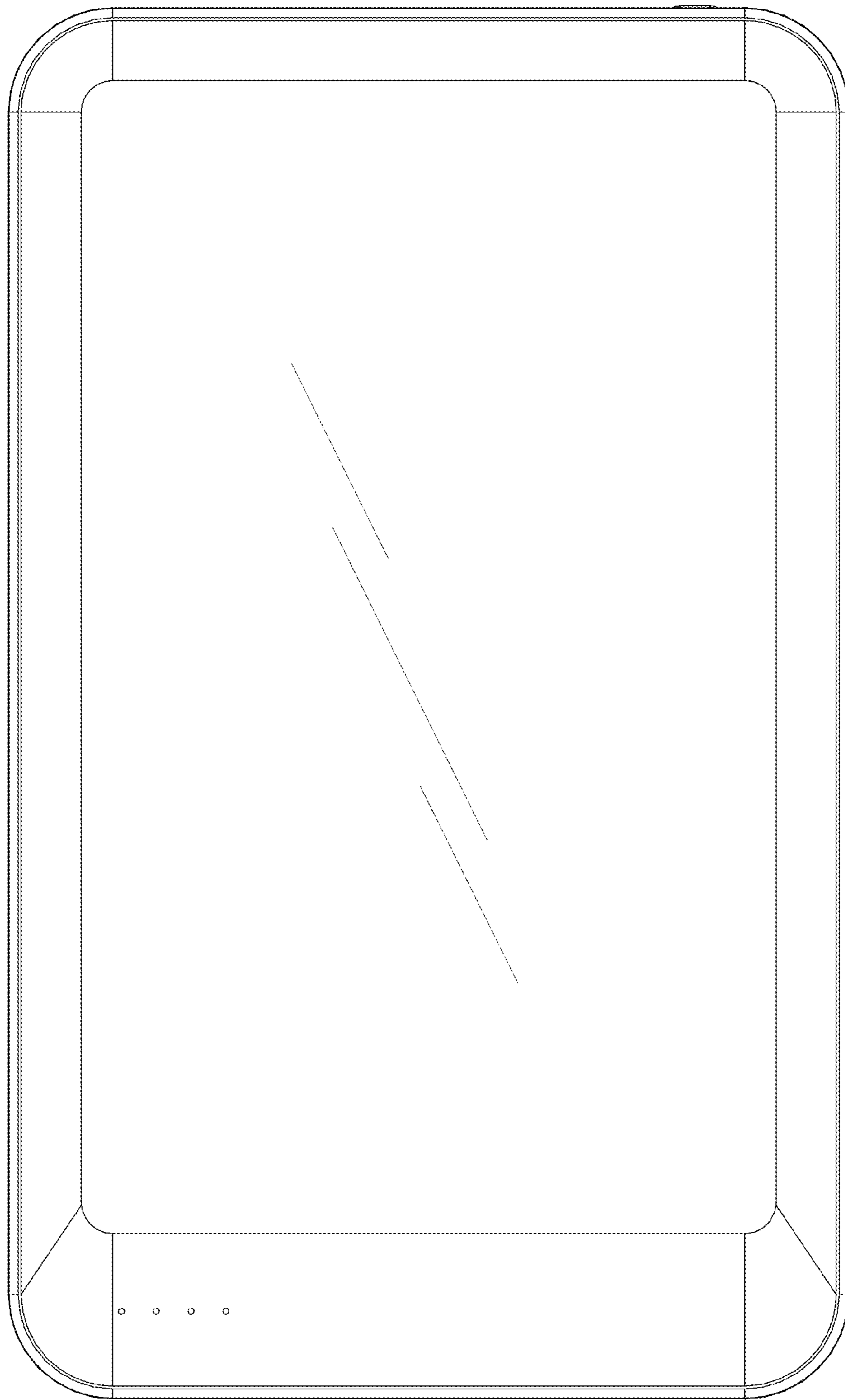

FIG. 3

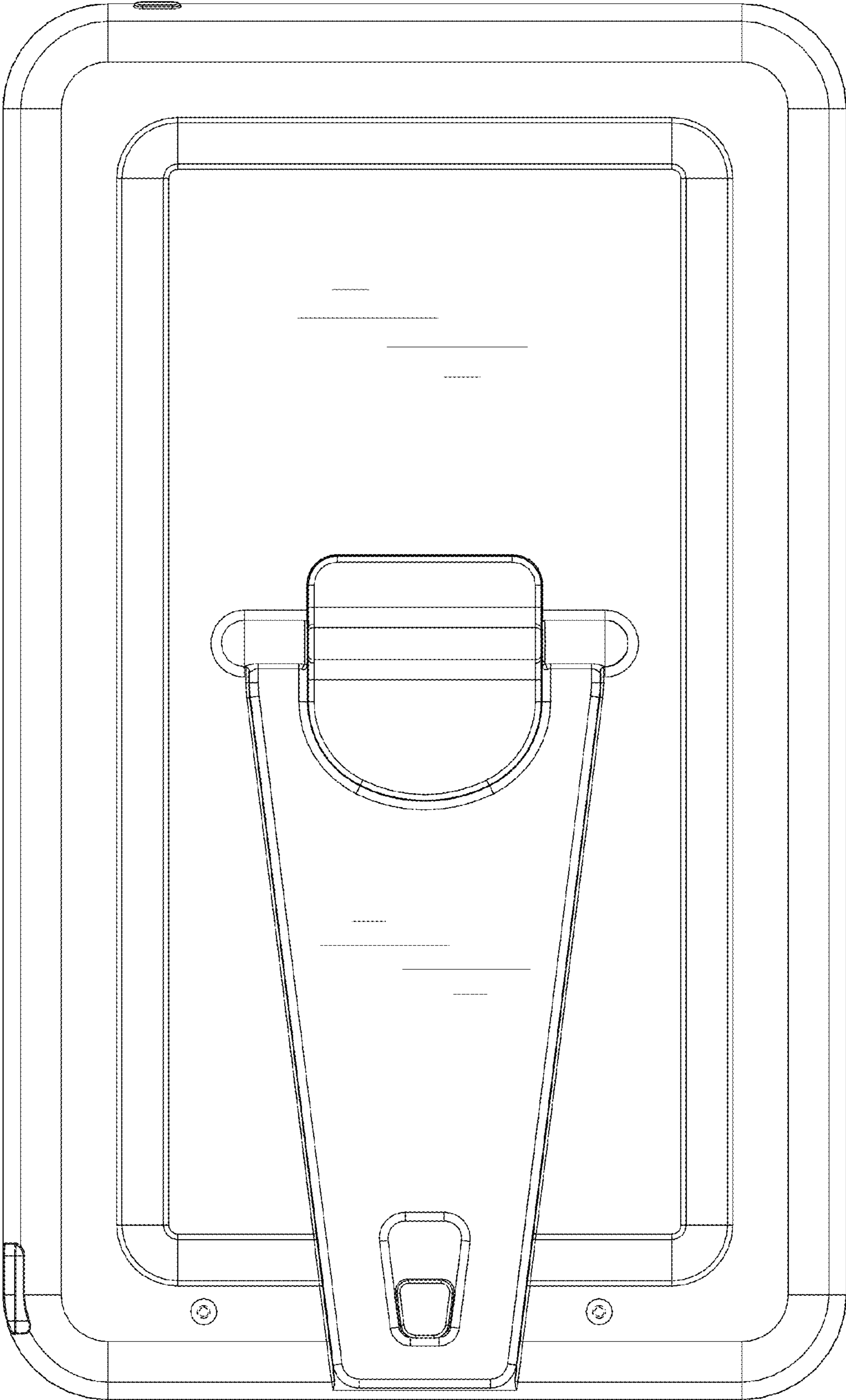

FIG. 4

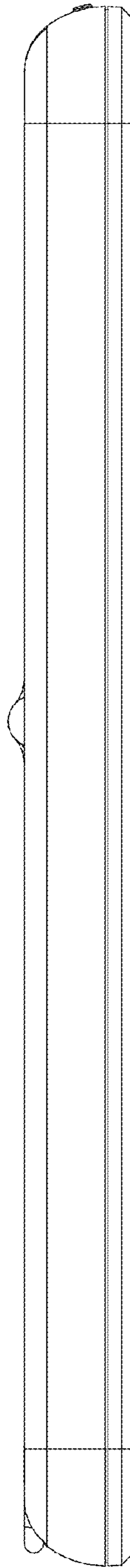

FIG. 5

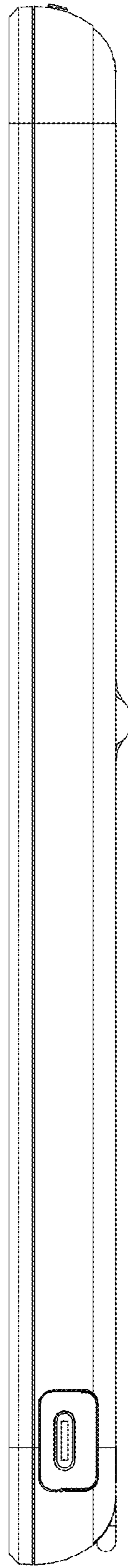

FIG. 6

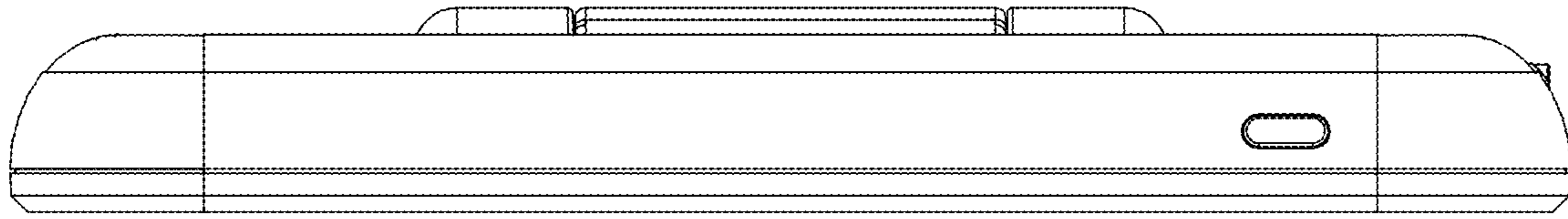

FIG. 7

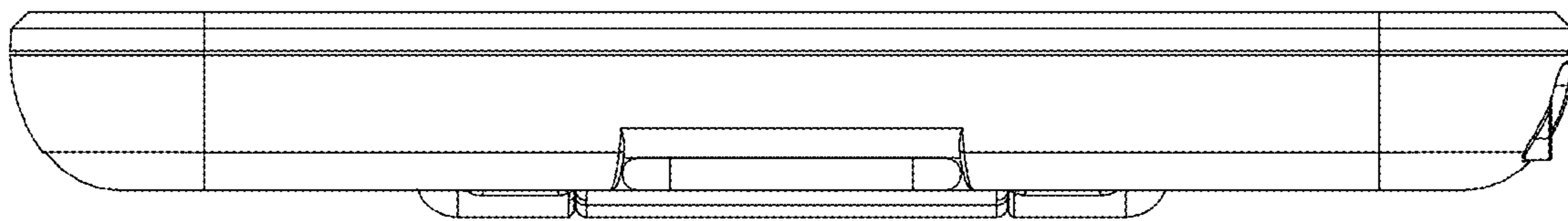

FIG. 8