



US00D924972S

(12) **United States Design Patent**  
**Elmer**

(10) **Patent No.:** **US D924,972 S**  
(45) **Date of Patent:** **\*\* Jul. 13, 2021**

(54) **VEHICLE-MOUNTED SIGN**

(71) Applicant: **Steven W. Elmer**, Winter Park, FL  
(US)

(72) Inventor: **Steven W. Elmer**, Winter Park, FL  
(US)

(\*\*) Term: **15 Years**

(21) Appl. No.: **29/753,704**

(22) Filed: **Oct. 1, 2020**

**Related U.S. Application Data**

(62) Division of application No. 29/676,940, filed on Jan. 16, 2019, now Pat. No. Des. 901,588.

(51) **LOC (13) Cl.** ..... **20-03**

(52) **U.S. Cl.**  
USPC ..... **D20/10**

(58) **Field of Classification Search**  
USPC ..... D14/125, 126, 127, 250, 257, 336, 371,  
D14/374, 432; D20/10, 13, 17, 19, 29,  
D20/38, 39, 41, 42, 43, 99; D13/102  
CPC ..... G09F 7/00; G09F 7/02; G09F 7/16; G09F  
9/00; G09F 9/3026; G09F 9/33; G09F  
9/35; G09F 13/00; G09F 13/22; G09F  
15/00; G09F 15/0056; G09F 15/0068;  
G06F 3/14; H01R 13/514

See application file for complete search history.

(56) **References Cited**

**U.S. PATENT DOCUMENTS**

D327,333 S \* 6/1992 Elmer ..... D20/10  
D328,143 S \* 7/1992 Elmer ..... D20/10  
D359,515 S \* 6/1995 Kinart ..... D20/42  
D368,934 S \* 4/1996 Elmer ..... D20/42  
D425,812 S \* 5/2000 Bodo ..... D10/113.4  
6,056,425 A \* 5/2000 Appelberg ..... B60Q 1/2611  
362/493  
D429,766 S \* 8/2000 Elmer ..... D20/10

D496,966 S \* 10/2004 Ulrich ..... D20/42  
D552,633 S \* 10/2007 Volkan ..... D11/157  
D567,876 S \* 4/2008 Au ..... D20/10  
D617,384 S \* 6/2010 Elmer ..... D20/10  
D641,900 S \* 7/2011 Iqbal ..... D26/31  
D654,540 S \* 2/2012 Zarelius ..... D20/43  
D655,348 S \* 3/2012 Cooper ..... D20/43  
D657,421 S \* 4/2012 Yan ..... D20/10  
D657,422 S \* 4/2012 Yan ..... D20/10  
RE44,480 E \* 9/2013 Elmer ..... G09F 21/042  
40/592  
D740,407 S \* 10/2015 Kassouni ..... D24/101  
D831,116 S \* 10/2018 Banas ..... D20/10  
D841,236 S \* 2/2019 Zuckerman ..... D28/8.1  
D846,830 S \* 4/2019 Kamakura ..... D1/127  
D862,836 S \* 10/2019 Bauer ..... D1/127  
D901,587 S \* 11/2020 Elmer ..... D20/10  
D901,588 S \* 11/2020 Elmer ..... D20/10  
D901,589 S \* 11/2020 Elmer ..... D20/10

(Continued)

*Primary Examiner* — Mary Ann Calabrese

*Assistant Examiner* — Catherine Ho

(74) *Attorney, Agent, or Firm* — Allen Dyer Doppelt & Gilchrist, PA

(57) **CLAIM**

The ornamental design for a vehicle-mounted sign, as shown.

**DESCRIPTION**

FIG. 1 is a top, left, front perspective view of a vehicle-mounted sign, showing my new design;  
FIG. 2 is a bottom, right, rear perspective view thereof;  
FIG. 3 is a top view thereof;  
FIG. 4 is a bottom view thereof;  
FIG. 5 is a front view thereof;  
FIG. 6 is a rear view thereof;  
FIG. 7 is a left side view thereof; and,  
FIG. 8 is a right side view thereof.

**1 Claim, 8 Drawing Sheets**

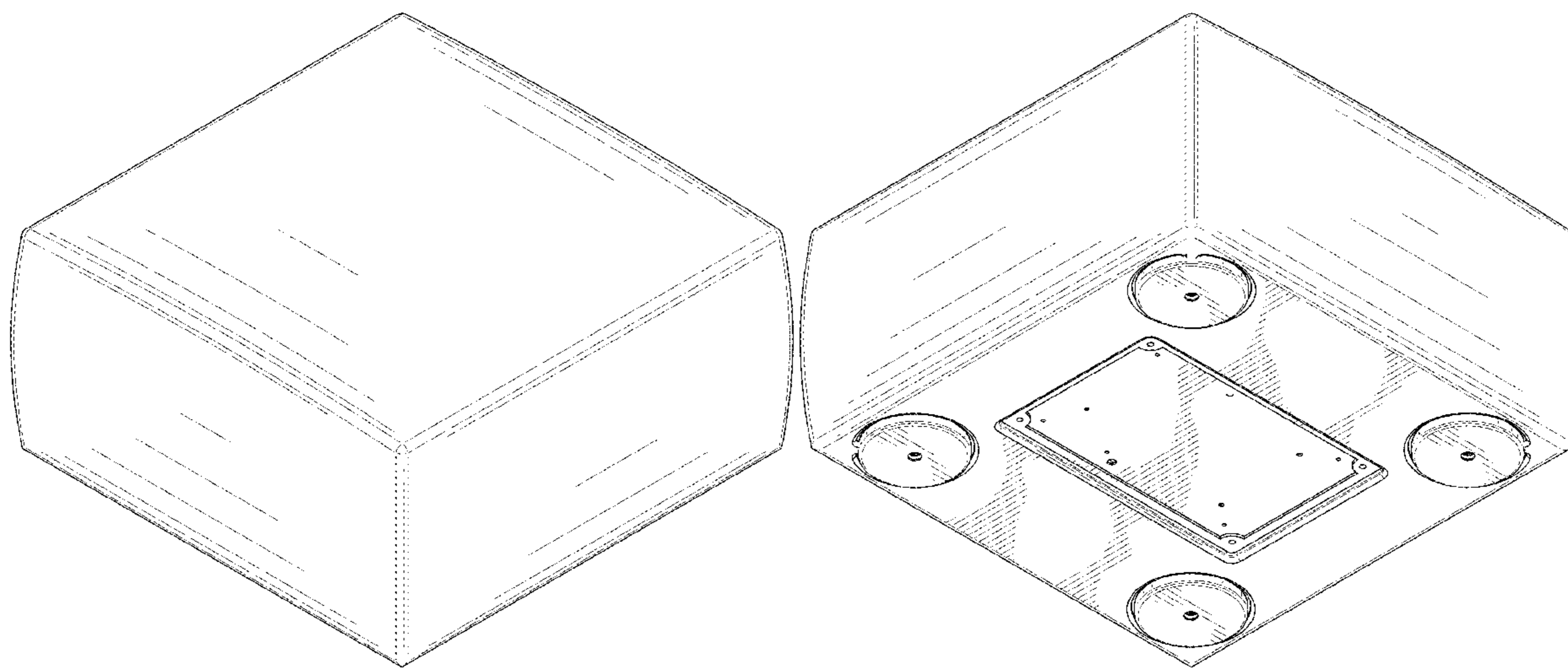

(56)

**References Cited**

U.S. PATENT DOCUMENTS

D901,590 S \* 11/2020 Elmer ..... D20/10  
D901,591 S \* 11/2020 Elmer ..... D20/10  
D901,592 S \* 11/2020 Elmer ..... D20/10

\* cited by examiner

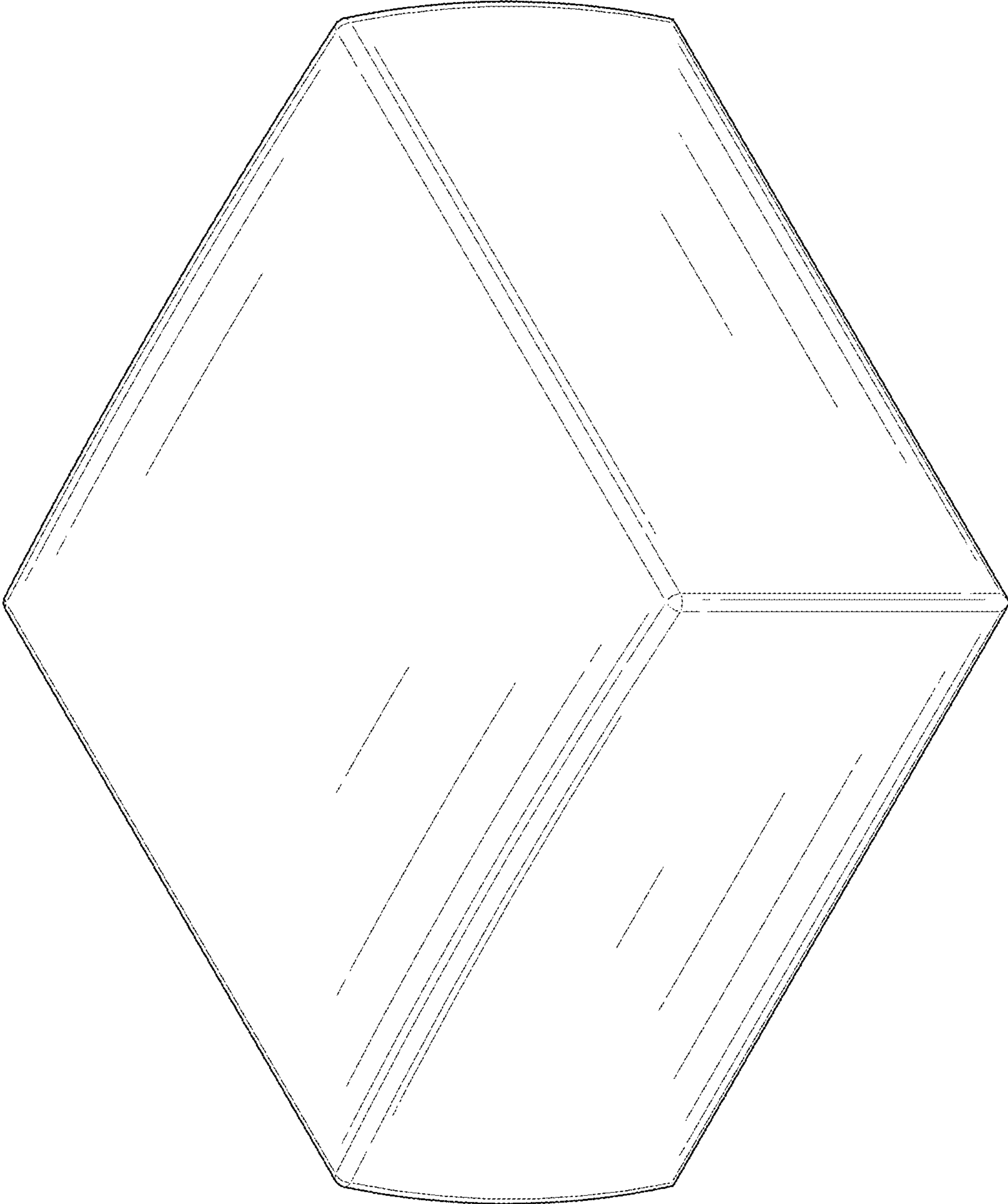

FIG. 1

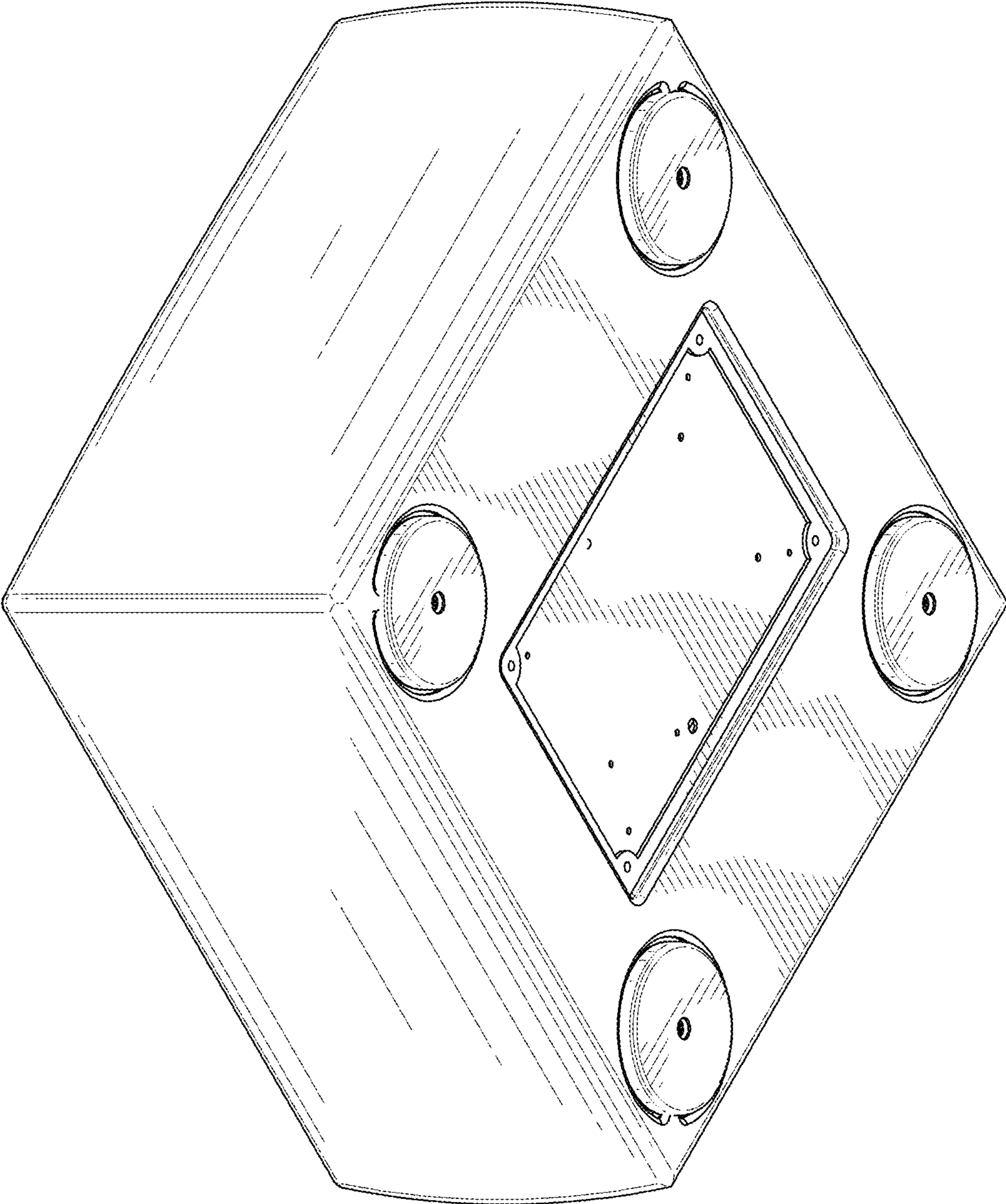

FIG. 2

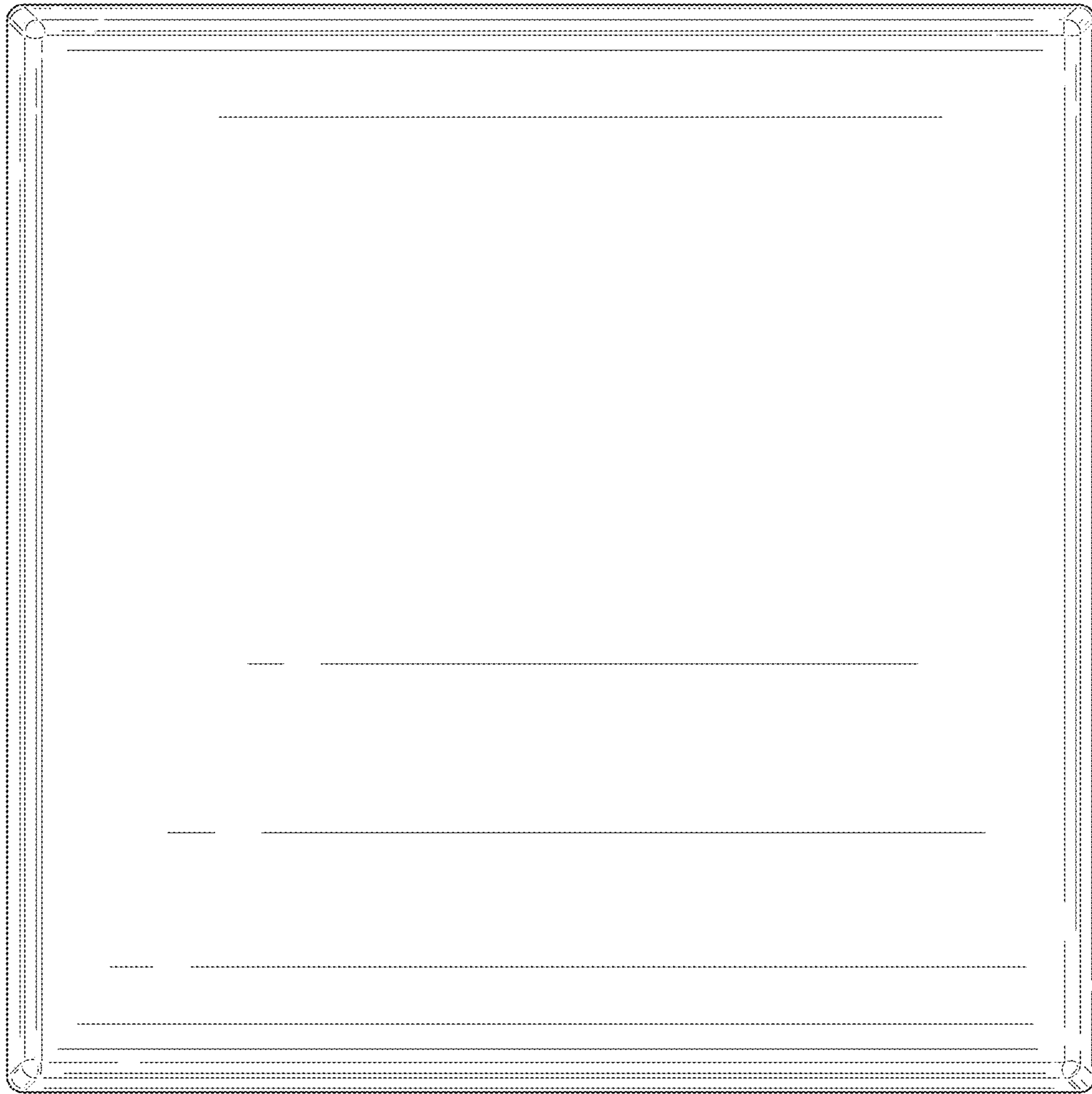

FIG. 3

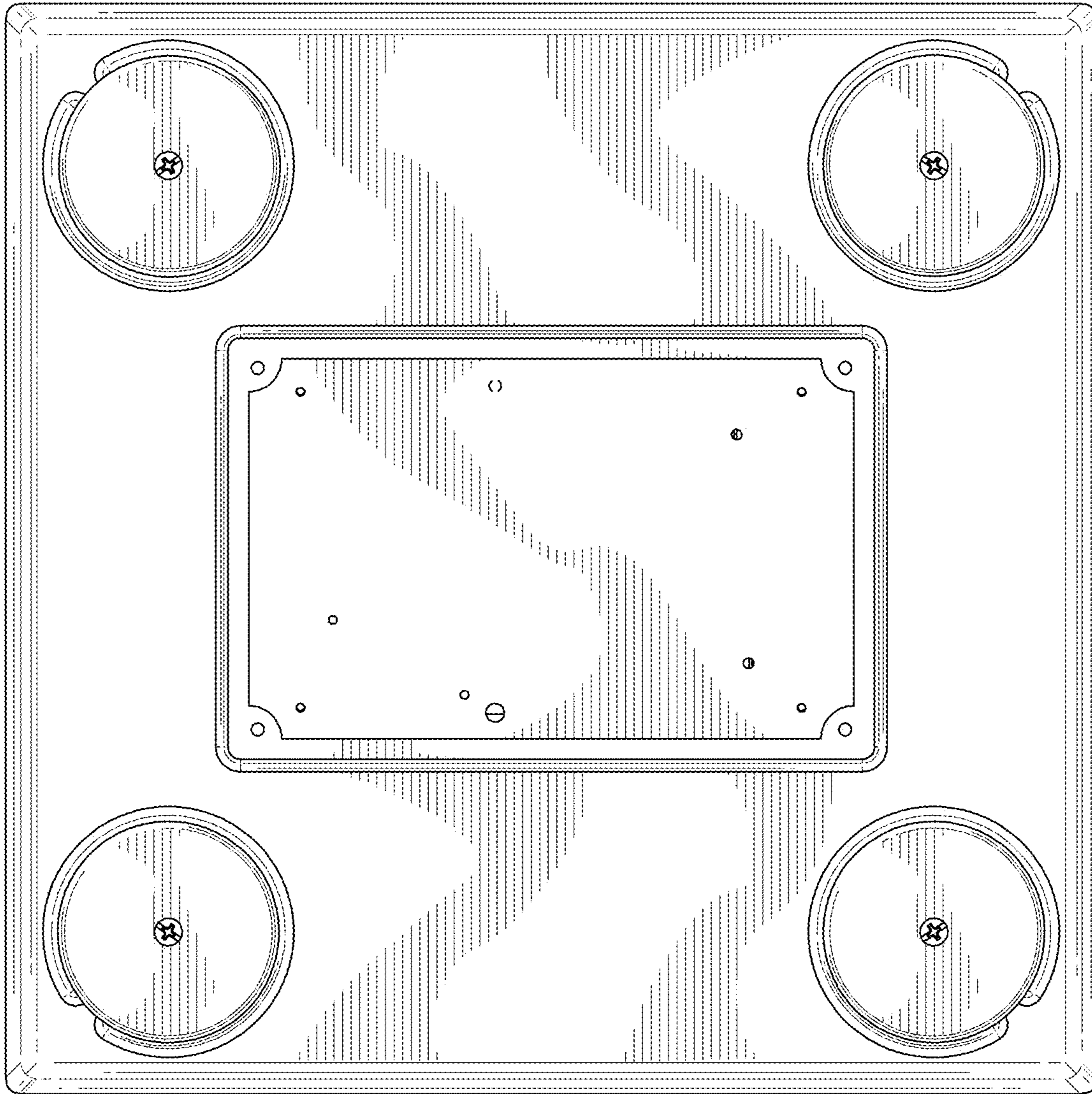

FIG. 4

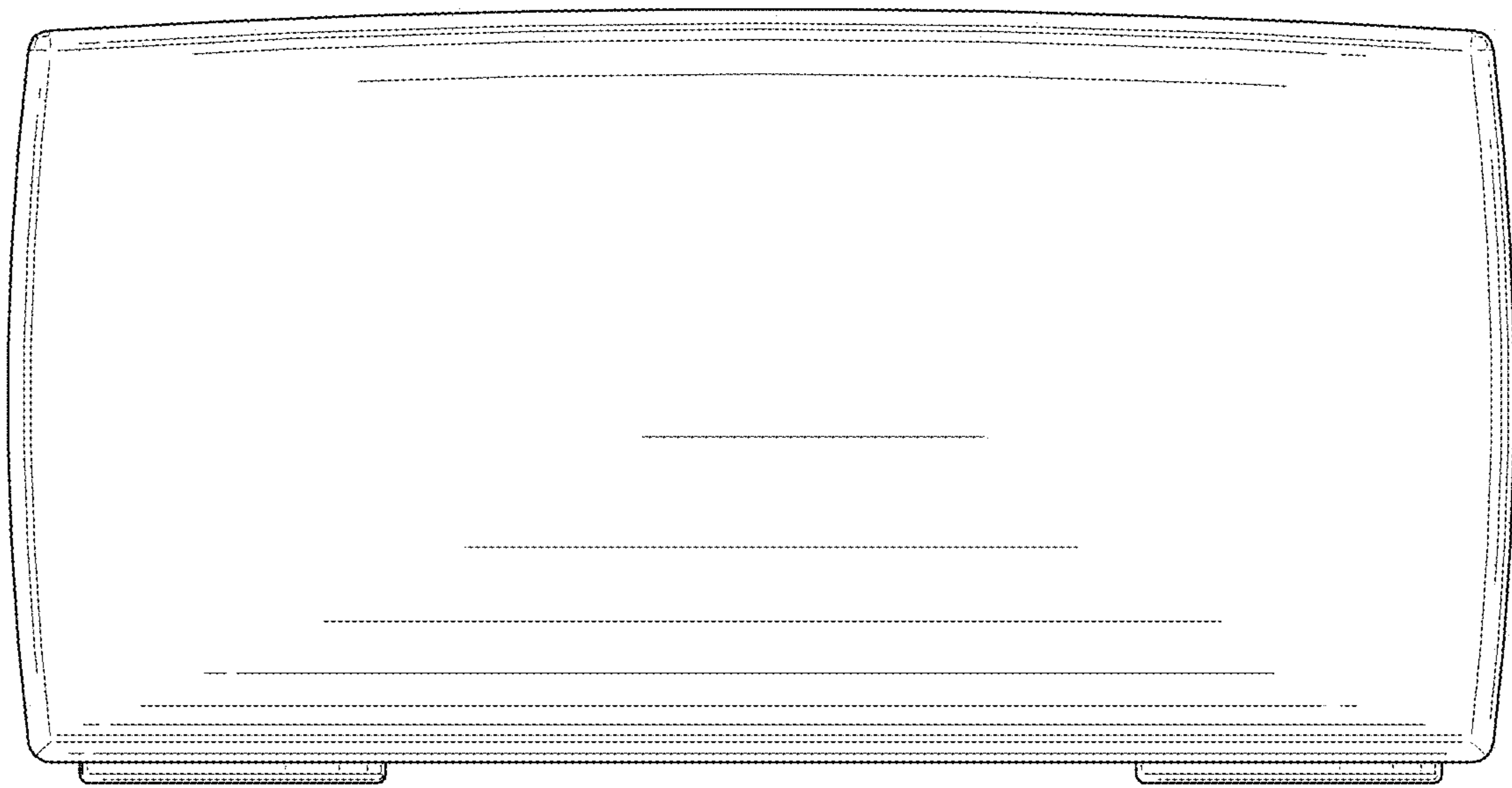

FIG. 5

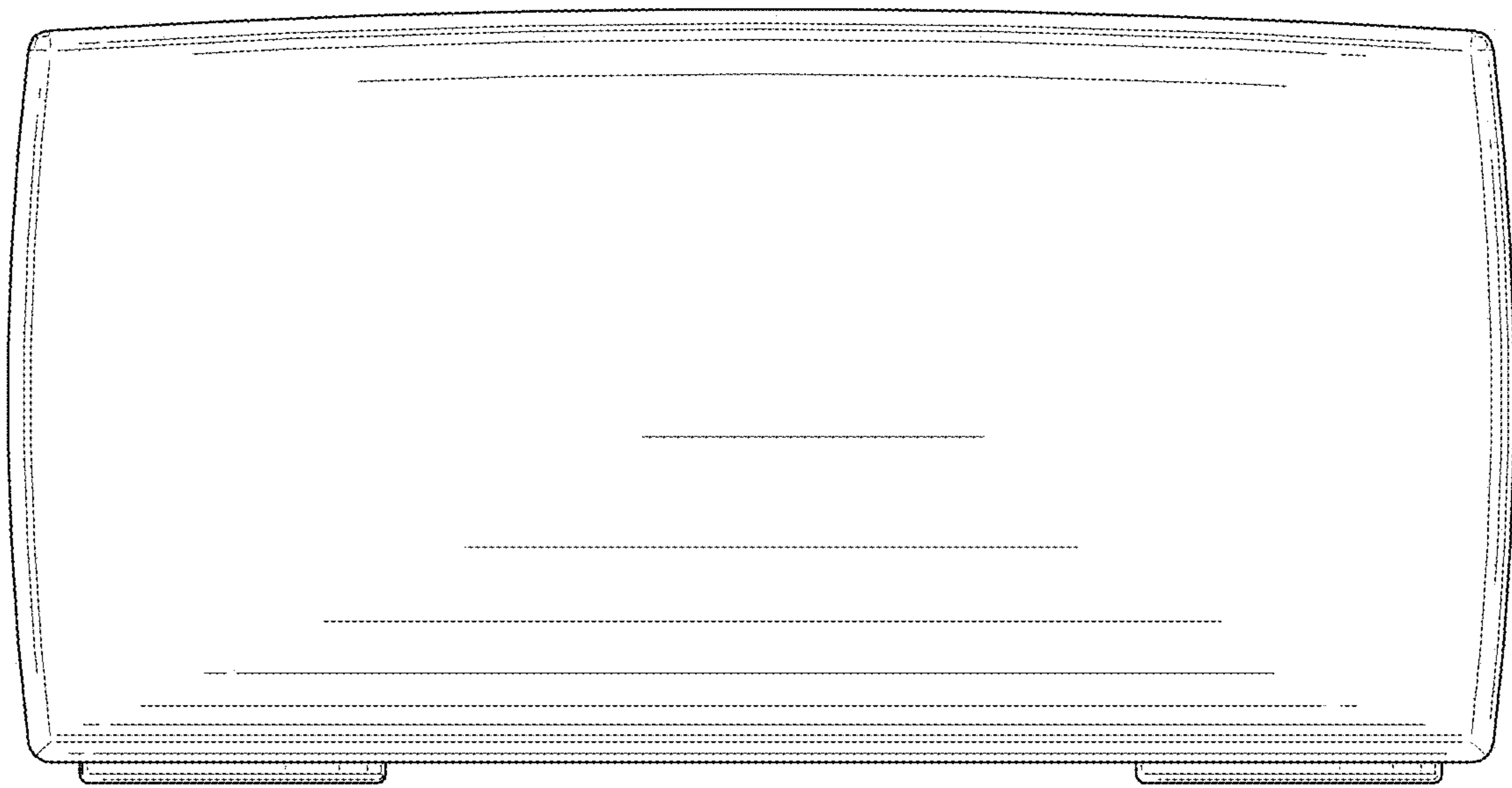

FIG. 6



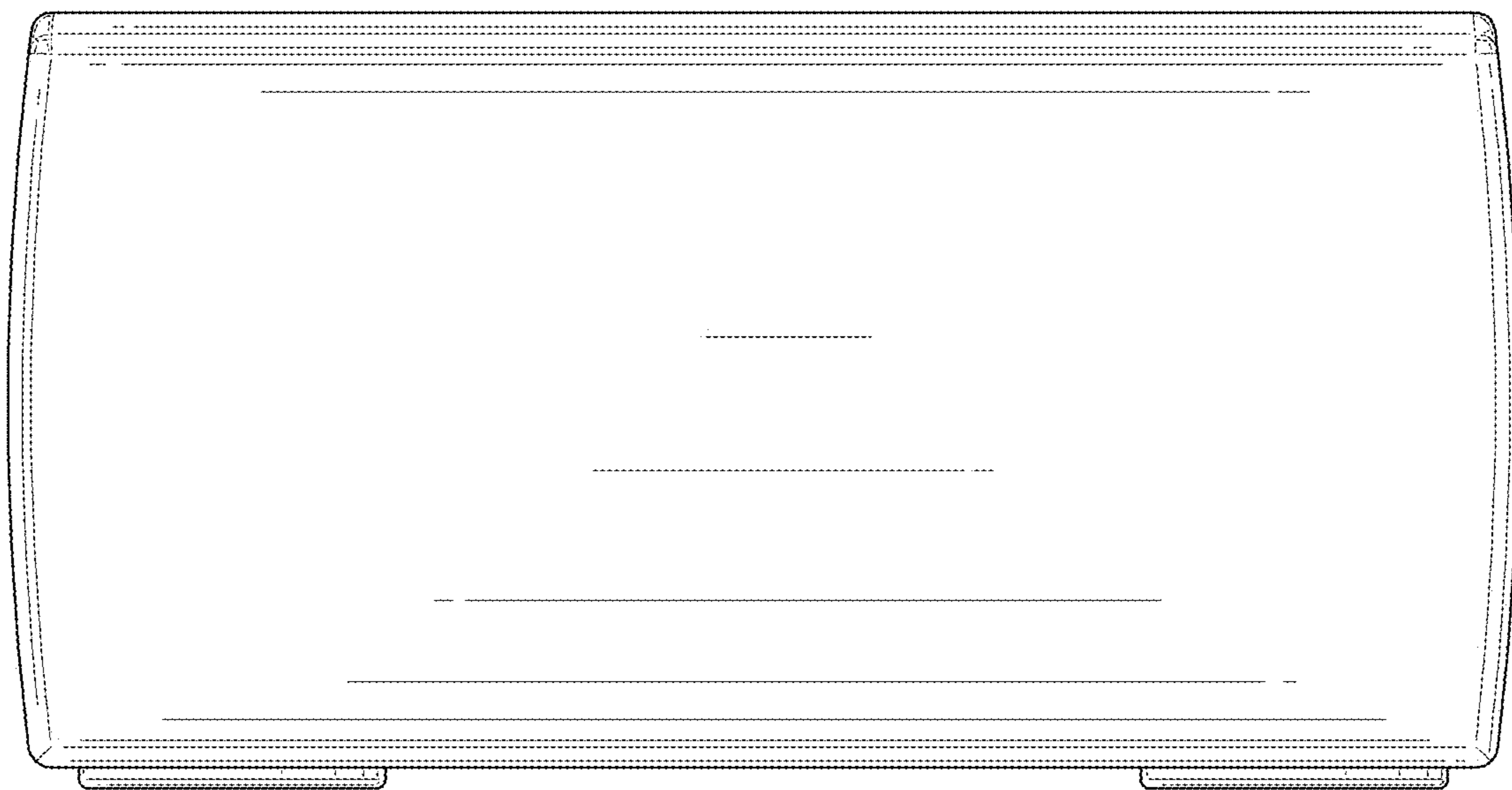

FIG. 7

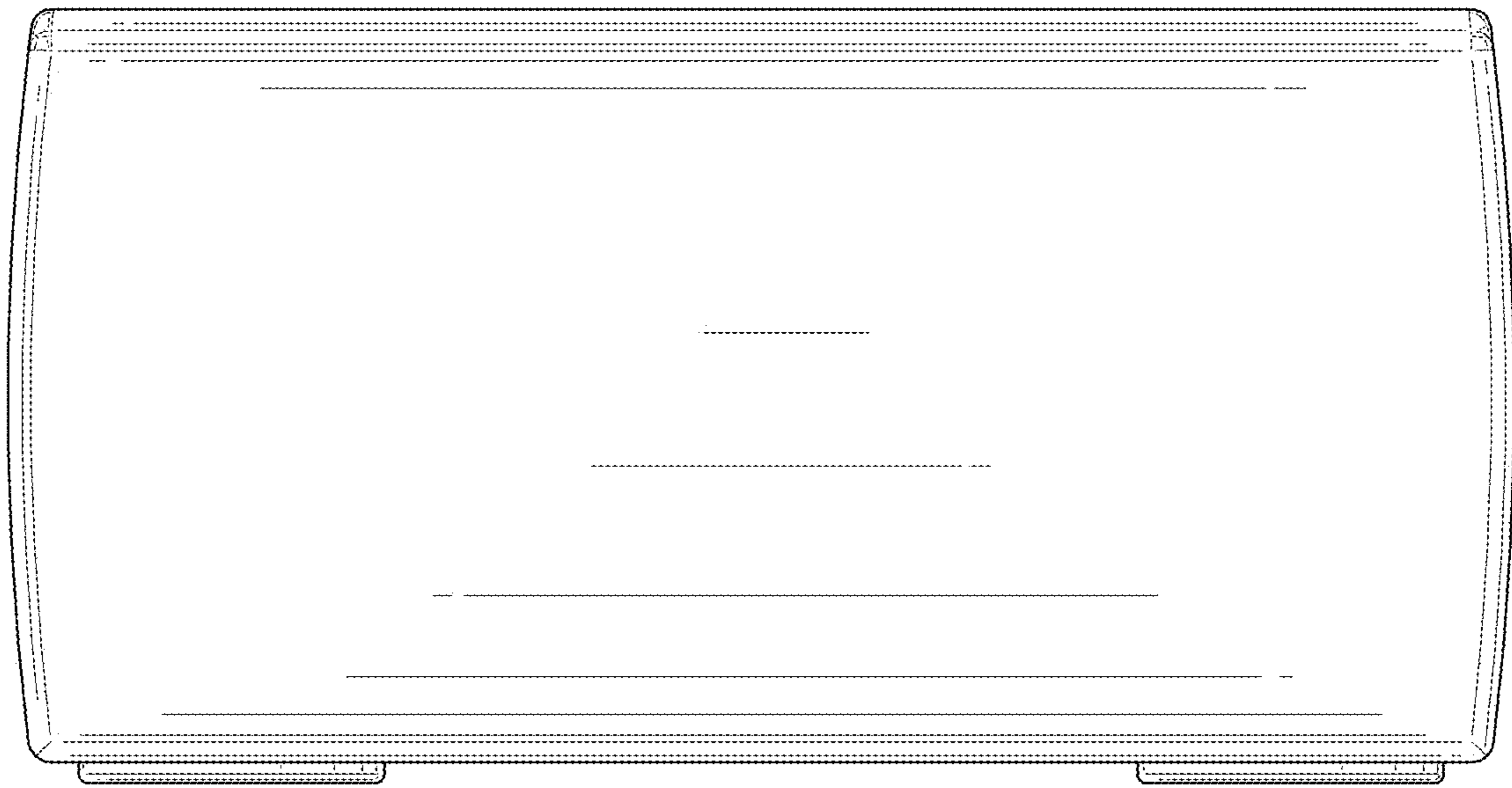

FIG. 8