



US00D924754S

(12) **United States Design Patent** (10) **Patent No.:** **US D924,754 S**  
**Duncan et al.** (45) **Date of Patent:** **\*\* Jul. 13, 2021**

(54) **TOP PANEL FOR A TRUCK HOOD**

(71) Applicant: **PACCAR Inc**, Bellevue, WA (US)

(72) Inventors: **Jonathan Scott Duncan**, Seattle, WA (US); **Zachary Steven Gross**, Flower Mound, TX (US); **Amanda Allison Koh**, Seattle, WA (US); **Steven H. Hovind**, Renton, WA (US); **Louis Daniel Heilaneh**, Lewisville, TX (US); **Derek Scott Sancer**, Denton, TX (US)

(73) Assignee: **PACCAR Inc**, Bellevue, WA (US)

(\*\*) Term: **15 Years**

(21) Appl. No.: **29/721,185**

(22) Filed: **Jan. 17, 2020**

(51) **LOC (13) Cl.** ..... **12-08**

(52) **U.S. Cl.**  
USPC ..... **D12/173**

(58) **Field of Classification Search**  
USPC .... D12/86, 91, 93, 163, 164, 165, 166, 167, D12/169, 171, 172, 173, 181, 183, 190, D12/196, 216  
CPC .. B60R 1/06; B60R 9/06; B60R 19/02; B60R 19/04; B60R 19/18; B60R 19/44; B60R 19/48; B62D 25/10; B62D 25/16; B62D 25/168; B62D 35/02; B62D 39/00; B62D 65/16; B62D 21/12; B29C 45/16  
See application file for complete search history.

(56) **References Cited**

**U.S. PATENT DOCUMENTS**

D366,638 S	1/1996	Tucker et al.
D382,841 S	8/1997	Norwood et al.
D395,860 S	7/1998	Meryman et al.
D403,636 S	1/1999	Meryman et al.
D411,494 S	6/1999	Meryman et al.
D422,251 S	4/2000	Bader et al.
D435,816 S	1/2001	Delashaw et al.
D436,563 S	1/2001	Delashaw et al.
D484,077 S	12/2003	Conway et al.

D497,581 S	10/2004	Conway et al.
D502,901 S	3/2005	Delashaw et al.
D531,947 S	11/2006	Angelo et al.
D532,350 S	11/2006	Angelo et al.
D532,352 S	11/2006	Angelo et al.
D540,725 S	4/2007	Gunter et al.
D545,250 S	6/2007	Angelo et al.
D545,251 S	6/2007	Angelo et al.
D545,254 S	6/2007	Angelo et al.
D560,575 S	1/2008	Simons et al.
D560,582 S	1/2008	Simons et al.
D560,583 S	1/2008	Simons et al.
D563,849 S	3/2008	Medina et al.

(Continued)

**OTHER PUBLICATIONS**

“T800,” Kenworth Truck Company, 2005, 28-page brochure.  
(Continued)

*Primary Examiner* — Brett Miller

*Assistant Examiner* — Suzanne E Tisdell

(74) *Attorney, Agent, or Firm* — Seed IP Law Group LLP

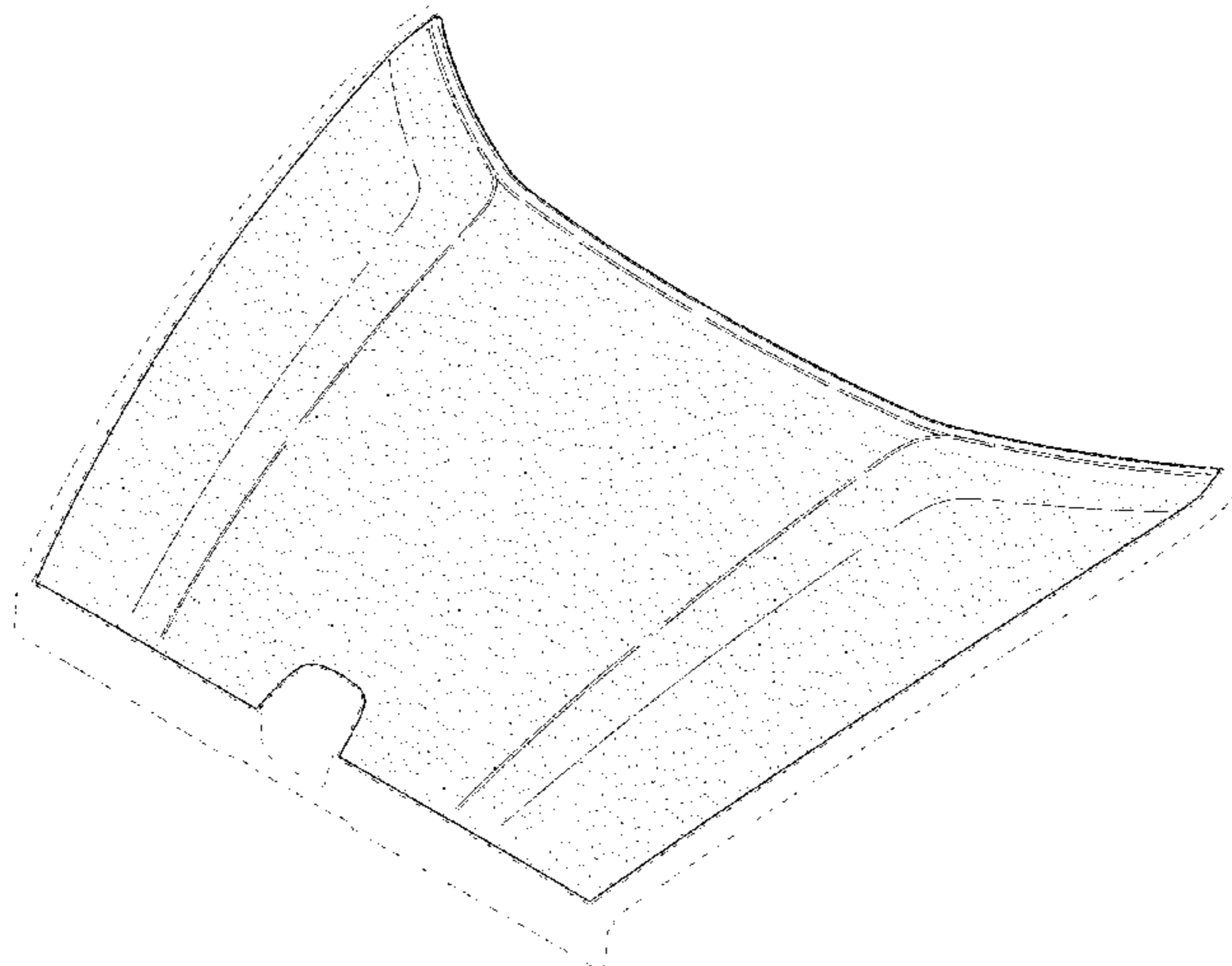
(57) **CLAIM**

The ornamental design for a top panel for a truck hood, as shown and described.

**DESCRIPTION**

FIG. 1 is a top isometric view of a top panel for a truck hood, showing our new design.  
FIG. 2 is a front elevational view thereof.  
FIG. 3 is a rear elevational view thereof.  
FIG. 4 is a left side elevational view thereof.  
FIG. 5 is a right side elevational view thereof.  
FIG. 6 is a top plan view thereof; and,  
FIG. 7 is a bottom plan view thereof.  
Stippling and tangency lines in the drawings represent the three-dimensional contours of the design, and are not intended to indicate surface decoration. The broken lines shown in the drawings depict portions of the top panel for a truck hood that form no part of the claimed design.

**1 Claim, 5 Drawing Sheets**





(56)

References Cited

U.S. PATENT DOCUMENTS

D563,850 S	3/2008	Rosen et al.	
D563,851 S	3/2008	Rosen et al.	
D563,852 S	3/2008	Rosen et al.	
D571,696 S	6/2008	Rosen et al.	
D578,453 S	10/2008	Raghavendran et al.	
D588,512 S	3/2009	Raghavendran et al.	
D621,754 S	8/2010	Angelo et al.	
D622,188 S	8/2010	Angelo et al.	
D632,234 S	2/2011	Peltola et al.	
D647,832 S	11/2011	Medina et al.	
D654,401 S	2/2012	Peltola et al.	
D654,417 S	2/2012	Peltola et al.	
D686,122 S	7/2013	Peltola et al.	
D690,242 S	9/2013	Conway et al.	
D690,632 S	10/2013	Peltola et al.	
D699,650 S	2/2014	Peltola et al.	
D699,651 S	2/2014	Peltola et al.	
D706,690 S	6/2014	Peltola et al.	
D707,160 S	6/2014	Peltola et al.	
D707,161 S	6/2014	Peltola et al.	
D707,163 S	6/2014	Peltola et al.	
D708,104 S	7/2014	Conway et al.	
D708,553 S	7/2014	Conway et al.	
D708,985 S	7/2014	Peltola et al.	
D708,986 S	7/2014	Conway et al.	
D708,999 S	7/2014	Conway et al.	
D709,000 S	7/2014	Peltola et al.	
D709,001 S	7/2014	Conway et al.	
D709,406 S	7/2014	Conway et al.	
D709,407 S	7/2014	Conway et al.	
D709,408 S	7/2014	Peltola et al.	
D709,411 S	7/2014	Peltola et al.	
D709,421 S	7/2014	Conway et al.	
D709,422 S	7/2014	Peltola et al.	
D709,423 S	7/2014	Peltola et al.	
D709,424 S	7/2014	Conway et al.	
D709,425 S	7/2014	Conway et al.	
D729,709 S	5/2015	Conway et al.	
D737,743 S *	9/2015	Duff .....	D12/173
D743,309 S *	11/2015	Thole .....	D12/173
D743,857 S *	11/2015	McMahan .....	D12/173
D746,740 S *	1/2016	Wolff .....	D12/173
D748,545 S *	2/2016	Behmer .....	D12/173
D765,568 S *	9/2016	Frascella .....	D12/173
D775,019 S *	12/2016	Wheel .....	D12/173
D777,621 S *	1/2017	Kim .....	D12/173
D777,622 S *	1/2017	Kozub .....	D12/173
D782,381 S	3/2017	Conway et al.	
D787,992 S *	5/2017	Lee .....	D12/173
D787,993 S *	5/2017	McCabe .....	D12/173
D789,260 S *	6/2017	Smith .....	D12/173
D804,372 S *	12/2017	Kozub .....	D12/173
D805,981 S	12/2017	Conway et al.	
D862,319 S	10/2019	Duncan et al.	
D862,320 S	10/2019	Duncan et al.	
D862,321 S	10/2019	Duncan et al.	
D862,322 S	10/2019	Duncan et al.	
D862,323 S	10/2019	Duncan et al.	
D862,324 S	10/2019	Duncan et al.	
D863,172 S	10/2019	Duncan et al.	
D885,281 S	5/2020	Duncan et al.	
2004/0256024 A1 *	12/2004	Schlachter .....	B60K 15/04 141/86
2005/0280287 A1 *	12/2005	Koura .....	B60R 21/34 296/193.11
2016/0280279 A1 *	9/2016	Yoshida .....	B62D 25/12
2018/0056927 A1 *	3/2018	Yamada .....	E05D 3/125

OTHER PUBLICATIONS

“T800,” Kenworth Truck Company, 2009, 28-page brochure.  
 “T800B,” Kenworth Truck Company, 1993, 8-page brochure.  
 Peterbilt Motors Company, “The Working Class,” Sep. 1976, 6-page brochure.

“The World’s Best,” Kenworth Truck Company, 1992, 12-page brochure.  
 “W900,” Kenworth Truck Company, 1996, 7-page brochure.  
 “W900,” Kenworth Truck Company, 2002, 32-page brochure.  
 “W900,” Kenworth Truck Company, 2005, 32-page brochure.  
 “W900,” Kenworth Truck Company, 2009, 28-page brochure.  
 Kenworth Truck Company, “W900L AeroCab,” 1994, 2-page brochure.  
 Kenworth Truck Company, “AeroCab,” 1993, 6-page brochure.  
 “AeroCab,” Kenworth Truck Company, as early as 1995, 3-page brochure.  
 “C500B,” Kenworth Truck Company, as early as 1990, 4-page brochure.  
 Peterbilt Motors Company, “Class Pays, Medium Duty,” Sep. 2000, 12-page brochure.  
 “Class Pays, Truck Models,” Peterbilt Motors Company, Mar. 2005, 24-page brochure.  
 “Class Pays,” Peterbilt Motors Company, Nov. 1998, 10-page brochure.  
 Peterbilt Motors Company, “Class Pays,” Sep. 1997, 10-page brochure.  
 “Class Pays, Construction Trucks,” Peterbilt Motors Company, Nov. 2003, 16-page brochure.  
 “Kenworth Truck Models,” Kenworth Truck Company, 2010, 16-page brochure.  
 Peterbilt Motors Company, “Model 330,” Oct. 1997, 3-page brochure.  
 Peterbilt Motors Company, “Model 379,” Apr. 2005, 2-page brochure.  
 Peterbilt Motors Company, “Model 379,” Mar. 1996, 5-page brochure.  
 Peterbilt Motors Company, “Rest with Class,” Apr. 1978, 4-page brochure.  
 “T170 Class 5,” Kenworth Truck Company, 2008, 4-page brochure.  
 “T270 Class 6 and T370 Class 7,” Kenworth Truck Company, 2008, 6-page brochure.  
 “T270 Class 6 and T370 Class 7,” Kenworth Truck Company, 2009, 6-page brochure.  
 “T270 Class 6 and T370 Class 7 Hybrid,” Kenworth Truck Company, 2009, 6-page brochure.  
 “T680,” Kenworth Truck Company, 2013, 34-page brochure.  
 “T680,” Kenworth Truck Company, 2016, 34-page brochure.  
 “T880,” Kenworth Truck Company, 2017, 32-page brochure.  
 “Model 579,” Peterbilt Motors Company, Oct. 2013, 13-page brochure.  
 “Medium Duty,” Peterbilt Motors Company, 2013, 9-page brochure.  
 “On-Highway,” Peterbilt Motors Company, 2013, 13-page brochure.  
 “Vocational,” Peterbilt Motors Company, 2013, 11-page brochure.  
 “T440,” Kenworth Truck Company, 2010, 6-page brochure.  
 “T470,” Kenworth Truck Company, 2010, 6-page brochure.  
 “T470H,” Kenworth Truck Company, 2009, 2-page brochure.  
 “Model 220,” Peterbilt Motors Company, 2019, 2-page brochure.  
 “220EV,” Peterbilt Motors Company, 2020, 5-page brochure.  
 “Model 337,” Peterbilt Motors Company, 2020, 2-page brochure.  
 “Model 389,” Peterbilt Motors Company, 2019, 2-page brochure.  
 “Model 348,” Peterbilt Motors Company, 2019, 2-page brochure.  
 “Model 520,” Peterbilt Motors Company, 2019, 2-page brochure.  
 “Model 567,” Peterbilt Motors Company, 2020, 16-page brochure.  
 “567 Heritage,” Peterbilt Motors Company, 2017, 2-page brochure.  
 “Model 579,” Peterbilt Motors Company, 2019, 28-page brochure.  
 “C500,” Kenworth Truck Company, 2012, 2-page brochure.  
 “T680,” Kenworth Truck Company, 2019, 40-page brochure.  
 “T800,” Kenworth Truck Company, 2012, 28-page brochure.  
 “T440/T470,” Kenworth Truck Company, 2015, 8-page brochure.  
 “K270E/K370E,” Kenworth Truck Company, 2020, 4-page brochure.  
 “T270/T370,” Kenworth Truck Company, 2019, 16-page brochure.  
 “K270/K370,” Kenworth Truck Company, 2014, 12-page brochure.  
 “W990,” Kenworth Truck Company, 2018, 32-page brochure.  
 “T880,” Kenworth Truck Company, 2019, 36-page brochure.  
 “Model 367,” Peterbilt Motors Company, <https://www.peterbilt.com/trucks/vocational/model-367>, retrieved Nov. 20, 2020, 12 pages.

(56)

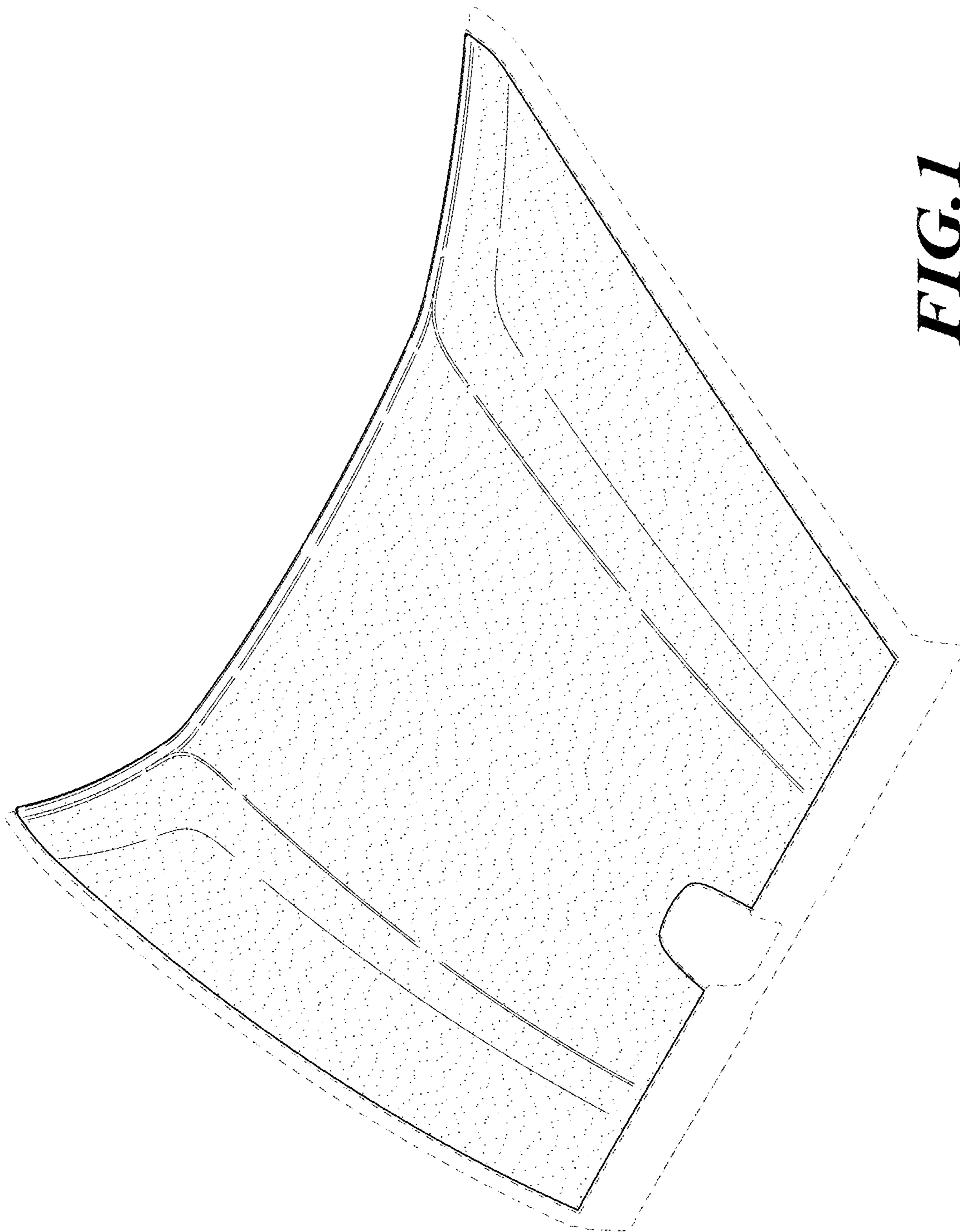
**References Cited**

OTHER PUBLICATIONS

“Model 365,” Peterbilt Motors Company, <https://www.peterbilt.com/trucks/vocational/model-365>, retrieved Nov. 20, 2020, 11 pages.

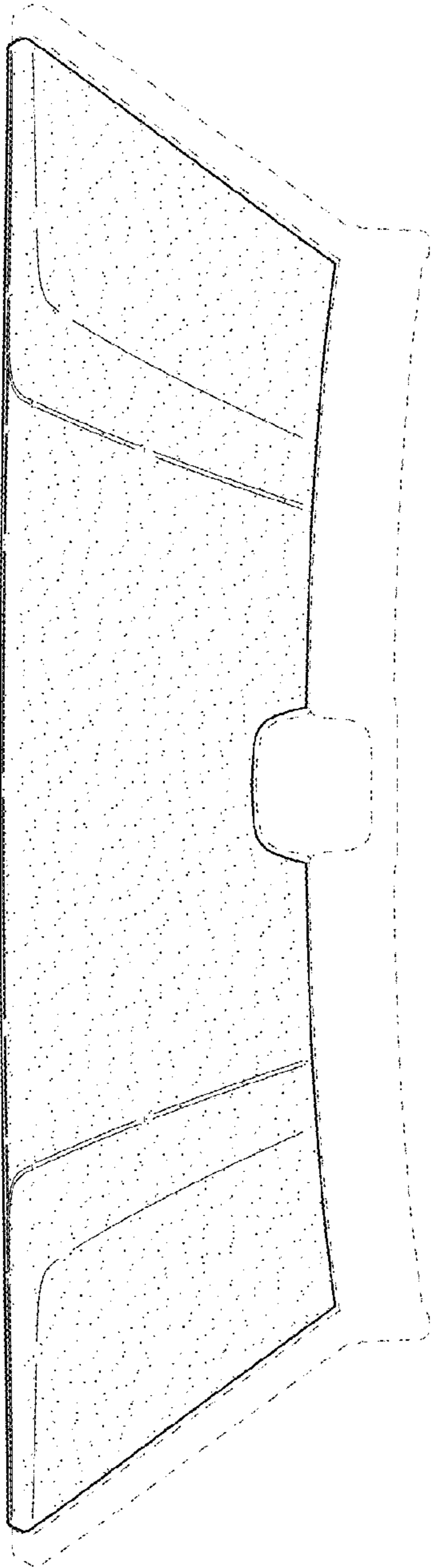
“Model 325,” Peterbilt Motors Company, <https://www.peterbilt.com/trucks/medium-duty/model-325>, retrieved Nov. 20, 2020, 12 pages.

\* cited by examiner

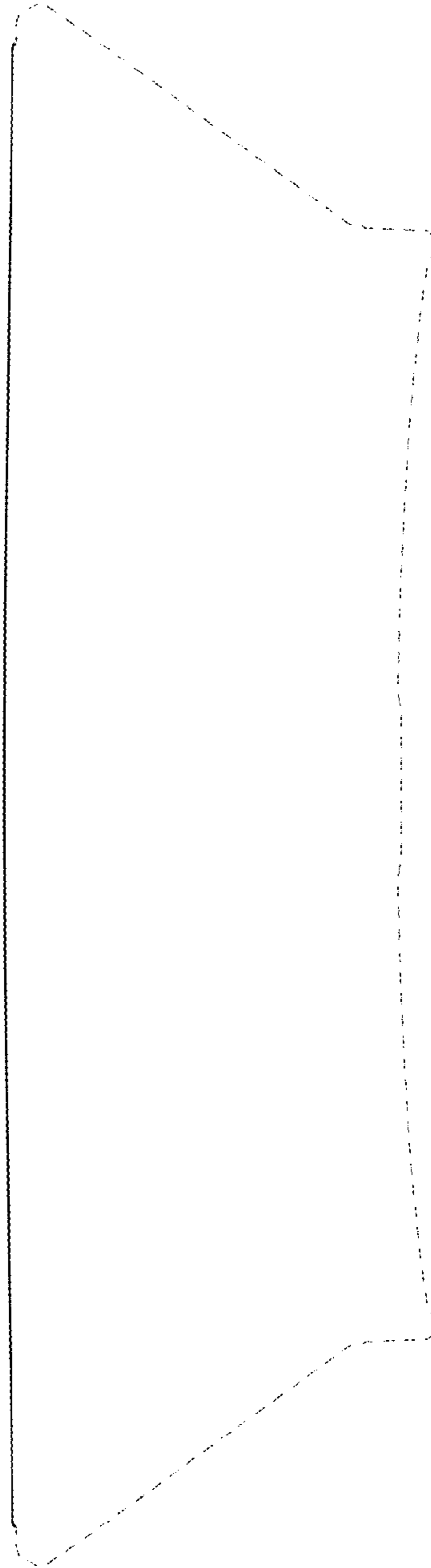


**FIG. 1**

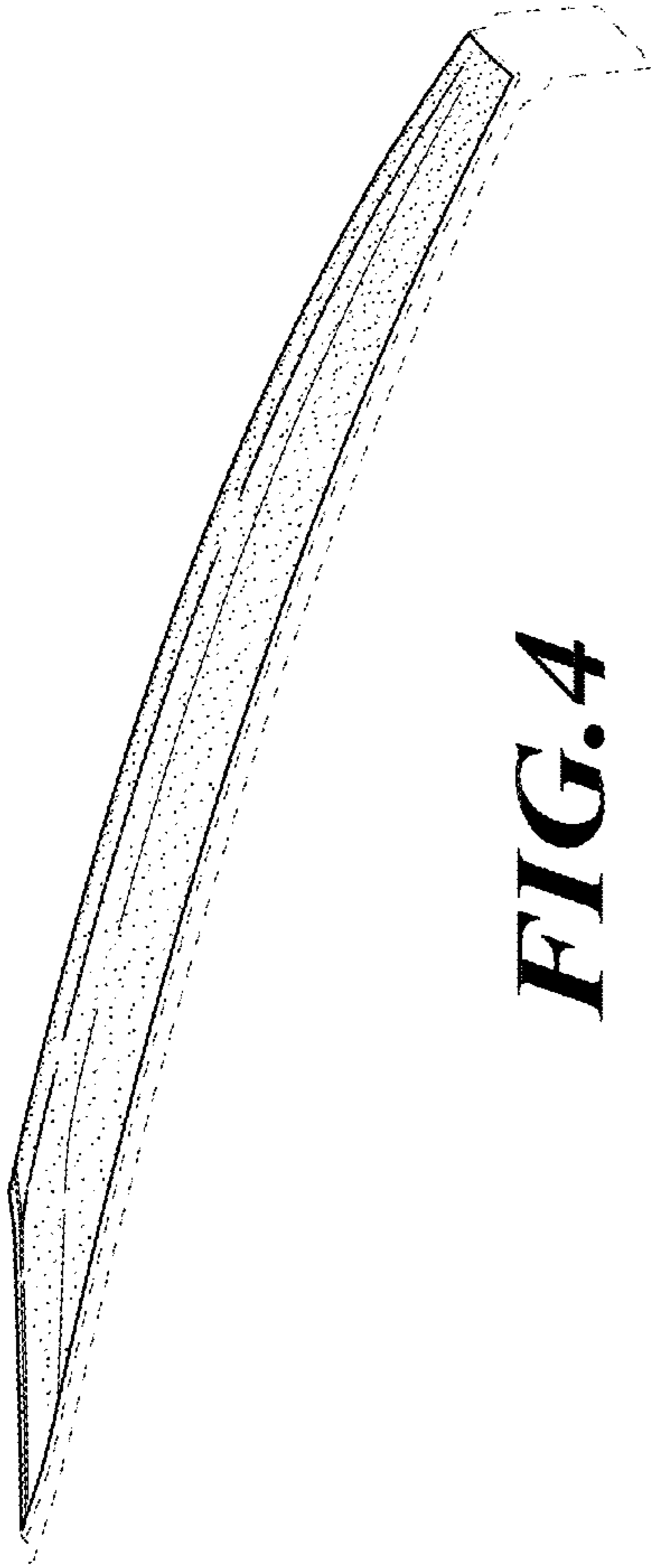




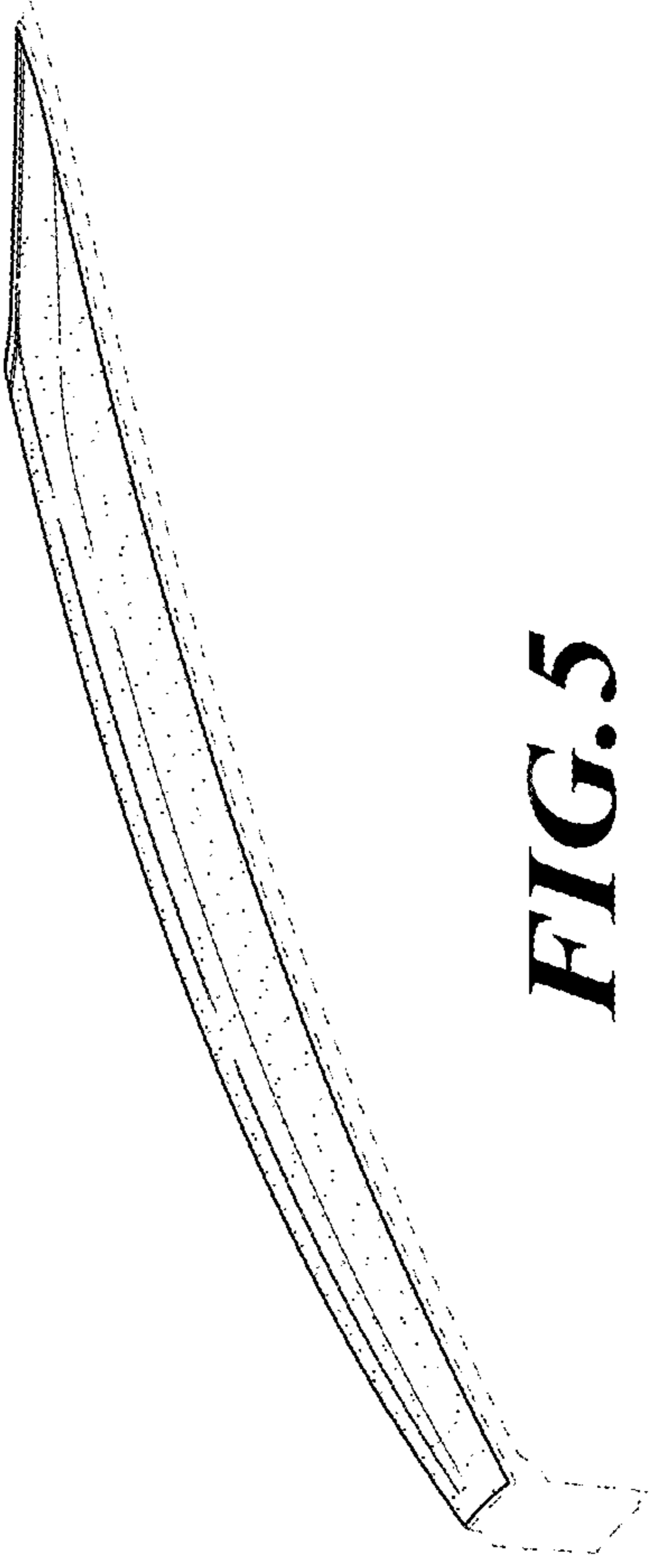
**FIG. 2**



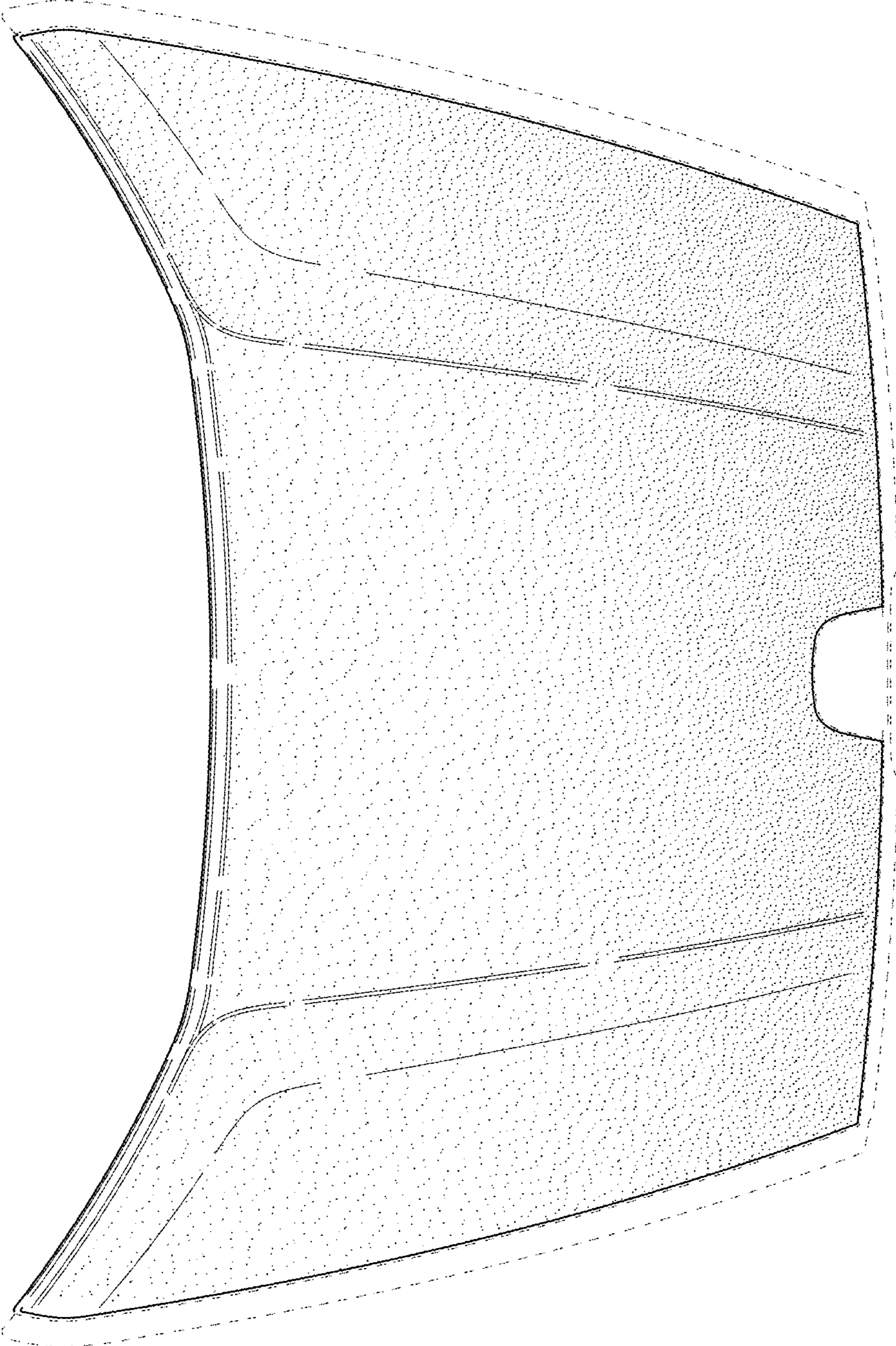
**FIG. 3**



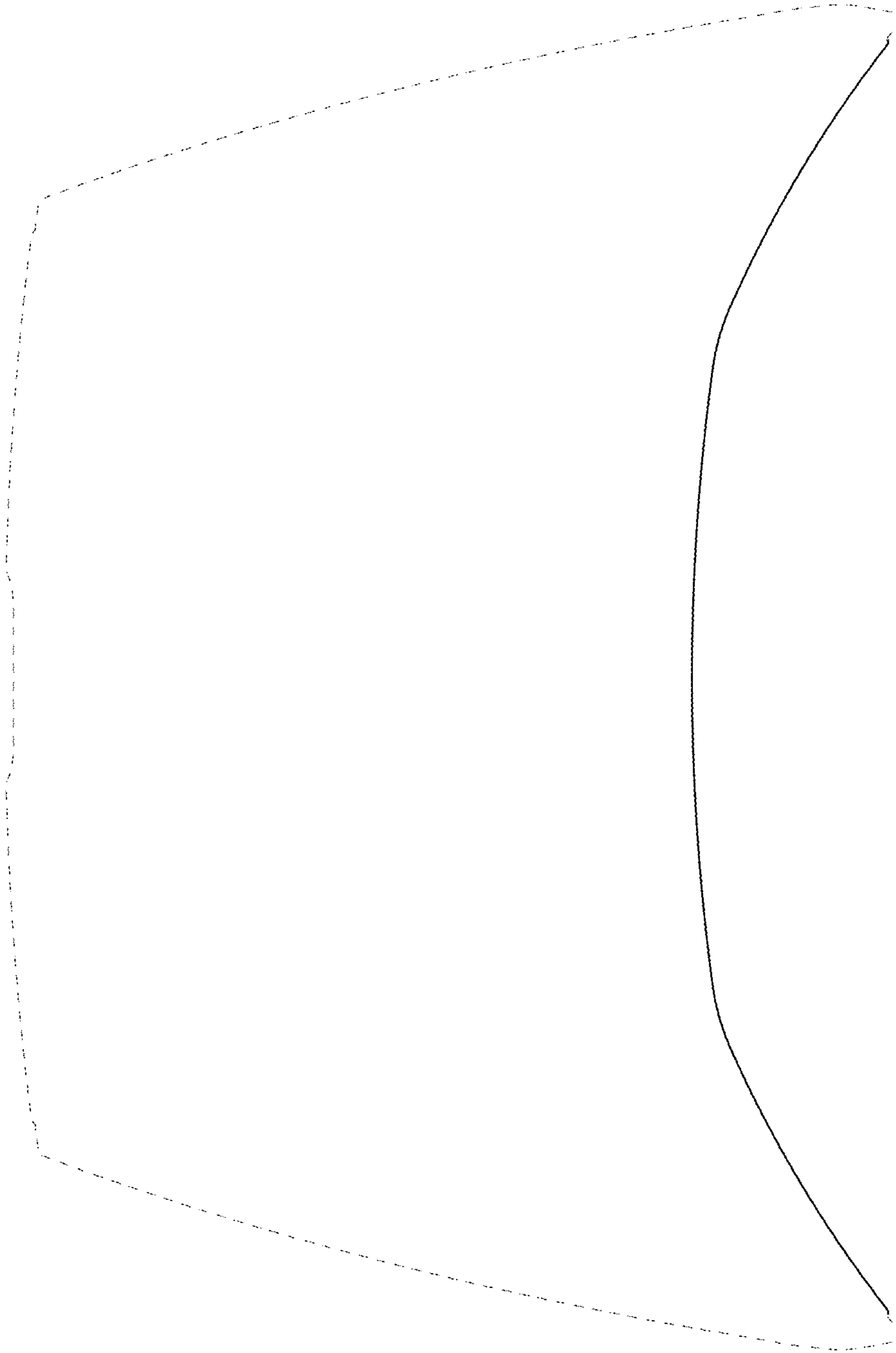
**FIG. 4**



**FIG. 5**



**FIG. 6**



**FIG. 7**