



US00D924751S

(12) **United States Design Patent** (10) **Patent No.:** **US D924,751 S**
Kaoud et al. (45) **Date of Patent:** **** Jul. 13, 2021**

(54) **VEHICLE REAR LOWER BUMPER COVER**

D869,355 S * 12/2019 Dewitt D12/169
D869,356 S * 12/2019 Dewitt D12/169
D892,686 S * 8/2020 Dewitt D12/169
D913,163 S * 3/2021 Kaoud D12/98

(71) Applicant: **Ford Global Technologies, LLC,**
Dearborn, MI (US)

(72) Inventors: **Ehab N. Kaoud,** Livonia, MI (US);
William K. Moore, West Bloomfield,
MI (US); **David Root,** Wyandotte, MI
(US); **Joshua Henry,** Detroit, MI (US)

(73) Assignee: **Ford Global Technologies, LLC,**
Dearborn, MI (US)

(**) Term: **15 Years**

(21) Appl. No.: **29/723,950**

(22) Filed: **Feb. 12, 2020**

(51) **LOC (13) Cl.** **12-16**

(52) **U.S. Cl.**
USPC **D12/169**

(58) **Field of Classification Search**
USPC ... D12/1, 14, 82, 85, 86, 87, 88, 89, 90, 91,
D12/92, 93, 96, 97, 98, 99, 163, 164,
D12/165, 167, 169, 170, 171, 172, 181,
D12/184, 185, 190, 196, 223, 400;
D21/533, 548, 552, 561
CPC B60R 19/02; B60R 19/04; B60R 19/18;
B60R 19/24; B60R 19/44; B60R 19/48;
B60R 19/56; B60R 2019/007; B60R
2019/527; B60R 2019/1886; B62D 25/08
See application file for complete search history.

(56) **References Cited**

U.S. PATENT DOCUMENTS

D579,828 S * 11/2008 Bucher D12/163
D721,304 S * 1/2015 Platto D12/169
D761,164 S * 7/2016 Platto
D775,561 S * 1/2017 Platto D12/169
D809,429 S * 2/2018 Platto D12/98

OTHER PUBLICATIONS

2021 Ford F-150, Published date unavailable [online], [retrieved on
Apr. 1, 2021]. Retrieved from the Internet: <https://shop.ford.com/build/f150/?gnav=vhpnav#/config/Config%5B%7CFord%7CF-150%7C2021%7C1%7C1.%7C900A.WIC..AZ...LTD.CCAB.RETAIL.SS5.%5D> (Year: 2021).
Andrew Wendler, The 2021 Ford F-150, Spied Testing, Looks Pretty
Evolutionary, May 8, 2019 <https://www.caranddriver.com/news/a27409108/2021-ford-f-150-pickup-spied/>.

* cited by examiner

Primary Examiner — Christian P. McLean

Assistant Examiner — Adam C Mager

(74) *Attorney, Agent, or Firm* — Michael Spenner

(57) **CLAIM**

The ornamental design for a vehicle rear lower bumper cover, as shown and described.

DESCRIPTION

FIG. 1 is a front elevational view of a vehicle rear lower bumper cover, showing our new design;
FIG. 2 is a left side elevational view thereof;
FIG. 3 is a right side elevational view thereof;
FIG. 4 is a top plan view thereof;
FIG. 5 is a bottom plan view thereof;
FIG. 6 is a top, front and left side perspective view thereof;
and,
FIG. 7 is a bottom, front and left side perspective view thereof.

The claimed design is indicated by the relatively dark portions in the figures. The de-emphasized and relatively light portions form no part of the claimed design.

1 Claim, 7 Drawing Sheets

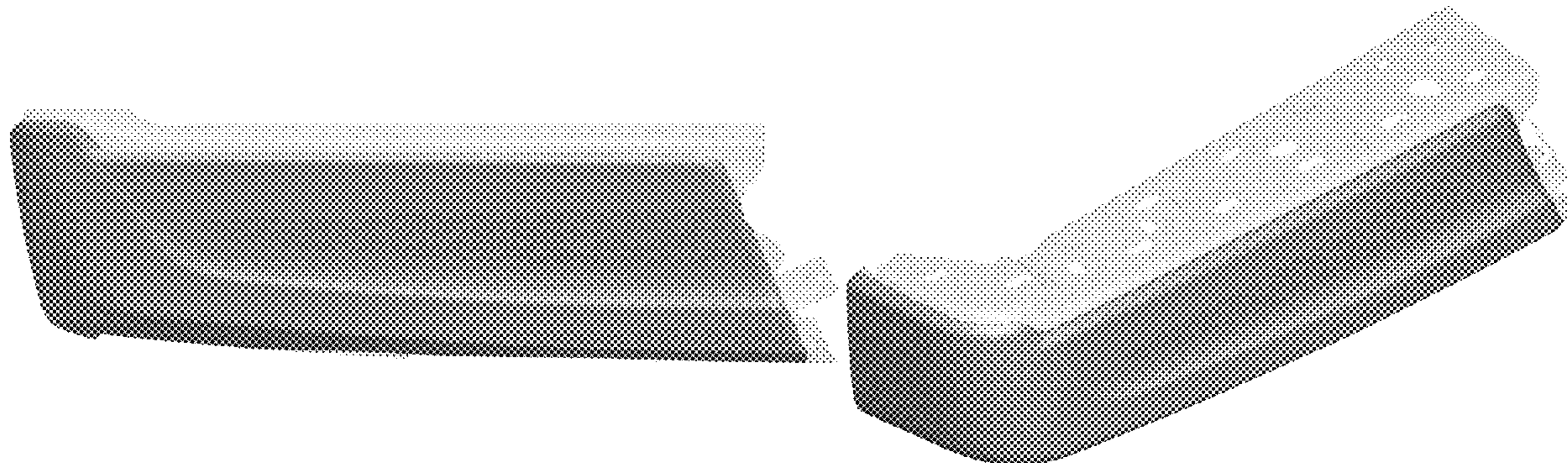

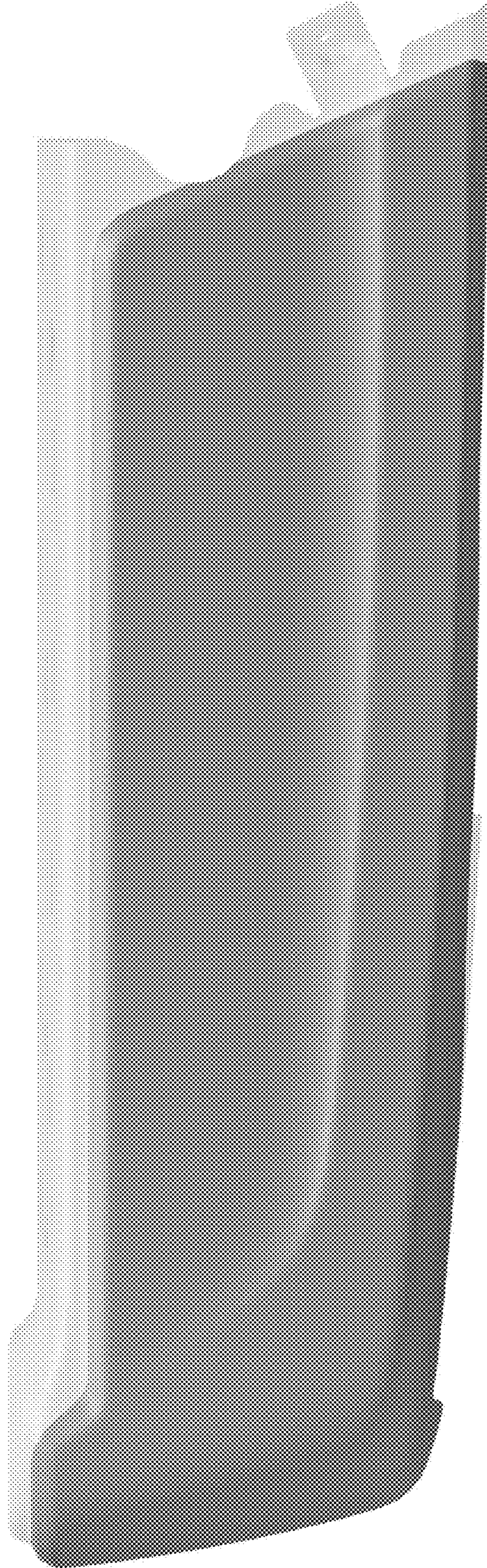

Fig.1

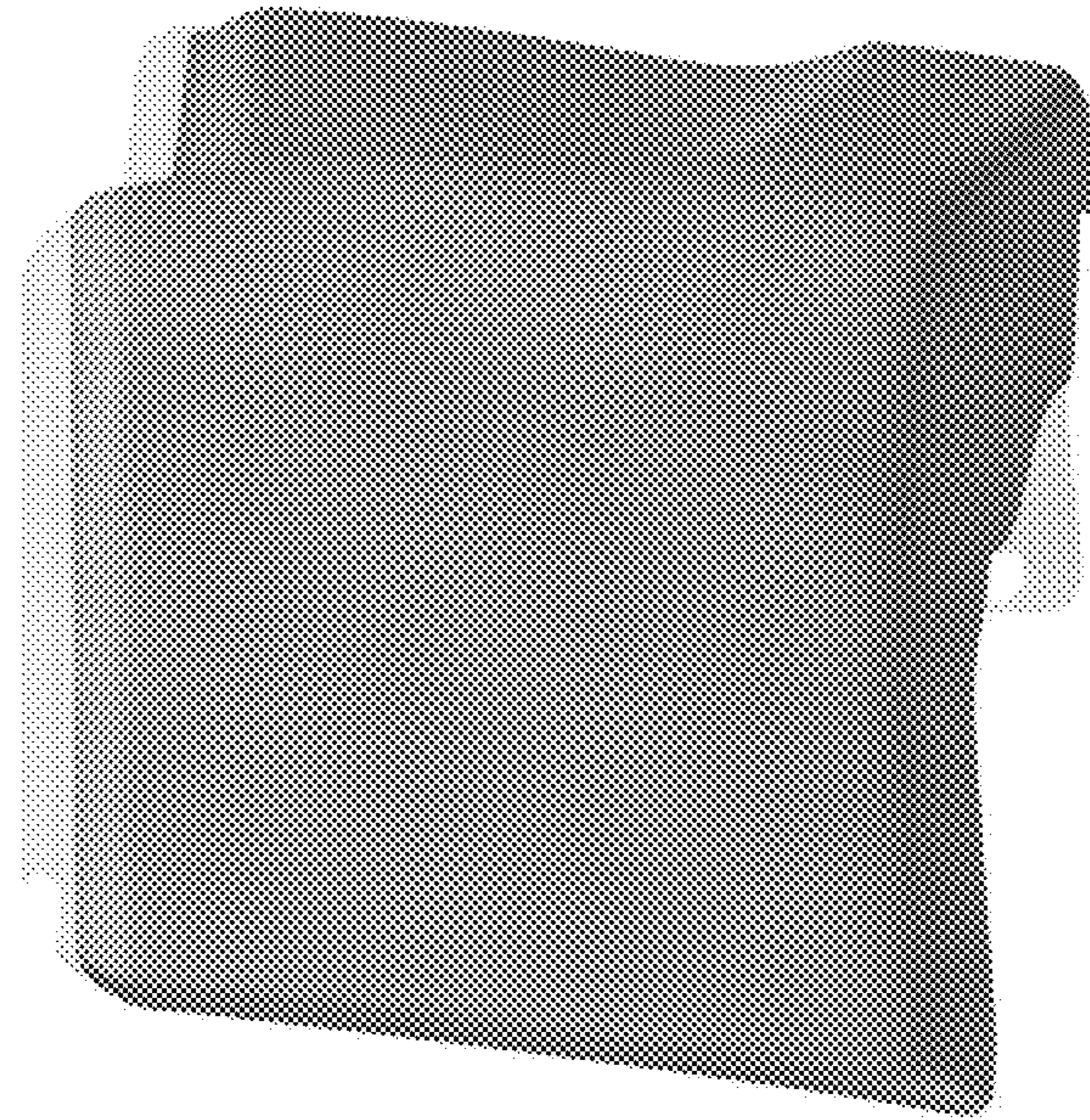

Fig. 2

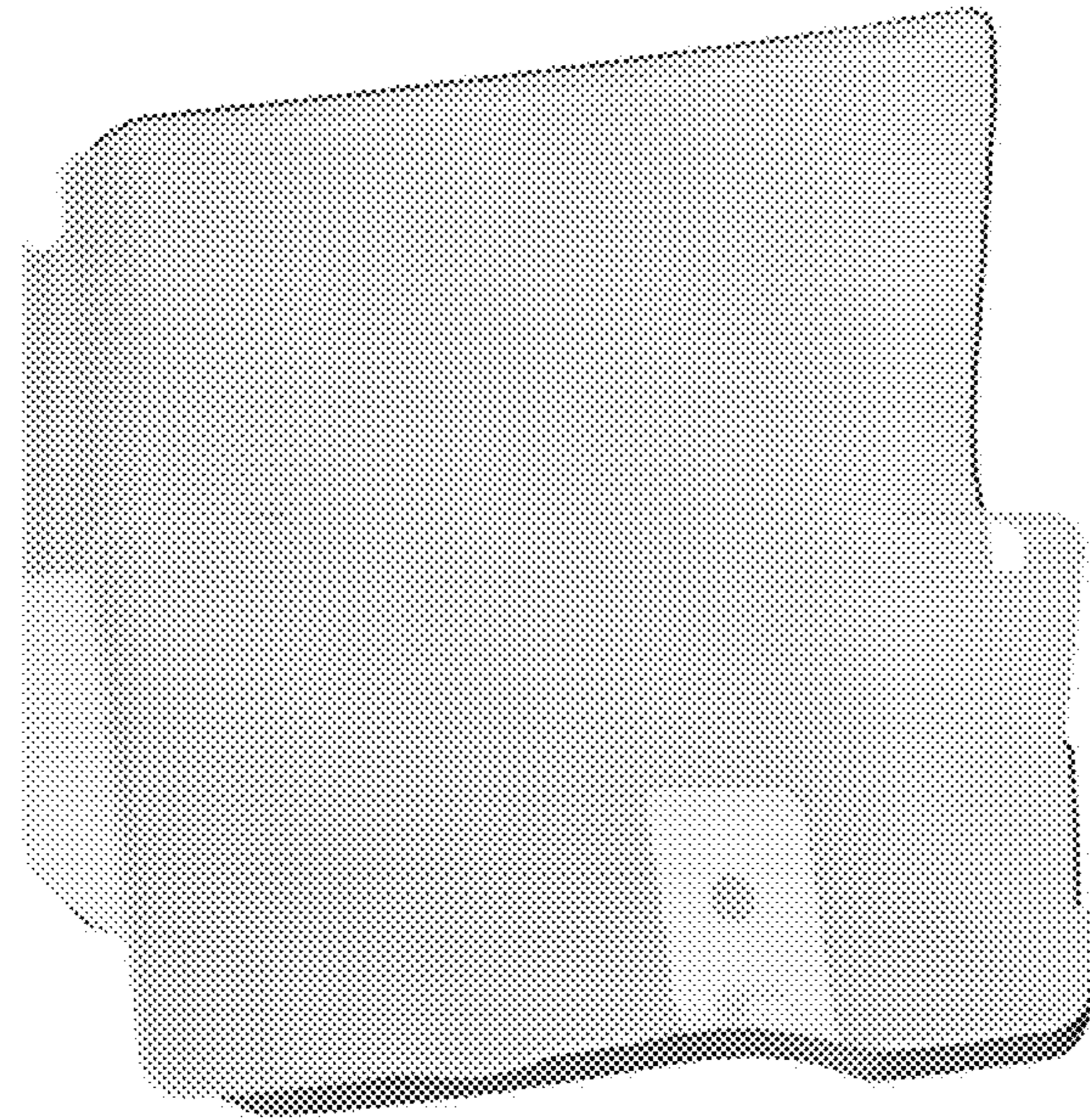

Fig. 3

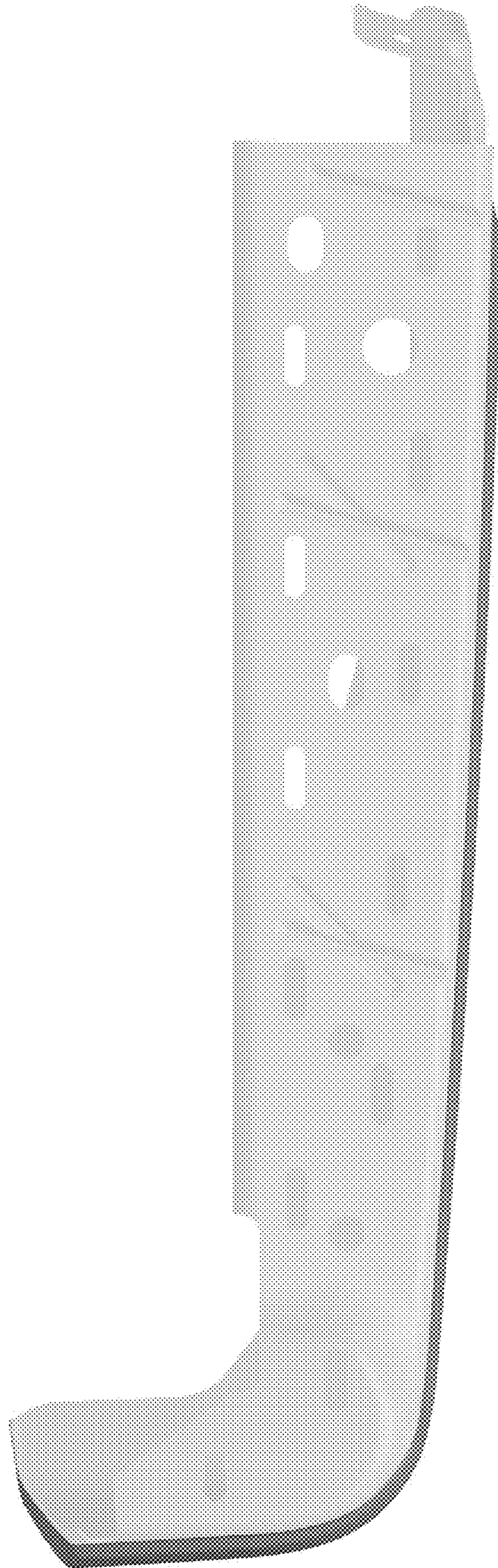

Fig.4

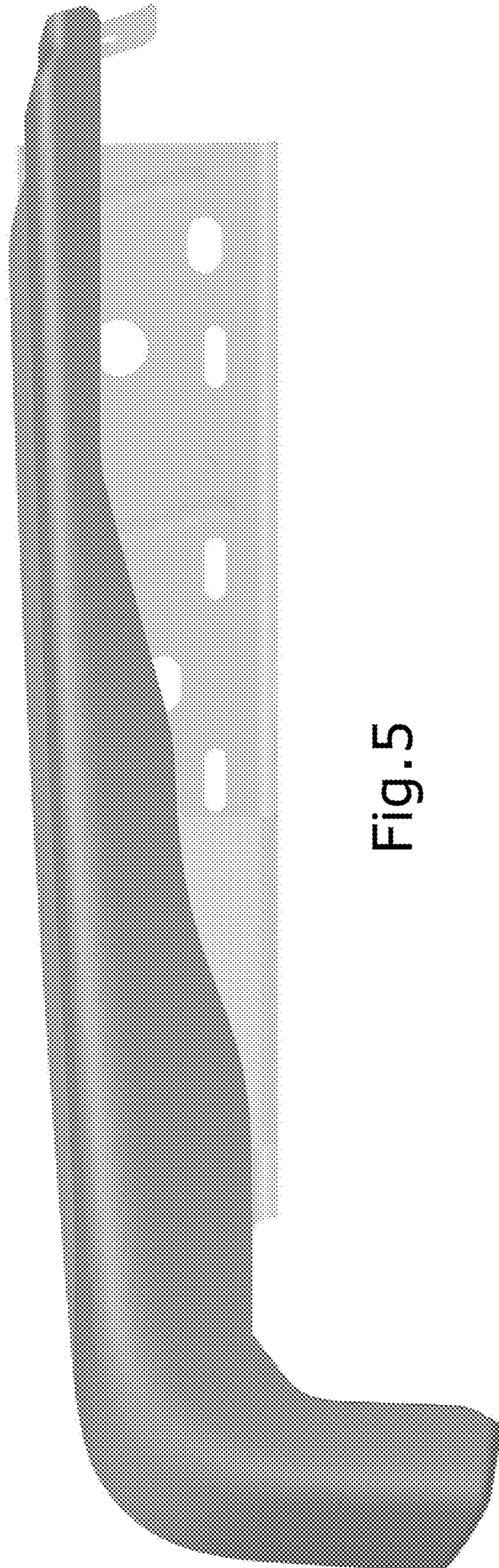

Fig. 5

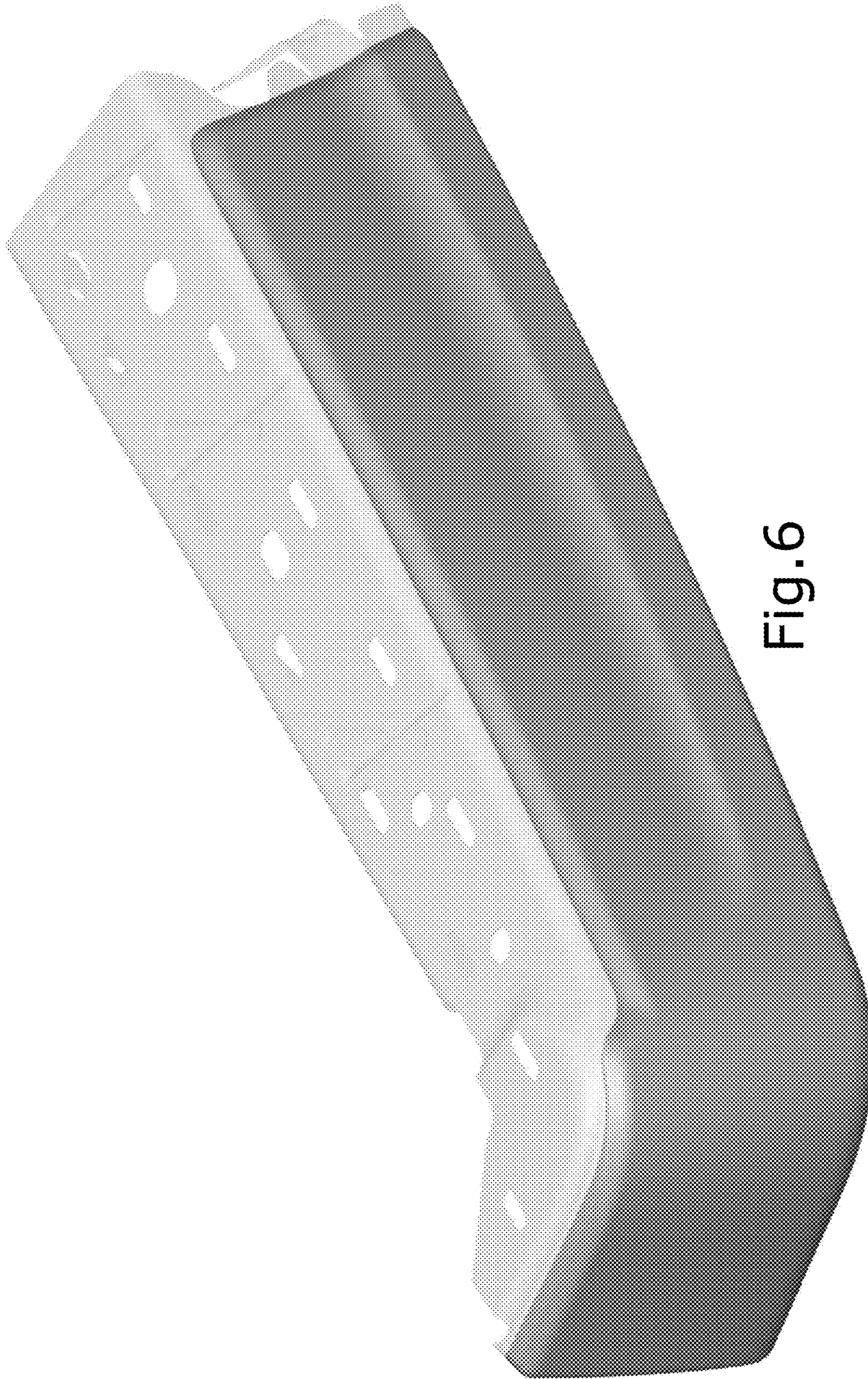

Fig. 6

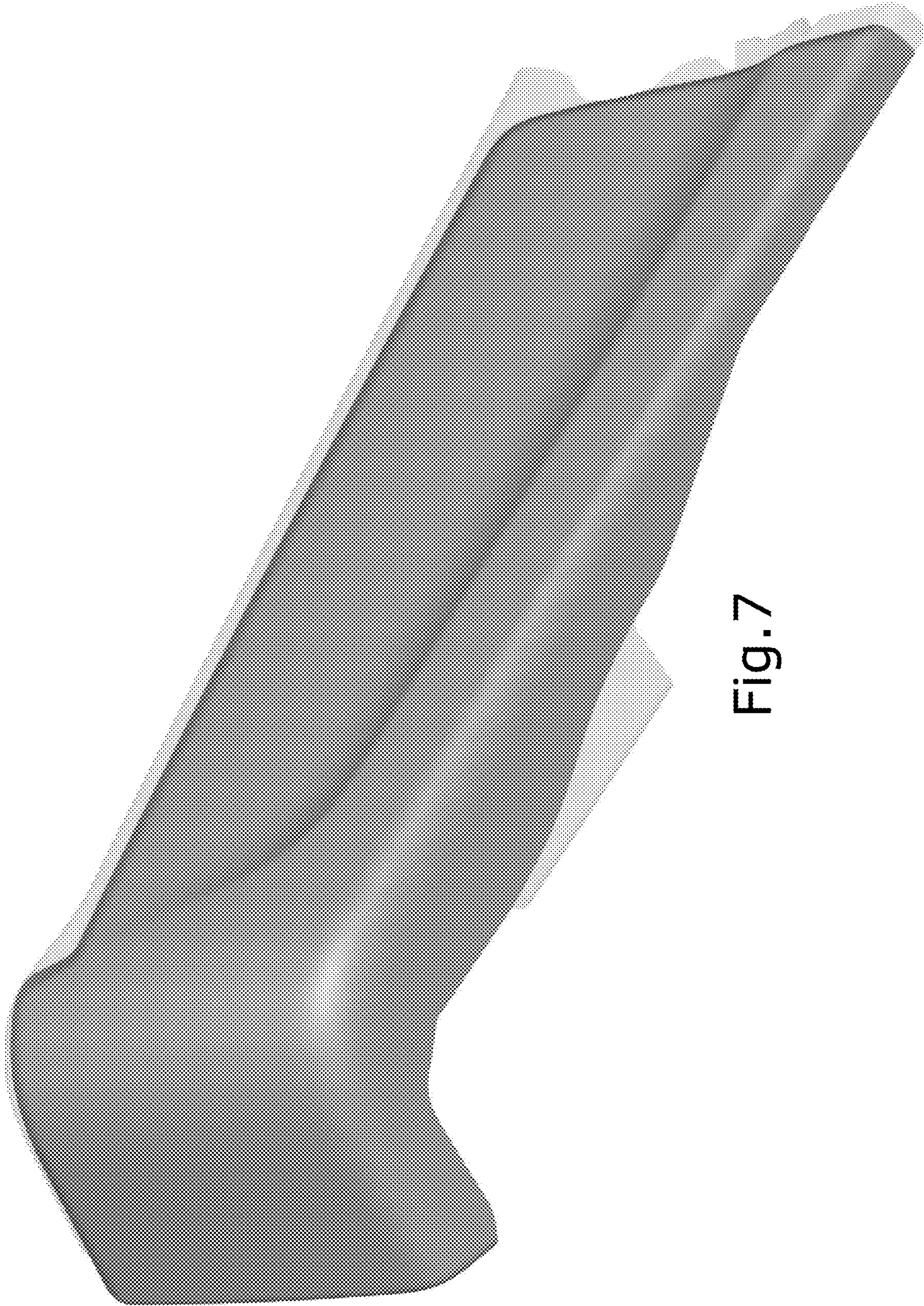

Fig. 7