



US00D924699S

(12) **United States Design Patent**
Gonet

(10) **Patent No.:** **US D924,699 S**

(45) **Date of Patent:** **** Jul. 13, 2021**

(54) **WATCH**

(71) Applicant: **LVMH SWISS MANUFACTURES SA, La-Chaux-de-Fonds (CH)**

(72) Inventor: **Fabrice Gonet, Ecublens (CH)**

(**) Term: **15 Years**

(21) Appl. No.: **35/508,974**

(22) Filed: **Sep. 5, 2019**

(80) **Hague Agreement Data**

Int. Filing Date: **Sep. 5, 2019**
Int. Reg. No.: **DM/206663**
Int. Reg. Date: **Sep. 5, 2019**
Int. Reg. Pub. Date: **Apr. 3, 2020**

(30) **Foreign Application Priority Data**

Mar. 15, 2019 (WO) DM/200836

(51) **LOC (13) Cl.** **10-02**

(52) **U.S. Cl.**
USPC **D10/39**

(58) **Field of Classification Search**
USPC D10/32, 39
CPC G04C 10/04
See application file for complete search history.

(56) **References Cited**

U.S. PATENT DOCUMENTS

D391,501 S * 3/1998 Giardiello D10/30
D445,344 S * 7/2001 Haquet D10/30
D459,236 S * 6/2002 Haquet D10/30
D577,297 S * 9/2008 Lalo D10/32
D649,889 S * 12/2011 Giannini D10/32
D650,710 S * 12/2011 Laucella D10/39

D656,416 S * 3/2012 Monachon D10/39
D703,553 S * 4/2014 Monachon D10/32
D720,239 S * 12/2014 Mijatovic D10/32
D720,240 S * 12/2014 Takahashi D10/39
D730,201 S * 5/2015 Giannini D10/39
D735,060 S * 7/2015 Monachon D10/32
D762,126 S * 7/2016 Izuka D10/32
D774,926 S * 12/2016 Butler D10/39
D793,879 S * 8/2017 Tonohori D10/39
D809,940 S * 2/2018 Babcock D10/39
D822,510 S * 7/2018 Kwong D10/39
10,101,708 B2 * 10/2018 Yamada G04C 10/04
D833,302 S * 11/2018 Soares D10/39
D835,523 S * 12/2018 Pillot D10/39
D836,008 S * 12/2018 Schoepfer D10/39
D840,844 S * 2/2019 Le Bot D10/39
D892,654 S * 8/2020 Gabrys D10/78
D899,281 S * 10/2020 Takano D10/81
D906,137 S * 12/2020 Stern D10/39
D909,539 S * 2/2021 Zhou D23/235
D912,548 S * 3/2021 Takahashi D10/39
2017/0277132 A1 * 9/2017 Nozawa G04C 10/04

* cited by examiner

Primary Examiner — George D. Kirschbaum

(74) *Attorney, Agent, or Firm* — Brinks Gilson & Lione;
John C. Freeman

(57) **CLAIM**

The ornamental design for a watch, as shown and described.

DESCRIPTION

- 1. Watch
- 1.1 is a perspective view of a watch showing my new design;
- 1.2 is a top view thereof;
- 1.3 is a bottom view thereof;
- 1.4 is a front view thereof;
- 1.5 is a back view thereof;
- 1.6 is a right view thereof; and
- 1.7 is a left view thereof.

1 Claim, 7 Drawing Sheets

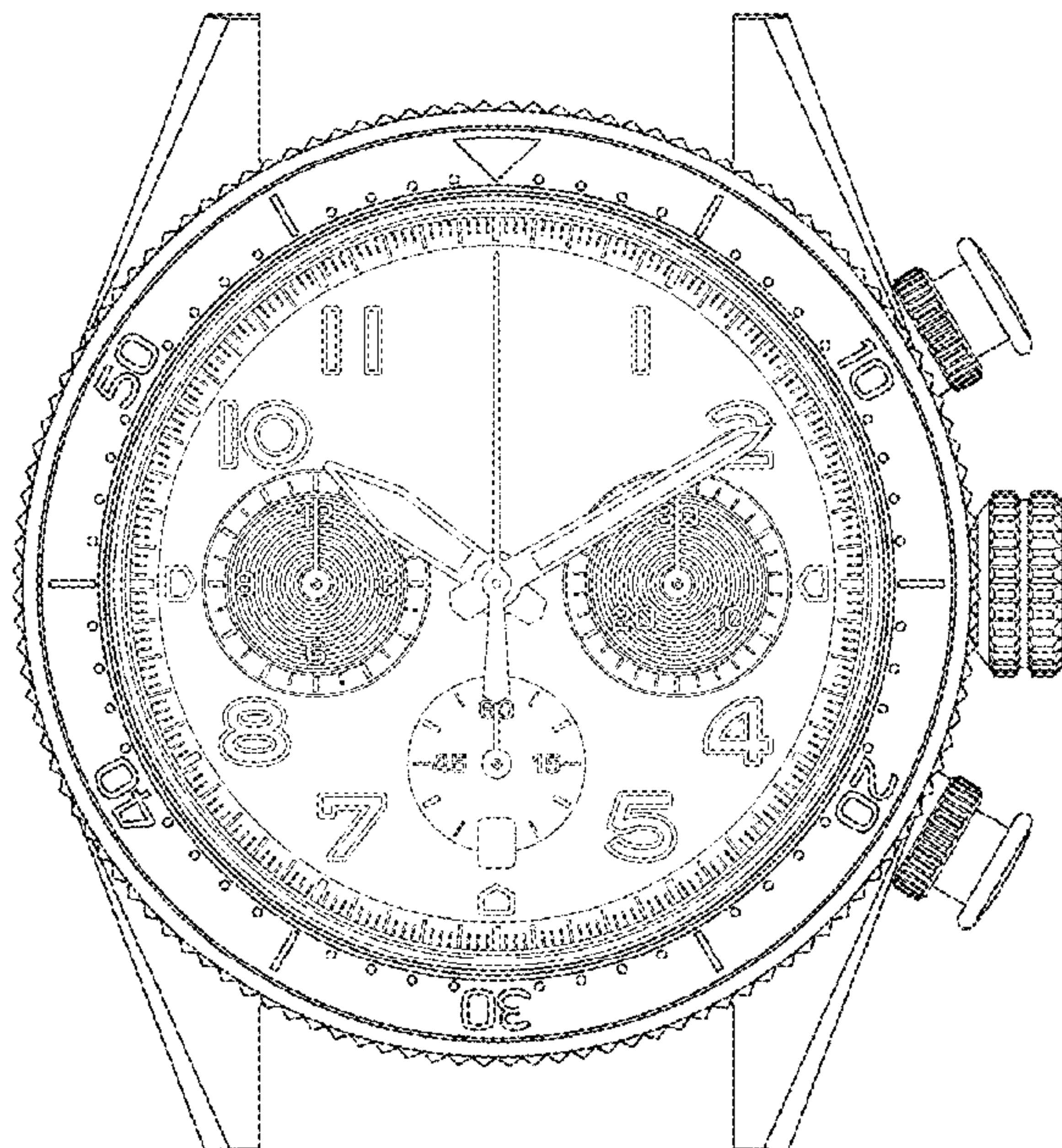

1.1

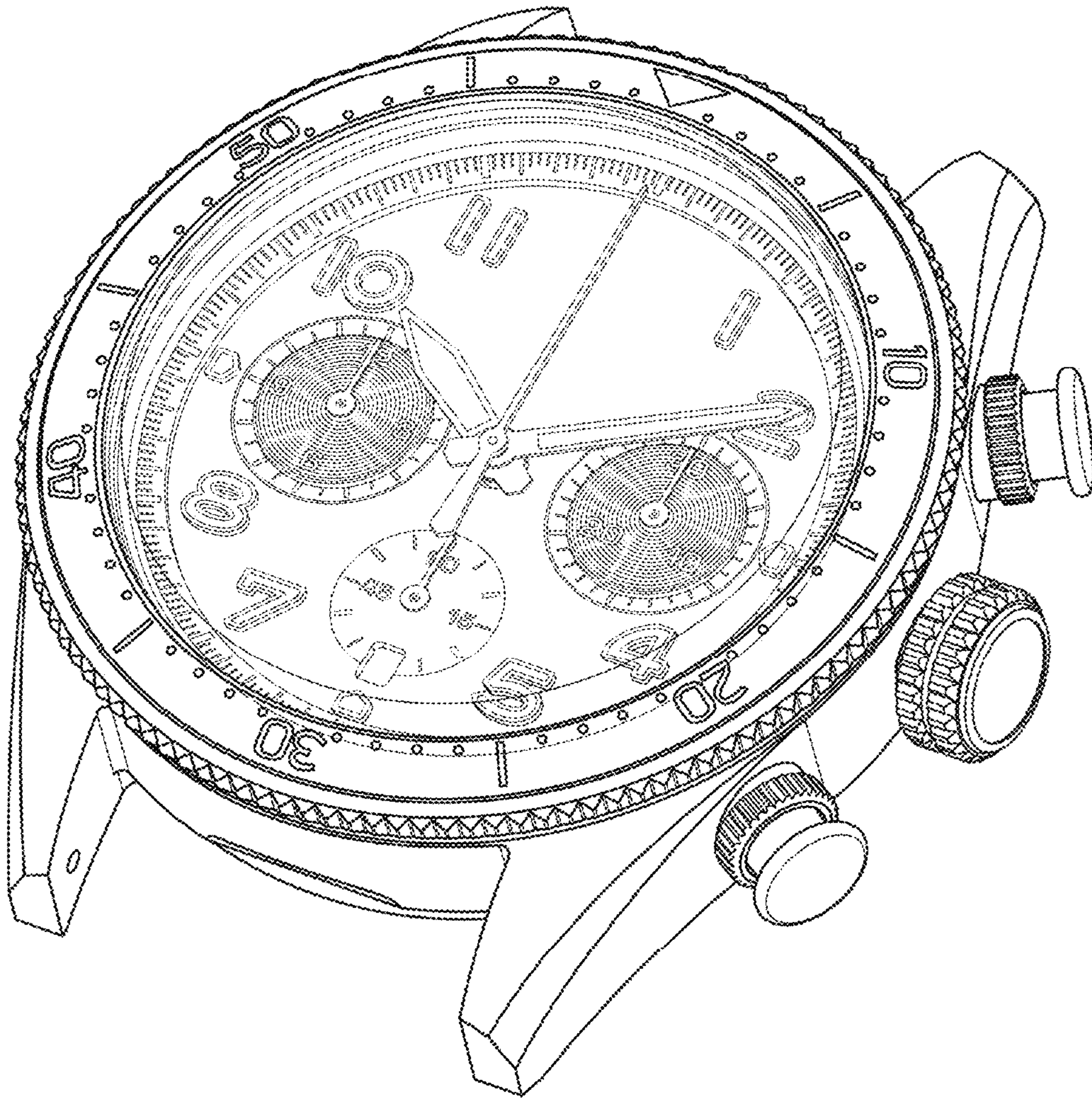

1.2

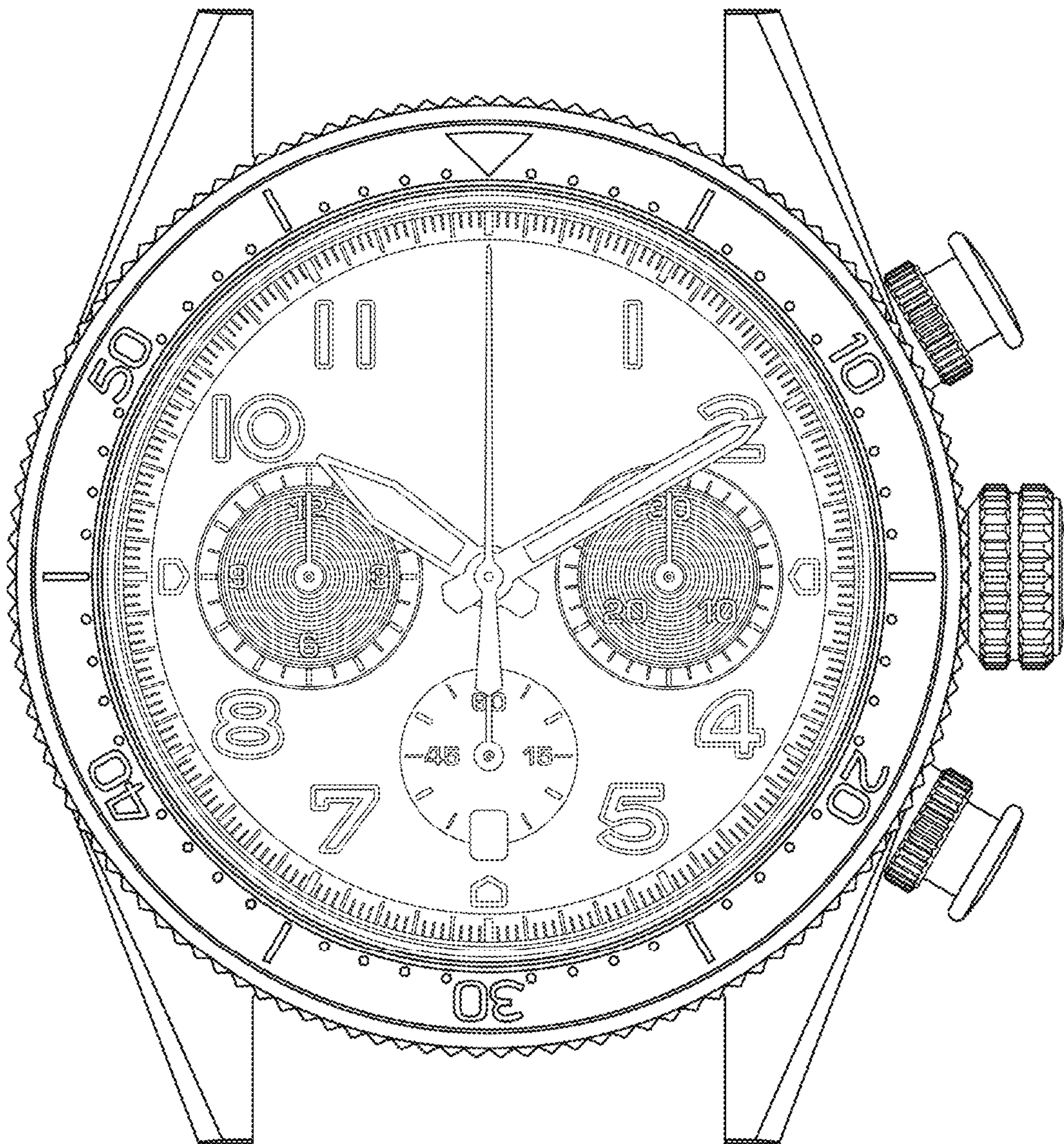

1.3

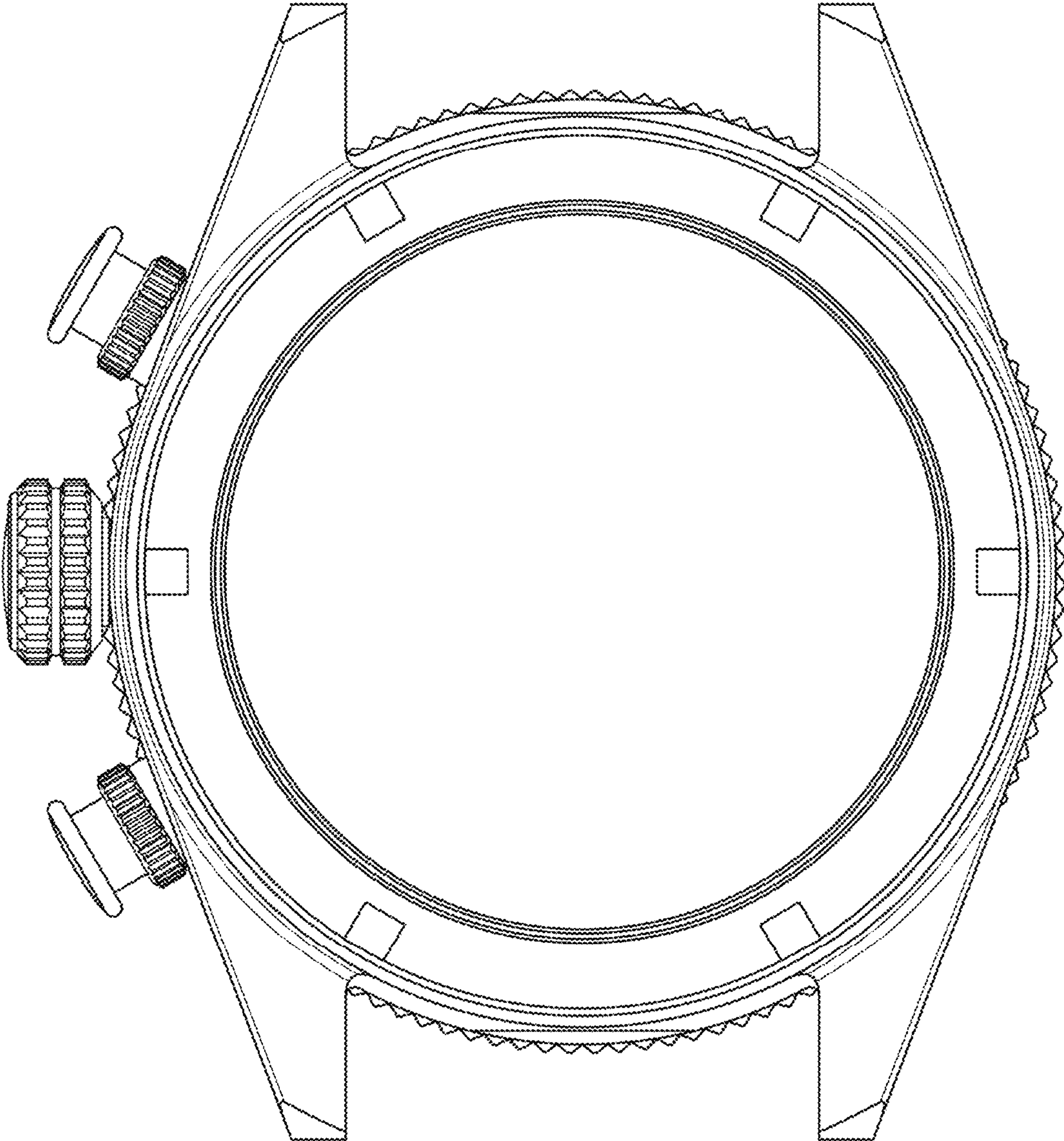

1.4

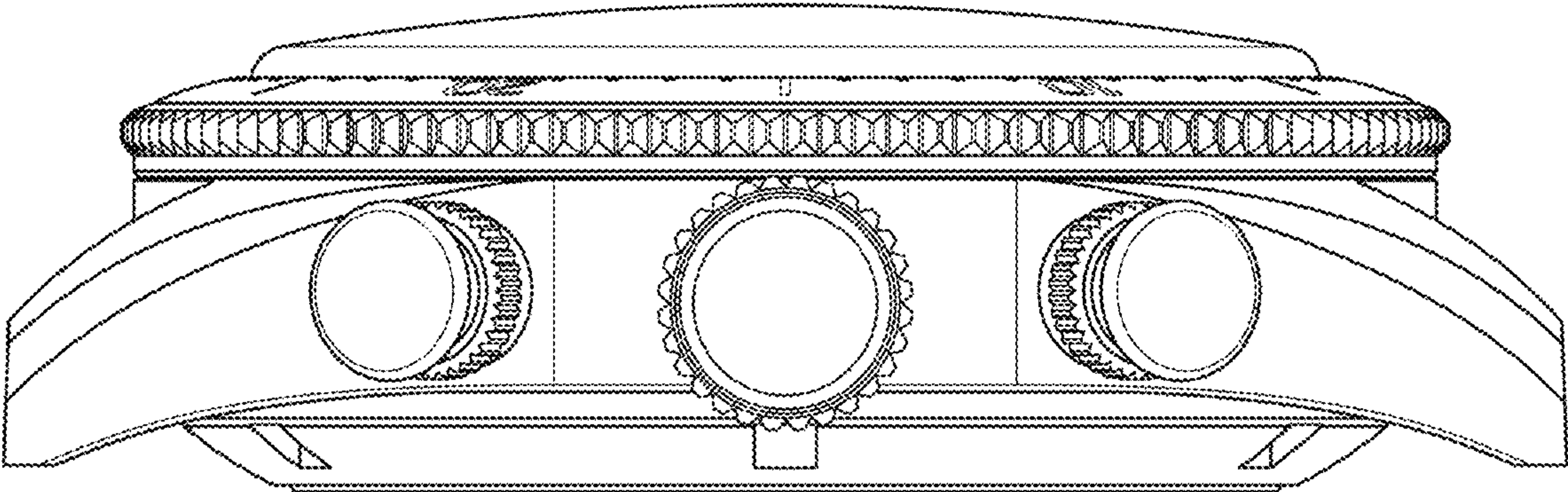

1.5

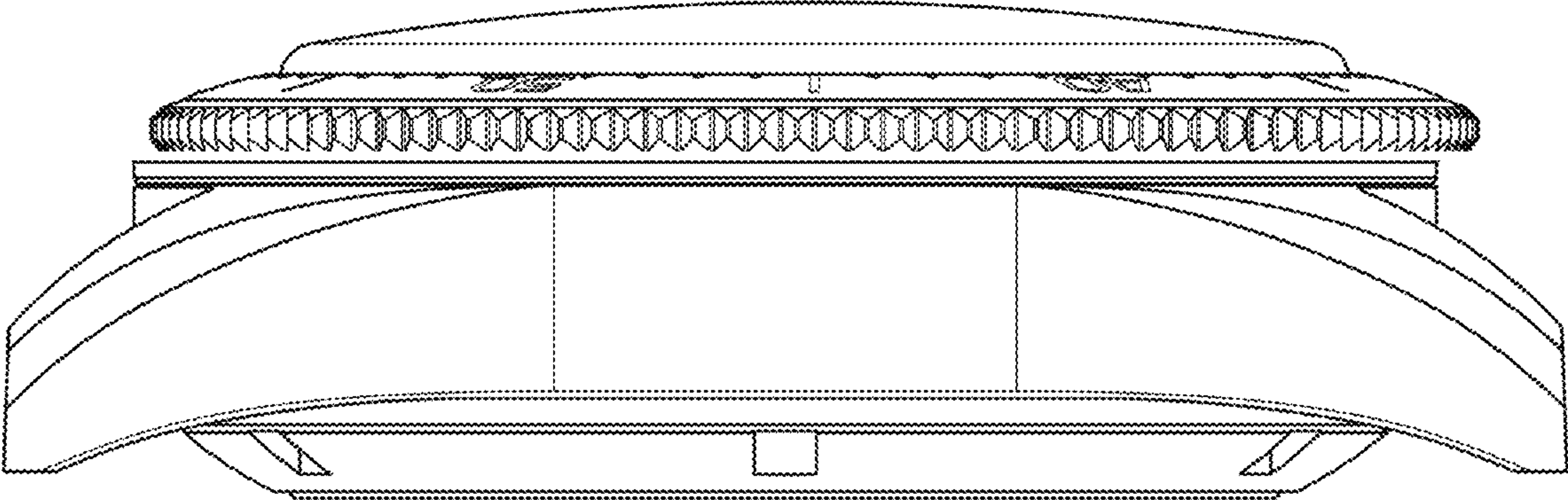

1.6

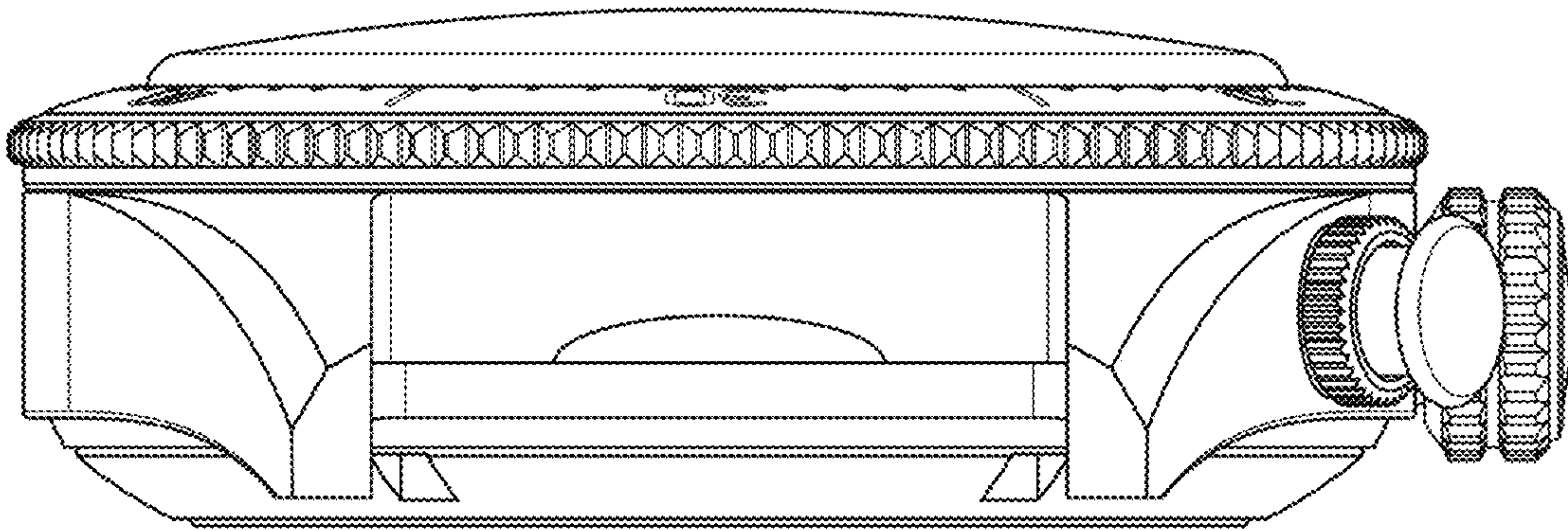

1.7

