



US00D924688S

(12) **United States Design Patent**
Marcrum et al.

(10) **Patent No.:** **US D924,688 S**
(45) **Date of Patent:** **** Jul. 13, 2021**

(54) **SNACK CONTAINER**

(71) Applicant: **RING CONTAINER TECHNOLOGIES, LLC**, Oakland, TN (US)

(72) Inventors: **Christopher Marcrum**, Cordova, TN (US); **Paul Vincent Kelley**, Arlington, TN (US)

(73) Assignee: **RING CONTAINER TECHNOLOGIES, LLC**, Oakland, TN (US)

(**) Term: **15 Years**

(21) Appl. No.: **29/713,426**

(22) Filed: **Nov. 15, 2019**

(51) **LOC (13) Cl.** **09-01**

(52) **U.S. Cl.**
USPC **D9/543; D9/540; D9/563**

(58) **Field of Classification Search**
USPC D9/440, 443, 447, 516, 520, 523–528, D9/530–543, 550, 551, 552, 554, 556, D9/558, 563, 428, 573–575, 564, 522, D9/529; D7/396.2, 507, 509, 510, 511, D7/532, 533, 608, 631–634; D3/202, 23; D6/518, 523, 734
CPC B65D 1/0223; B65D 2543/00296; B65D 2543/00092; B65D 2543/00537; B65D 2501/0081; B65D 23/10; B65D 23/102; A47J 43/27

See application file for complete search history.

(56) **References Cited**

U.S. PATENT DOCUMENTS

D389,067 S * 1/1998 Lown D9/543
D413,200 S * 8/1999 Baker D3/23

D462,012 S * 8/2002 Manderfield, Jr. D9/530
D480,974 S * 10/2003 Blank D9/543
D651,093 S * 12/2011 Van Rens D9/541
D701,769 S * 4/2014 Eble D9/574
D722,884 S * 2/2015 Eble D9/543
9,033,194 B1 * 5/2015 Grabowski B65D 83/04
222/566
D760,088 S * 6/2016 Kaye D9/563
D792,781 S * 7/2017 Shaver D9/563
D794,468 S * 8/2017 Ivie D9/563
D855,473 S * 8/2019 Liu D9/563
D856,154 S * 8/2019 Liu D9/563
2019/0248535 A1 * 8/2019 Liu B65D 1/023

* cited by examiner

Primary Examiner — Brett Miller

Assistant Examiner — Rani J Abdallah

(74) *Attorney, Agent, or Firm* — Sorell, Lenna & Schmidt, LLP

(57) **CLAIM**

The ornamental design for a snack container, as shown and described.

DESCRIPTION

FIG. 1 is a perspective view of a snack container; FIG. 2 is a side view of the snack container; FIG. 3 is a side view of the snack container; FIG. 4 is a rear view of the snack container; FIG. 5 is a front view of the snack container; FIG. 6 is a top view of the snack container; FIG. 7 is a bottom view of the snack container; and, FIG. 8 is a cross-sectional view of a portion of the snack container at detail 8-8 in FIG. 4.

The broken lines are for the purpose of illustrating structure and form no part of the claimed design.

1 Claim, 8 Drawing Sheets

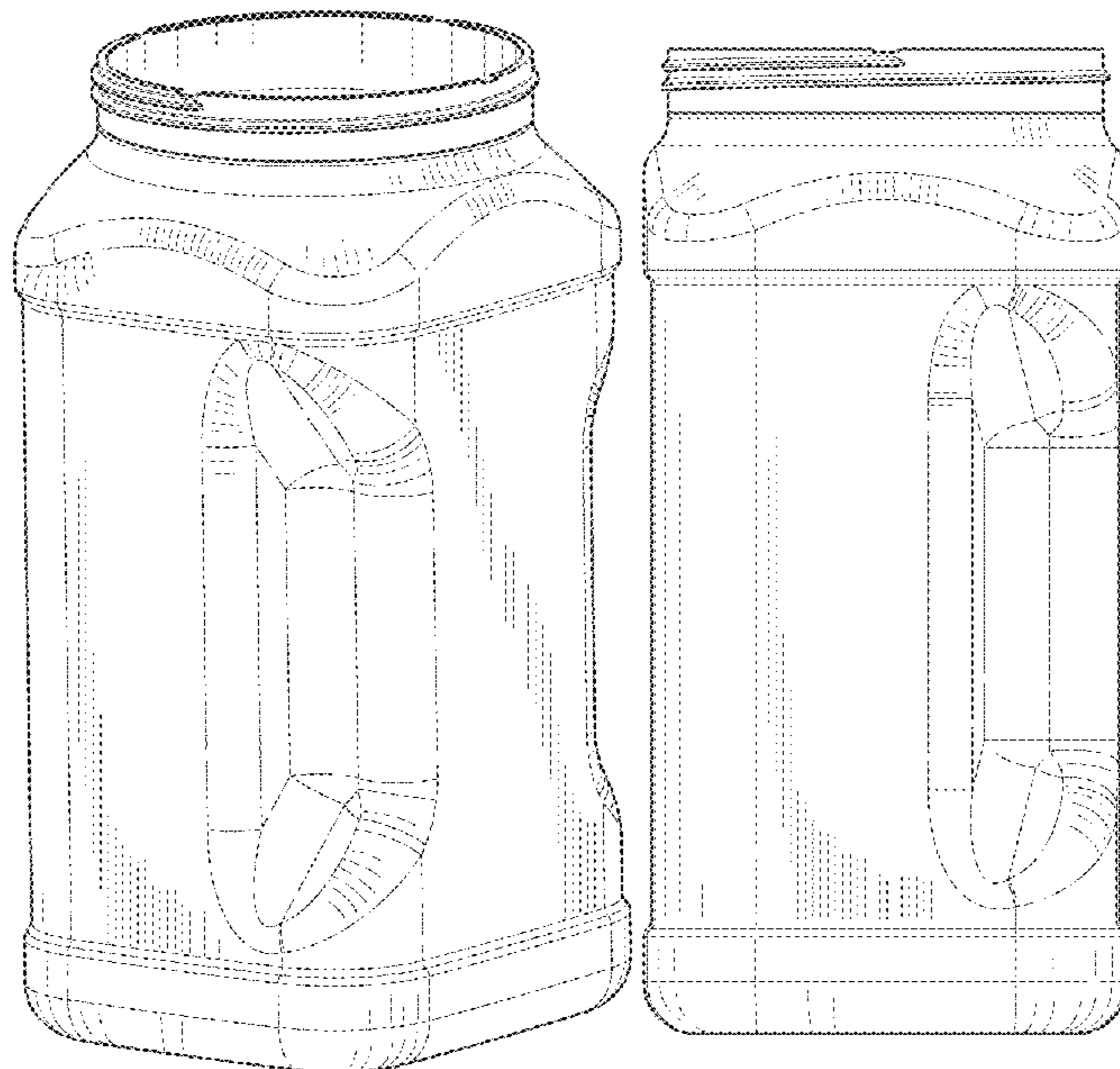

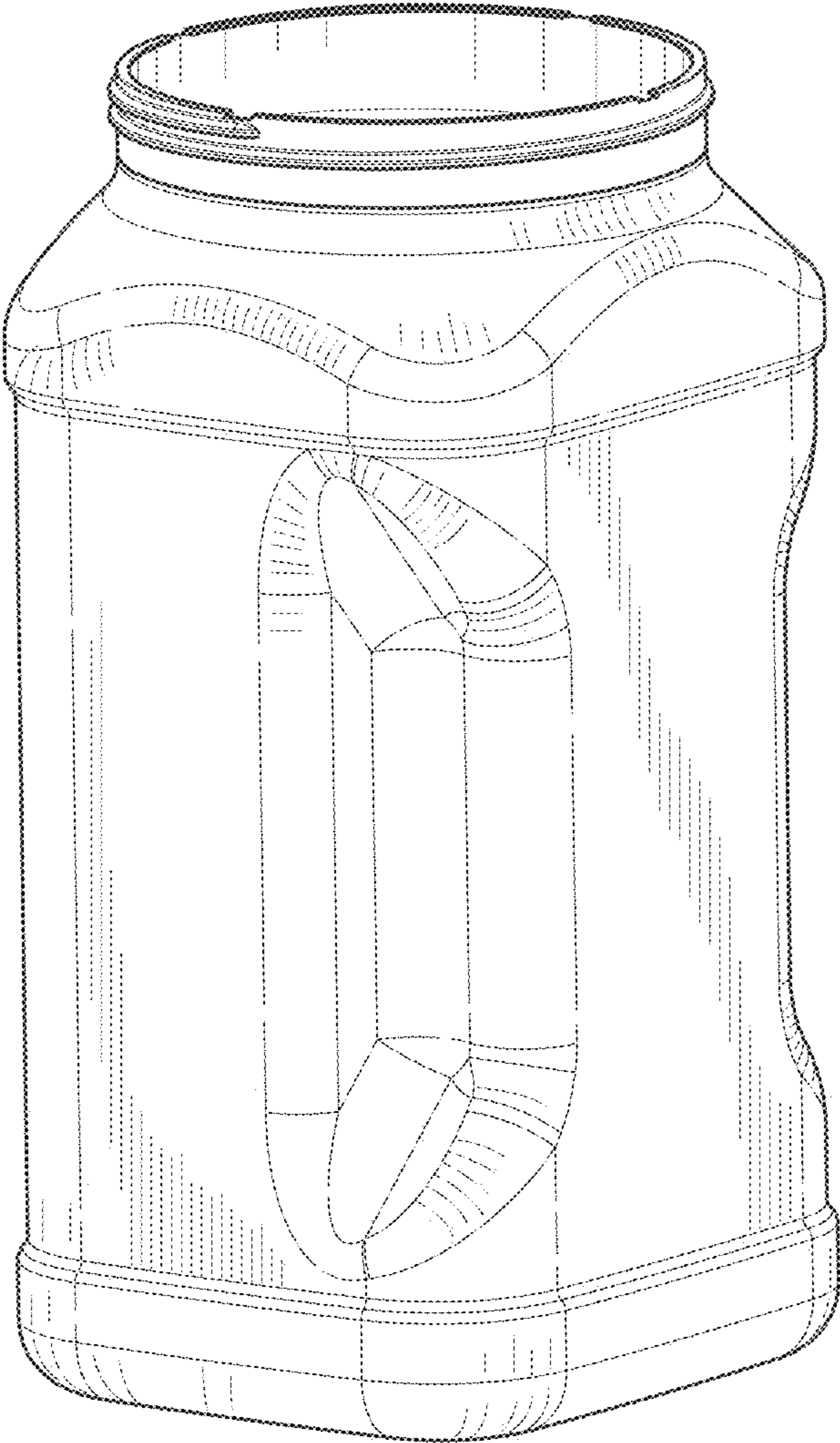

FIG. 1

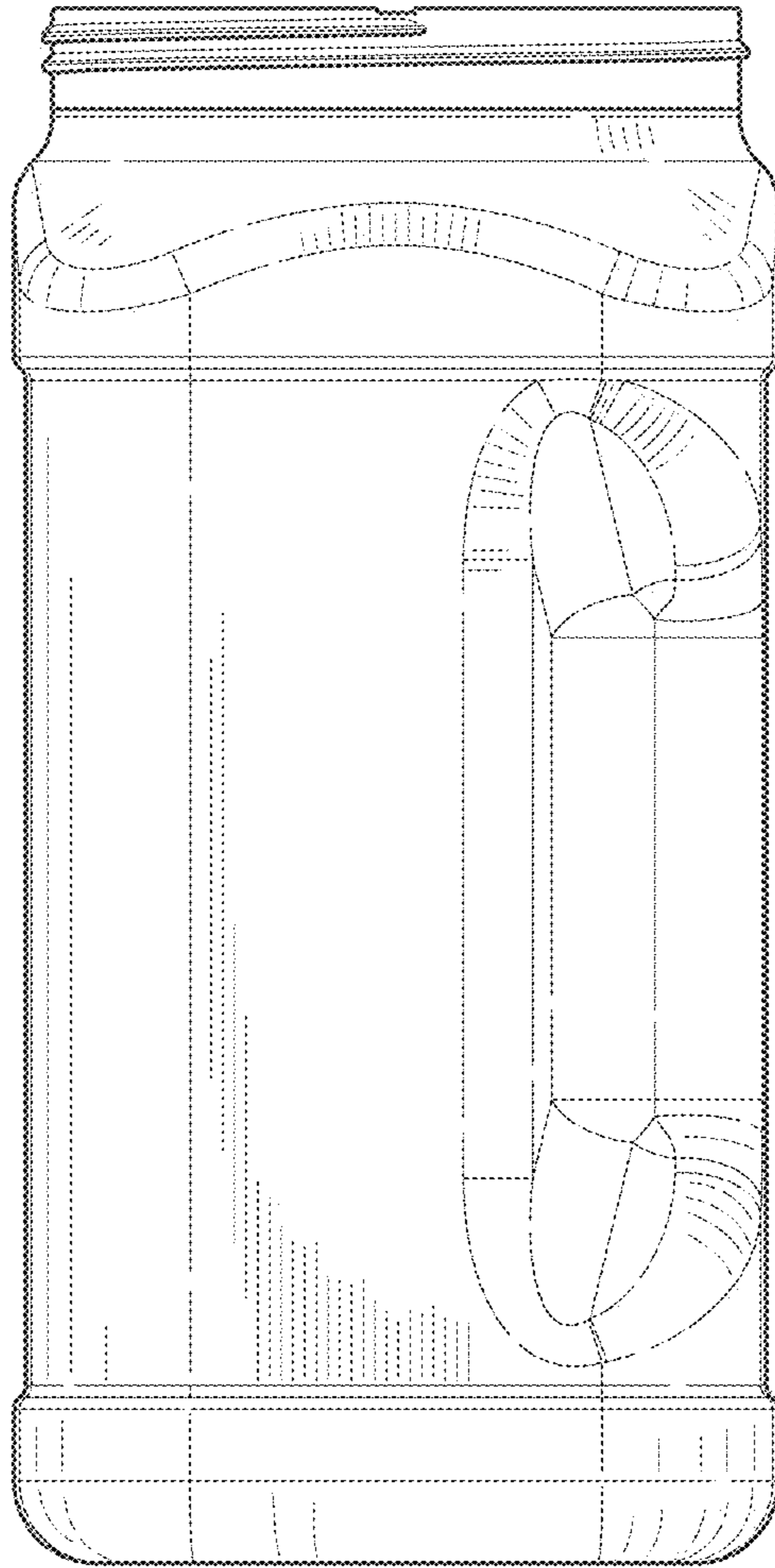

FIG. 2

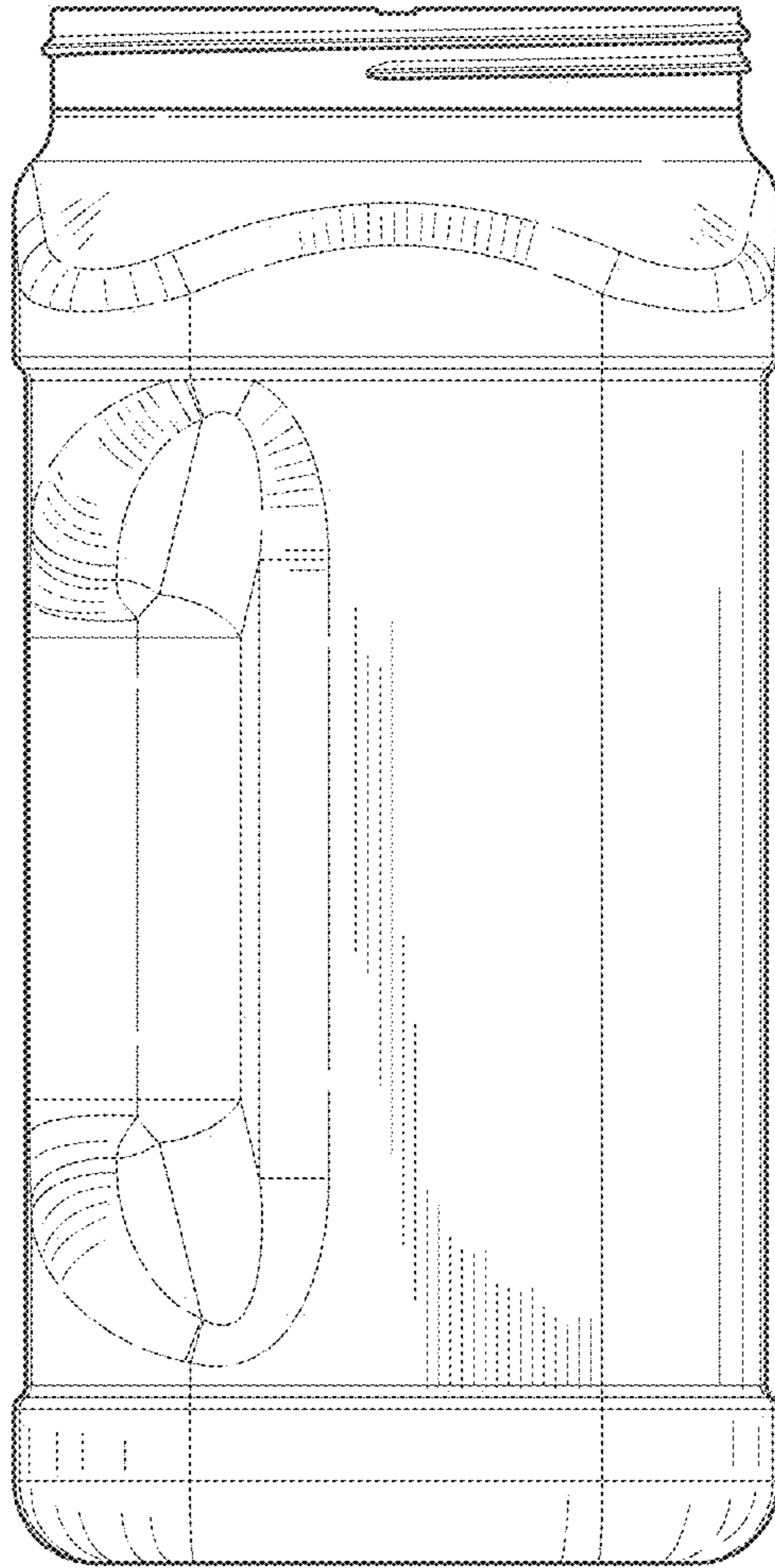

FIG. 3

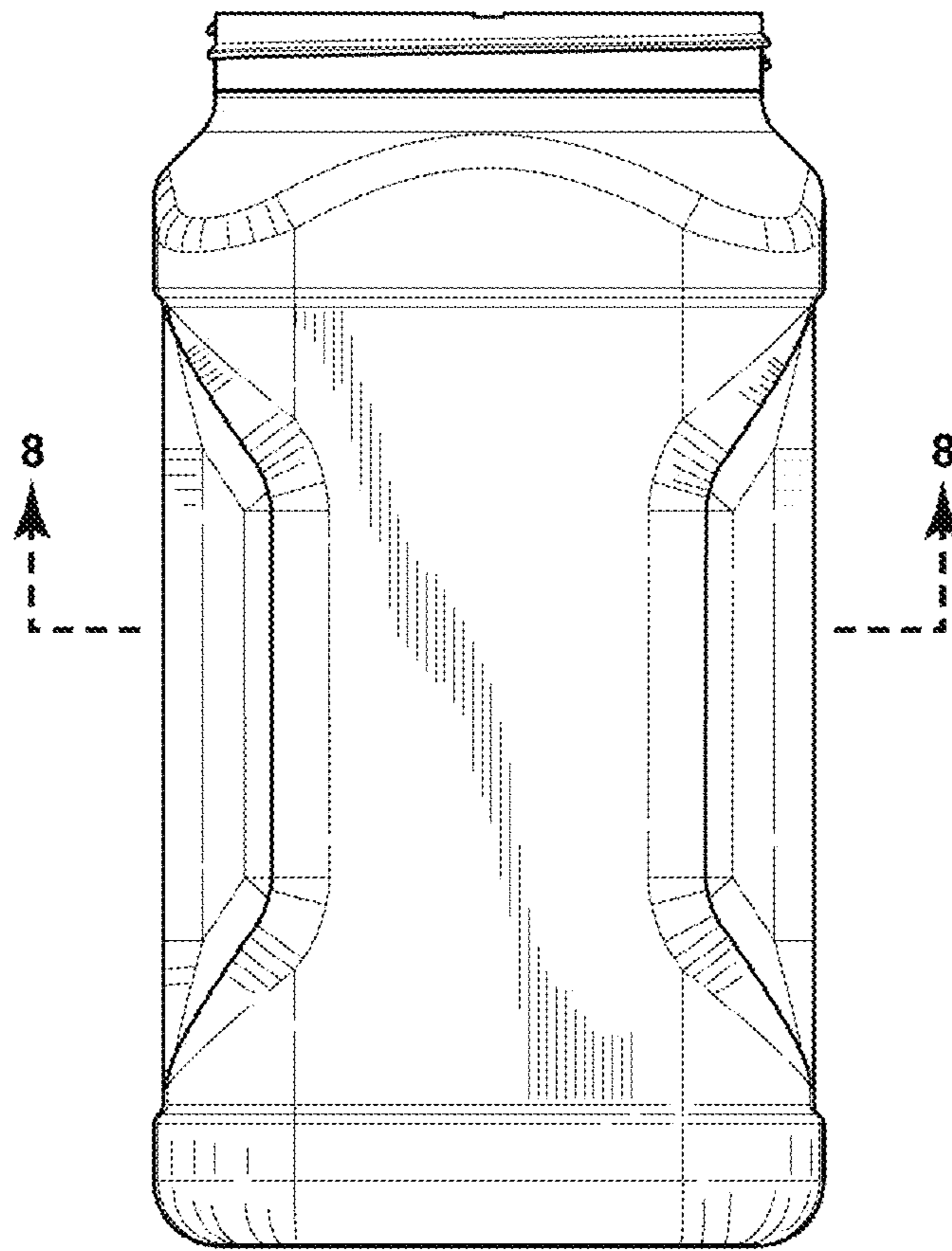

FIG. 4

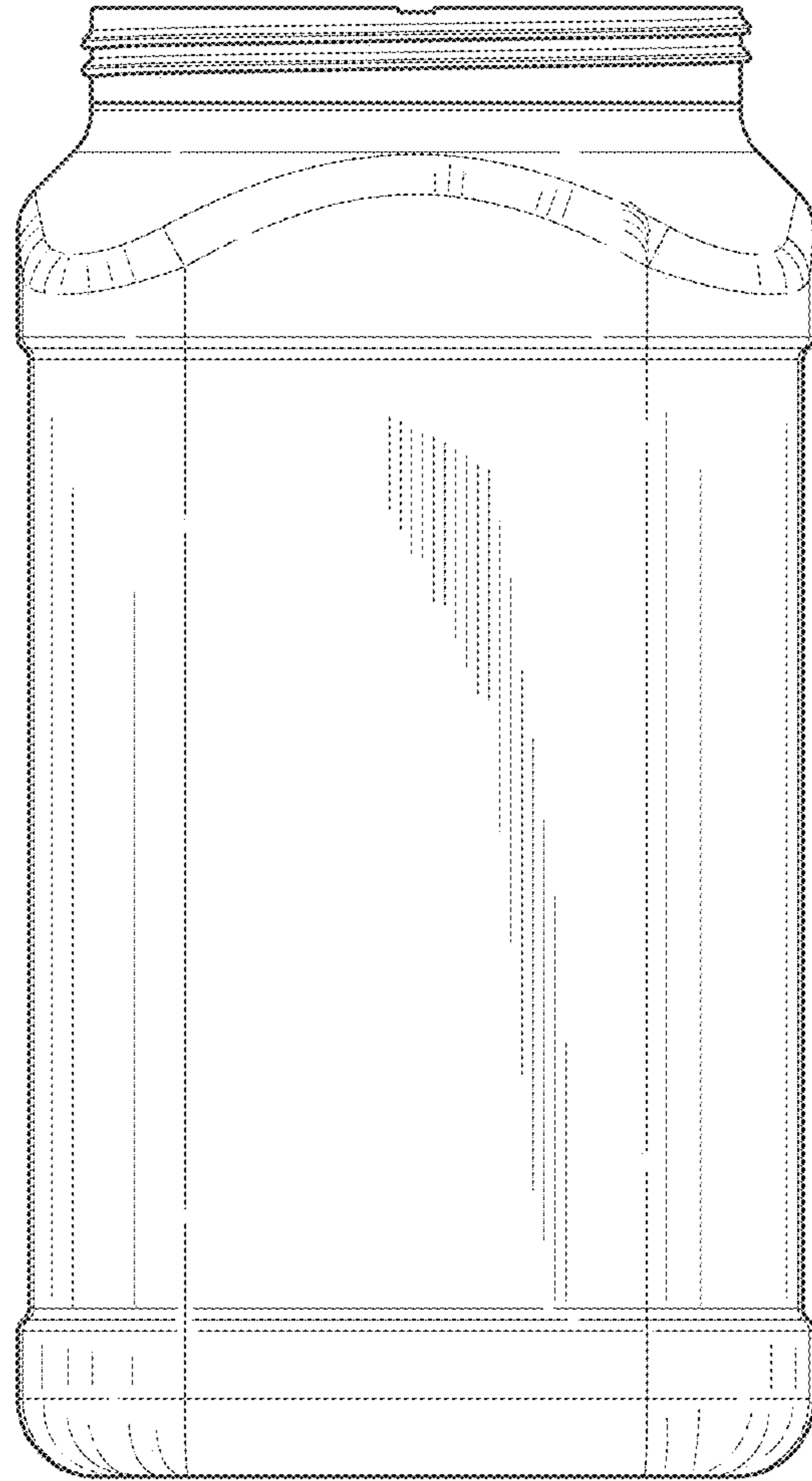

FIG. 5

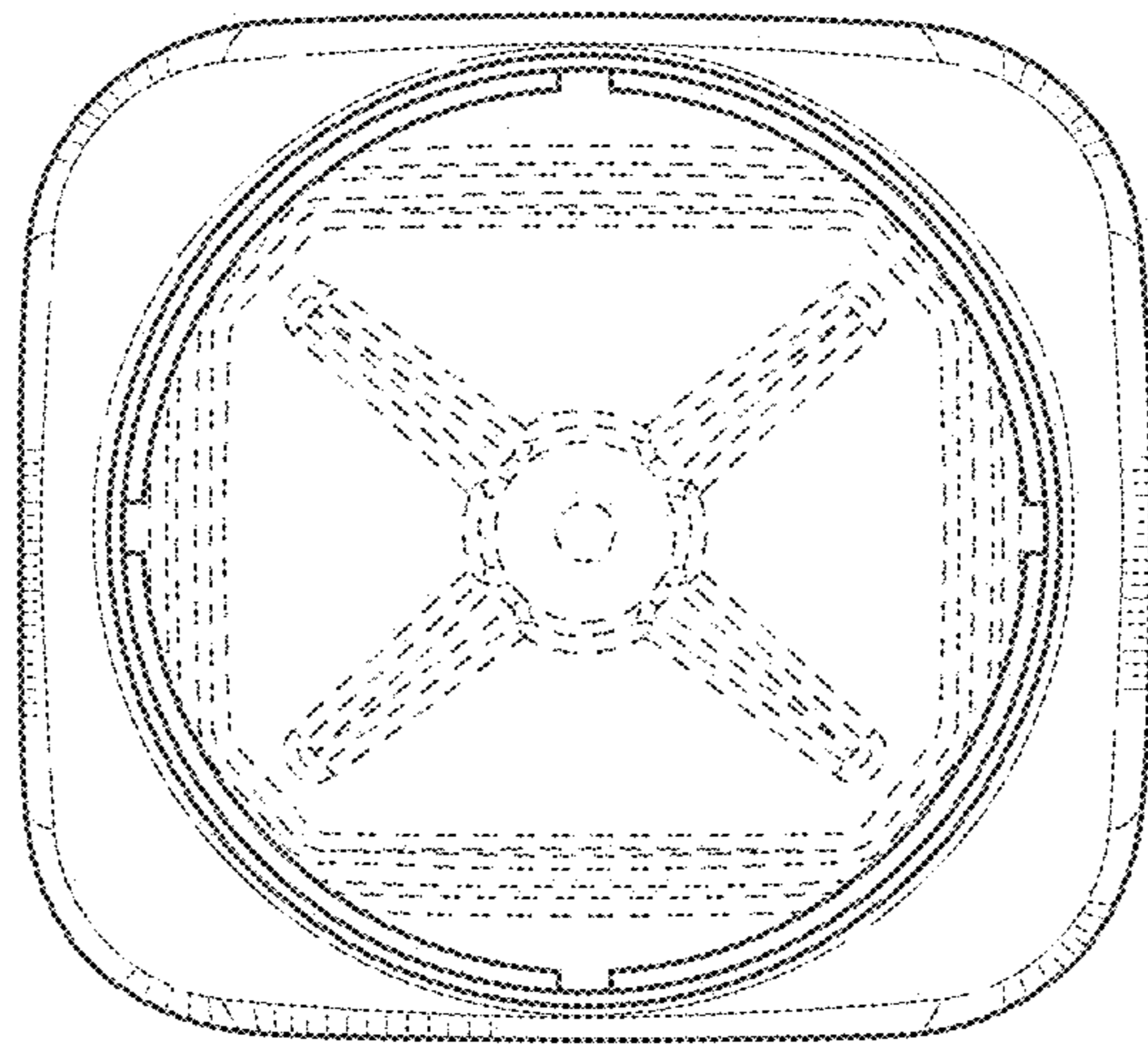

FIG. 6

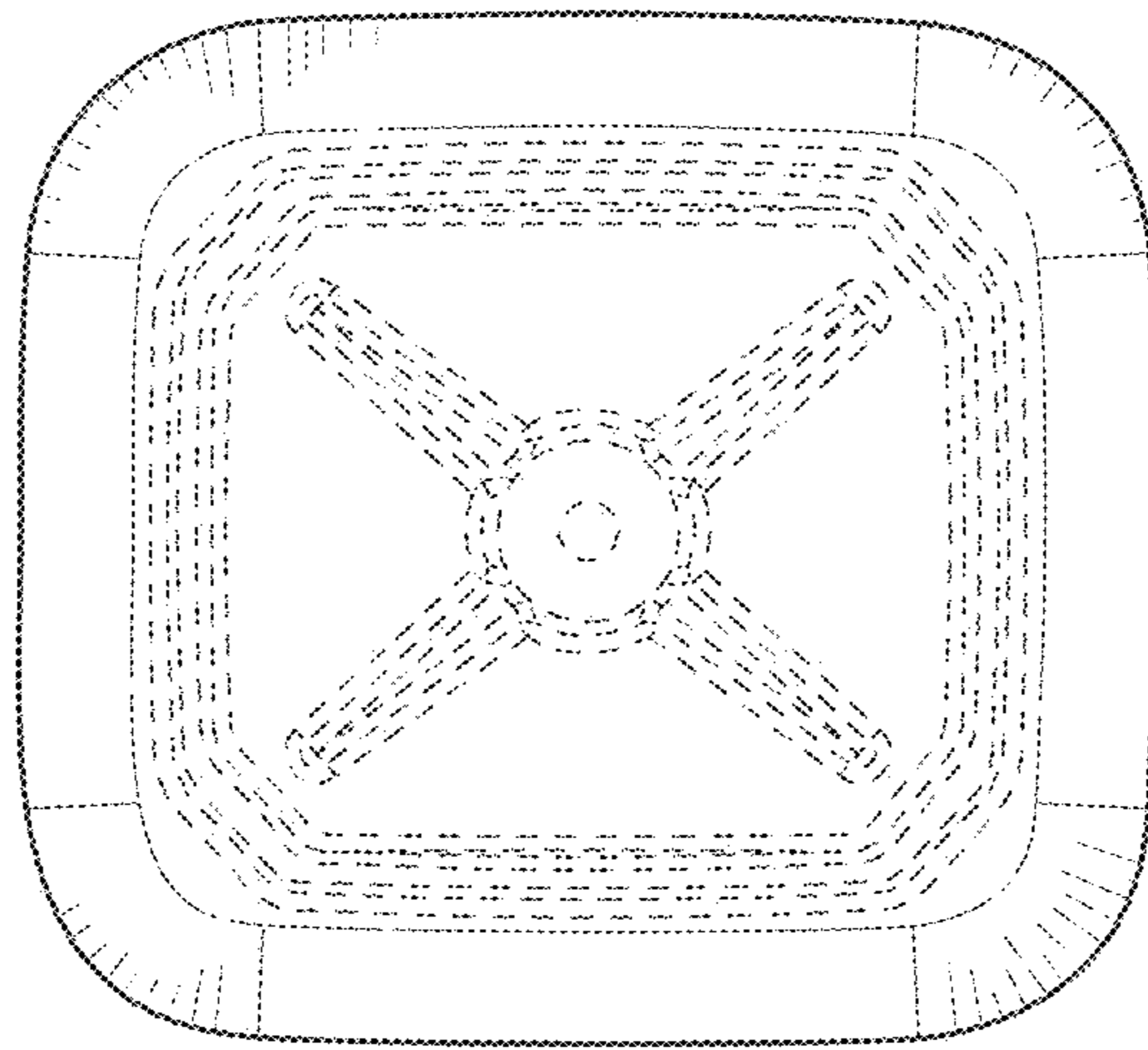

FIG. 7

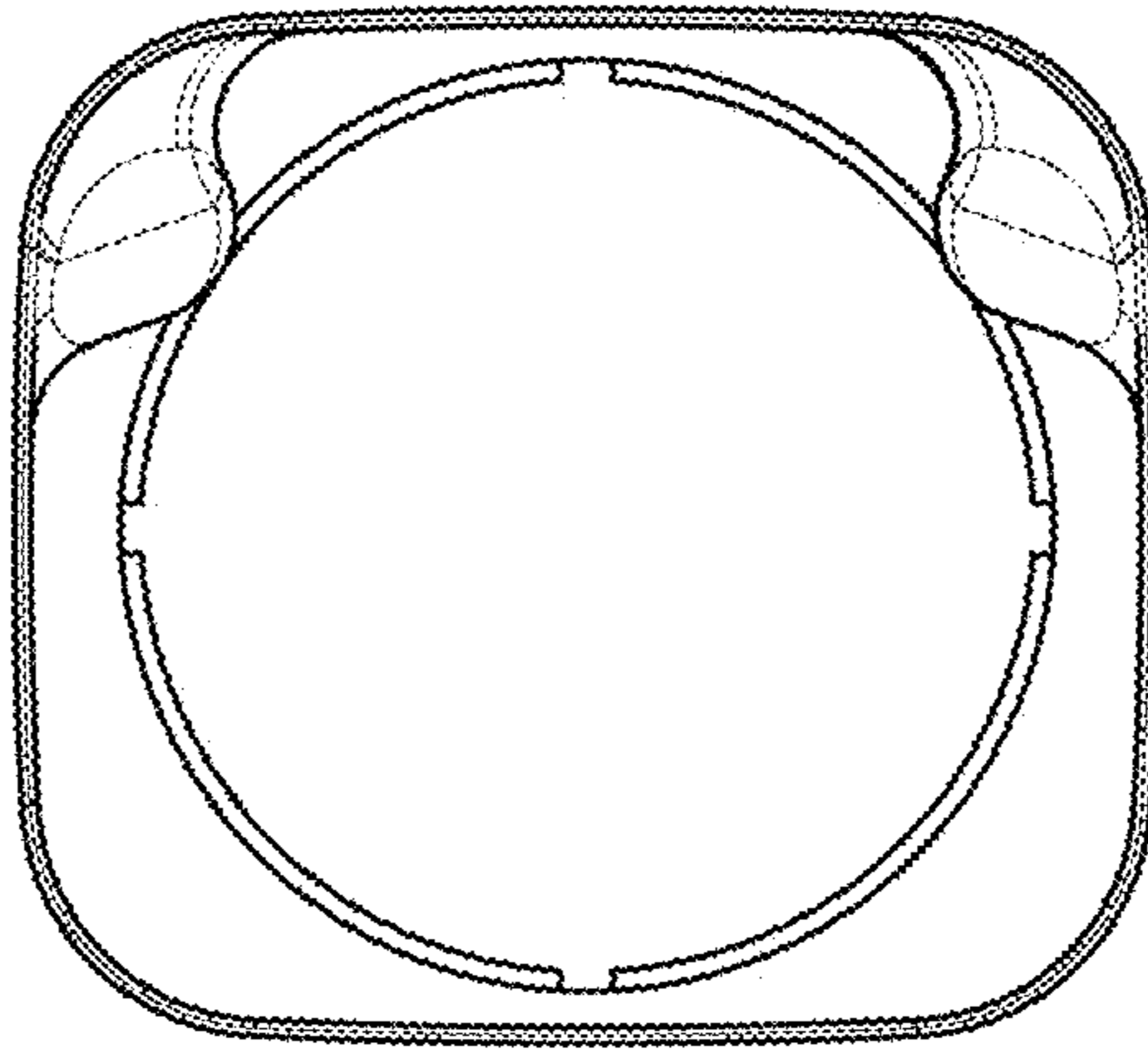

FIG. 8