



US00D924682S

(12) **United States Design Patent** (10) **Patent No.:** **US D924,682 S**
Kondo et al. (45) **Date of Patent:** **** Jul. 13, 2021**

(54) **PACKAGE WITH SURFACE ORNAMENTATION**

FOREIGN PATENT DOCUMENTS

(71) Applicant: **Otsuka Pharmaceutical Factory, Inc.**,
Tokushima (JP)

KR 3009210330000 S 8/2017
TW D101121 S 11/2004
(Continued)

(72) Inventors: **Yasunori Kondo**, Tokushima (JP);
Hiroki Otsubo, Tokyo (JP)

OTHER PUBLICATIONS

(73) Assignee: **OTSUKA PHARMACEUTICAL FACTORY, INC.**, Tokushima (JP)

Otsuka Pharmaceutical Factory. Products. No date specified, <https://www.otsukakj.jp/en/healthcare/> (Year: 0).*
(Continued)

(**) Term: **15 Years**

Primary Examiner — Darcey E Gottschalk

(21) Appl. No.: **35/509,023**

(74) *Attorney, Agent, or Firm* — Leydig Voit & Mayer, Ltd.

(22) Filed: **Oct. 10, 2019**

(57) **CLAIM**

(80) **Hague Agreement Data**

The ornamental design for a package with surface ornamentation, as shown and described.

Int. Filing Date: **Oct. 10, 2019**

DESCRIPTION

Int. Reg. No.: **DM/206519**

Int. Reg. Date: **Oct. 10, 2019**

Int. Reg. Pub. Date: **Apr. 10, 2020**

The patent or application file contains at least one drawing executed in color. Copies of this patent or patent application publication with color drawing(s) will be provided by the Office upon request and payment of the necessary fee.

(30) **Foreign Application Priority Data**

Apr. 12, 2019 (JP) 2019-008036
Apr. 12, 2019 (JP) 2019-008037
Apr. 12, 2019 (JP) 2019-008038

1.-3. Package with surface ornamentation

(51) **LOC (13) Cl.** **09-07**

(52) **U.S. Cl.**
USPC **D9/434; D9/499**

1.1 : Perspective
1.2 : Front
1.3 : Back
1.4 : Top
1.5 : Bottom
1.6 : Left
1.7 : Right

(58) **Field of Classification Search**
USPC D3/201, 203.1–203.3, 203.5–203.8,
D3/202–207, 212, 218, 219, 221, 222,
(Continued)

2.1 : Perspective
2.2 : Front
2.3 : Back
2.4 : Top
2.5 : Bottom
2.6 : Left
2.7 : Right

(56) **References Cited**

U.S. PATENT DOCUMENTS

D53,723 S * 8/1919 Wilkins D9/713
D362,367 S * 9/1995 Olsson D6/632
(Continued)

3.1 : Perspective
3.2 : Front
3.3 : Back

(Continued)

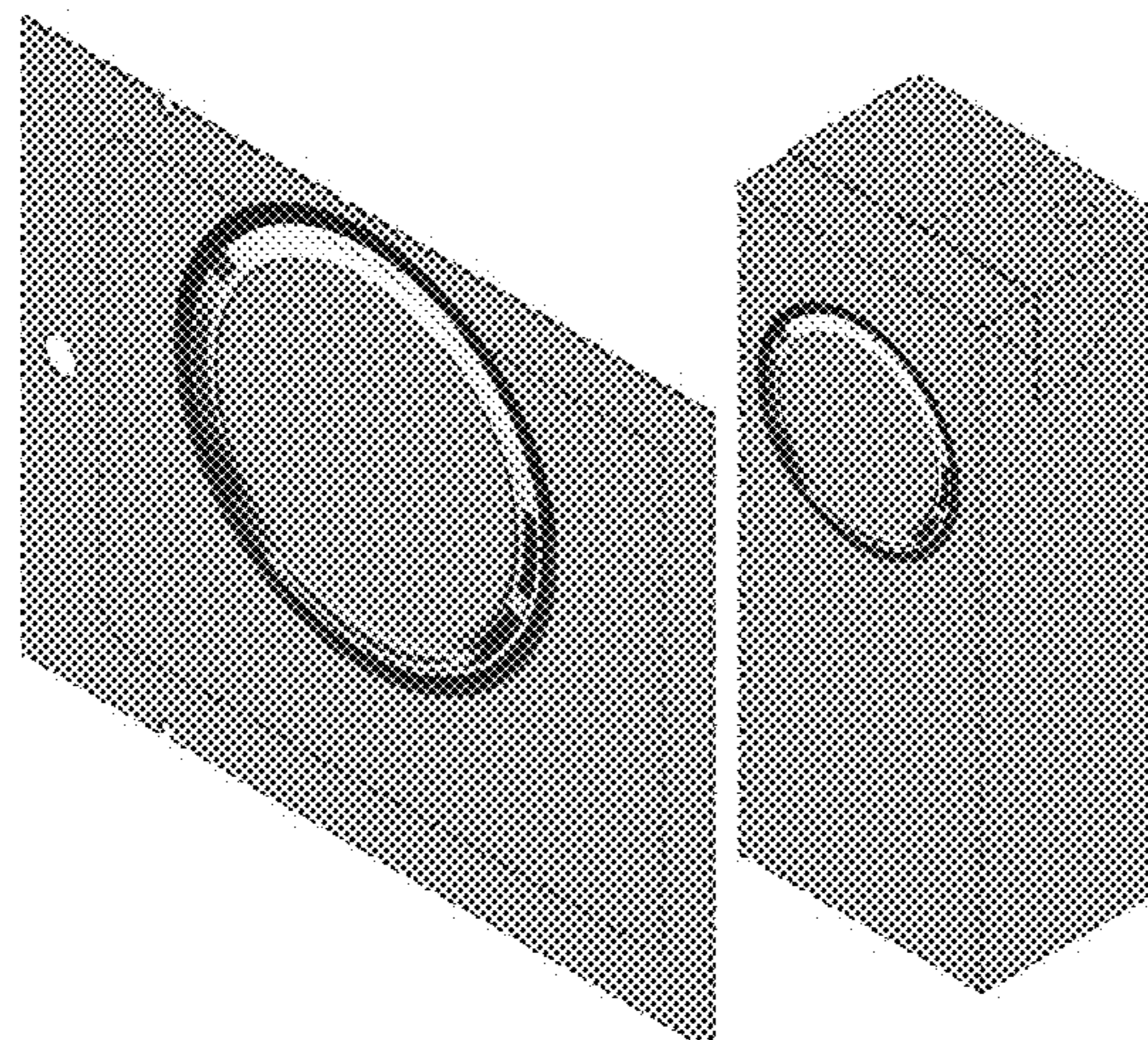

- 3.4 : Top
- 3.5 : Bottom
- 3.6 : Left
- 3.7 : Right

The parts shown in dotted lines and the parts colored by red do not form part of the claimed design.

**1 Claim, 21 Drawing Sheets
(21 of 21 Drawing Sheet(s) Filed in Color)**

(58) **Field of Classification Search**

USPC D3/225–228, 230, 232, 246, 254,
 D3/263–268, 272, 273, 281–283, 290,
 D3/291, 294; D9/414, 431–433, 499,
 D9/703, 707, 702, 711–713; D28/5
 CPC A44B 15/00; A45C 1/02; A45C 13/08;
 A45C 13/30; B65B 3/02; B65B 5/02;
 B65B 7/00; B65D 43/00; B65D 5/74

See application file for complete search history.

(56) **References Cited**

U.S. PATENT DOCUMENTS

D592,525 S *	5/2009	Maude	D27/193
D642,414 S *	8/2011	Wynalda, Jr.	D6/627
D646,918 S *	10/2011	Wynalda, Jr.	D6/632
D742,641 S *	11/2015	Koh	D3/294
D755,505 S *	5/2016	Marteau	D3/207
D790,847 S *	7/2017	Tappeiner	D3/205

D793,717 S *	8/2017	Boljat	D3/205
D798,594 S *	10/2017	Boler	D3/273
D813,031 S *	3/2018	Boston	D9/434
D840,677 S *	2/2019	Duncan	D3/207
D850,901 S *	6/2019	Kemker	D9/414
D852,620 S *	7/2019	D'Alfonso	D9/430
D859,952 S *	9/2019	Ulloa	D8/71
D861,321 S *	10/2019	Petre	D3/202
D874,127 S *	2/2020	Wang	D3/202
D883,084 S *	5/2020	Sinclair	D9/432
D891,921 S *	8/2020	Davies	D9/432
D892,493 S *	8/2020	Carson	D3/207
D896,515 S *	9/2020	Cooper	D3/273

FOREIGN PATENT DOCUMENTS

TW	D125122 S	10/2008
TW	D178104 S	9/2016
TW	D184215 S	7/2017
TW	D188628 S	2/2018
TW	D195526 S	1/2019

OTHER PUBLICATIONS

Taiwanese Patent Office, Notice of Allowance in Taiwanese Patent Application No. 108306314, dated Jul. 15, 2020.
 Taiwanese Patent Office, Notice of Allowance in Taiwanese Patent Application No. 108306314D02, dated Jul. 15, 2020.
 Taiwanese Patent Office, Notice of Allowance in counterpart Taiwanese Patent Application No. 108306314D01, dated Jul. 15, 2020.
 Taiwanese Patent Office, Notice of Allowance in Taiwanese Patent Application No. 108306314D03, dated Jul. 15, 2020.

* cited by examiner

1.1

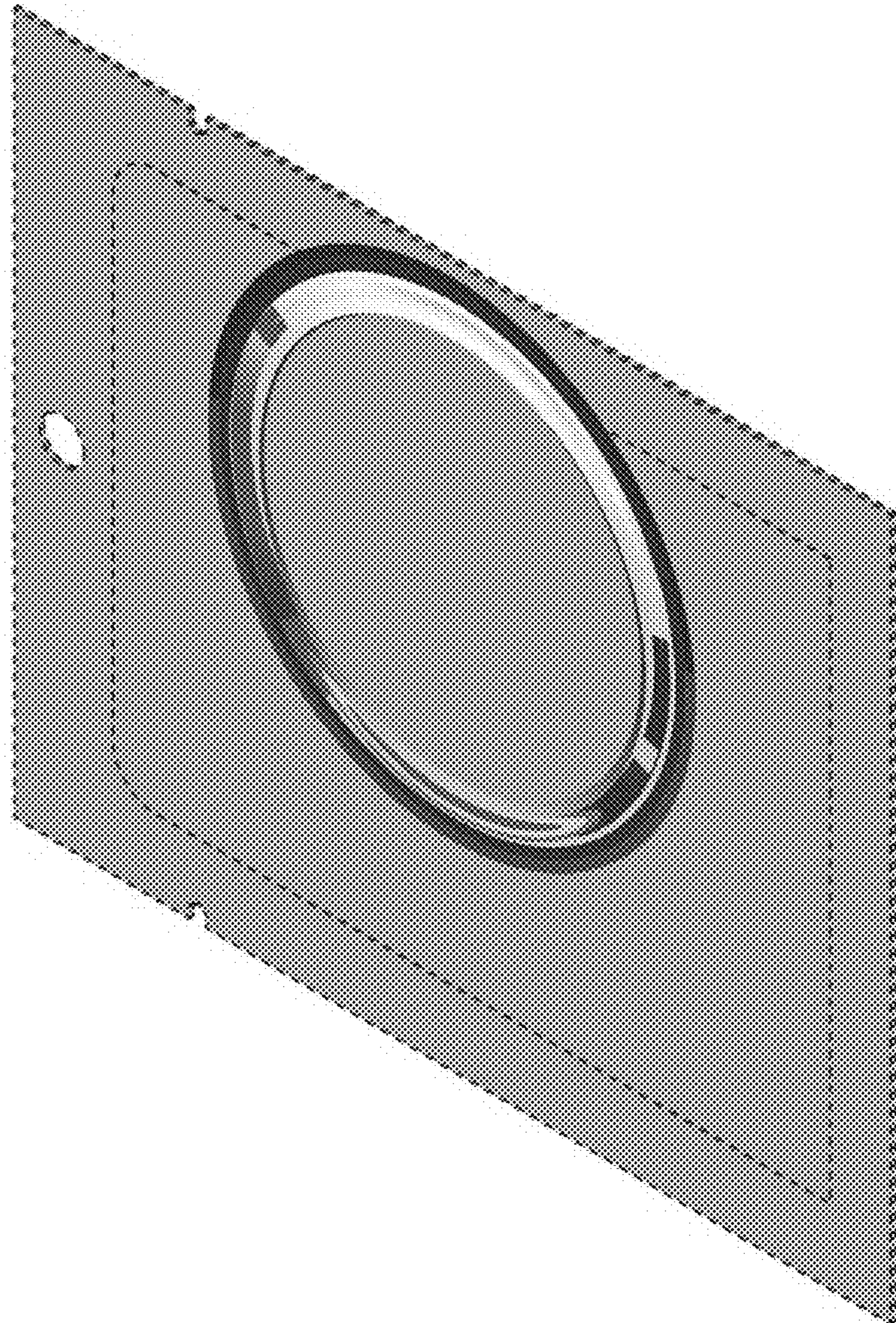

1.2

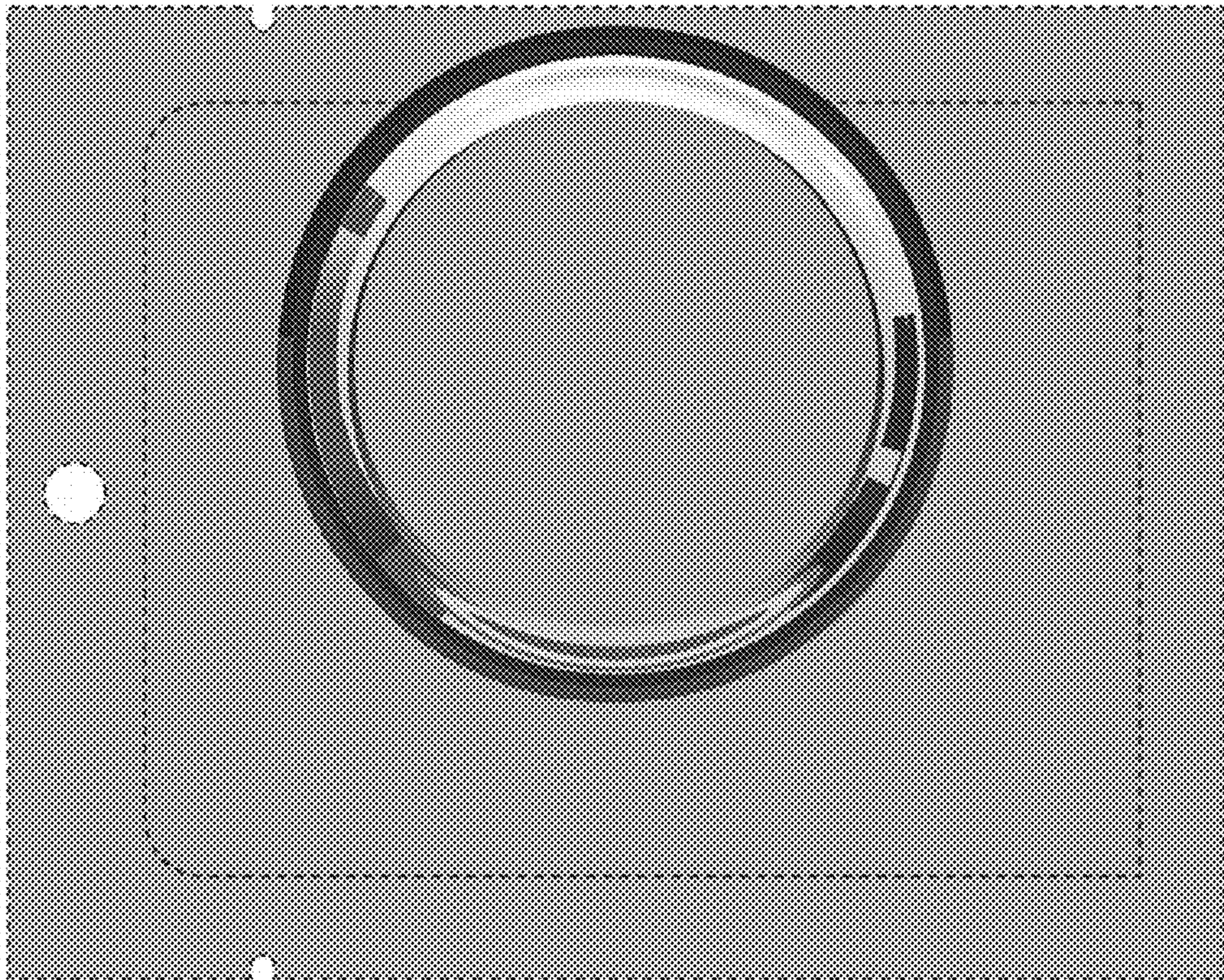

1.3



1.4



1.5



1.6



1.7



2.1

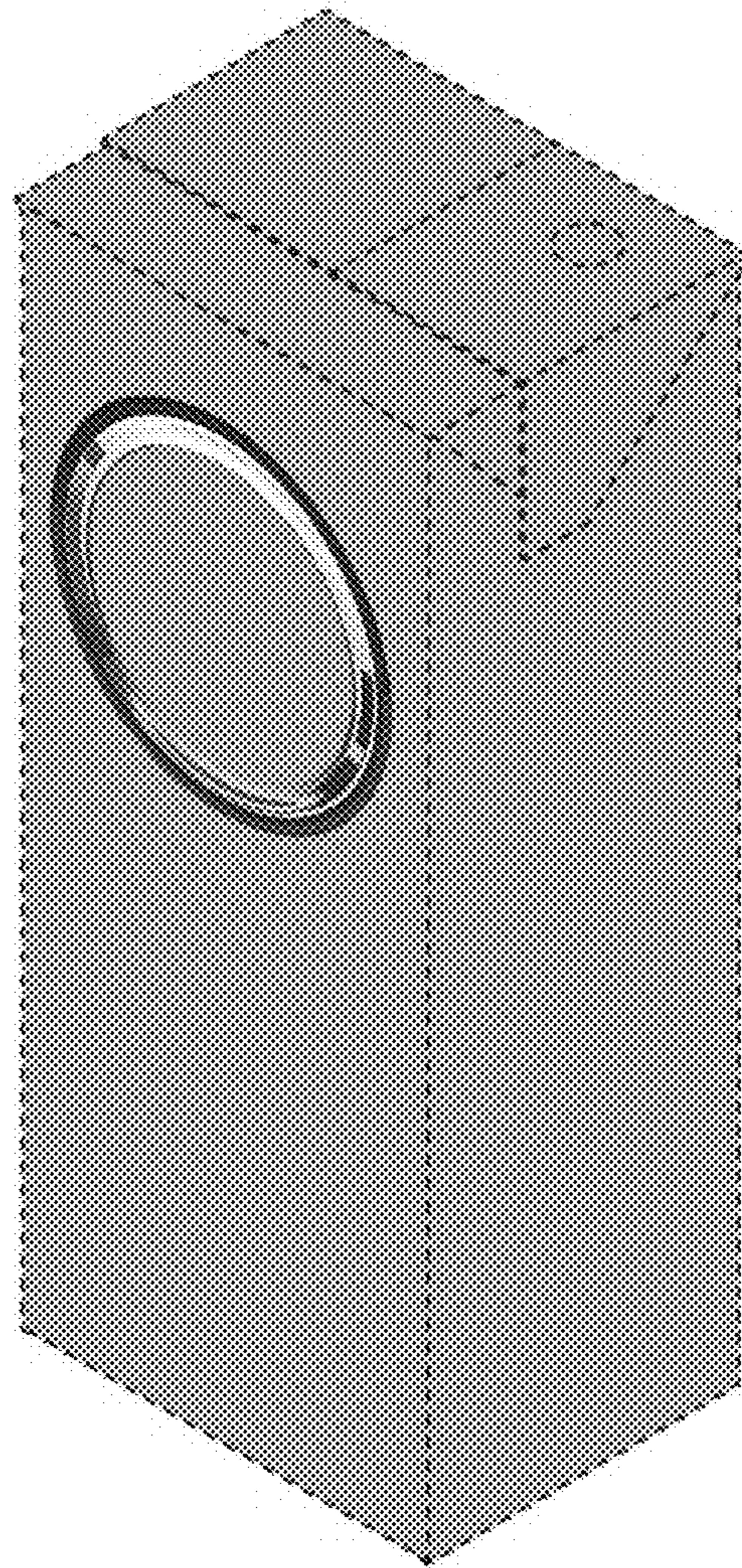

2.2

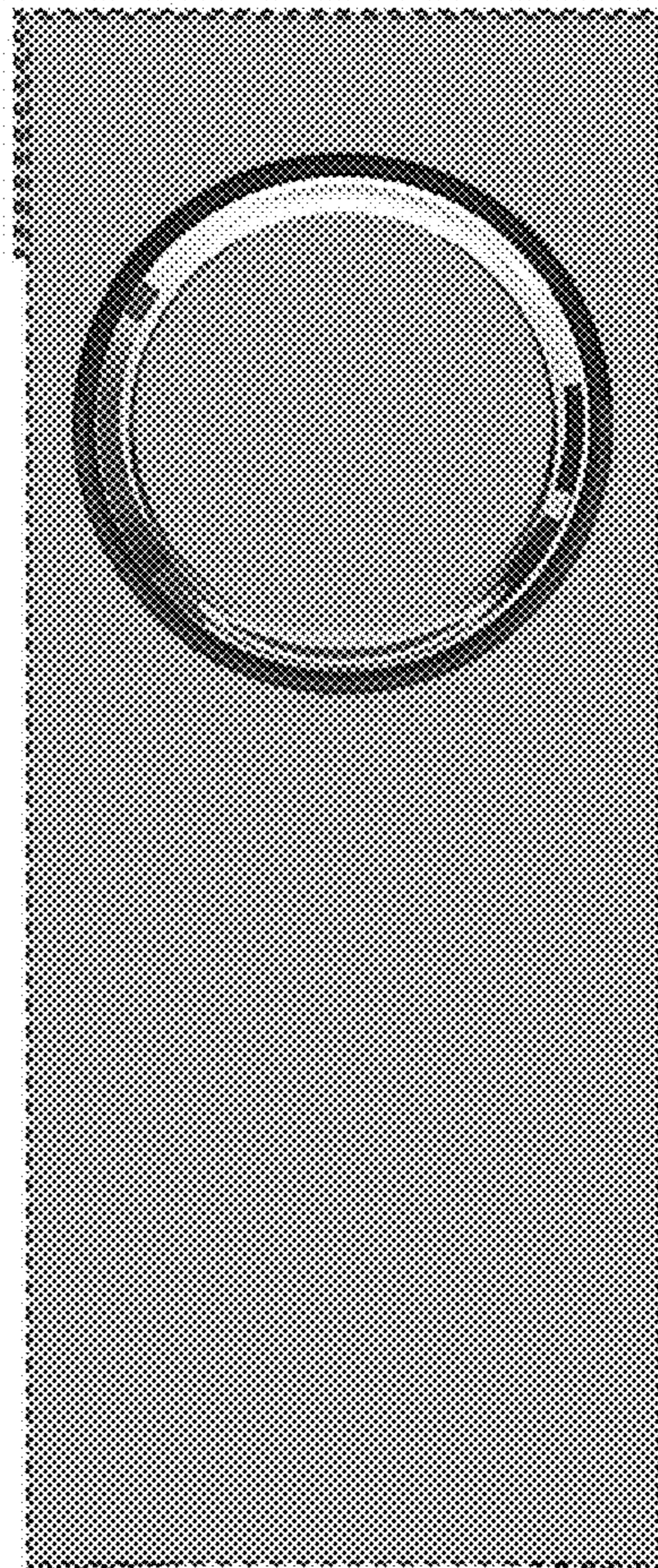

2.3

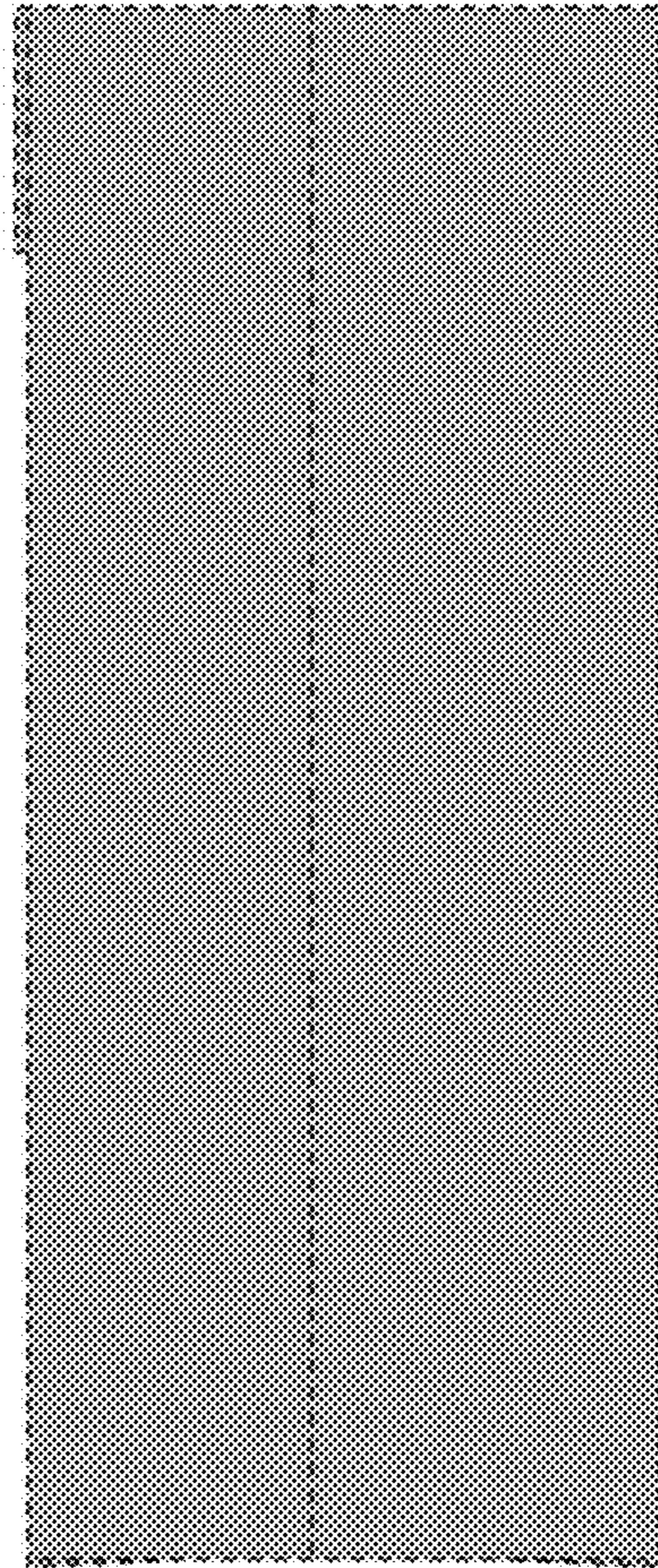

2.4

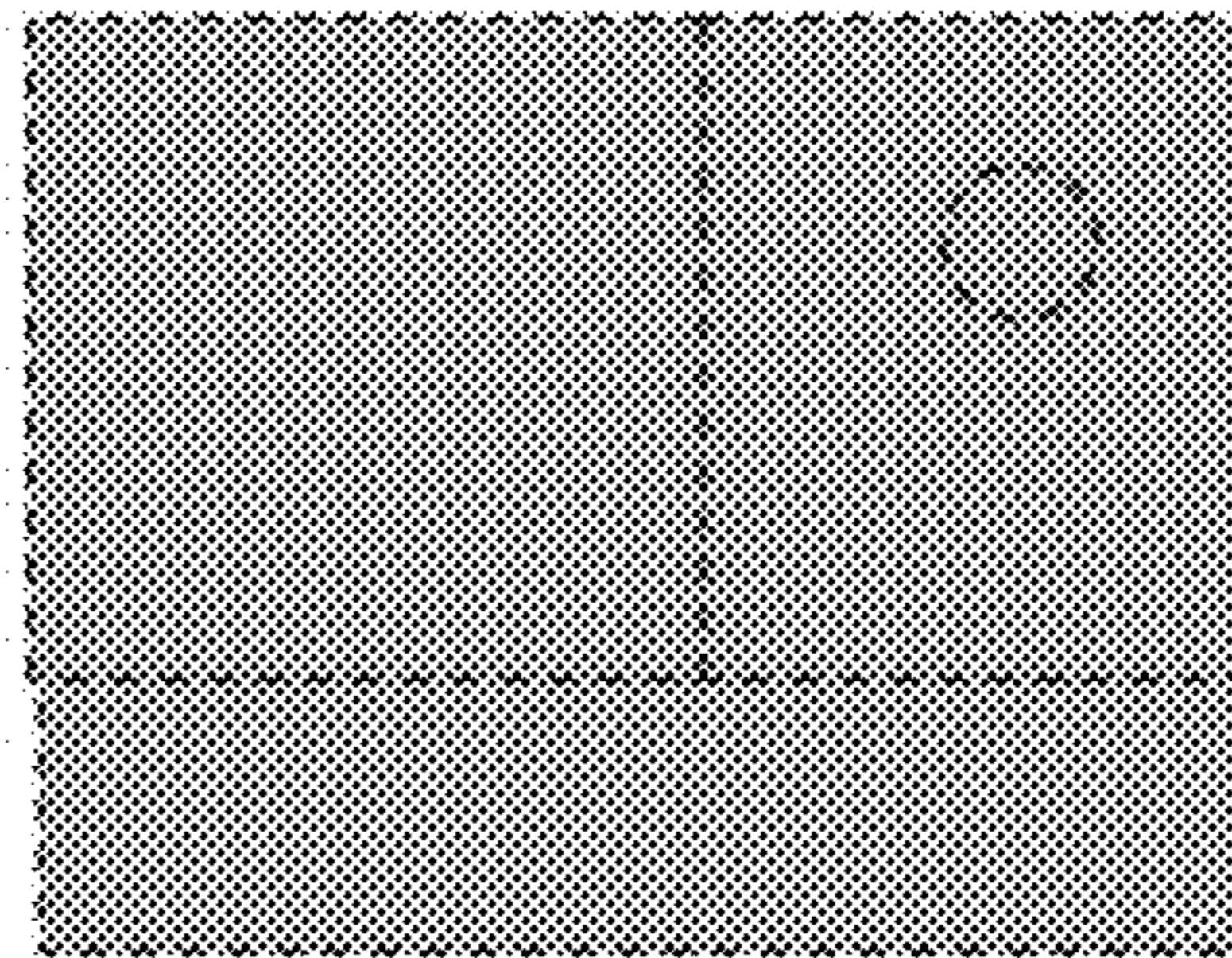

2.5

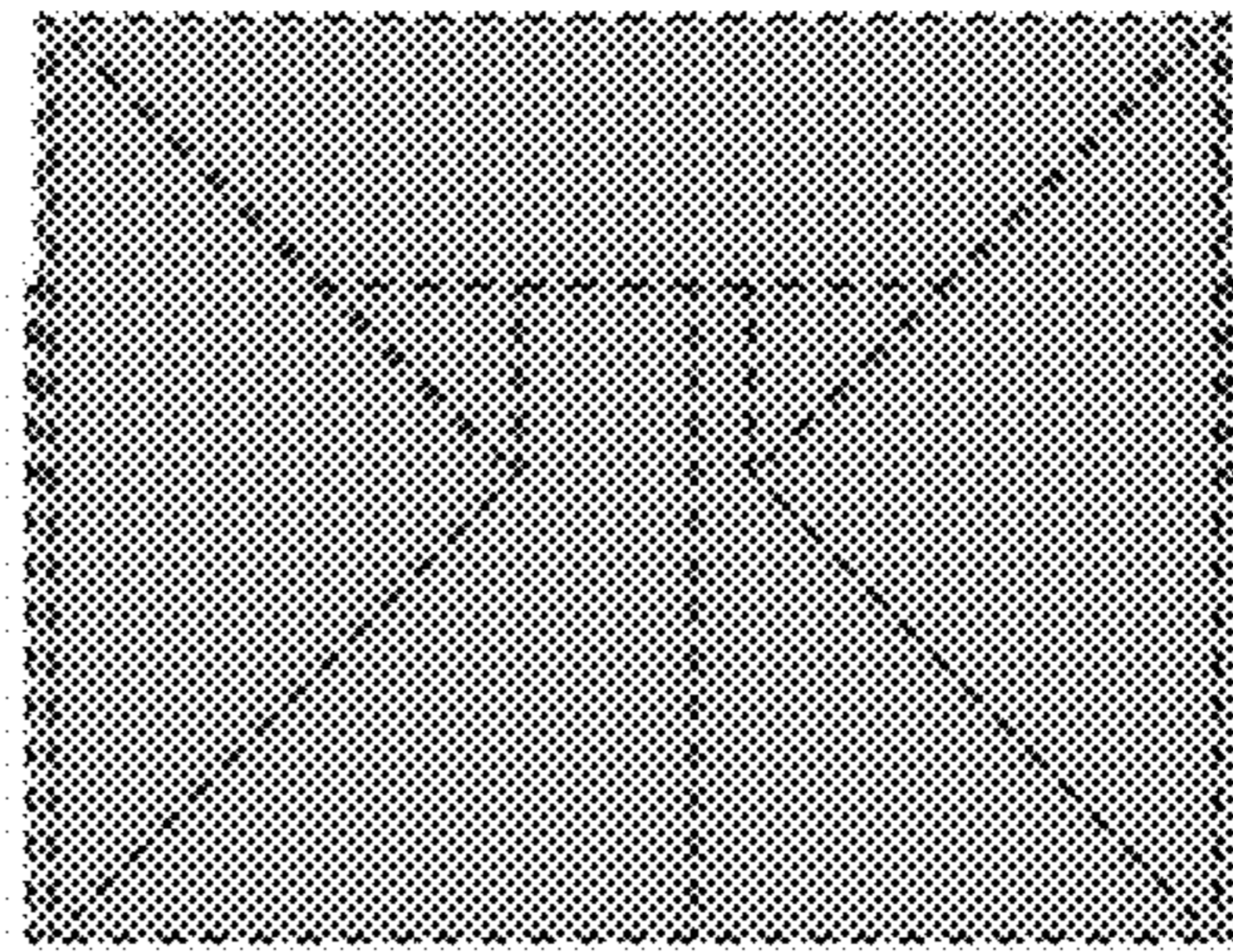

2.6

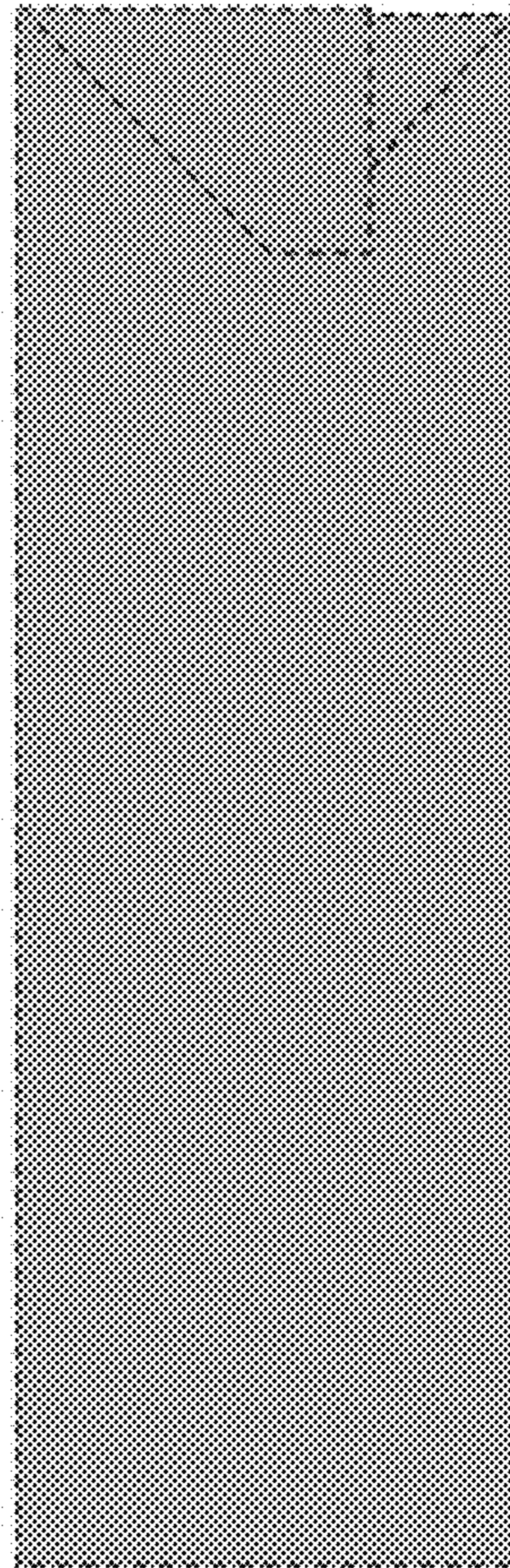

2.7

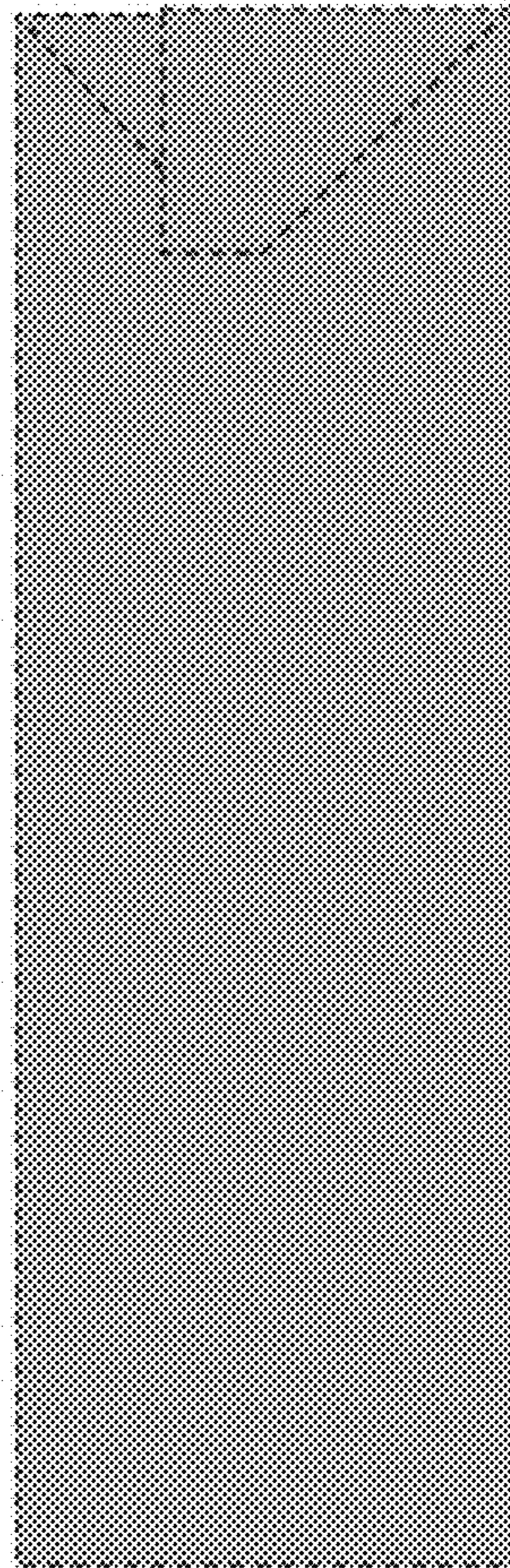

3.1

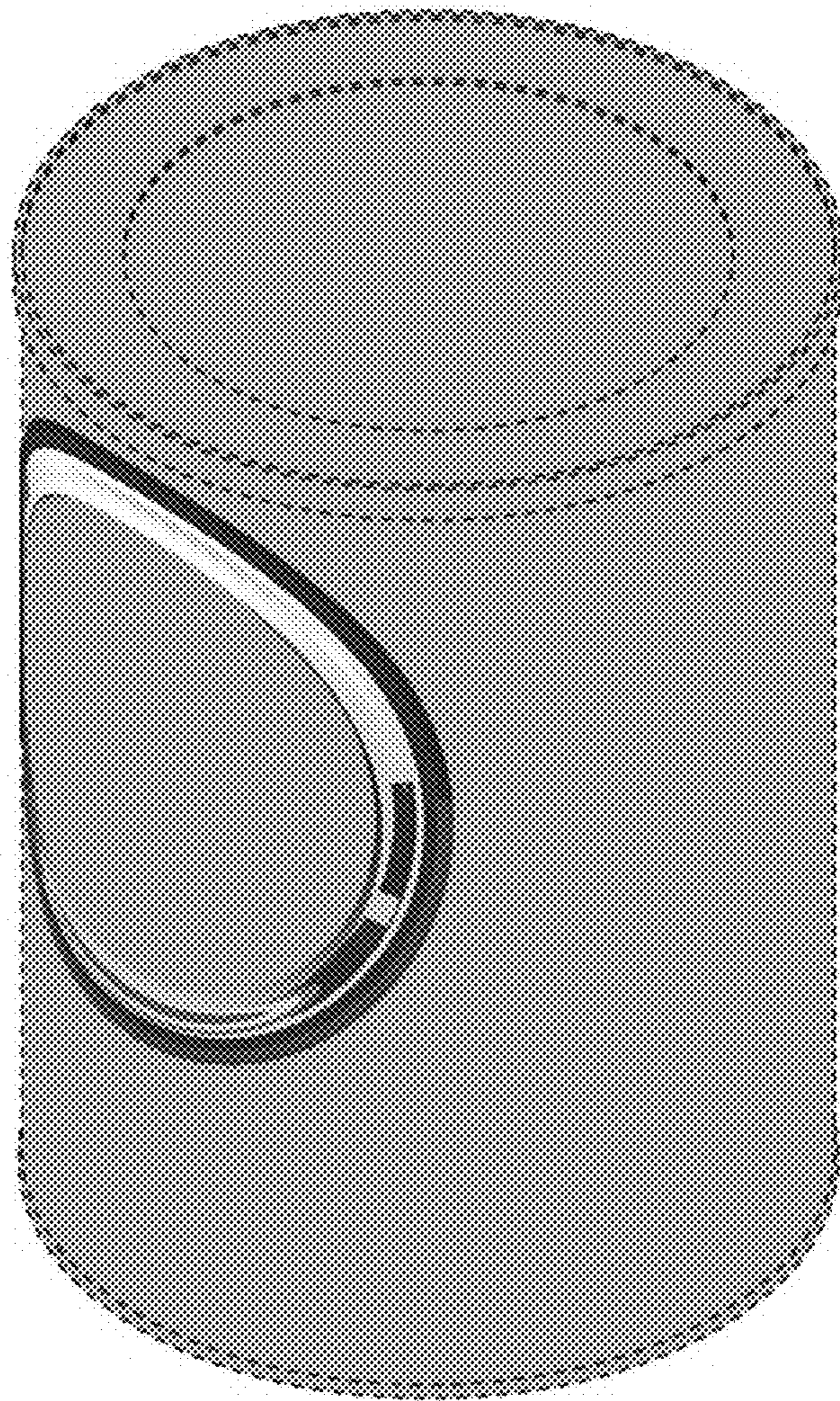

3.2

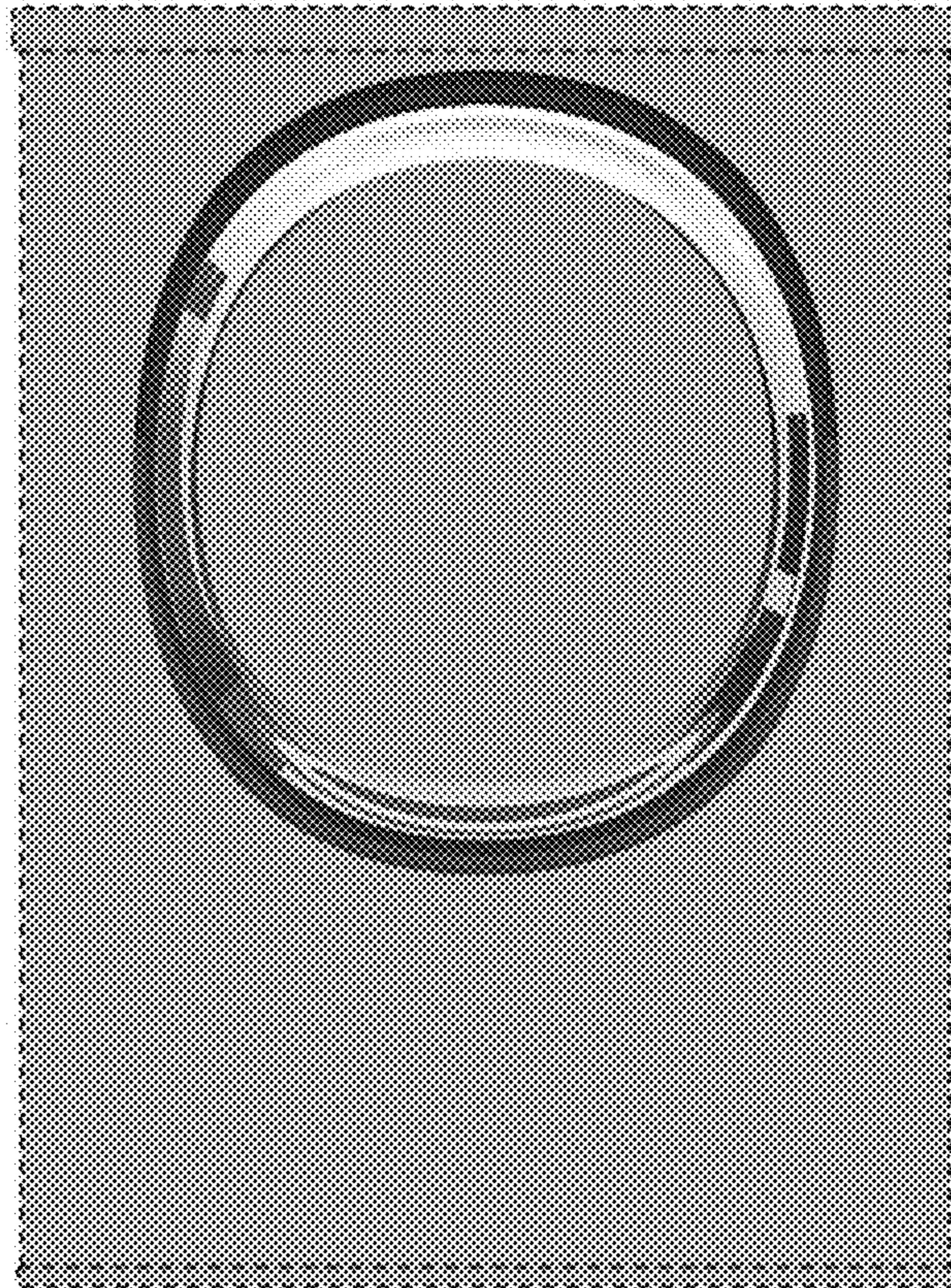

3.3

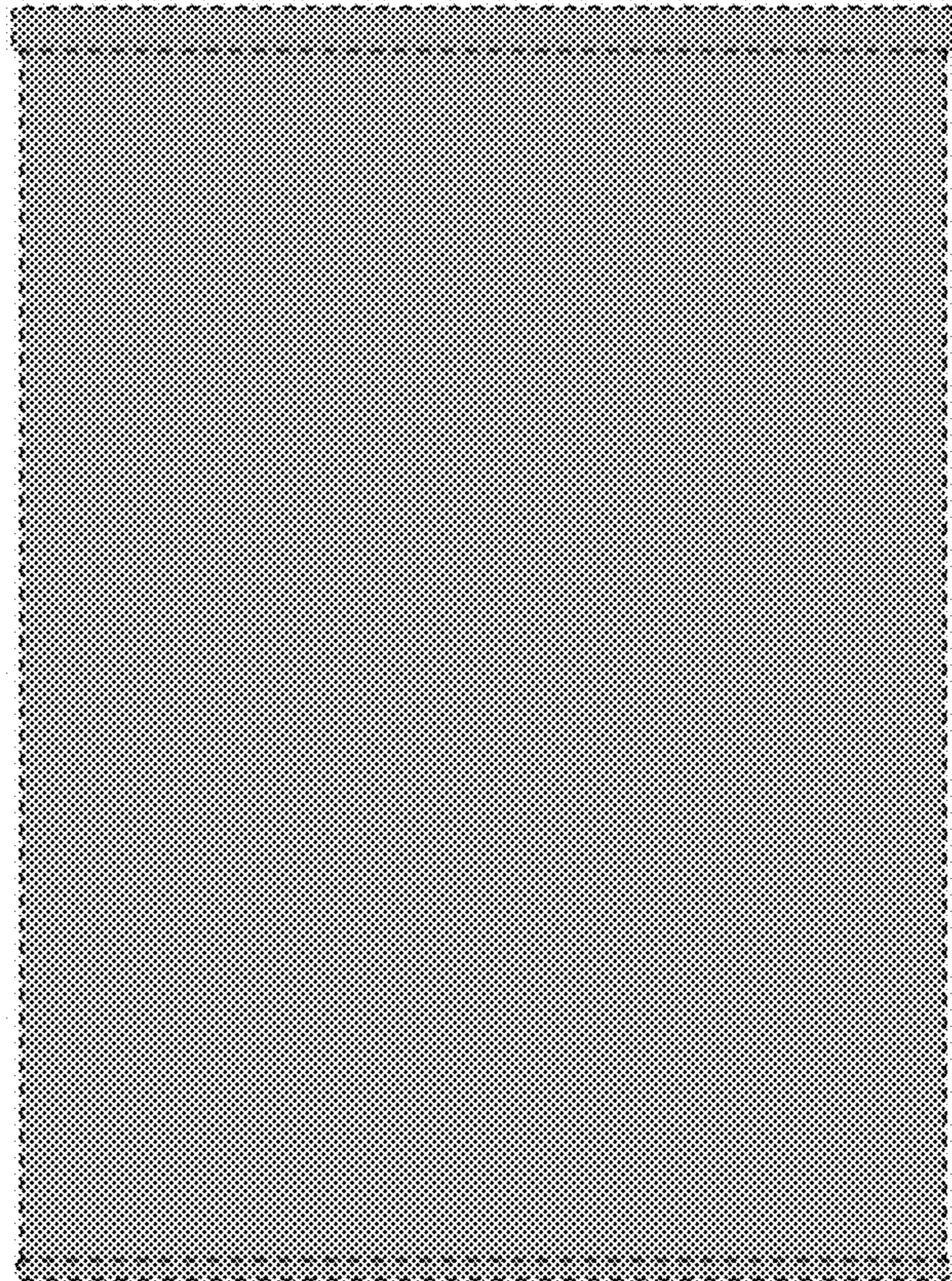

3.4

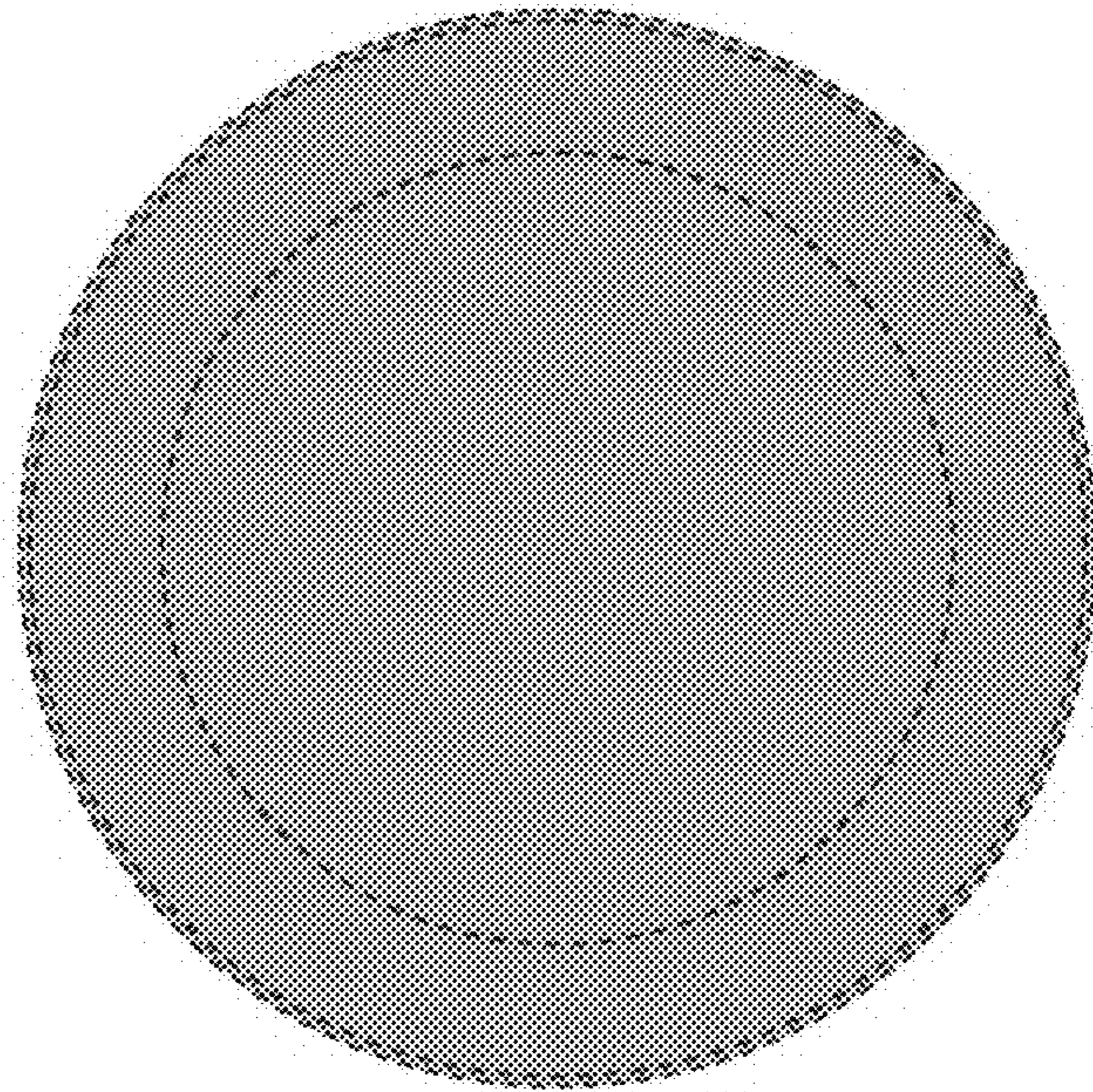

3.5

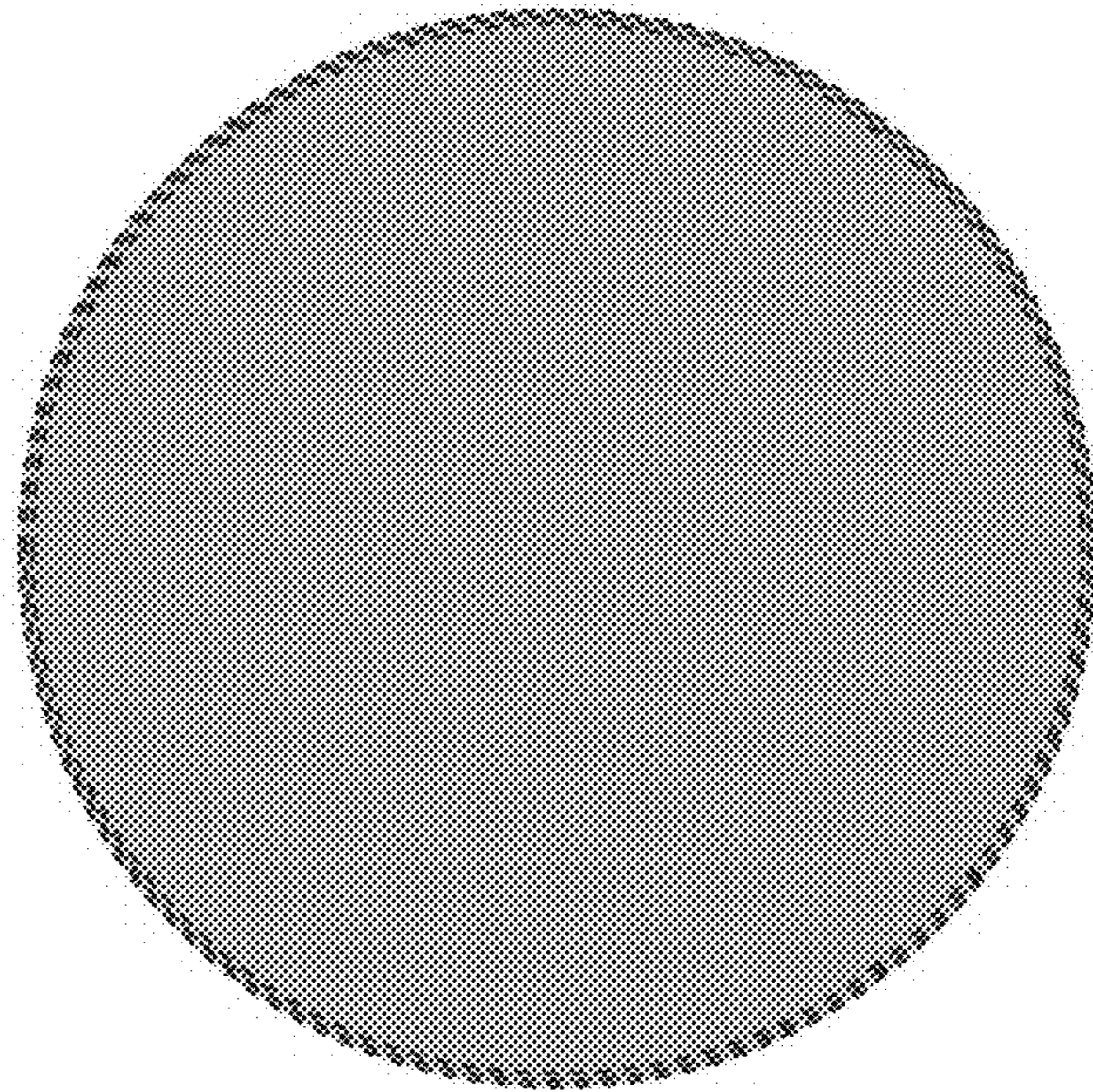

3.6

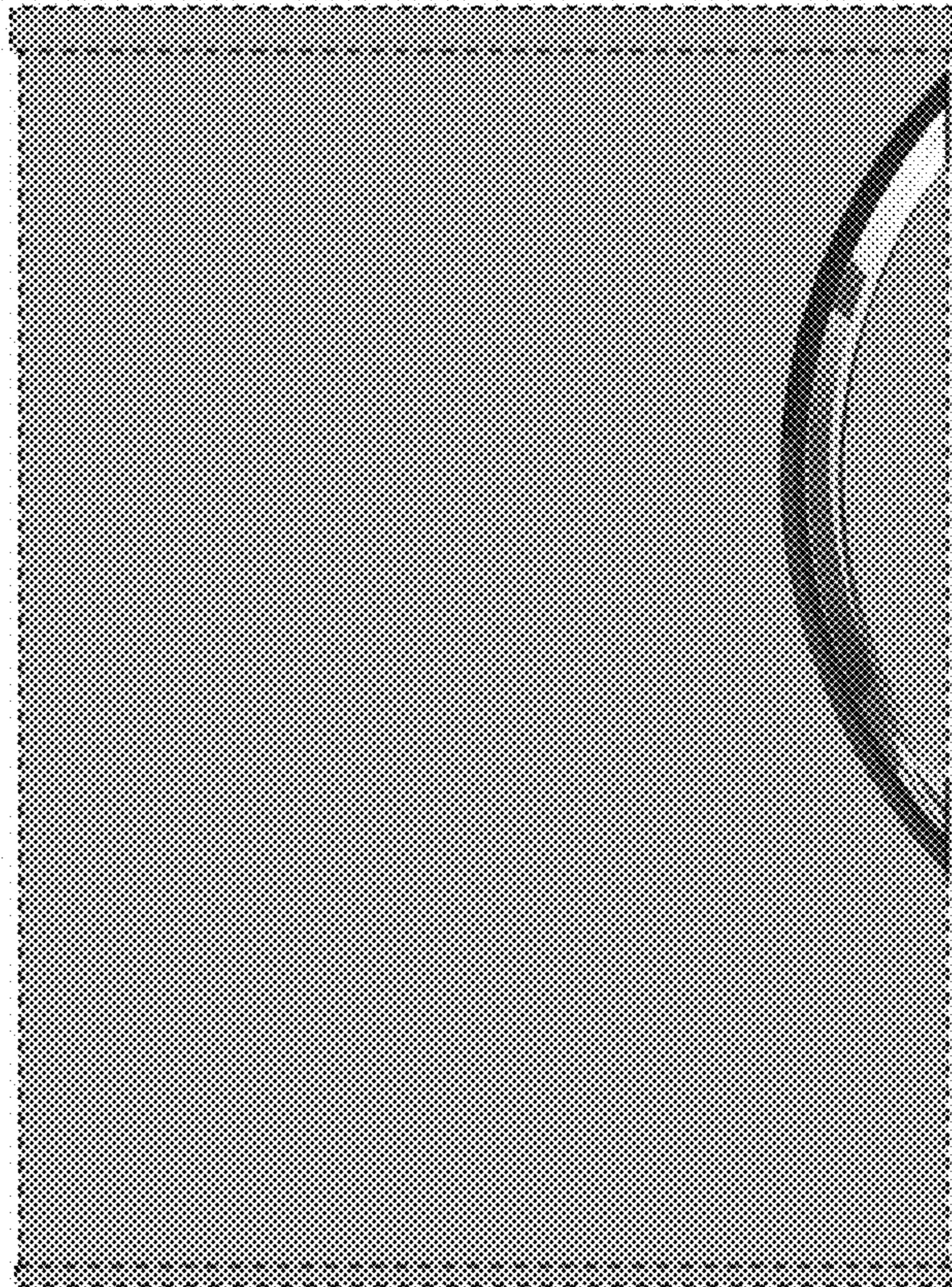

3.7

