



US00D924630S

(12) **United States Design Patent** (10) **Patent No.:** **US D924,630 S**
Hundley et al. (45) **Date of Patent:** **** Jul. 13, 2021**

(54) **COUNTERTOP APPLIANCE**

(71) Applicant: **The Vollrath Company, L.L.C.**,
Sheboygan, WI (US)

(72) Inventors: **Jill Hundley**, Sheboygan, WI (US);
Rebecca Neils, Sheboygan, WI (US)

(73) Assignee: **The Vollrath Company, L.L.C.**,
Sheboygan, WI (US)

(**) Term: **15 Years**

(21) Appl. No.: **29/678,979**

(22) Filed: **Jan. 31, 2019**

(51) **LOC (13) Cl.** **07-99**

(52) **U.S. Cl.**
USPC **D7/403; D7/339**

(58) **Field of Classification Search**
USPC D7/402, 403, 407, 408, 409, 323, 332,
D7/334, 337, 346, 362, 363, 367;
D10/83, 87, 94, 103
CPC G01G 19/40; G01G 21/28; A21B 2/00;
A47J 37/00; A47J 37/06; F24C 7/00;
F24C 15/12
See application file for complete search history.

(56) **References Cited**

U.S. PATENT DOCUMENTS

D613,117 S *	4/2010	Richburg	D7/409
D705,683 S *	5/2014	Lauer	D10/91
D775,540 S *	1/2017	Marmier	D10/91
D818,770 S *	5/2018	Boyd	D7/407
D831,404 S *	10/2018	Glucksman	A47J 36/00
				D7/347
D843,866 S *	3/2019	Mutch	D10/87
D865,452 S *	11/2019	Hertaus	A47J 36/00
				D7/554.3

(Continued)

OTHER PUBLICATIONS

New 2019 Smallwares Countertop Equipment Catalogue, Induction Ranges, pp. 29-33, <https://vollrath.com/Vollrath-Files/Price-Lists/>

New_2019_Smallwares_Countertop_Equipment_Catalog_Web.pdf, accessed Jun. 3, 2019.

Primary Examiner — Susan E Krakower

Assistant Examiner — Andrew Kerr

(74) *Attorney, Agent, or Firm* — Foley & Lardner LLP

(57) **CLAIM**

We claim the ornamental design for a countertop appliance, as shown and described.

DESCRIPTION

FIG. 1 is a front perspective view of a first embodiment of a countertop appliance of our new design; FIG. 2 is a front elevation view thereof; FIG. 3 is a rear elevation view thereof; FIG. 4 is a right side elevation view thereof; FIG. 5 is a left side elevation view thereof; FIG. 6 is a top plan view thereof; FIG. 7 is a bottom plan view thereof; FIG. 8 is a front perspective view of a second embodiment of a countertop appliance of our new design; FIG. 9 is a front elevation view thereof; FIG. 10 is a rear elevation view thereof; FIG. 11 is a right side elevation view thereof; FIG. 12 is a left side elevation view thereof; FIG. 13 is a top plan view thereof; and, FIG. 14 is a bottom plan view thereof.

The even spaced dash-dash broken lines in the figures depict portions of the countertop appliance that form no part of the claimed design. The dash-dot broken lines in FIGS. 1, 4, 5, 8, 11, and 12 define the bounds of the claimed design and form no part thereof.

The countertop appliance is shown with symbolic breaks in length and width. The appearance of any portion of the article between the break lines forms no part of the claimed design.

1 Claim, 10 Drawing Sheets

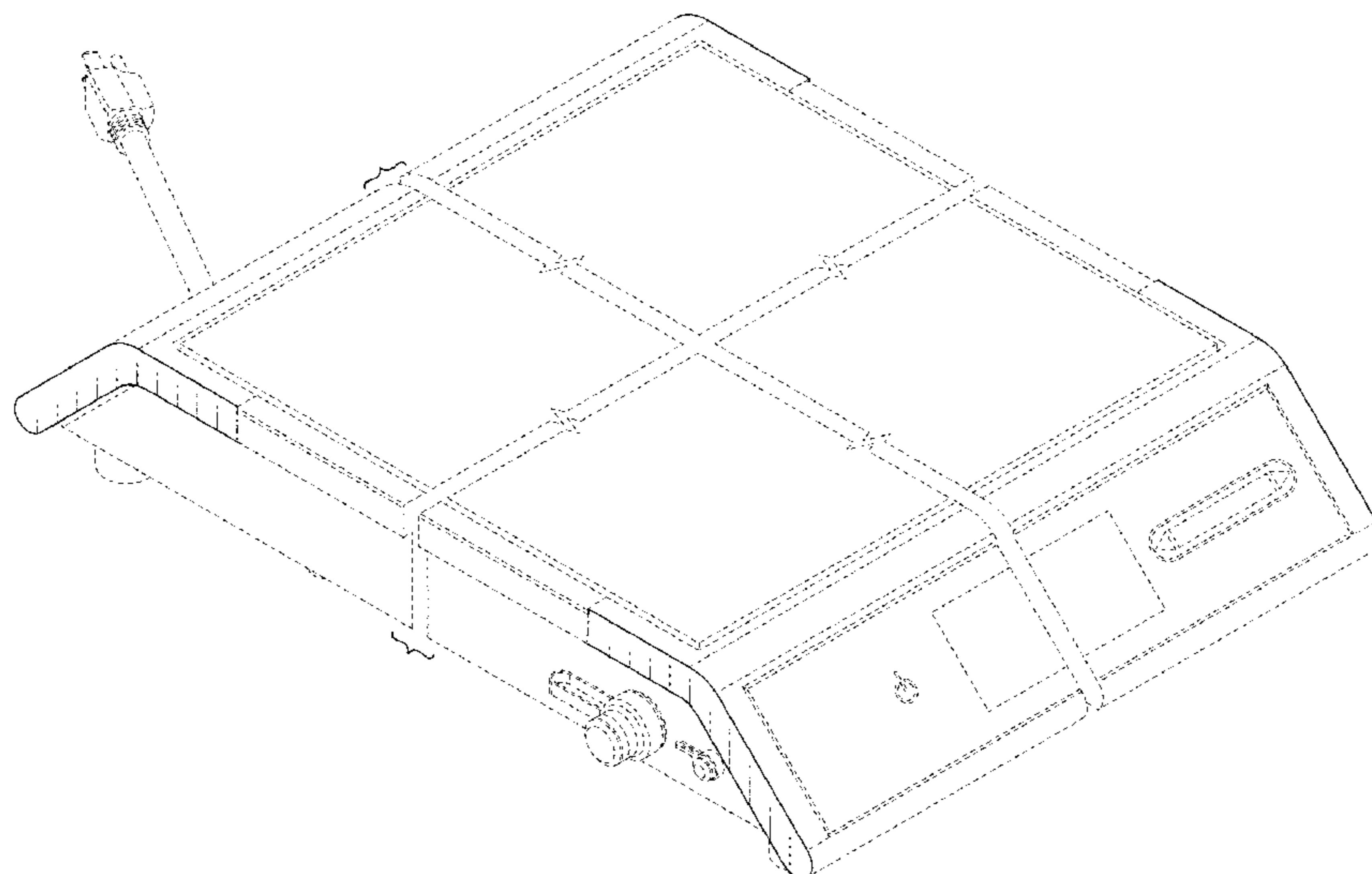

(56)

References Cited

U.S. PATENT DOCUMENTS

D870,579 S * 12/2019 Zong D10/91
2008/0245580 A1 * 10/2008 Aby-Eva G01G 23/3728
177/238

* cited by examiner

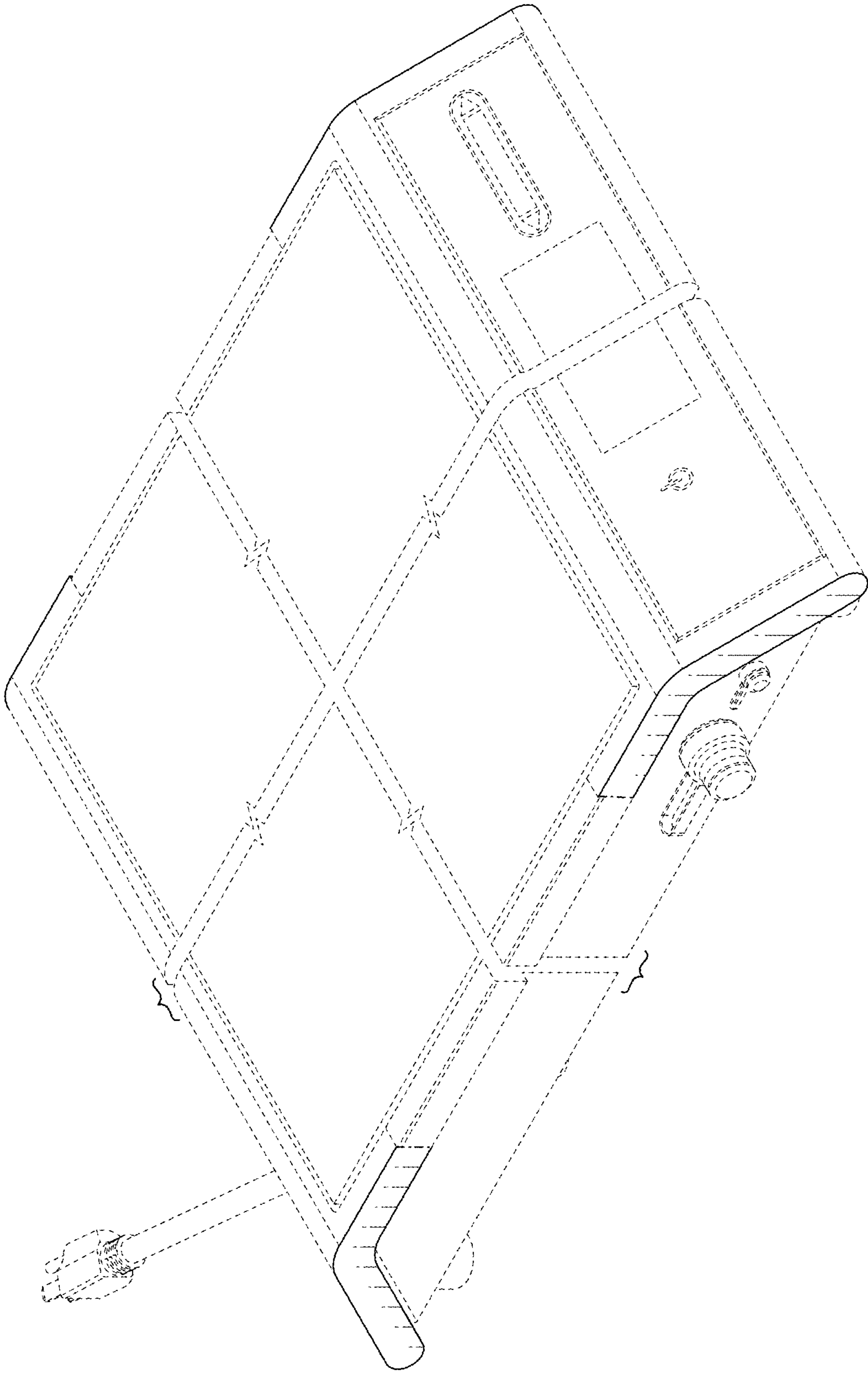

FIG. 1

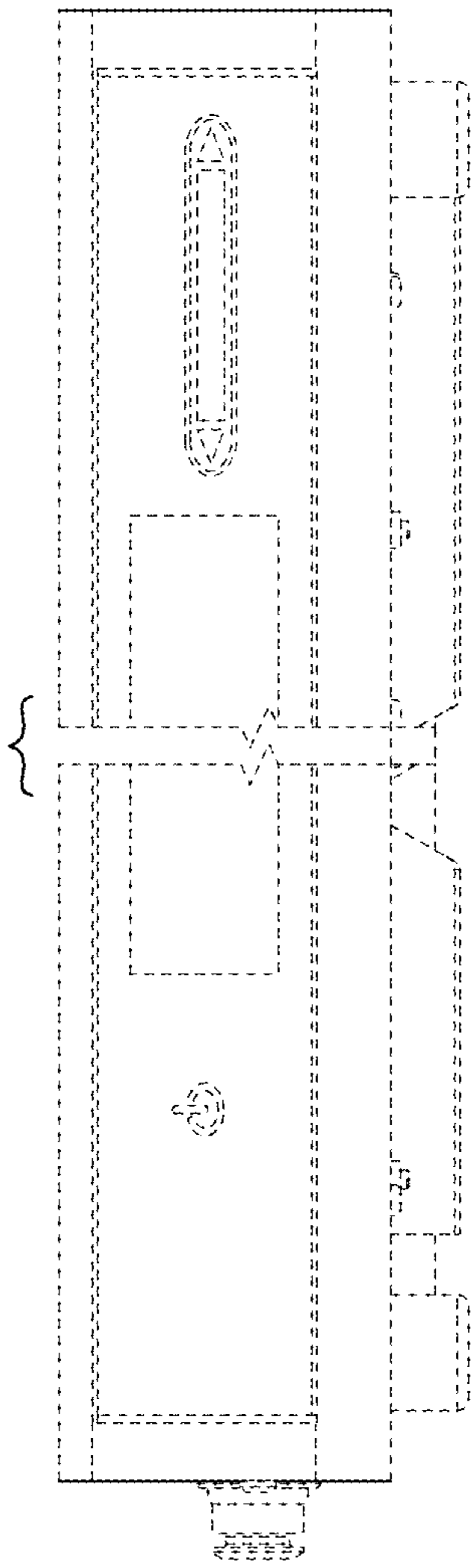

FIG. 2

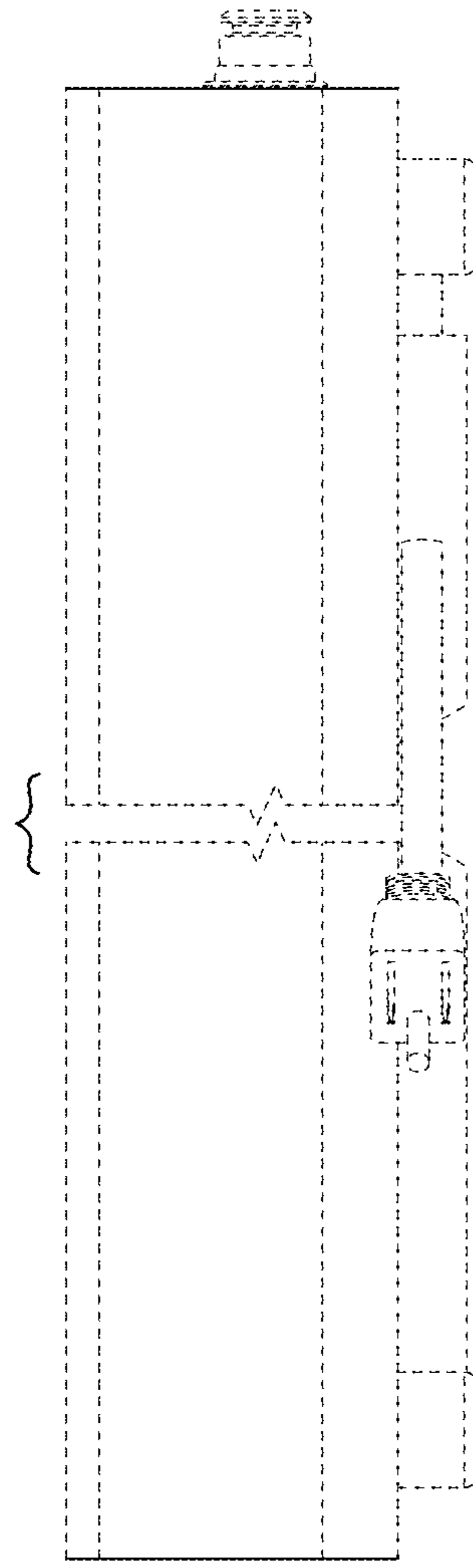

FIG. 3

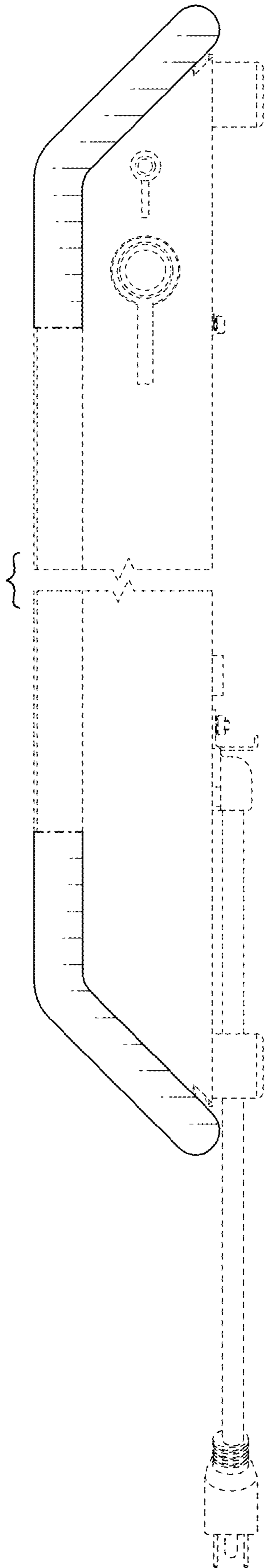

FIG. 4

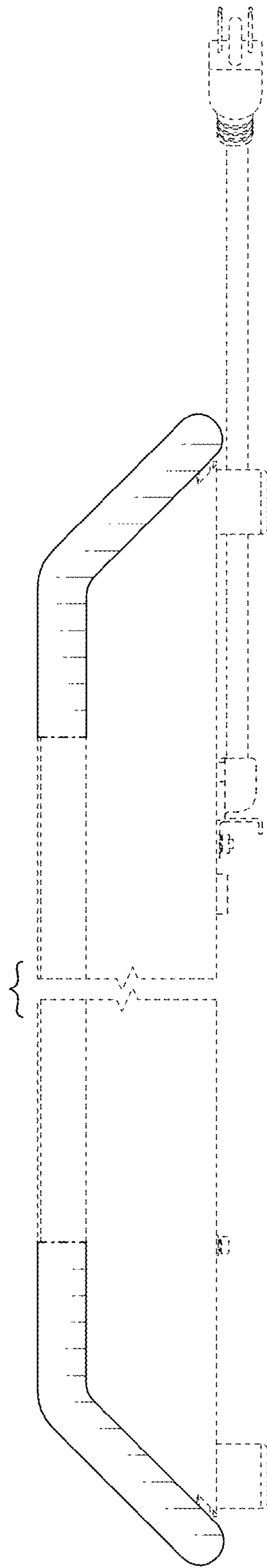

FIG. 5

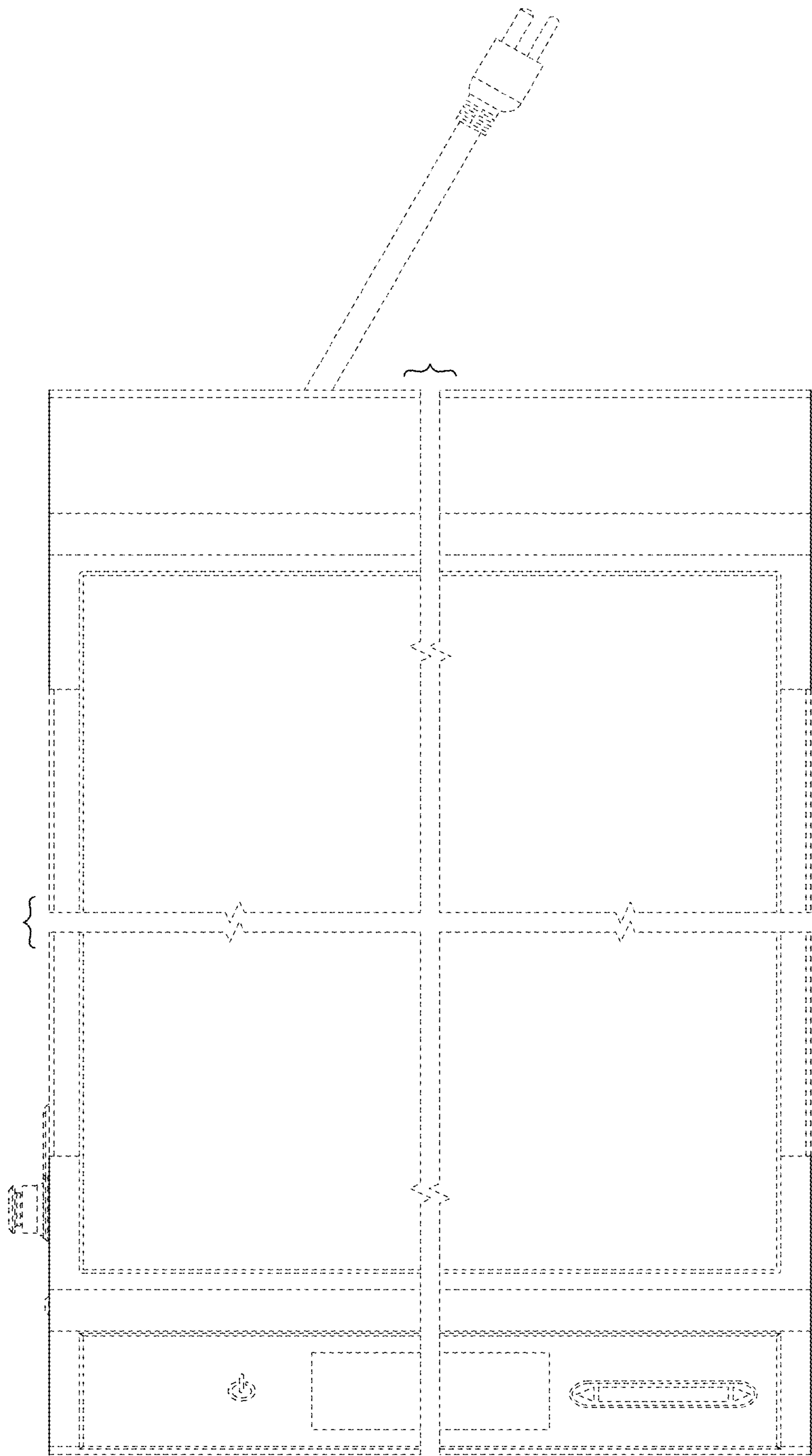

FIG. 6

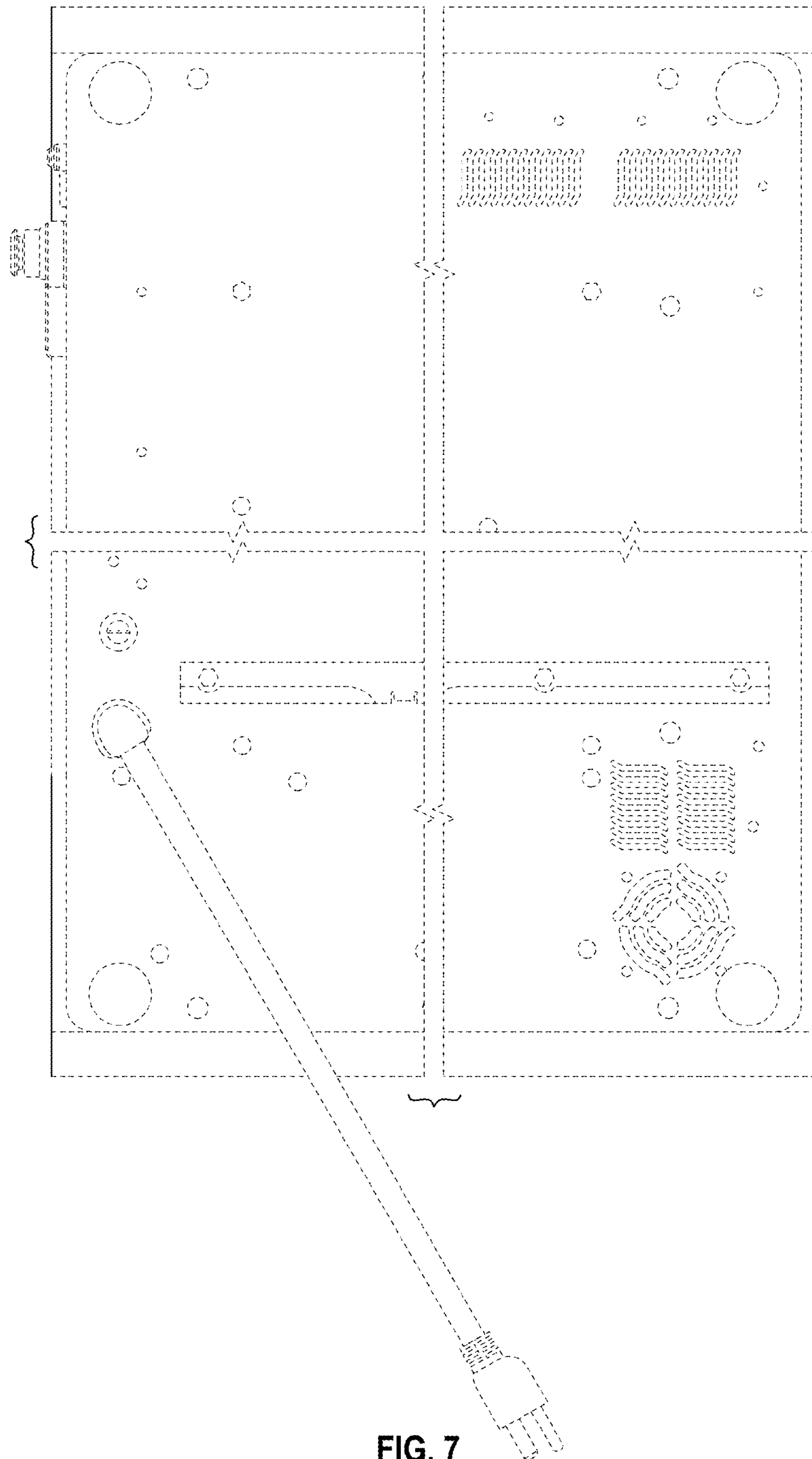

FIG. 7

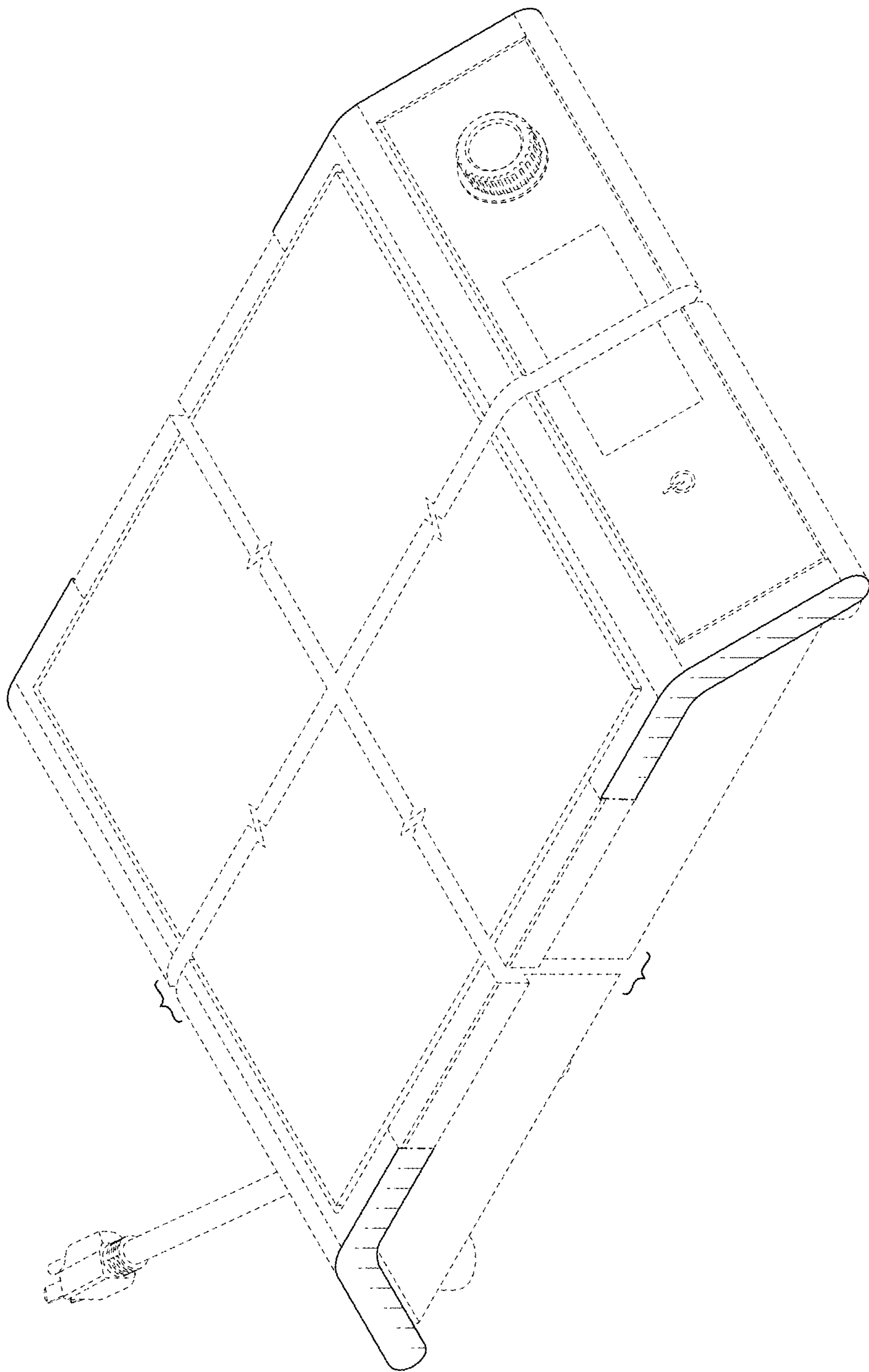

FIG. 8

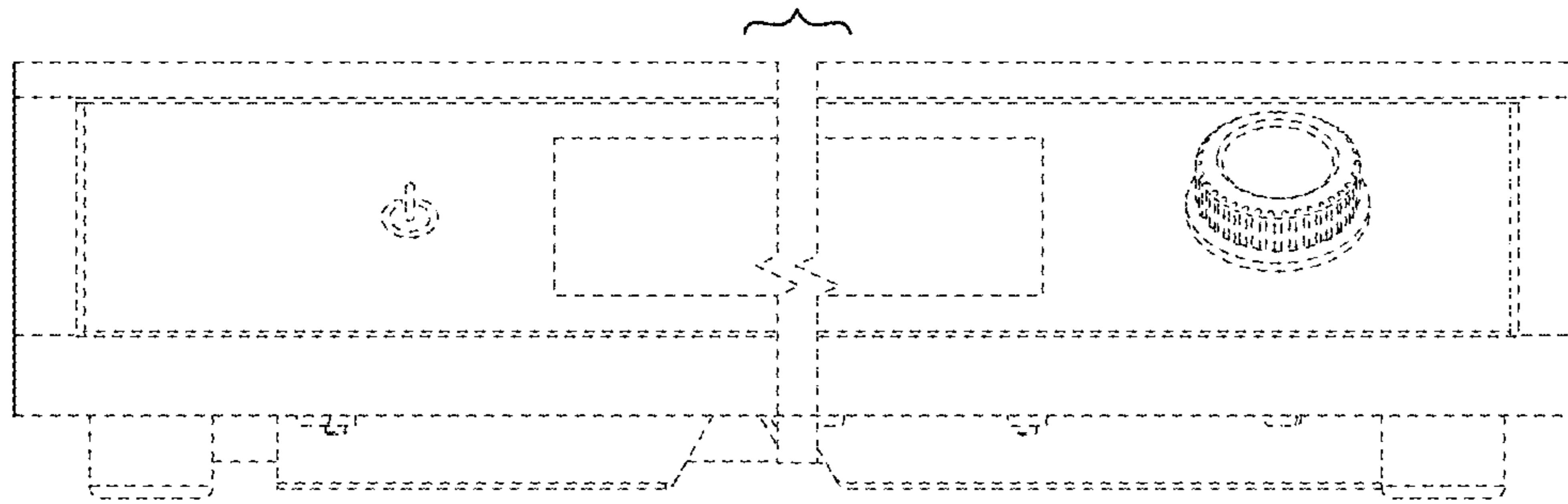

FIG. 9

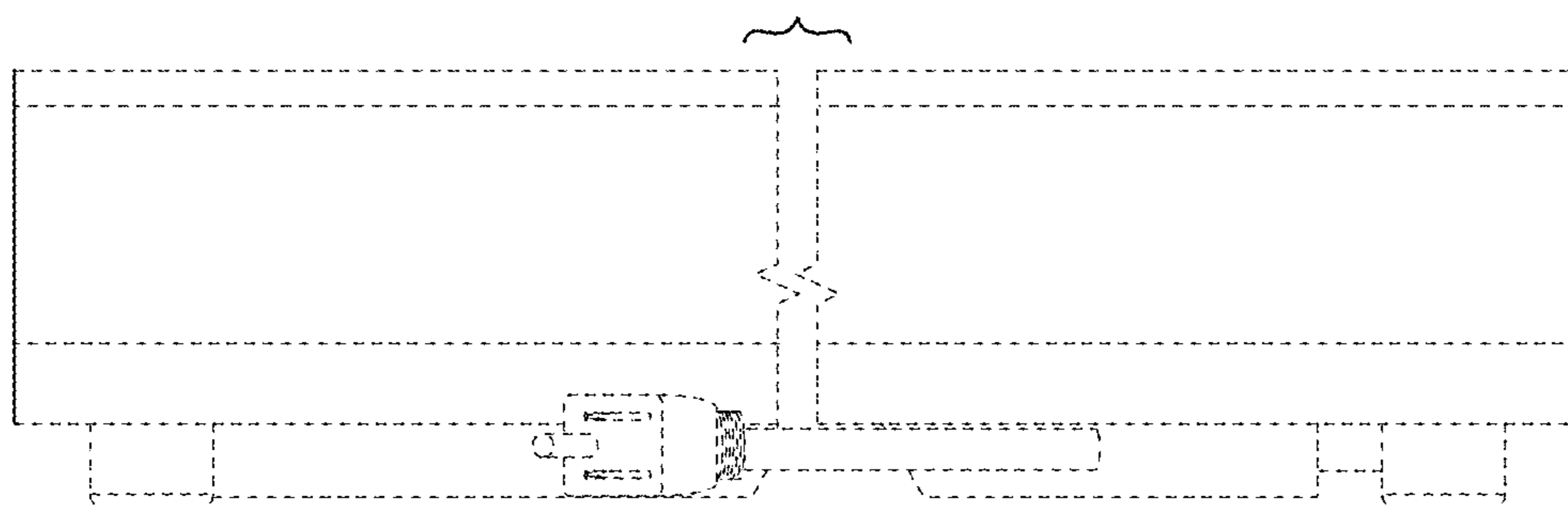

FIG. 10

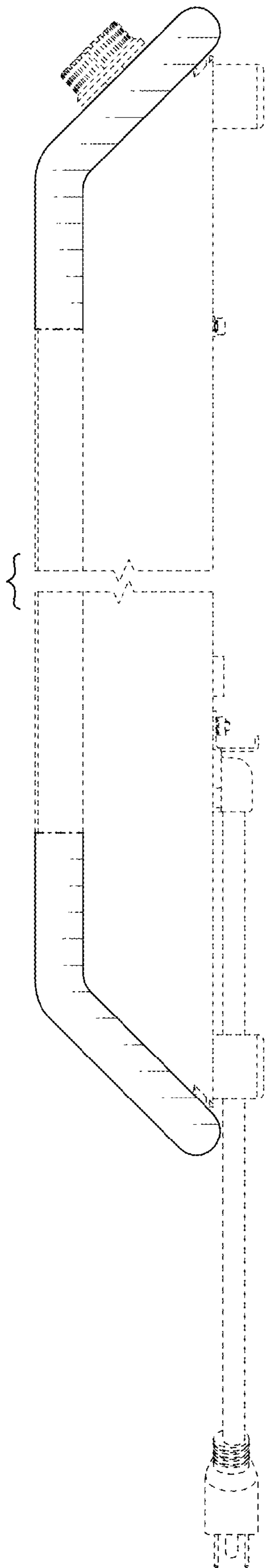

FIG. 11

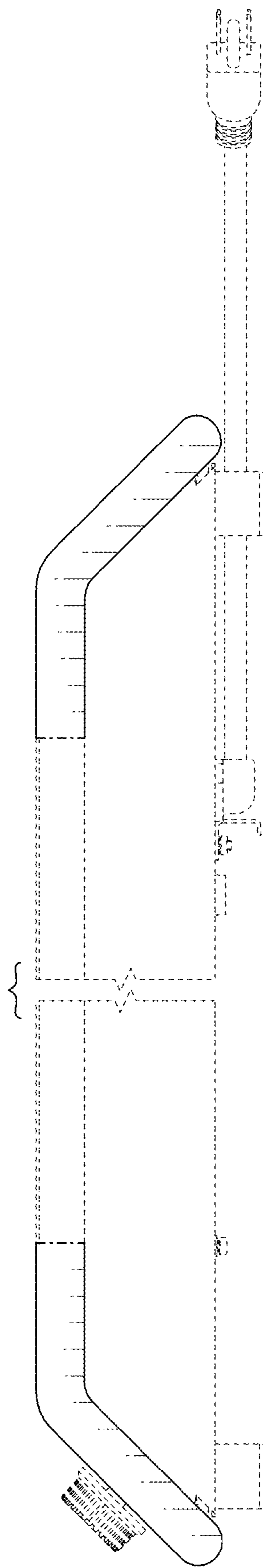

FIG. 12

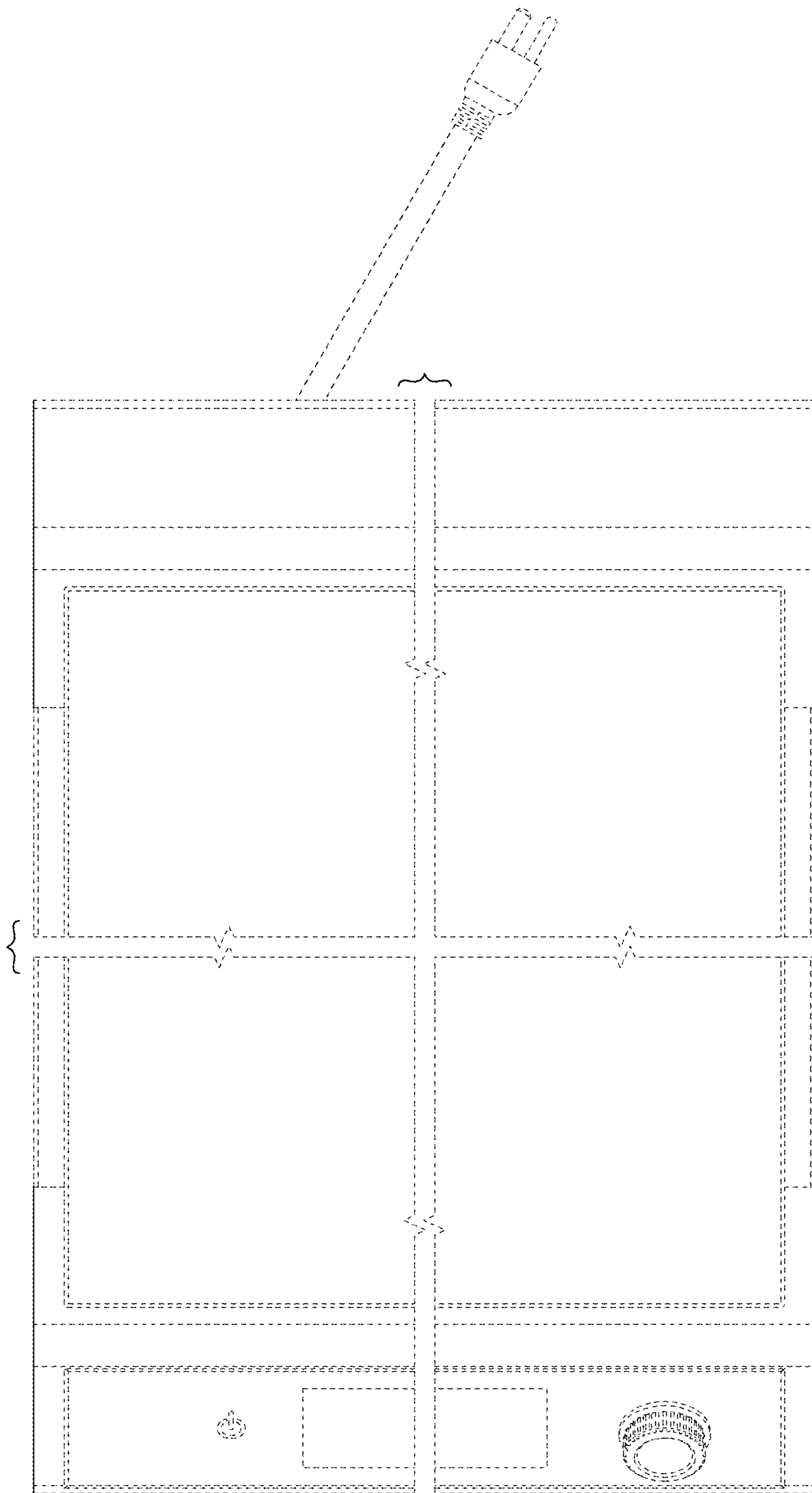

FIG. 13

