



US00D924627S

(12) **United States Design Patent**
Munari

(10) **Patent No.:** **US D924,627 S**

(45) **Date of Patent:** **** Jul. 13, 2021**

- (54) **HANDLE FOR COOKWARE**
- (71) Applicant: **LA TERMOPLASTIC F.B.M. S.r.l.**,
Arsago Seprio (IT)
- (72) Inventor: **Marco Munari**, Cardano al Campo (IT)
- (73) Assignee: **LA TERMOPLASTIC F.B.M. S.R.L.**,
Arsago Seprio (IT)
- (**) Term: **15 Years**
- (21) Appl. No.: **29/699,094**
- (22) Filed: **Jul. 23, 2019**

D617,606 S *	6/2010	Munari	D7/395
D618,051 S *	6/2010	Munari	D7/395
D686,874 S *	7/2013	Rae	D7/395
D693,171 S *	11/2013	Munari	D7/395
D696,552 S *	12/2013	Rae	D7/395
D729,002 S *	5/2015	Barberi	D7/395
D730,686 S *	6/2015	Barberi	D7/395
D741,108 S *	10/2015	Munari	D7/395
D784,074 S *	4/2017	Courteaux	D7/395
D804,243 S *	12/2017	Wang	D7/395
D828,087 S *	9/2018	Munari	D7/395
D832,034 S *	10/2018	Munari	D7/395
D839,046 S *	1/2019	Munari	D7/395
D845,067 S *	4/2019	Barberi	D7/395
D846,942 S *	4/2019	Wang	D7/395
D898,508 S *	10/2020	Barberi	D7/393
2011/0094062 A1 *	4/2011	Pasquini	A47J 45/071 16/430

- (30) **Foreign Application Priority Data**
Jan. 25, 2019 (EM) 006085080
- (51) **LOC (13) Cl.** **07-02**
- (52) **U.S. Cl.**
USPC **D7/395**
- (58) **Field of Classification Search**
USPC D7/354-361, 393-395, 664, 401.2, 402
CPC A47J 45/06; A47J 45/061; A47J 45/062;
A47J 45/071; A47J 45/072; A47J 45/08;
A47J 45/085
See application file for complete search history.

* cited by examiner

Primary Examiner — Cynthia M. Chin
(74) *Attorney, Agent, or Firm* — Cantor Colburn LLP

- (56) **References Cited**
U.S. PATENT DOCUMENTS
D331,171 S * 11/1992 Berthet D7/393
D510,233 S * 10/2005 Giannone D7/395
D525,081 S * 7/2006 Munari D7/395
D526,532 S * 8/2006 Munari D7/395
D527,580 S * 9/2006 Munari D7/395
D562,063 S * 2/2008 Munari D7/395
D578,824 S * 10/2008 Munari D7/395
D589,745 S * 4/2009 Munari D7/395
D590,206 S * 4/2009 Munari D7/395
D615,810 S * 5/2010 Munari D7/395

(57) **CLAIM**
I claim, the ornamental design for a handle for cookware, as shown and described.

DESCRIPTION
FIG. 1 is a perspective view of a handle for cookware, showing my new design;
FIG. 2 is a side view thereof;
FIG. 3 is a front view thereof;
FIG. 4 is a rear view thereof;
FIG. 5 is a top view thereof;
FIG. 6 is a bottom view thereof;
FIG. 7 is another perspective view thereof; and,
FIG. 8 is a side view thereof, opposite from that of FIG. 2.
The broken lines and the areas within them represent portions of the handle for cookware and form no part of the claimed design.

1 Claim, 8 Drawing Sheets

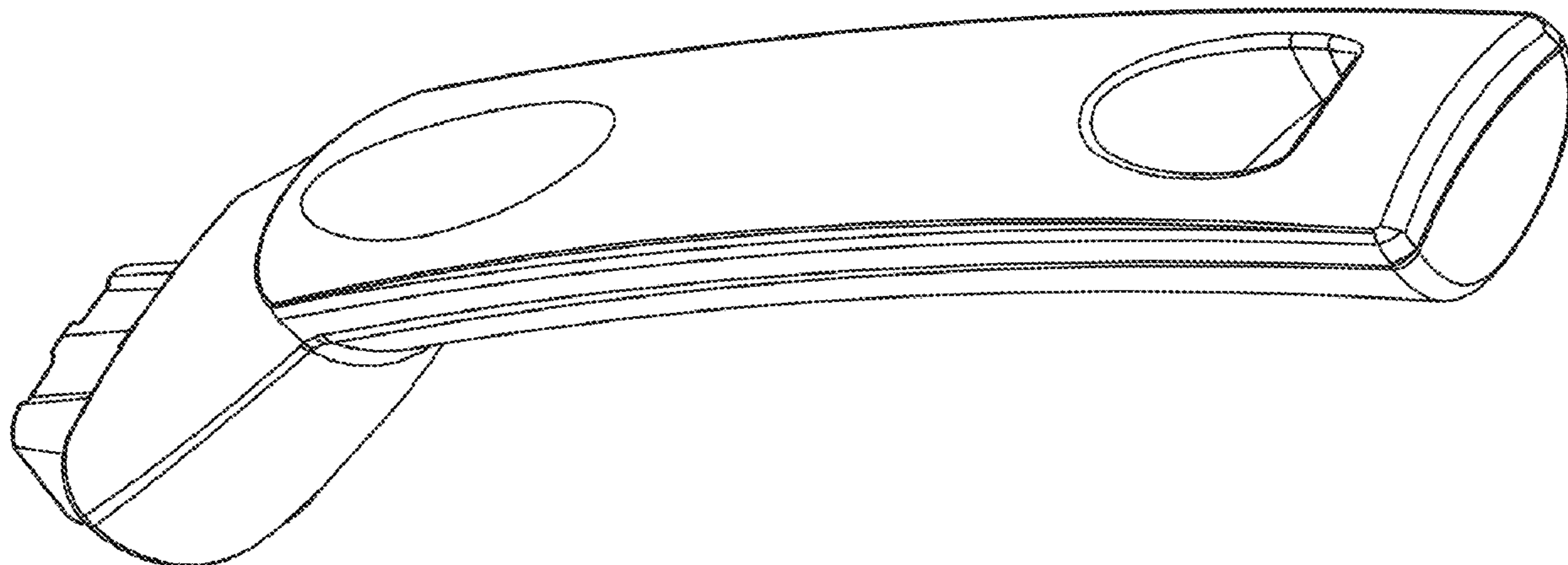

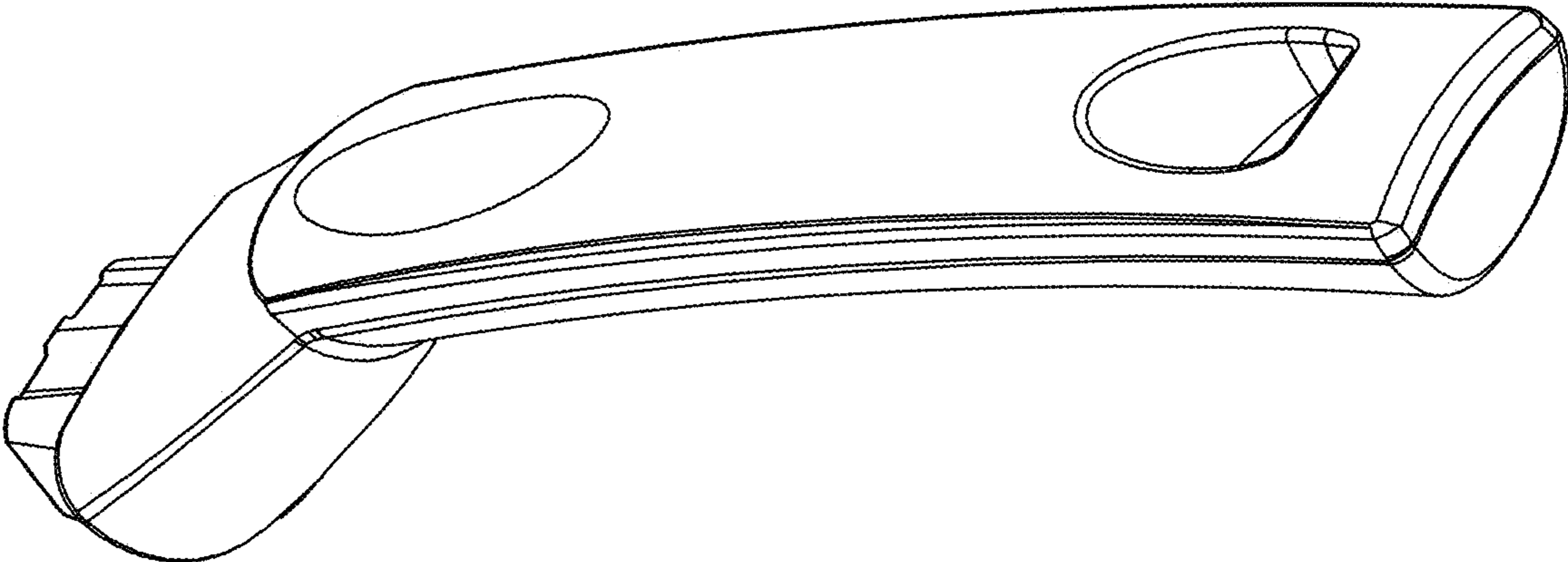

Fig. 1

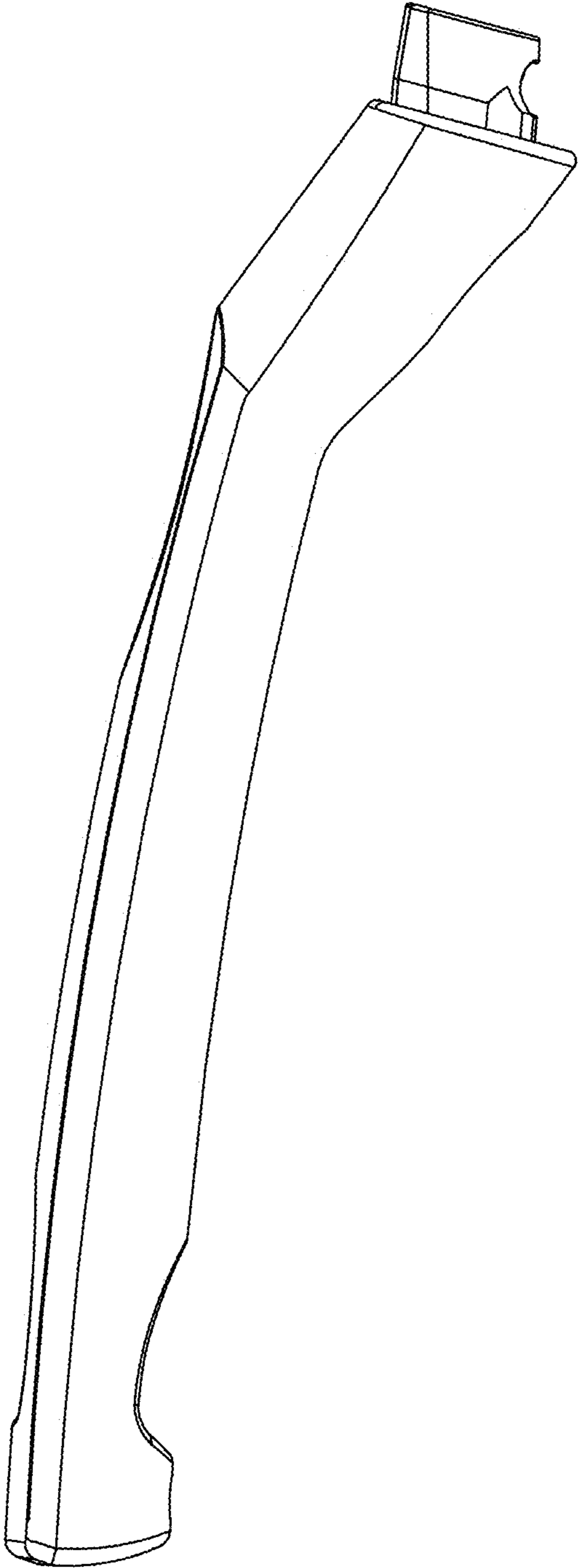

Fig. 2

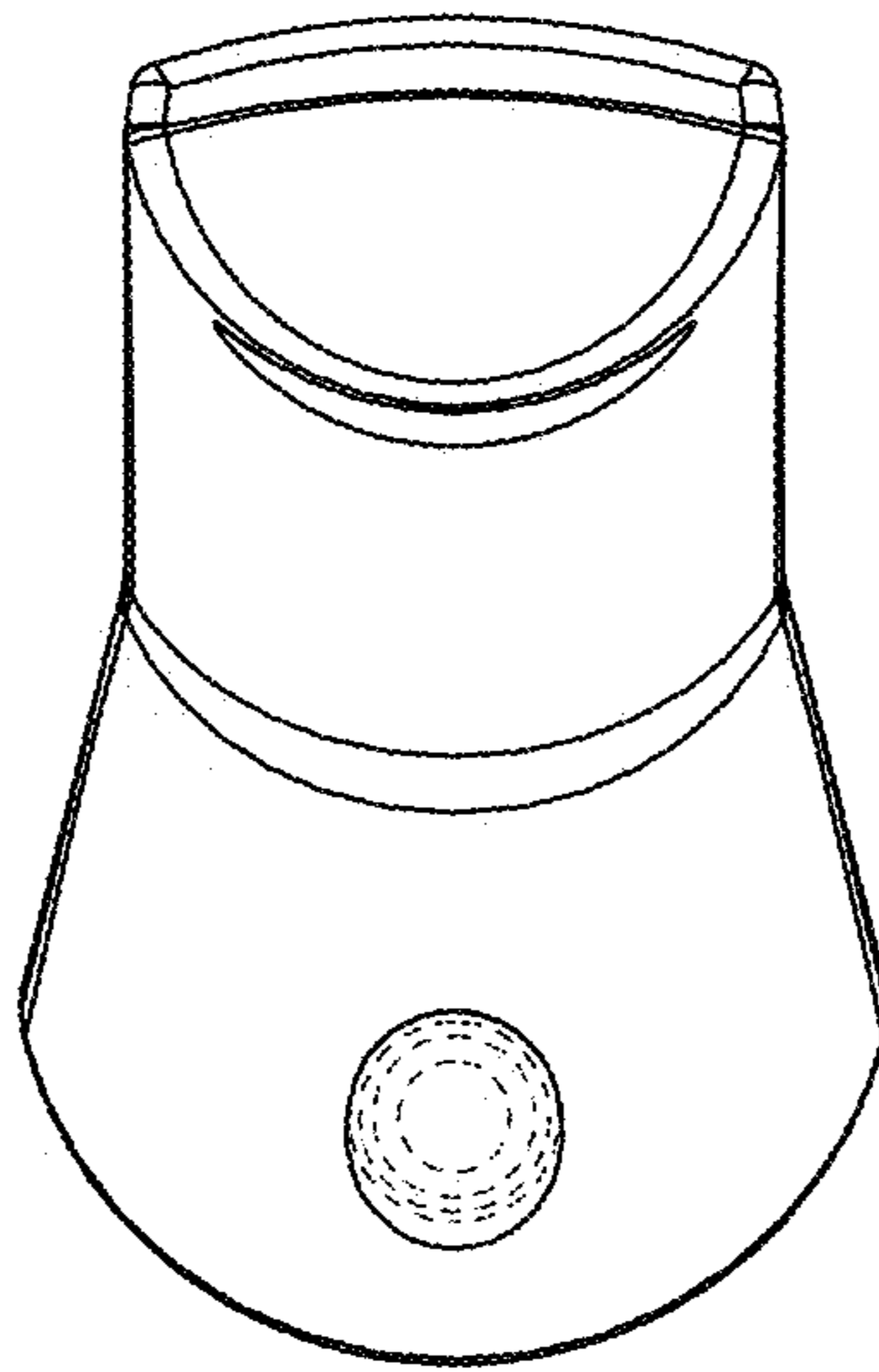

Fig. 3

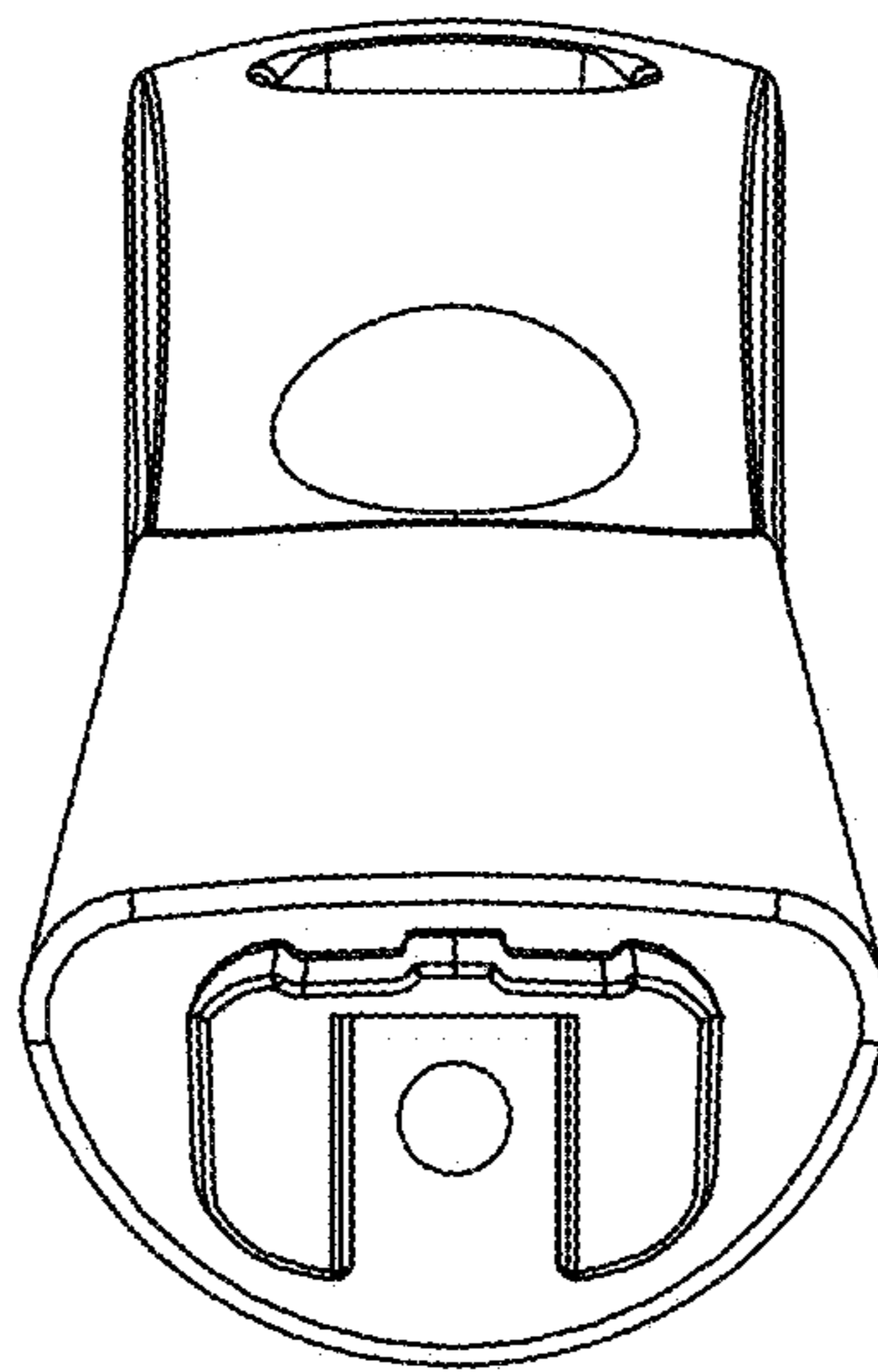

Fig. 4

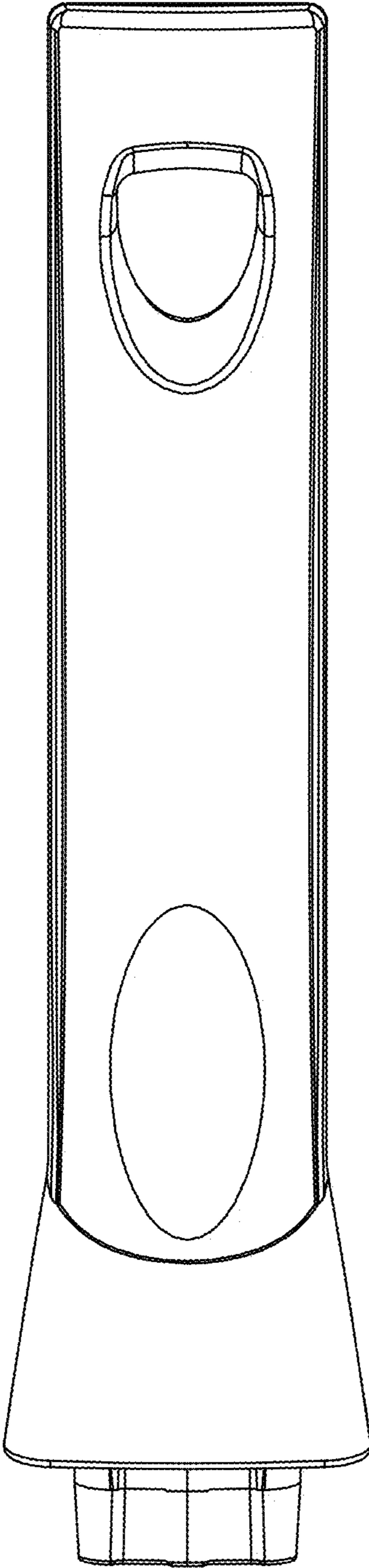

Fig. 5

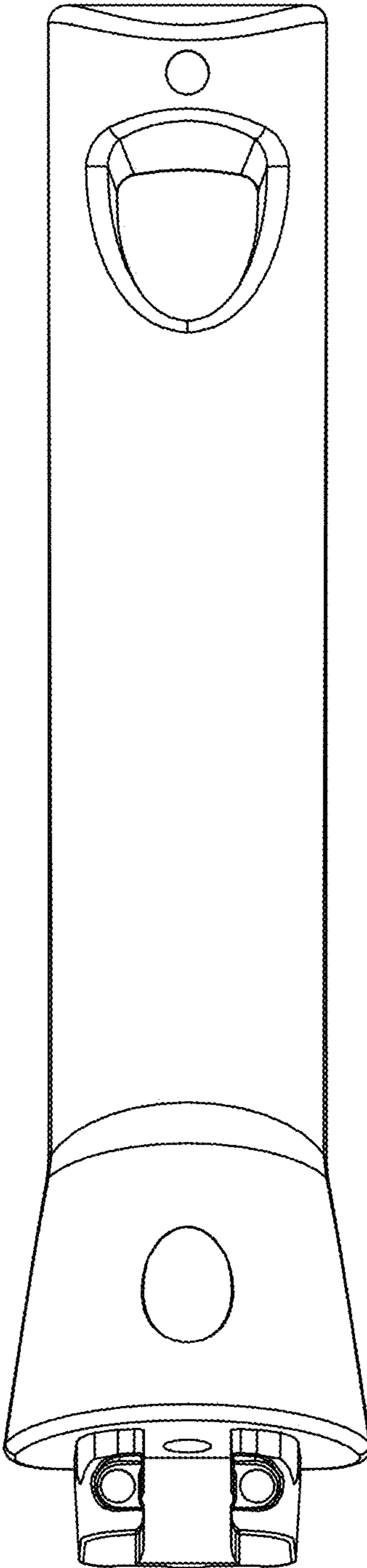

Fig. 6

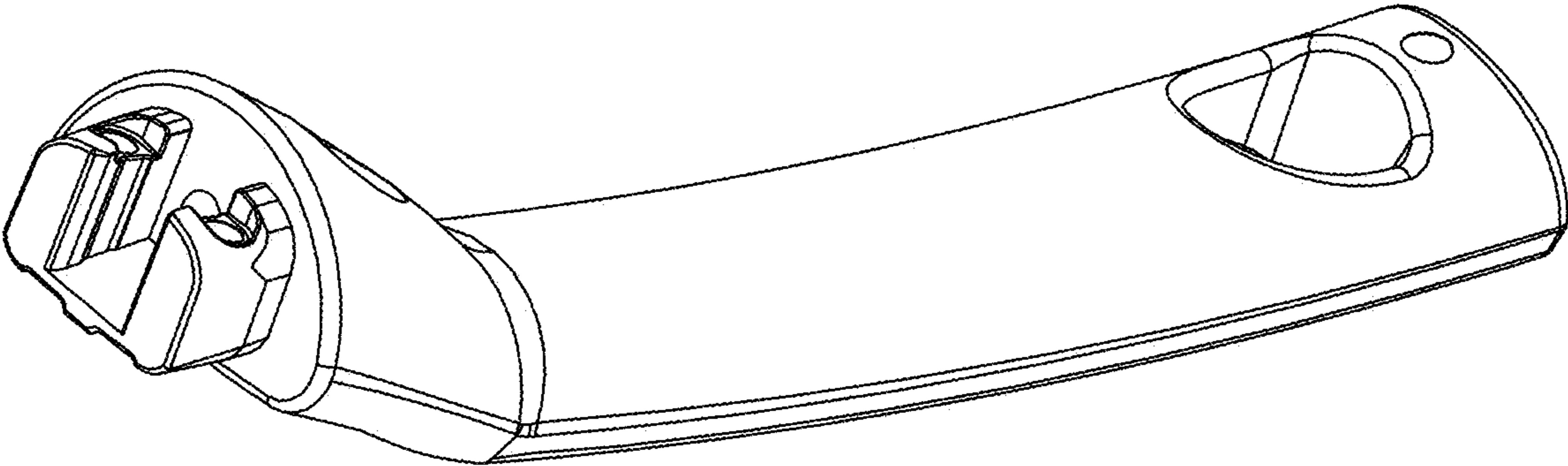

Fig. 7

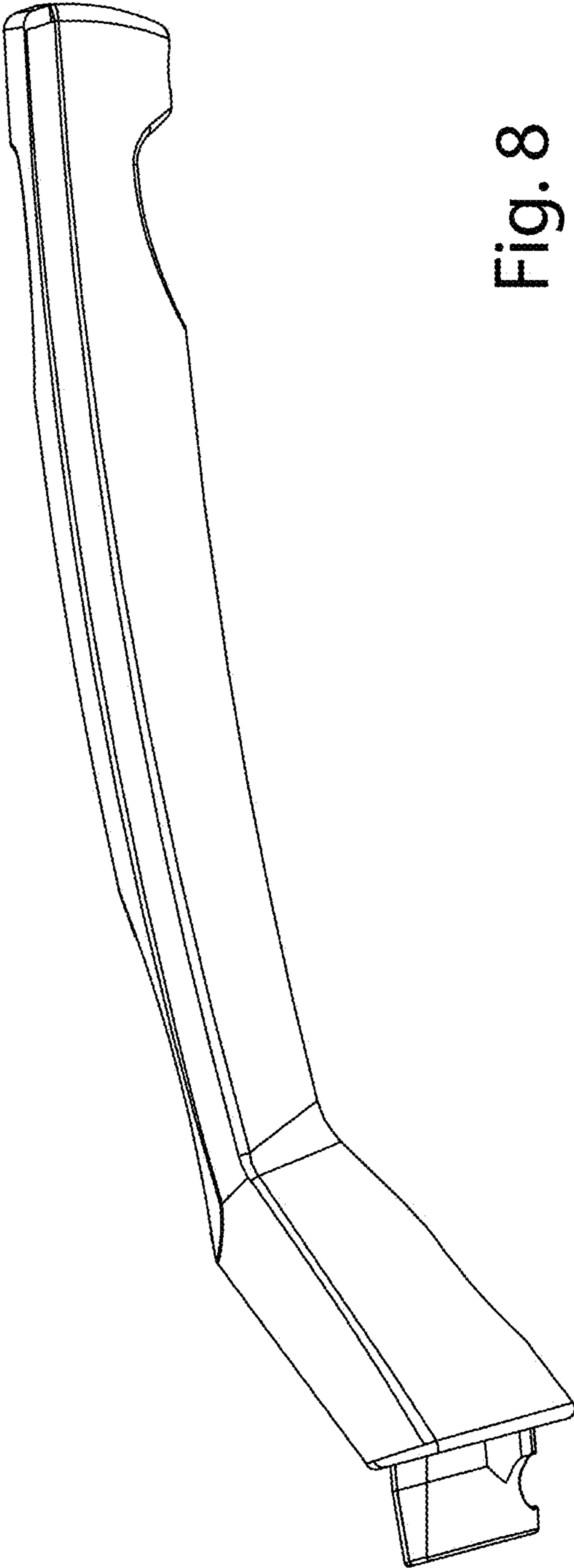

Fig. 8