



US00D924477S

(12) **United States Design Patent** (10) **Patent No.:** **US D924,477 S**
Liu et al. (45) **Date of Patent:** **** Jul. 6, 2021**

(54) **ELECTRONIC ATOMIZING DEVICE ASSEMBLY**
(71) Applicant: **Shenzhen Smoore Technology Limited**, Shenzhen (CN)
(72) Inventors: **Yu Liu**, Shenzhen (CN); **Zhanhui Sun**, Shenzhen (CN); **Yuehan Li**, Shenzhen (CN)
(73) Assignee: **SHENZHEN SMOORE TECHNOLOGY LIMITED**, Shenzhen (CN)
(**) Term: **15 Years**
(21) Appl. No.: **29/730,725**
(22) Filed: **Apr. 8, 2020**
(30) **Foreign Application Priority Data**

Nov. 8, 2019 (CN) 201930615459.6
(51) **LOC (13) Cl.** **27-02**
(52) **U.S. Cl.**
USPC **D27/162**
(58) **Field of Classification Search**
USPC D27/194, 193, 172, 183, 162, 125, 174,
D27/175, 186-188, 192; D7/700;
D13/105-107; D24/110, 110.5

(Continued)
(56) **References Cited**
U.S. PATENT DOCUMENTS
D819,882 S * 6/2018 Qiu D27/101
D863,673 S * 10/2019 Lai D27/162
(Continued)

OTHER PUBLICATIONS
US D910,903 S, 02/2021, Bailey (withdrawn)*
Primary Examiner — Marissa J Cash
Assistant Examiner — Rebecca Tsehaye

(57) **CLAIM**
The ornamental design for an electronic atomizing device assembly, as shown and described.

DESCRIPTION

FIG. 1 is a perspective view of an electronic atomizing device assembly according to a first embodiment of our design;

FIG. 2 is another perspective view thereof;
FIG. 3 is a front elevational view thereof;
FIG. 4 is a rear elevational view thereof;
FIG. 5 is a left side elevational view thereof;
FIG. 6 is a right side elevational view thereof;
FIG. 7 is a top plan view thereof;
FIG. 8 is a bottom plan view thereof;
FIG. 9 is a perspective view of an electronic atomizing device assembly showing a first component removed from the assembly shown in FIGS. 1-8, for clarity of disclosure;
FIG. 10 is another perspective view thereof;
FIG. 11 is a front elevational view thereof;
FIG. 12 is a rear elevational view thereof;
FIG. 13 is a left side elevational view thereof;
FIG. 14 is a right side elevational view thereof;
FIG. 15 is a top plan view thereof;
FIG. 16 is a bottom plan view thereof;
FIG. 17 is a perspective view of an electronic atomizing device assembly showing a second component removed from the assembly shown in FIGS. 1-8, for clarity of disclosure;
FIG. 18 is another perspective view thereof;
FIG. 19 is a front elevational view thereof;
FIG. 20 is a rear elevational view thereof;
FIG. 21 is a left side elevational view thereof;
FIG. 22 is a right side elevational view thereof;
FIG. 23 is a top plan view thereof;
FIG. 24 is a bottom plan view thereof;
FIG. 25 is a perspective view of an electronic atomizing device assembly according to a second embodiment of our design;
FIG. 26 is another perspective view thereof;
FIG. 27 is a front elevational view thereof;
FIG. 28 is a rear elevational view thereof;
FIG. 29 is a left side elevational view thereof;
FIG. 30 is a right side elevational view thereof;
FIG. 31 is a top plan view thereof;
FIG. 32 is a bottom plan view thereof;
FIG. 33 is a perspective view of an electronic atomizing device assembly showing a first component removed from the assembly shown in FIGS. 25-32, for clarity of disclosure;
FIG. 34 is another perspective view thereof;
FIG. 35 is a front elevational view thereof;
FIG. 36 is a rear elevational view thereof;
FIG. 37 is a left side elevational view thereof;

(Continued)

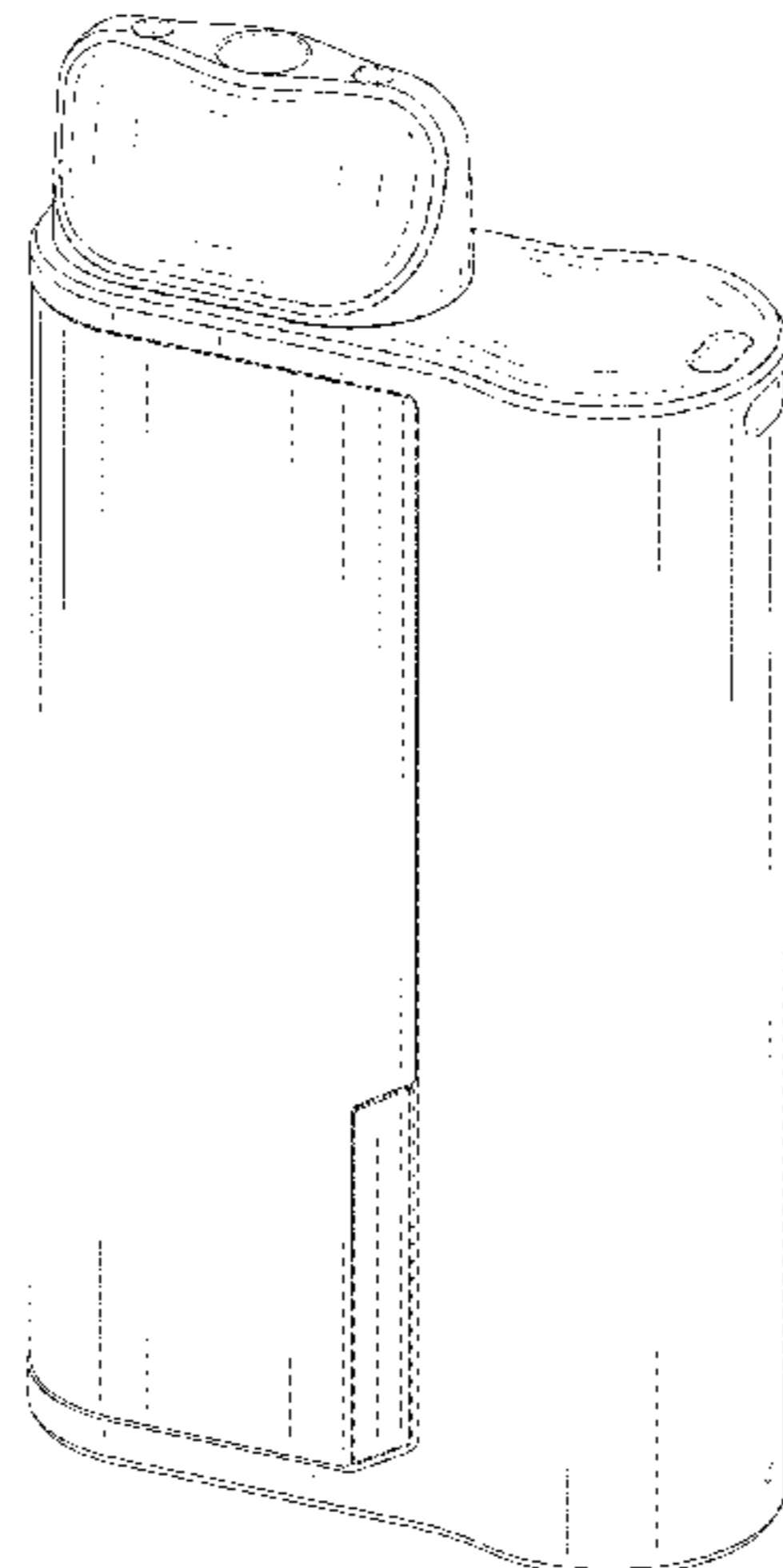

FIG. 38 is a right side elevational view thereof;
FIG. 39 is a top plan view thereof; and,
FIG. 40 is a bottom plan view thereof.
The broken lines in the drawings depict portions of the
electronic atomizing device assembly that form no part of
the claimed design.
The oblique shade lines in the figures show transparency.

1 Claim, 40 Drawing Sheets

(58) **Field of Classification Search**

CPC B67C 11/00; B67C 2011/022; B67C
2011/30; B01D 23/28; A24F 47/002;
A24F 47/006; A24F 47/008; A61M
15/00; A61M 15/06

See application file for complete search history.

(56) **References Cited**

U.S. PATENT DOCUMENTS

D871,666 S *	12/2019	Qiu	D27/163
D875,303 S *	2/2020	Pan	D27/162
D875,306 S *	2/2020	Pan	D27/167
D889,736 S *	7/2020	Han	D27/162
D895,199 S *	9/2020	Li	D27/162
D900,385 S *	10/2020	Wang	D27/162
D902,473 S *	11/2020	Li	D27/101
D902,480 S *	11/2020	Chen	D27/194
D903,936 S *	12/2020	He	D27/162
D904,680 S *	12/2020	Pan	D27/162
D908,279 S *	1/2021	Li	D27/162
D910,907 S *	2/2021	Liu	D27/162

* cited by examiner

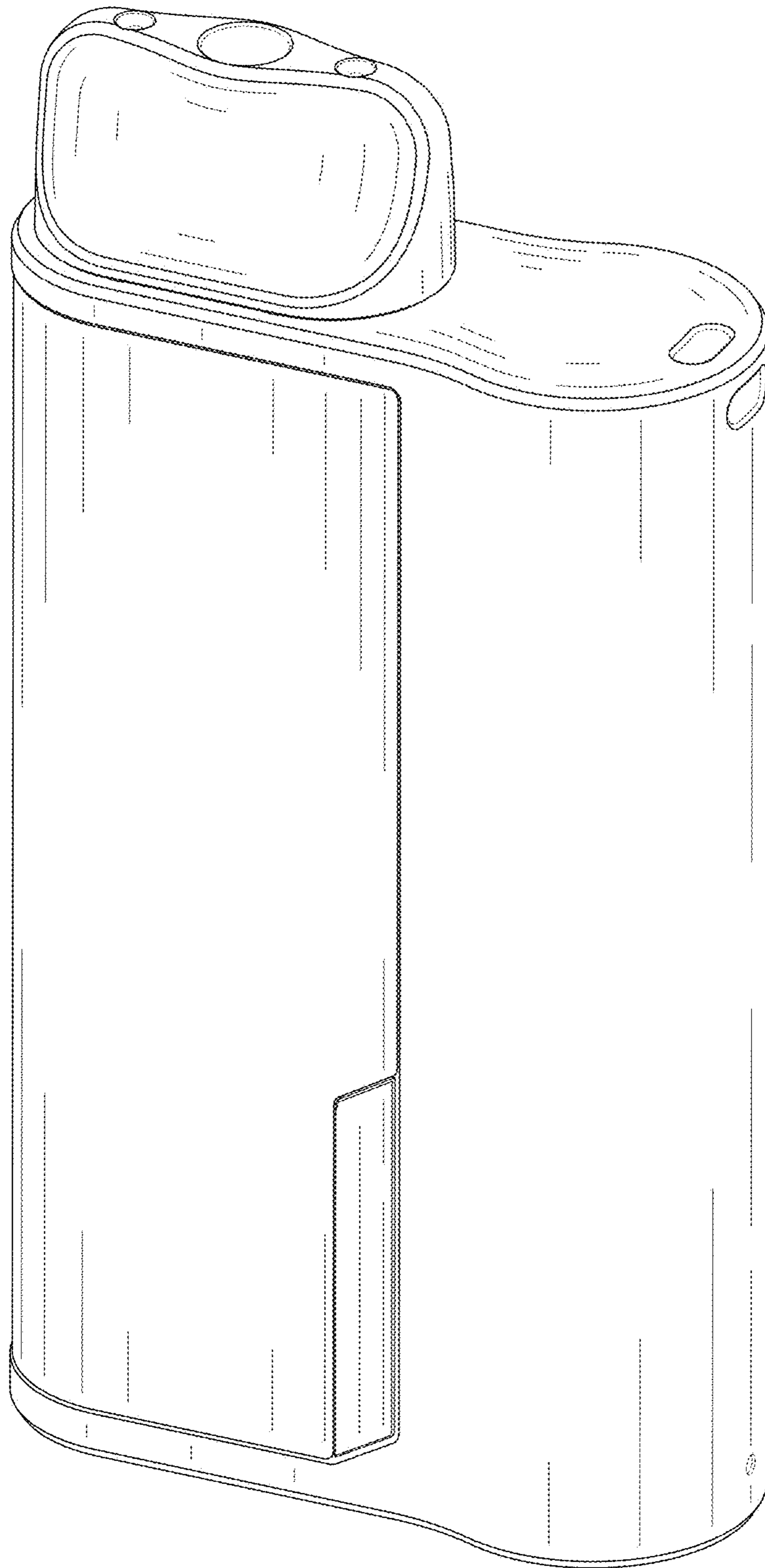

FIG. 1

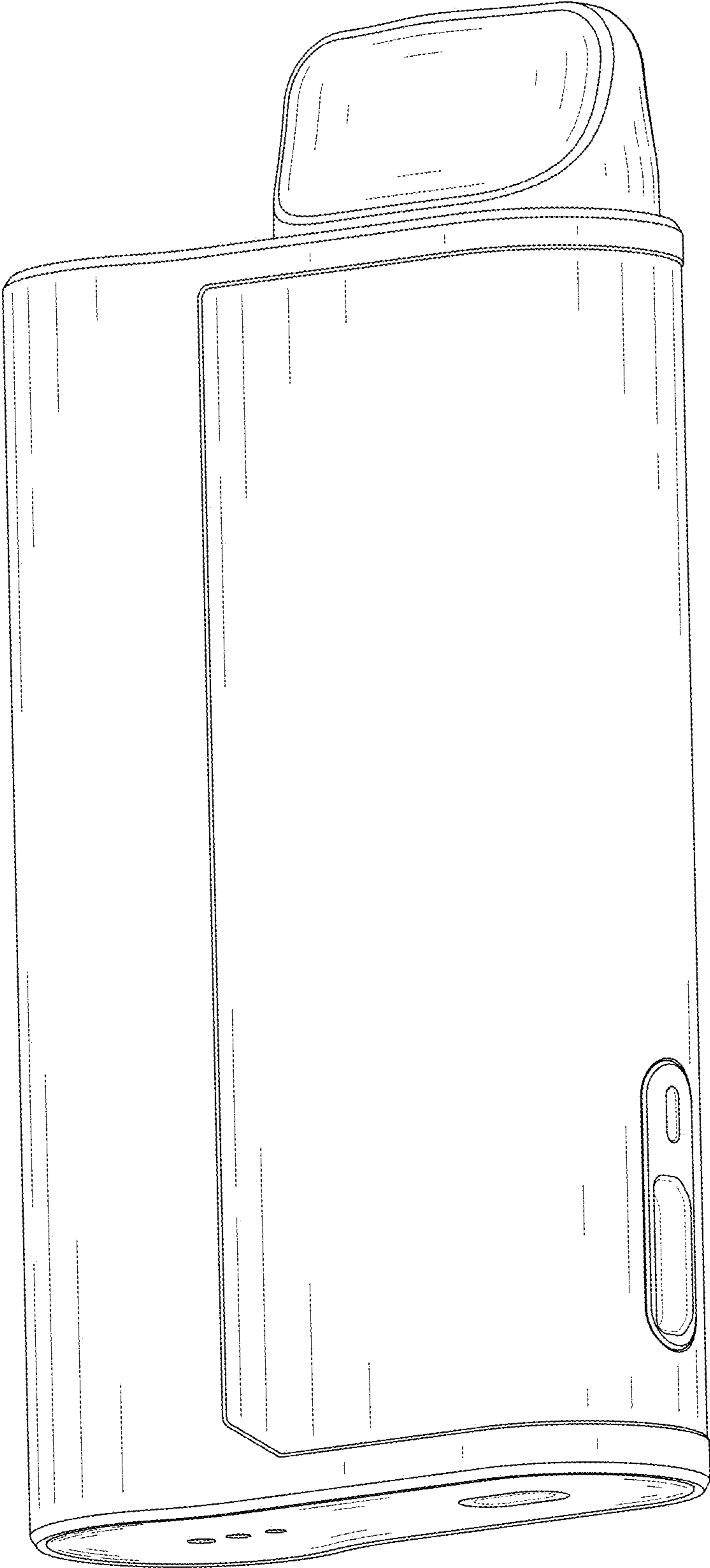

FIG. 2

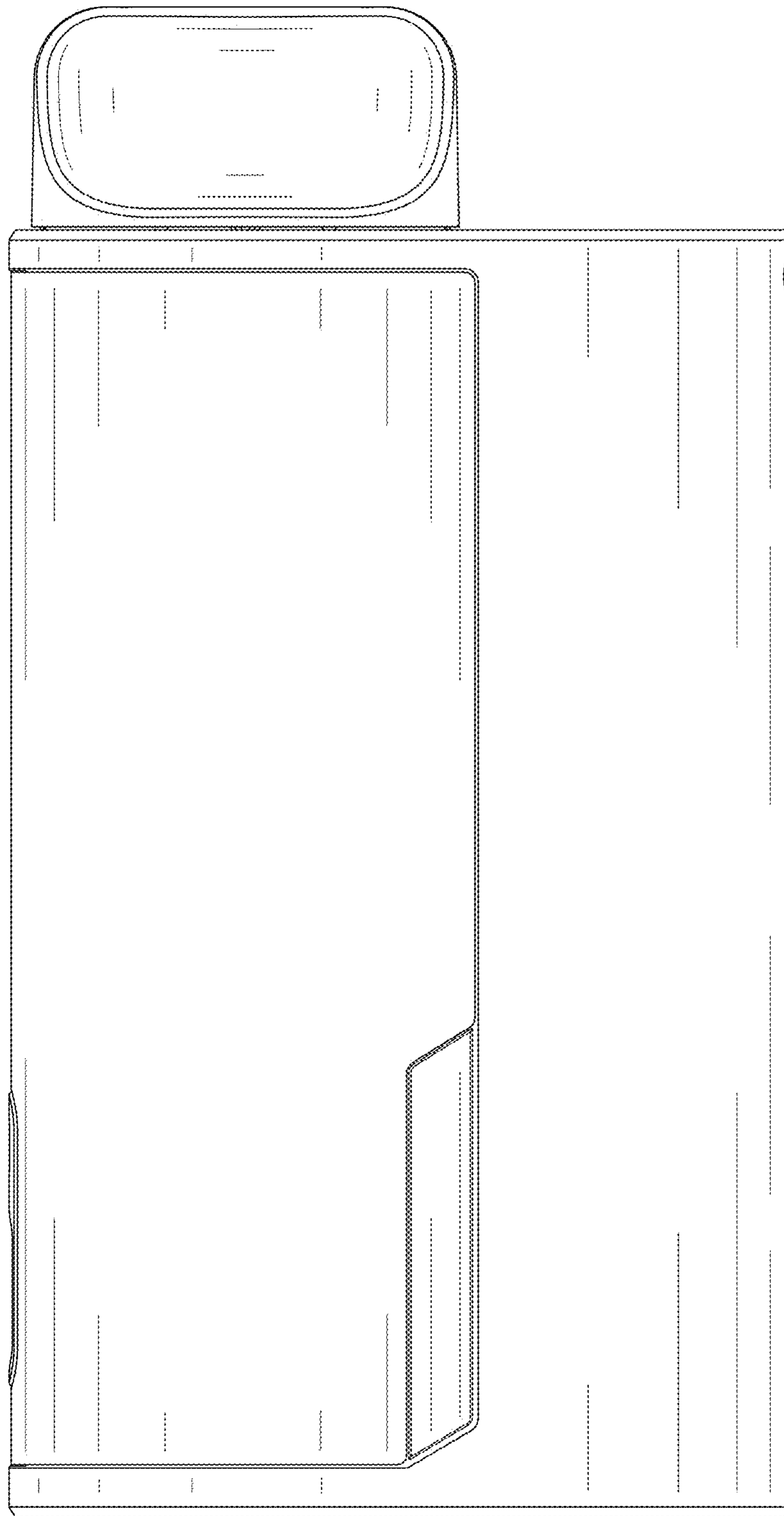

FIG. 3

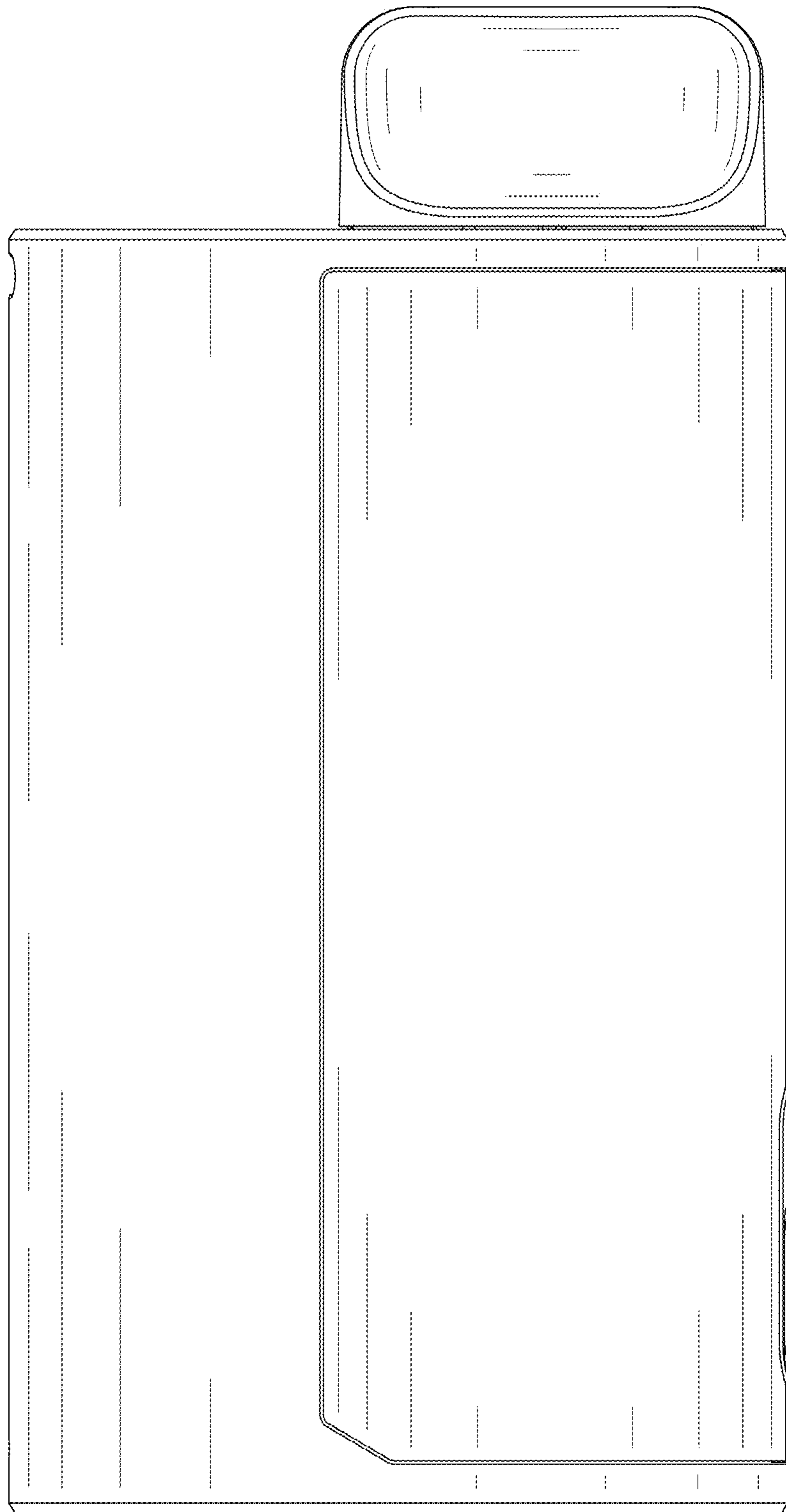

FIG. 4

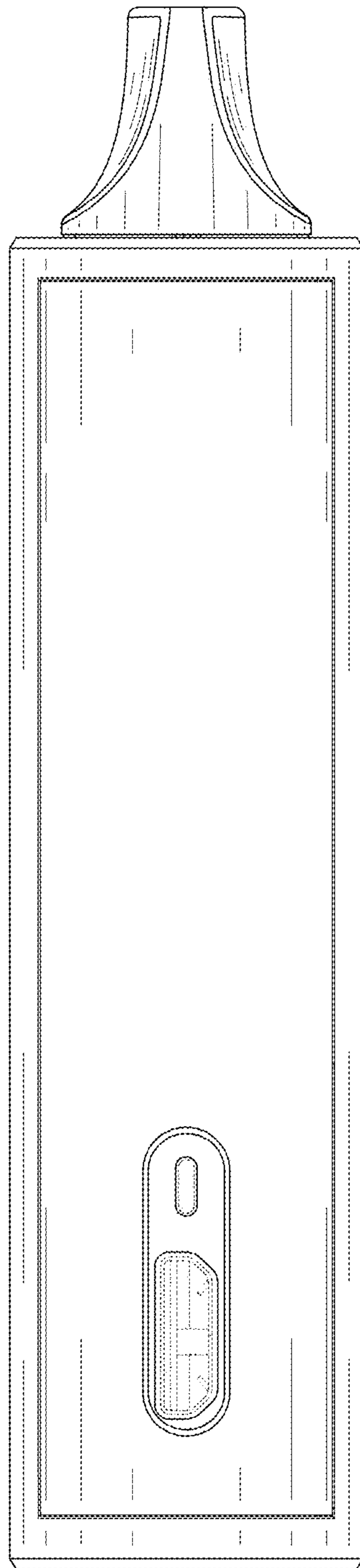

FIG. 5

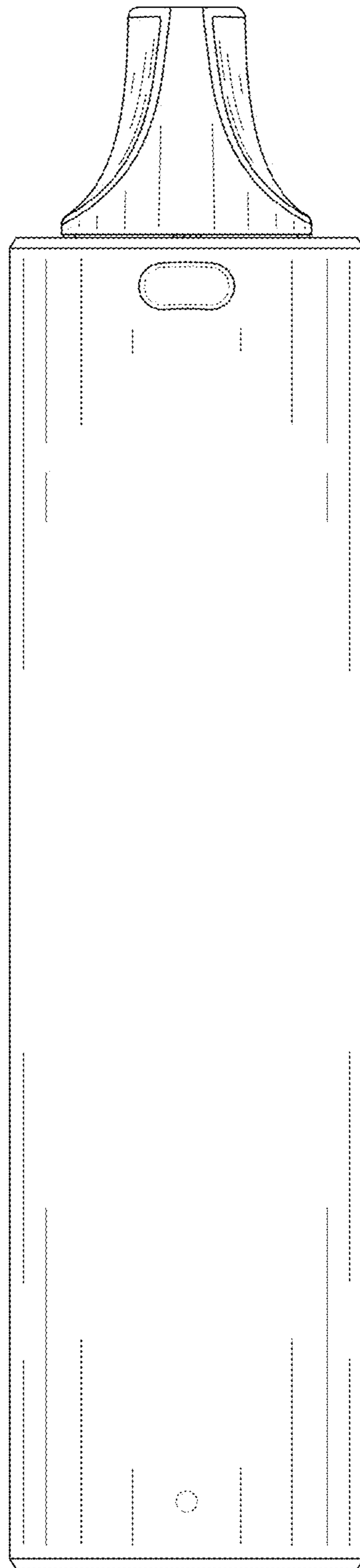

FIG. 6

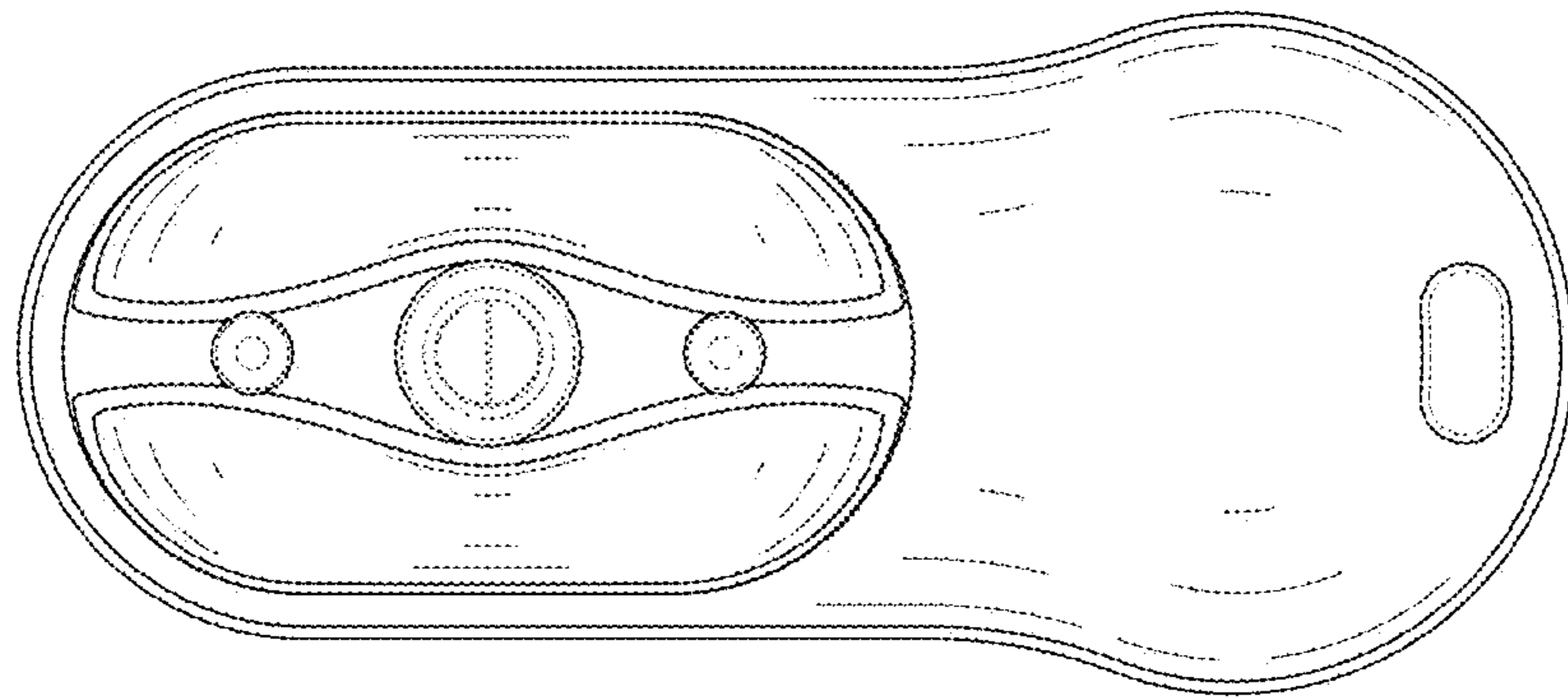

FIG. 7

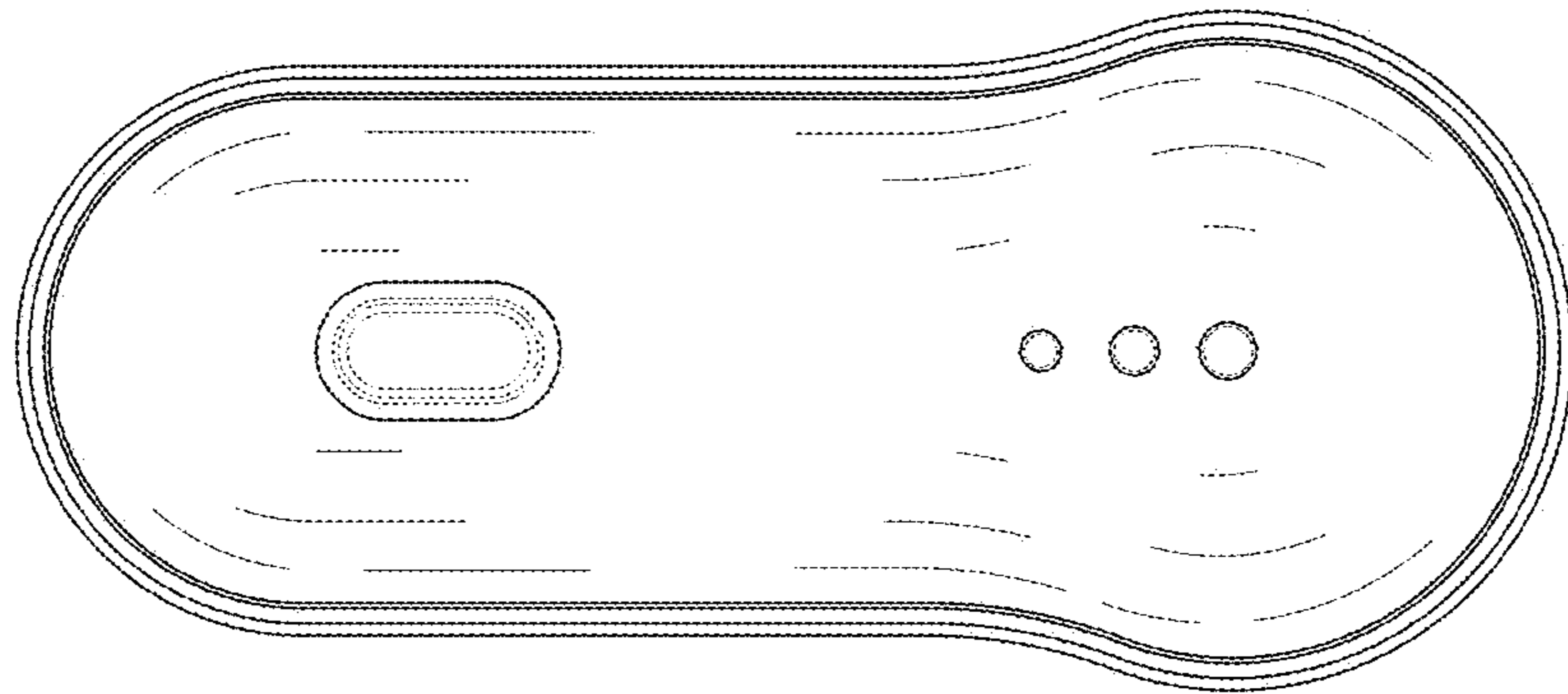

FIG. 8

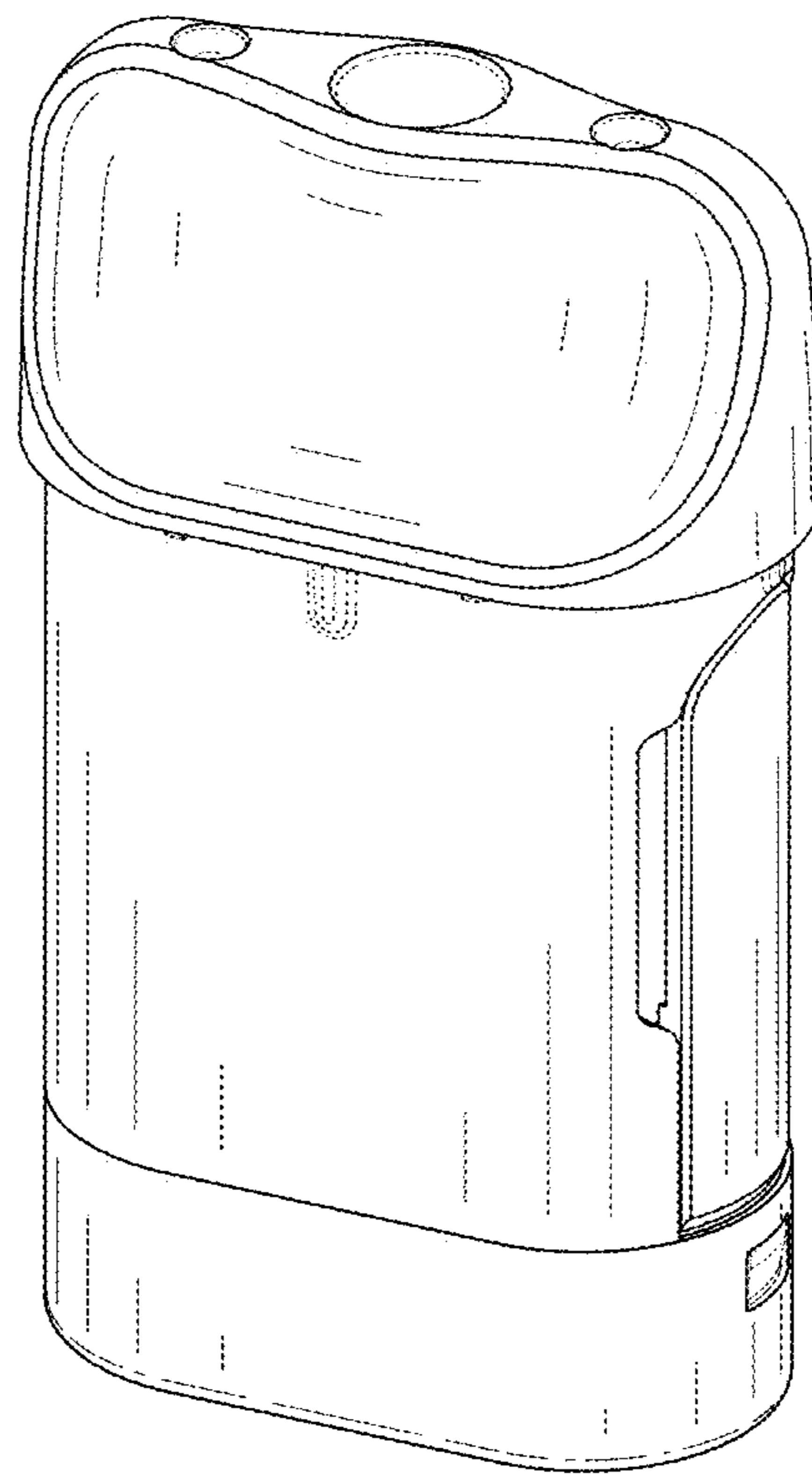

FIG. 9

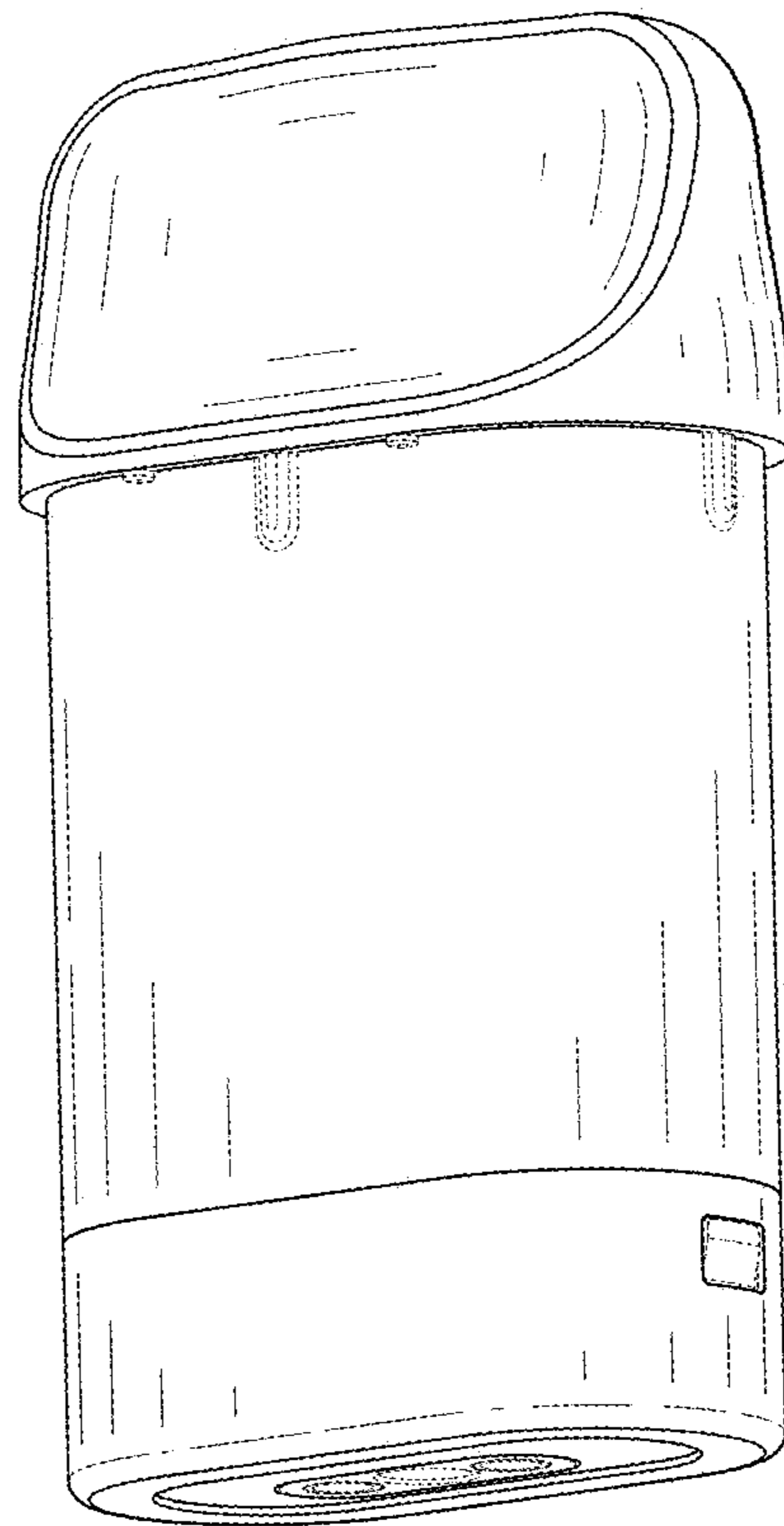

FIG. 10

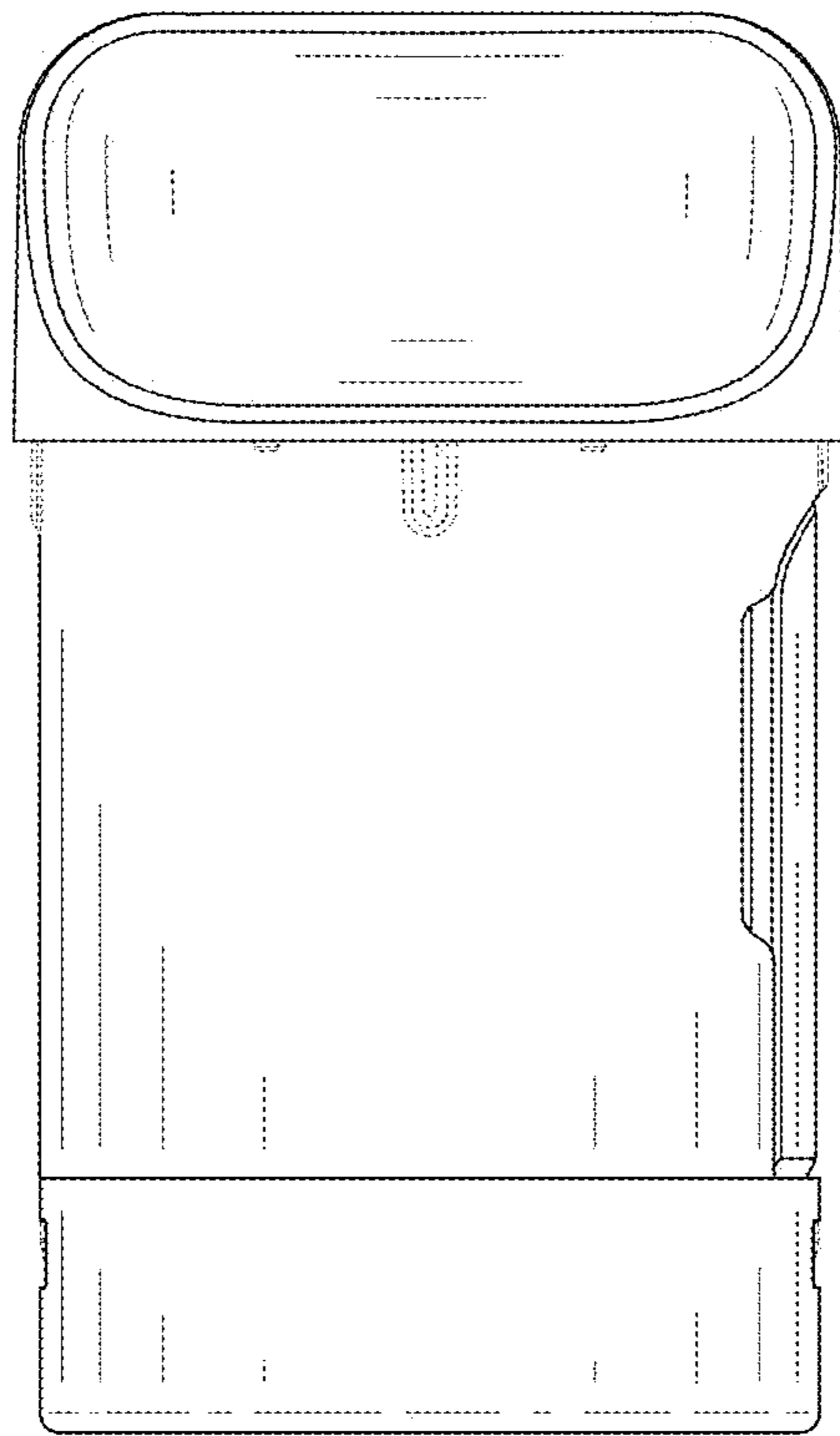

FIG. 11

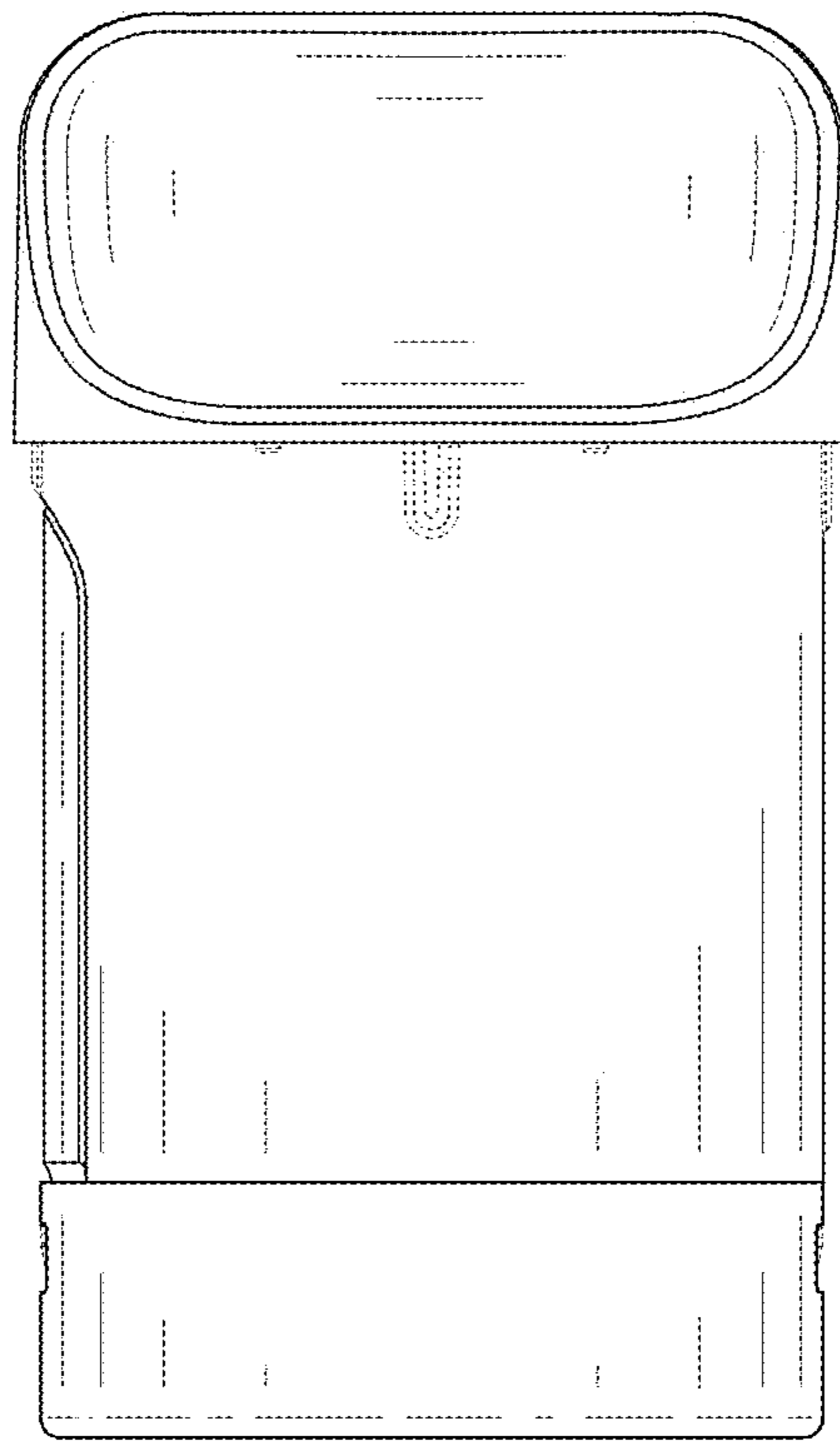

FIG. 12

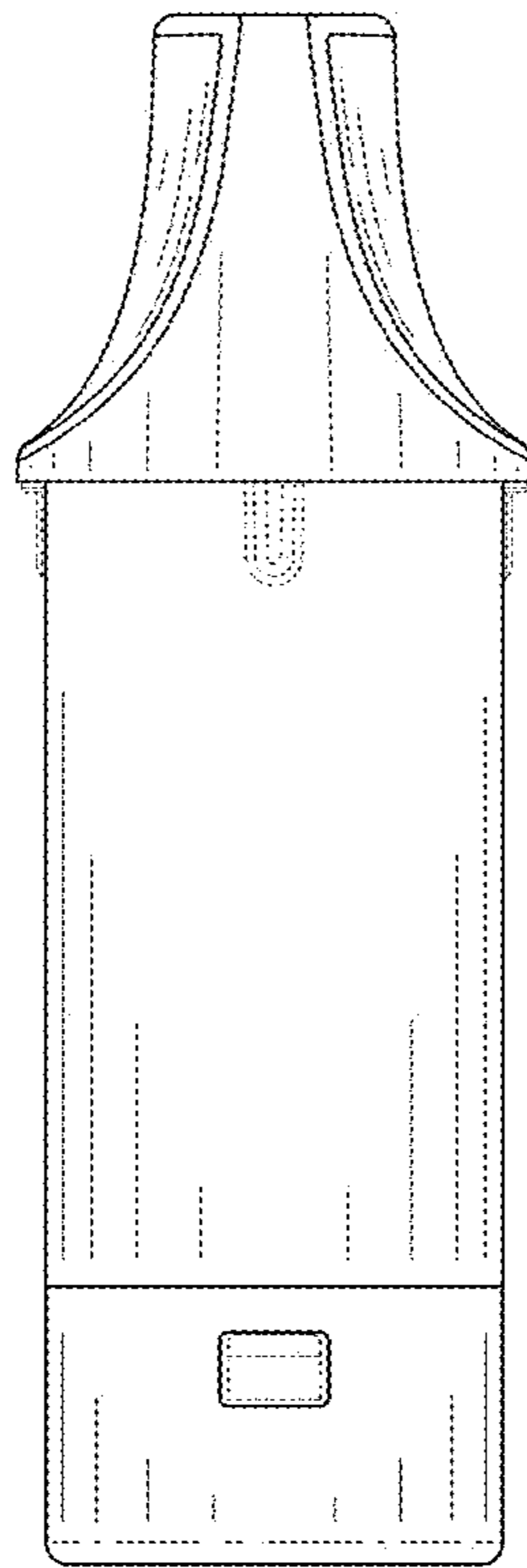

FIG. 13

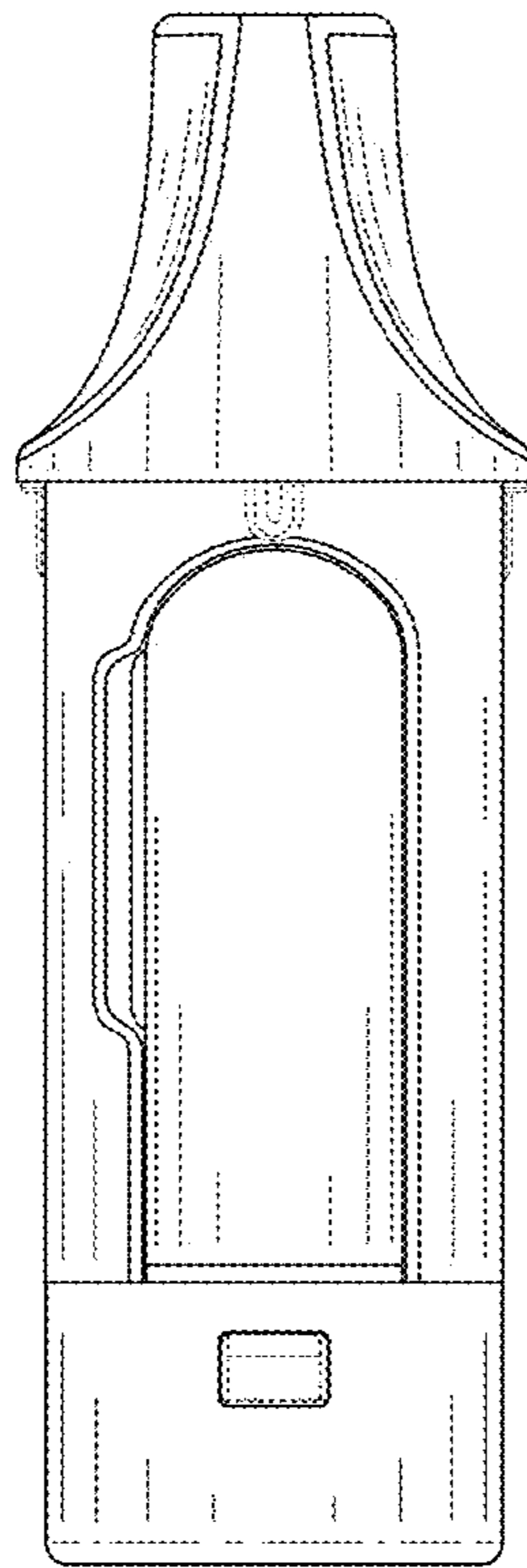

FIG. 14

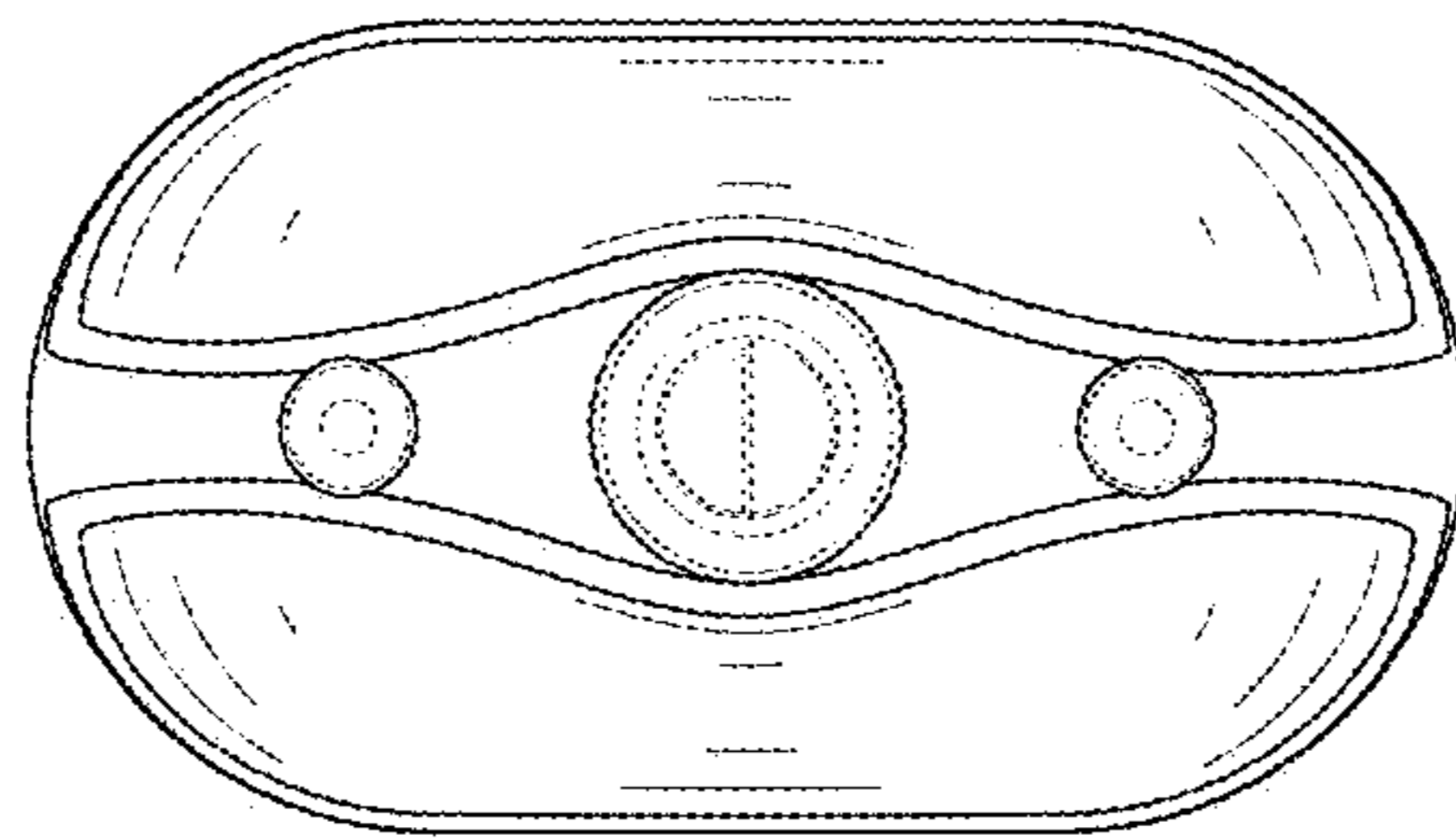

FIG. 15

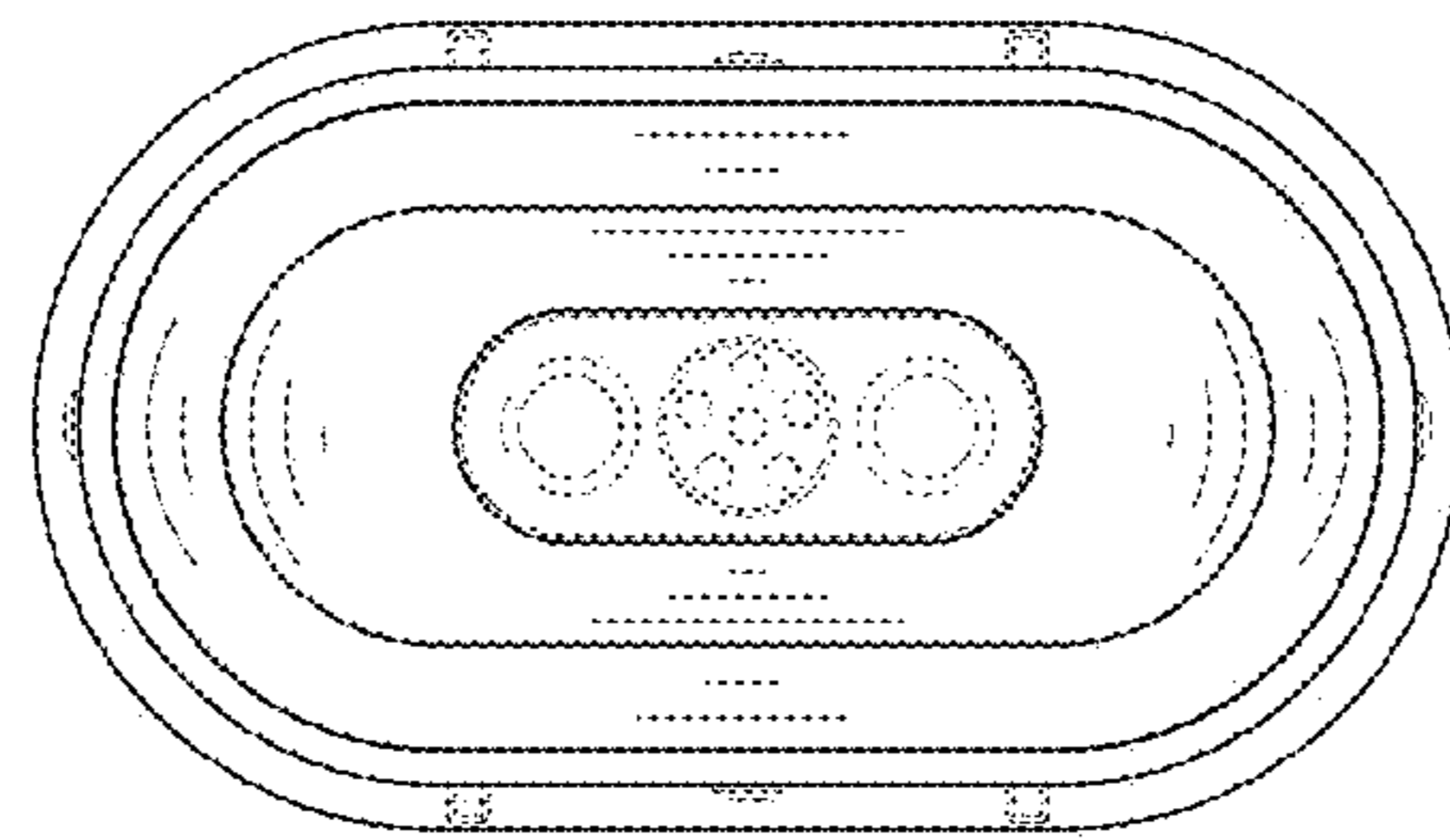

FIG. 16

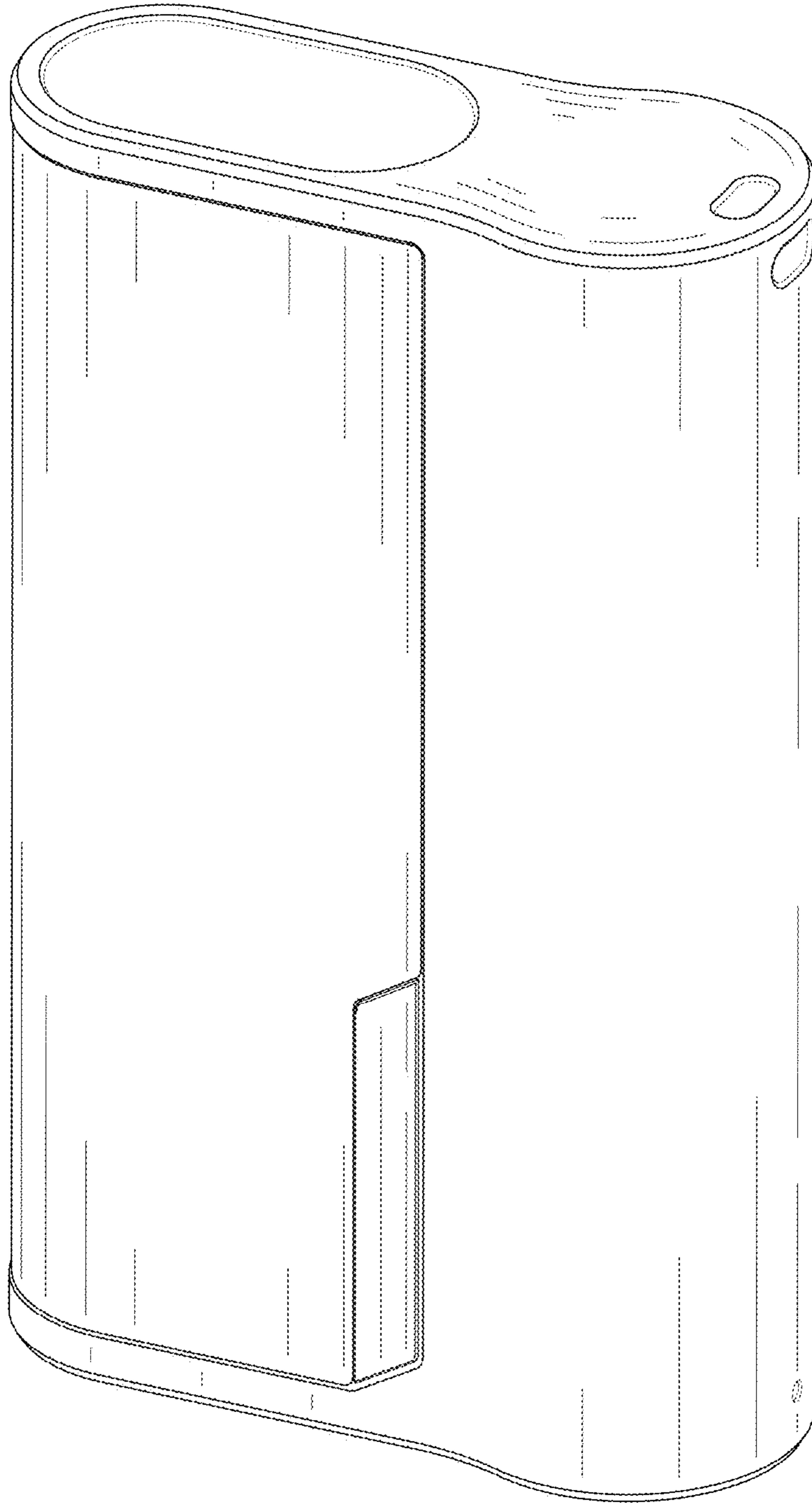

FIG. 17

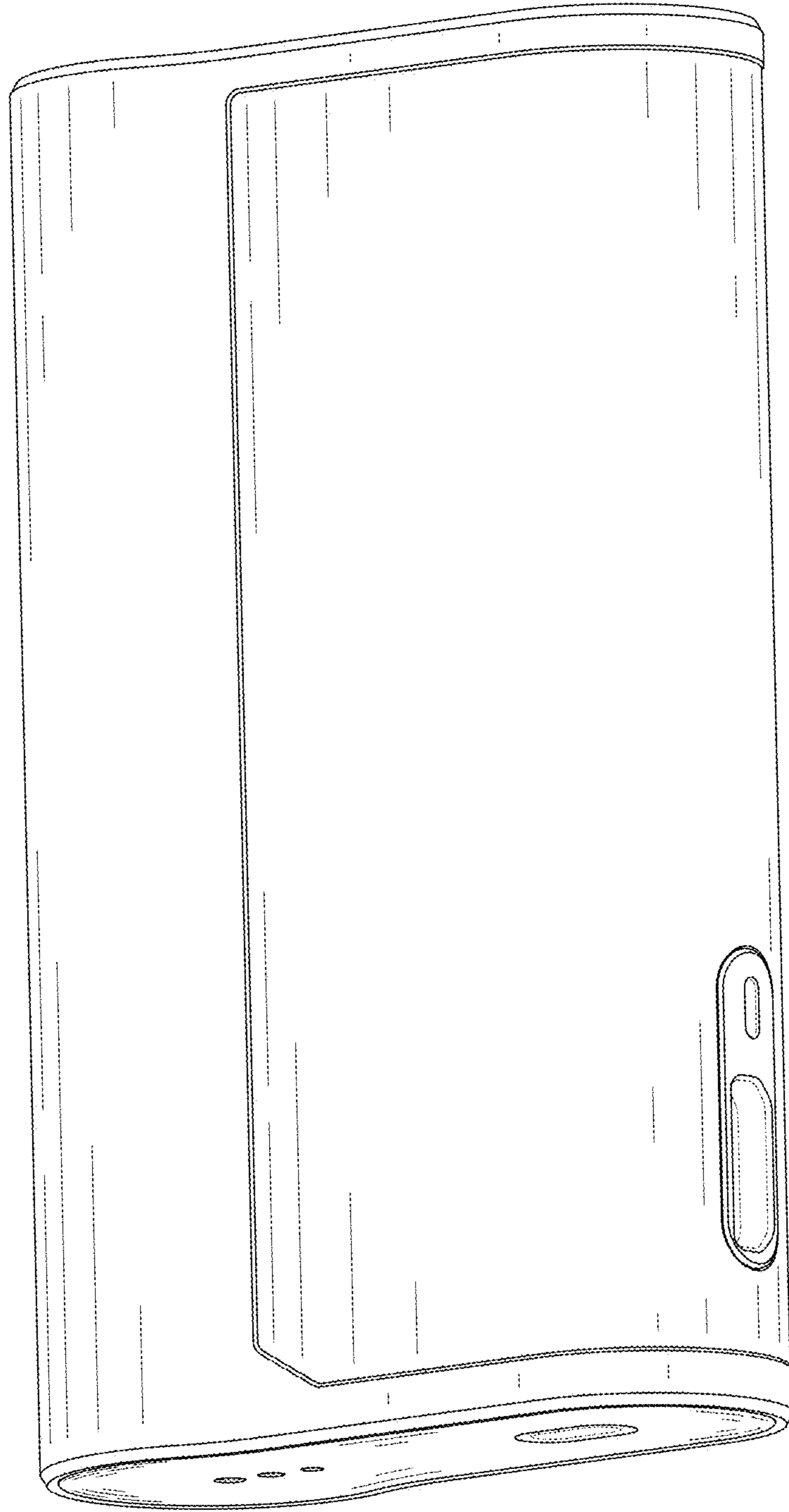

FIG. 18

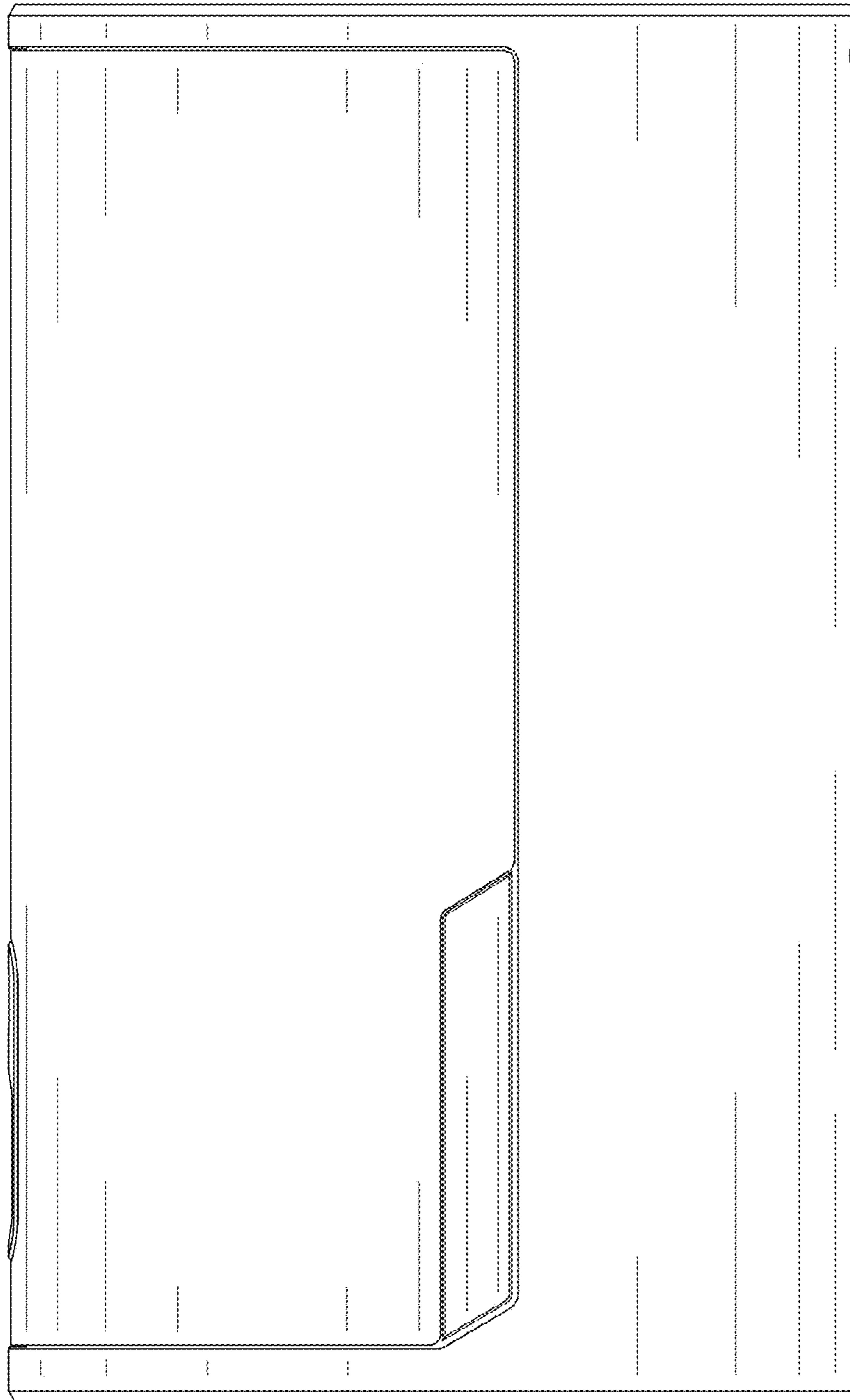

FIG. 19

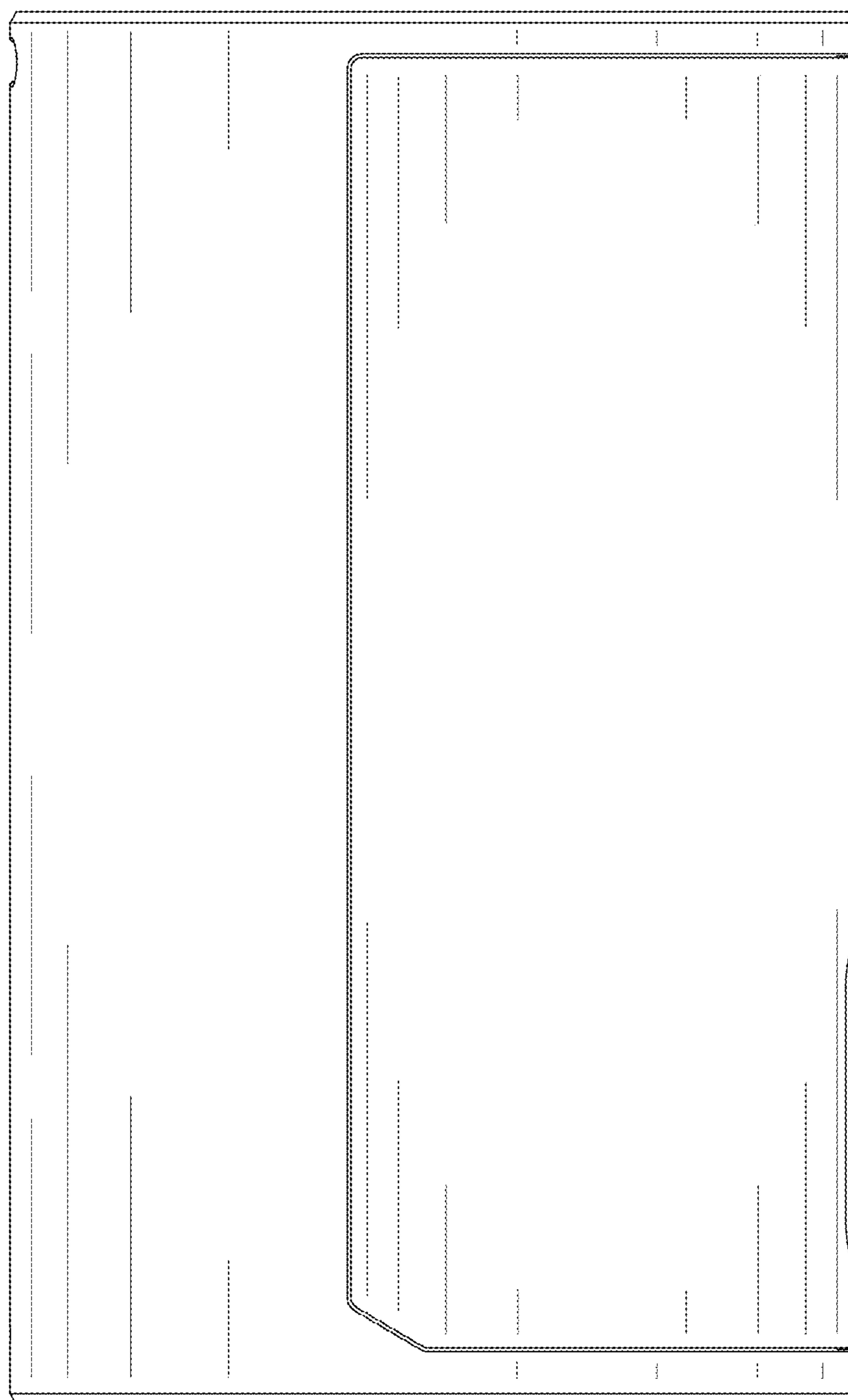

FIG. 20

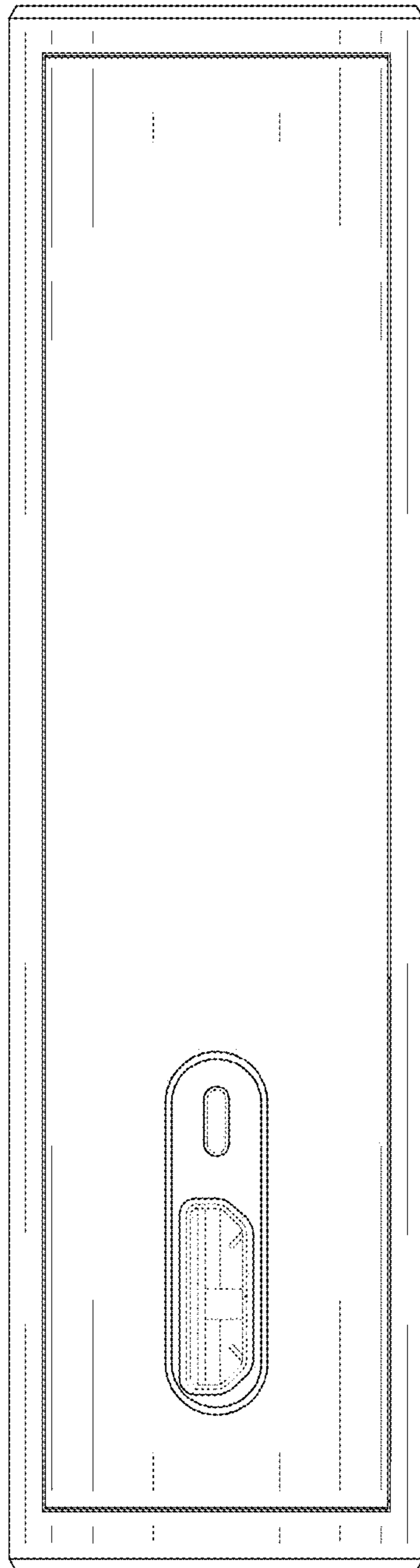

FIG. 21

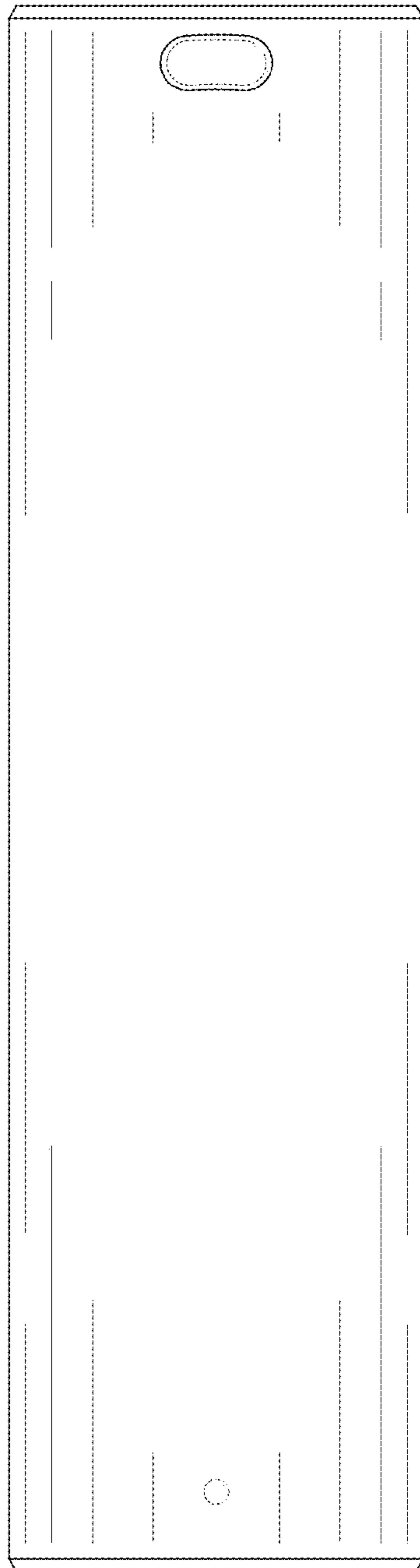

FIG. 22

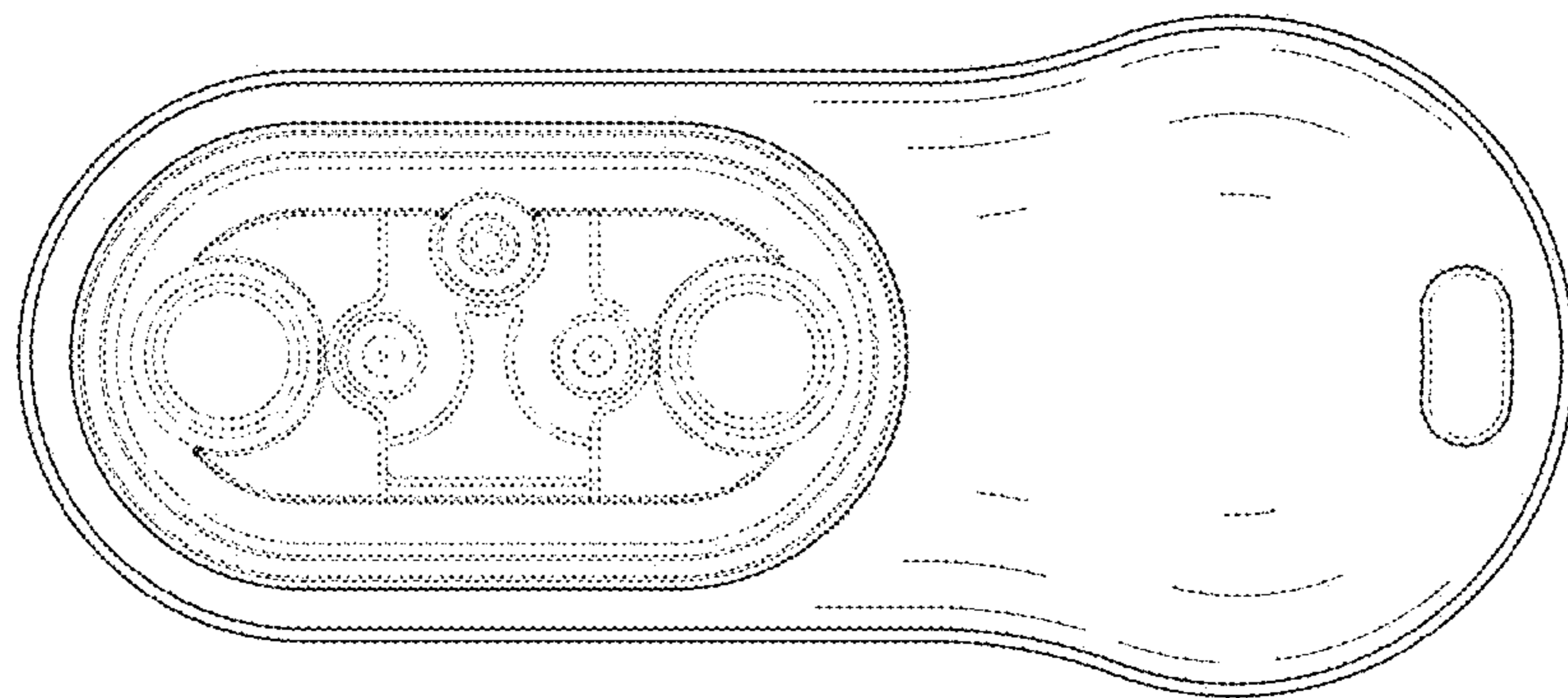

FIG. 23

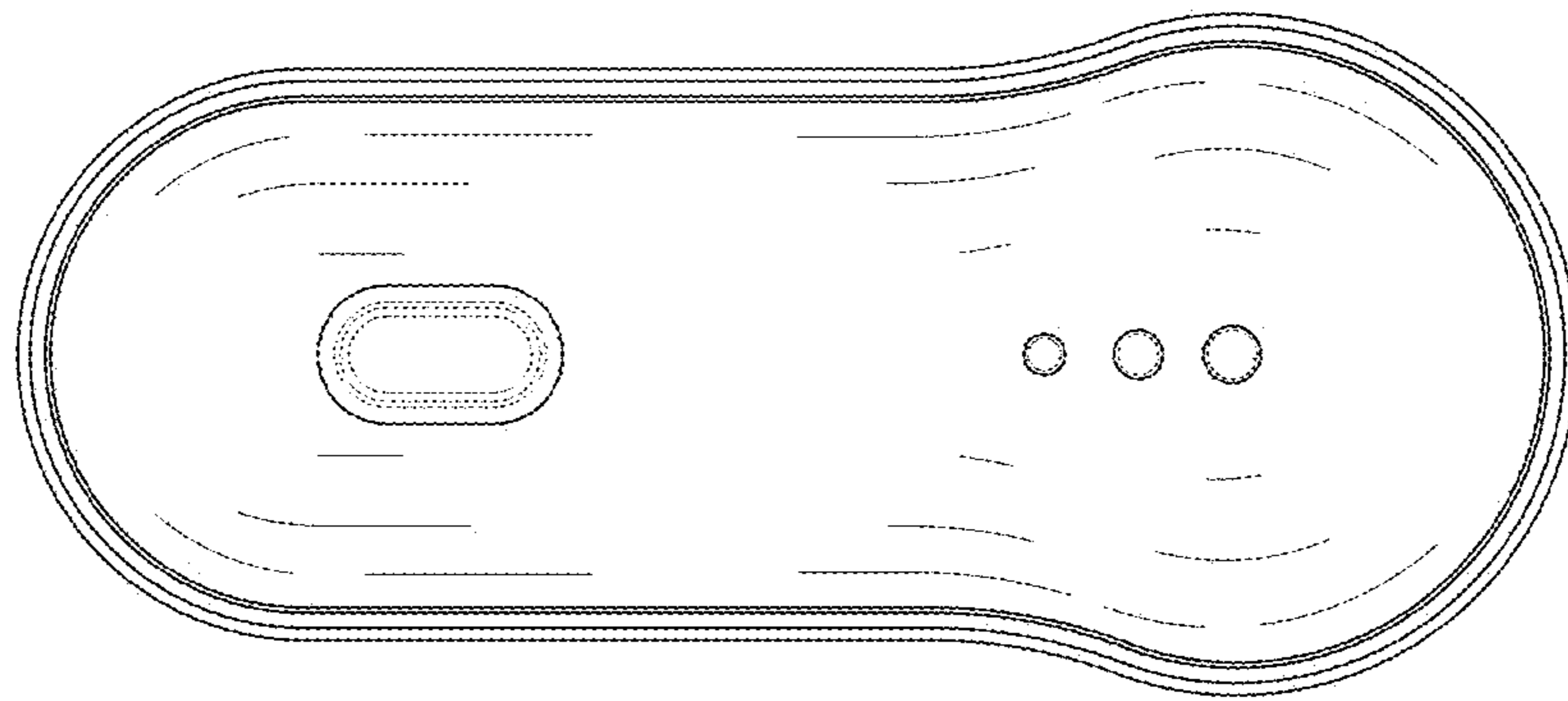

FIG. 24

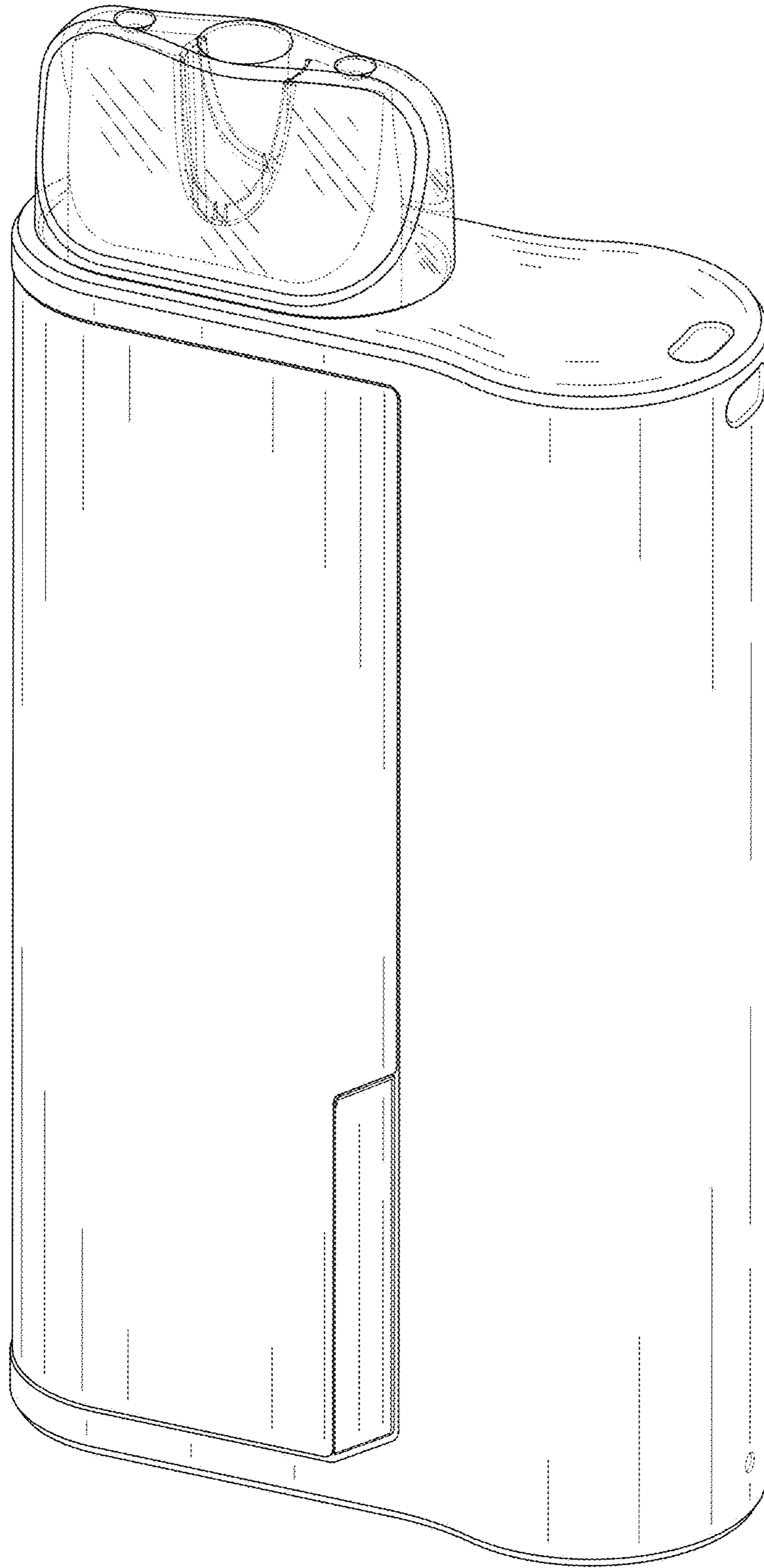

FIG. 25

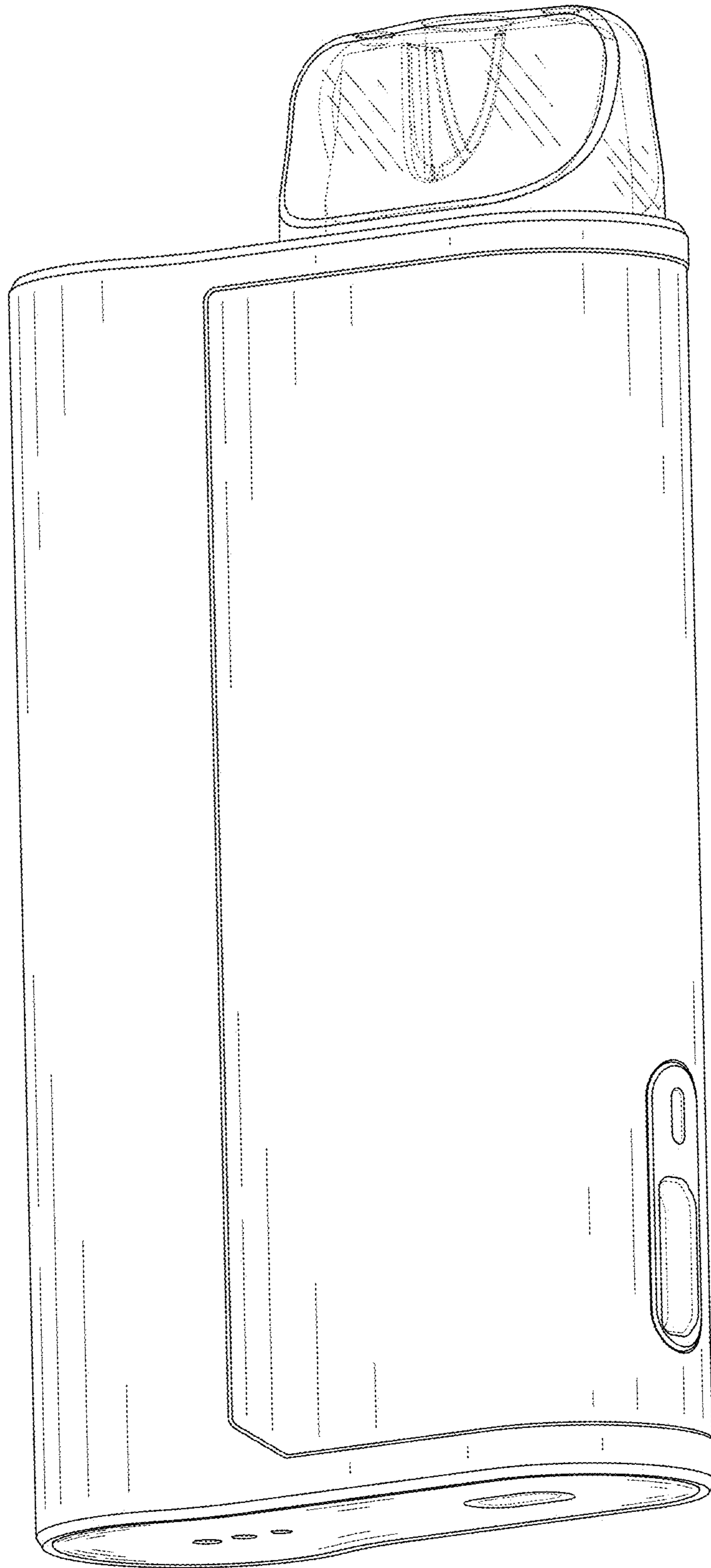

FIG. 26

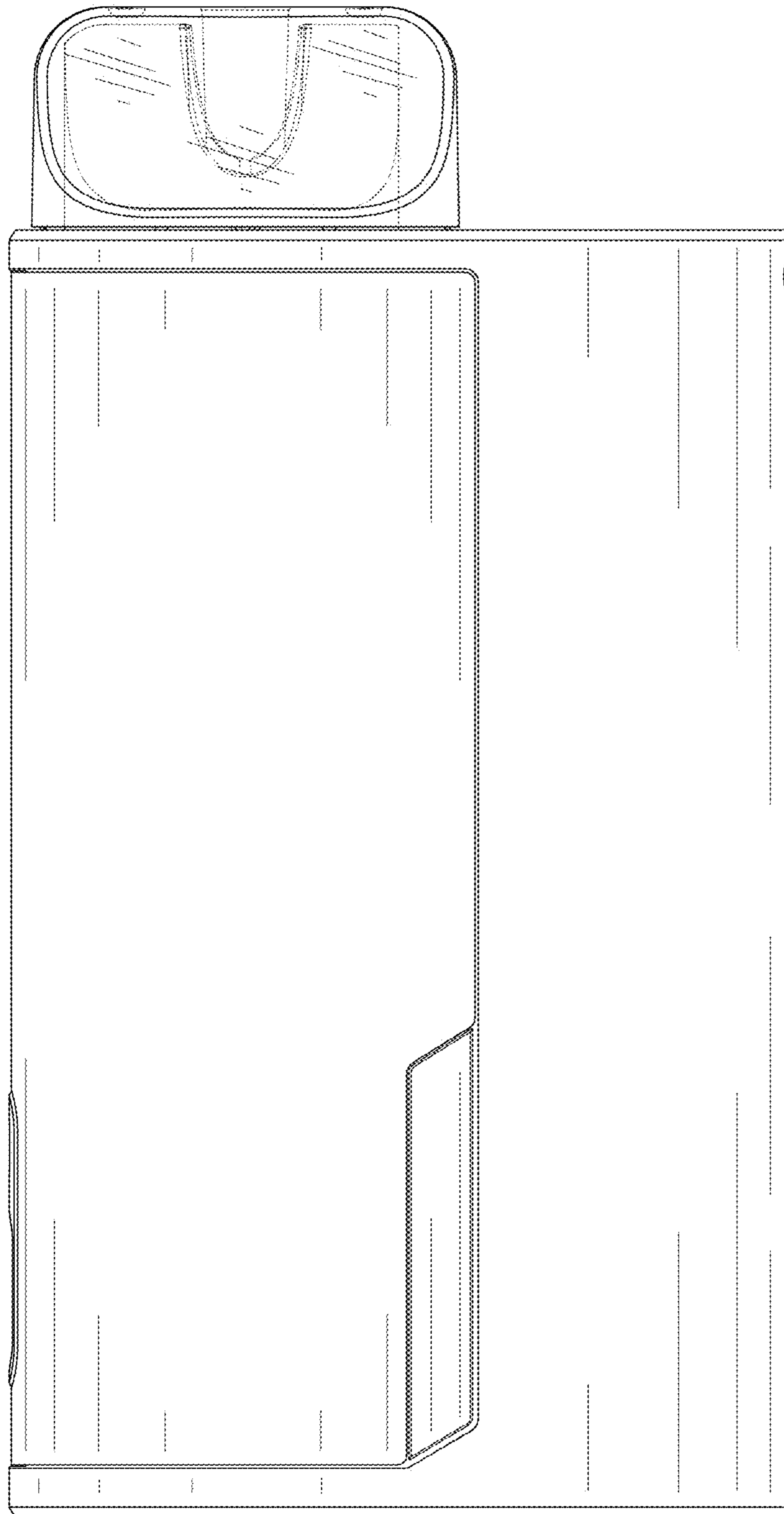

FIG. 27

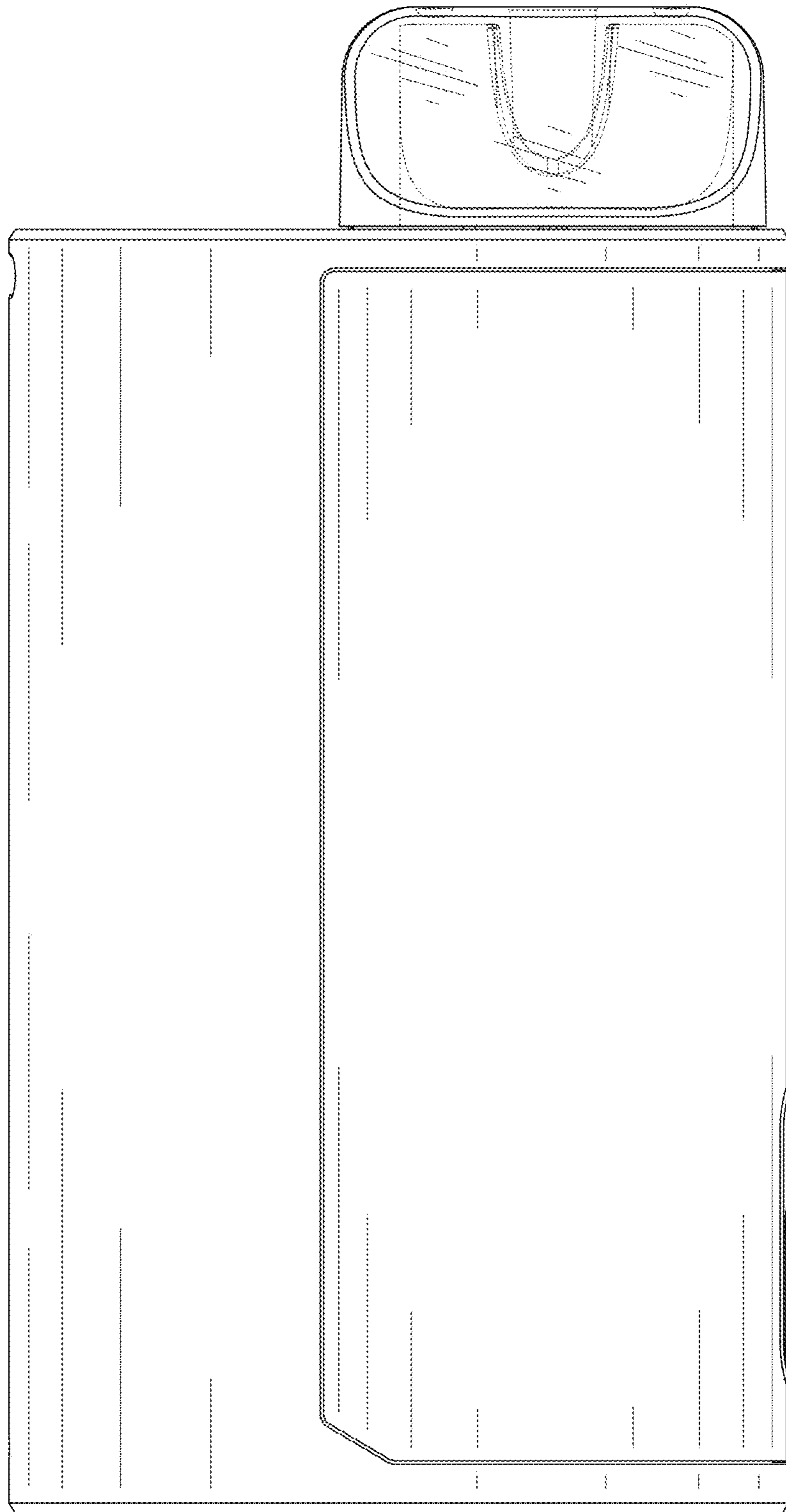

FIG. 28

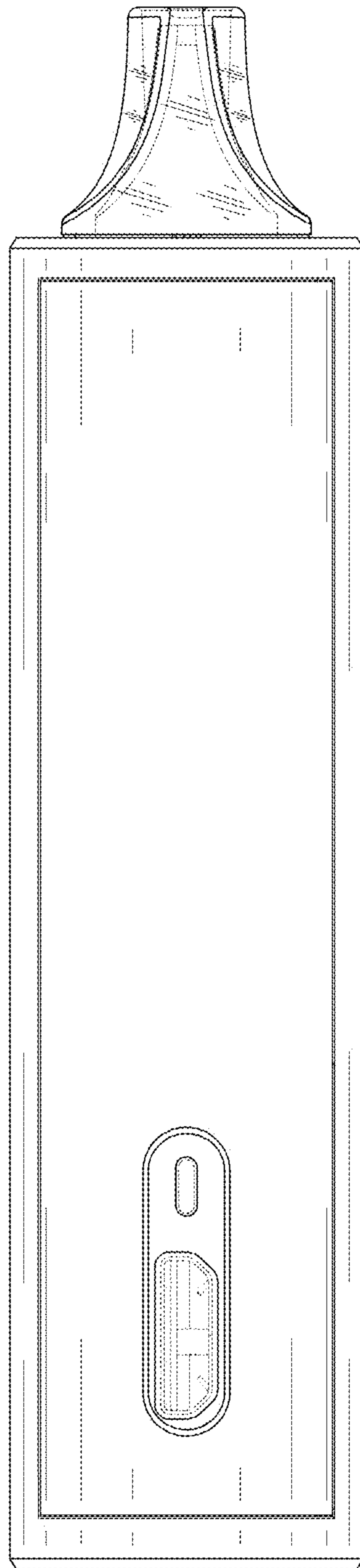

FIG. 29

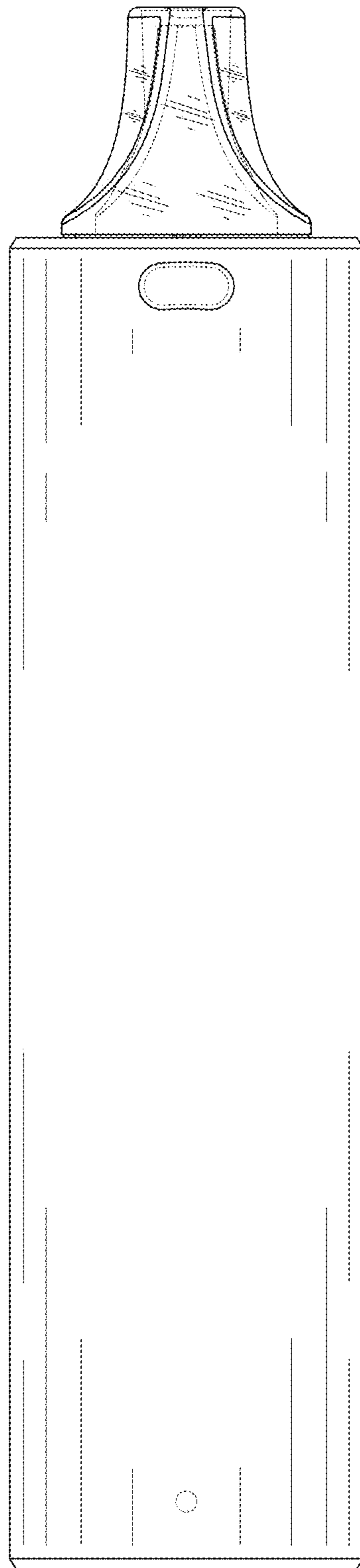

FIG. 30

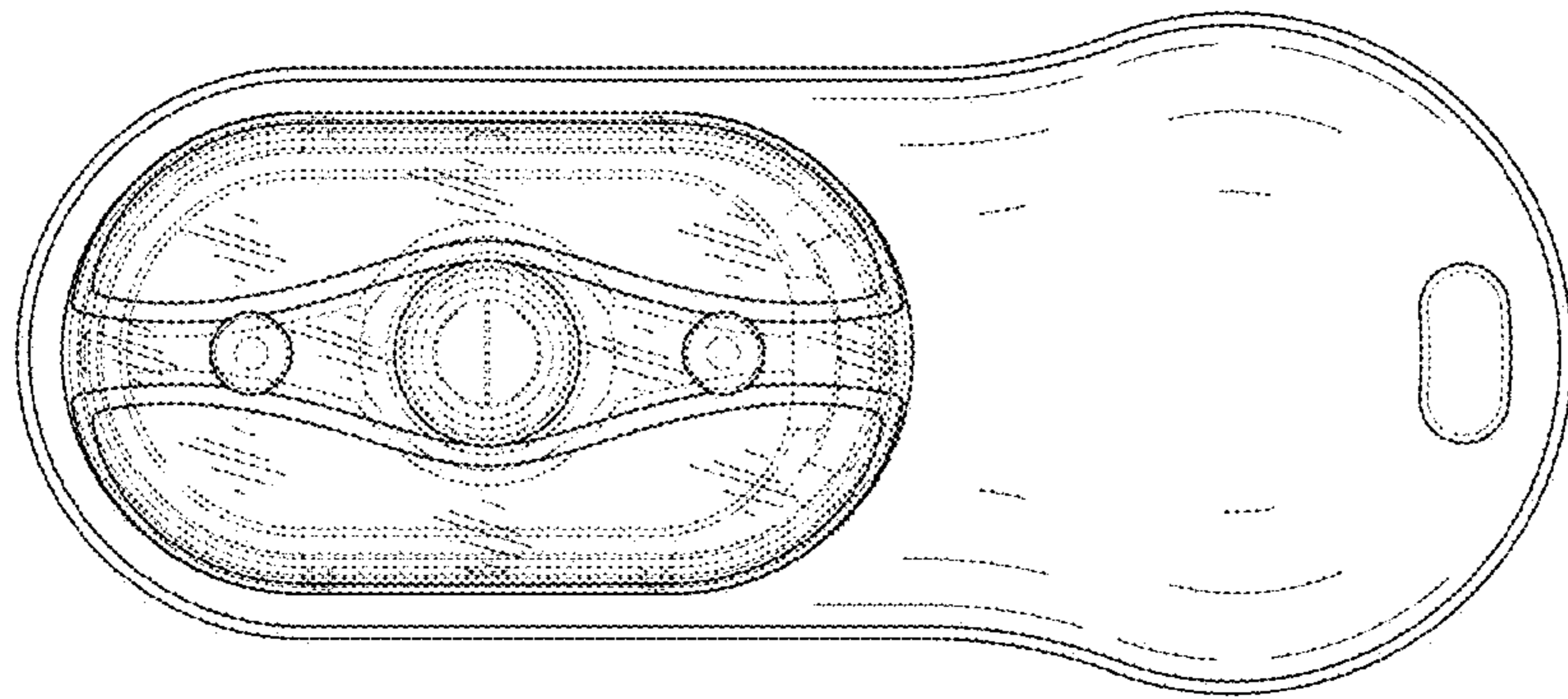

FIG. 31

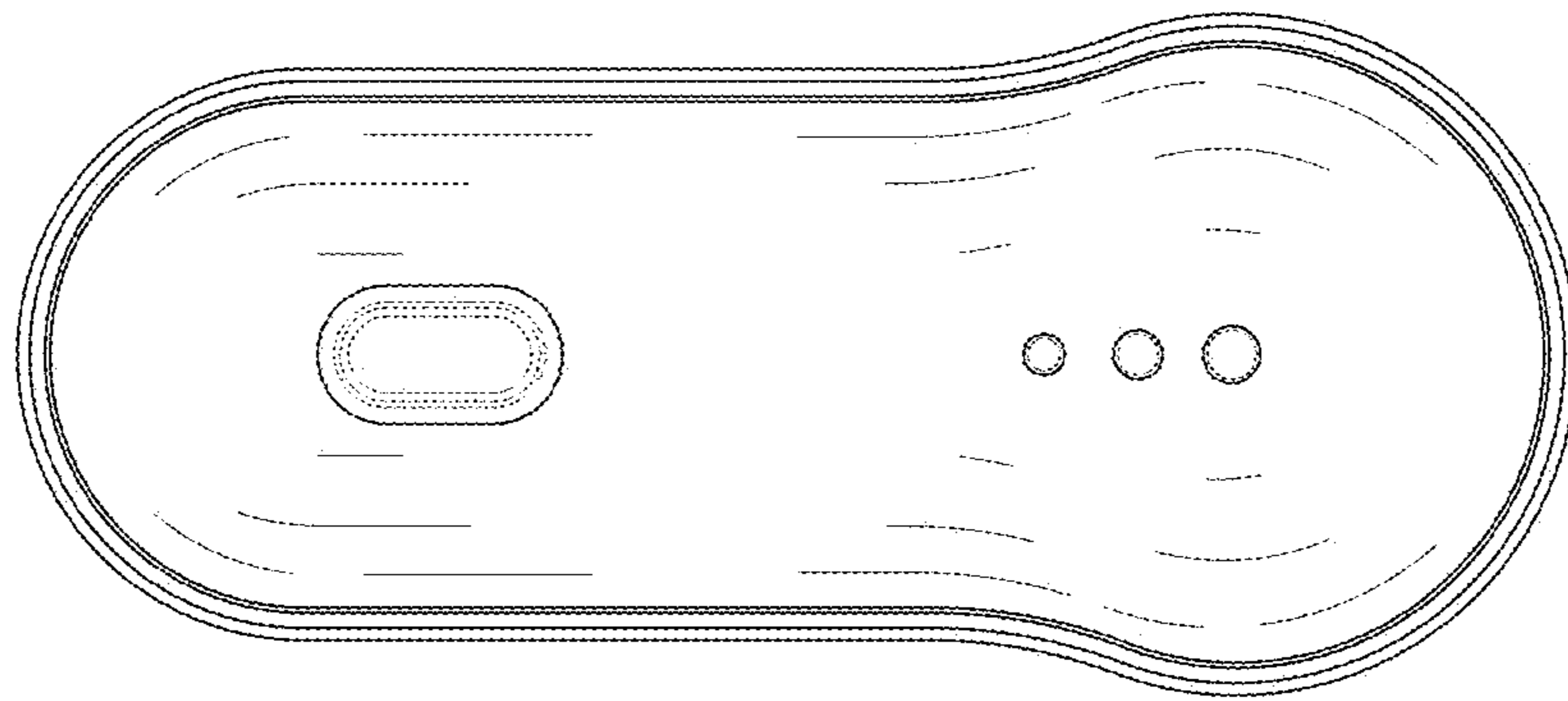

FIG. 32

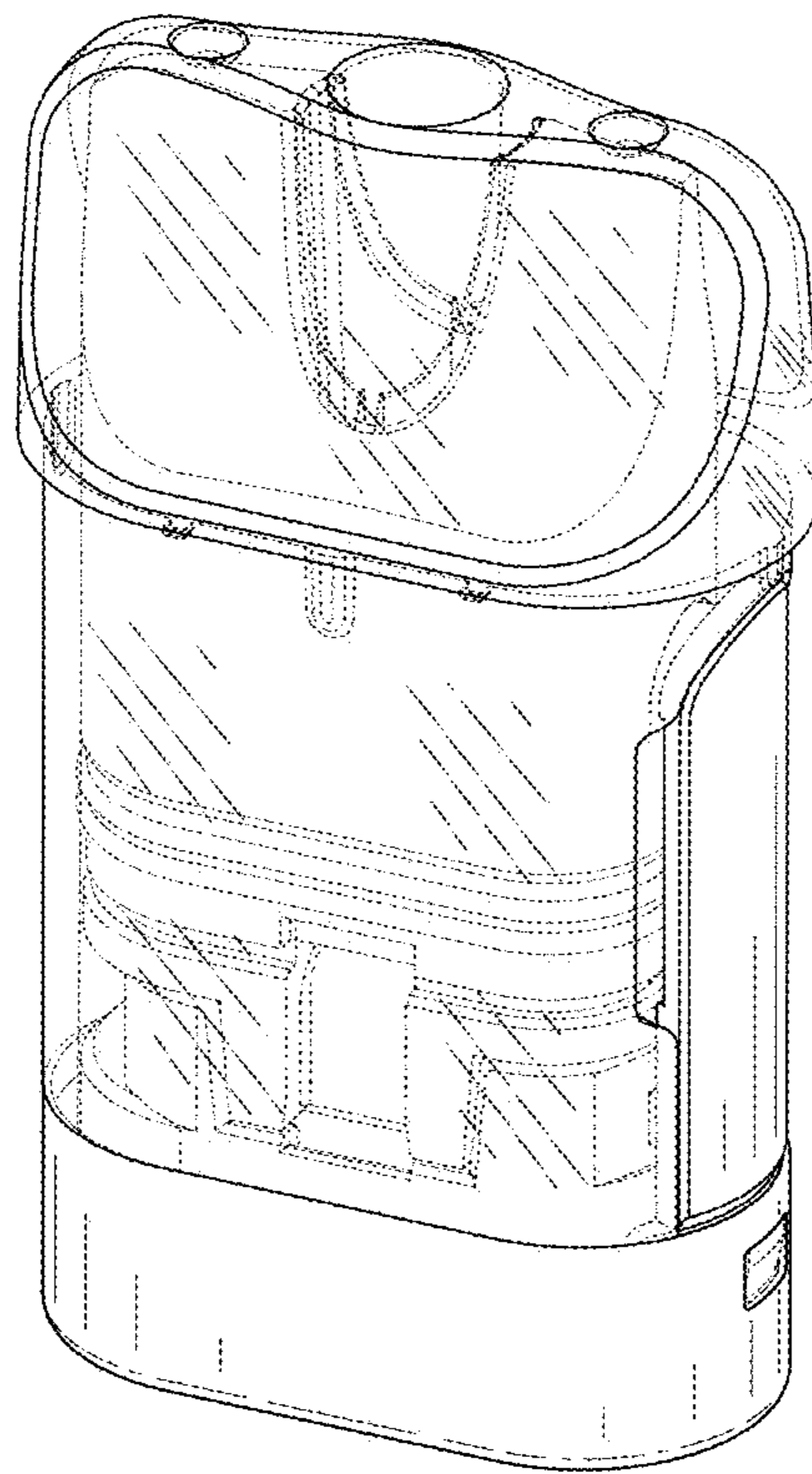

FIG. 33

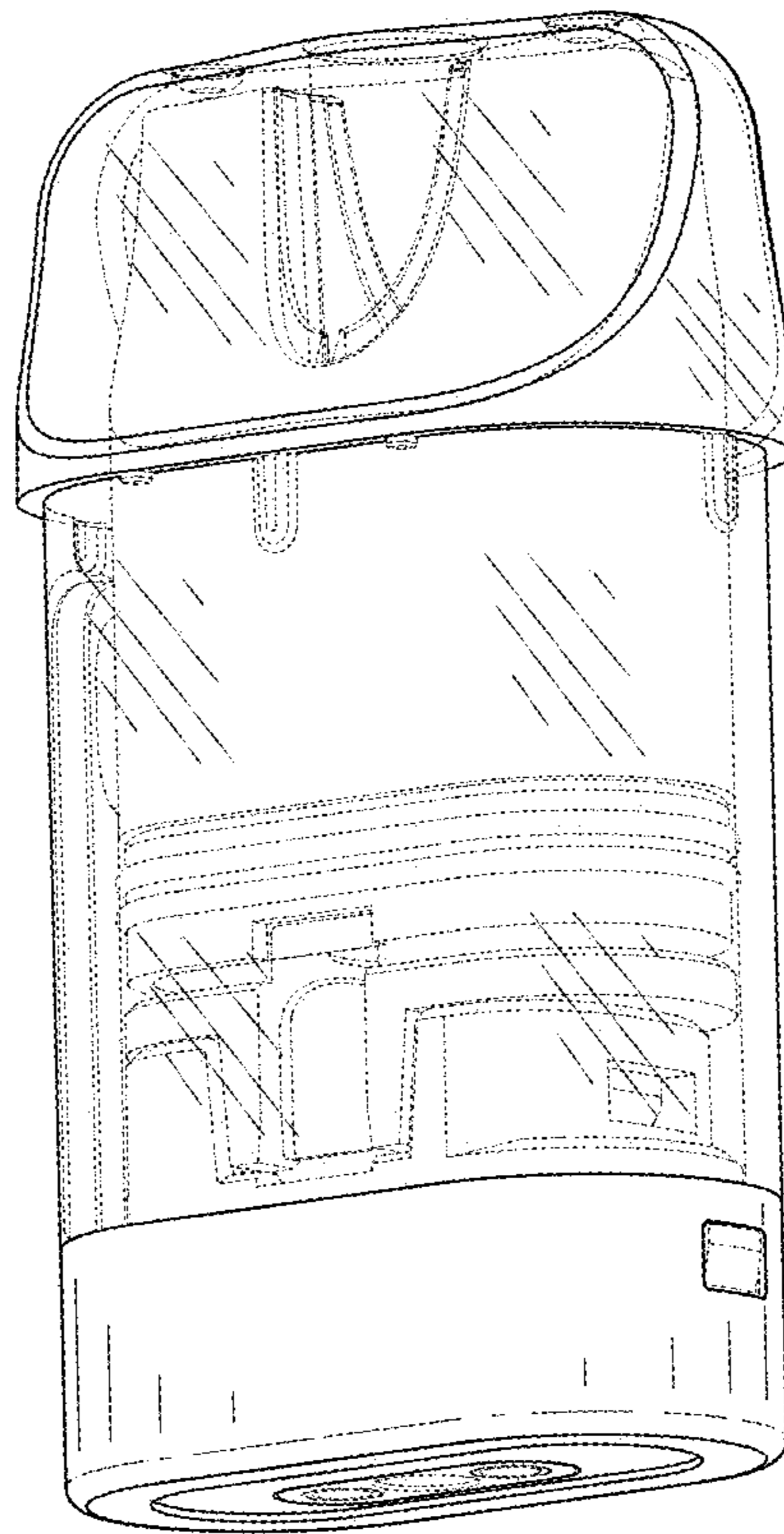

FIG. 34

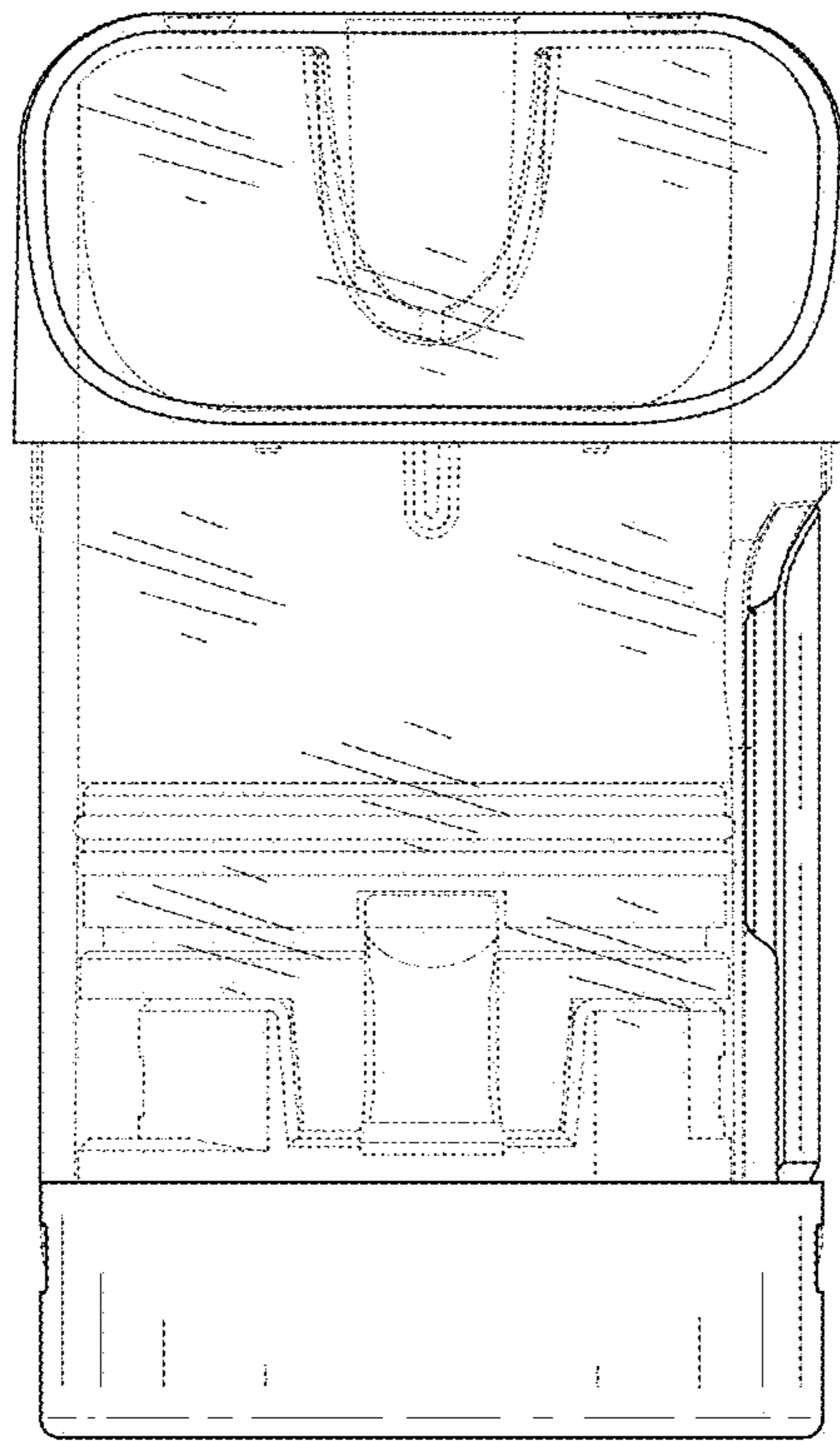

FIG. 35

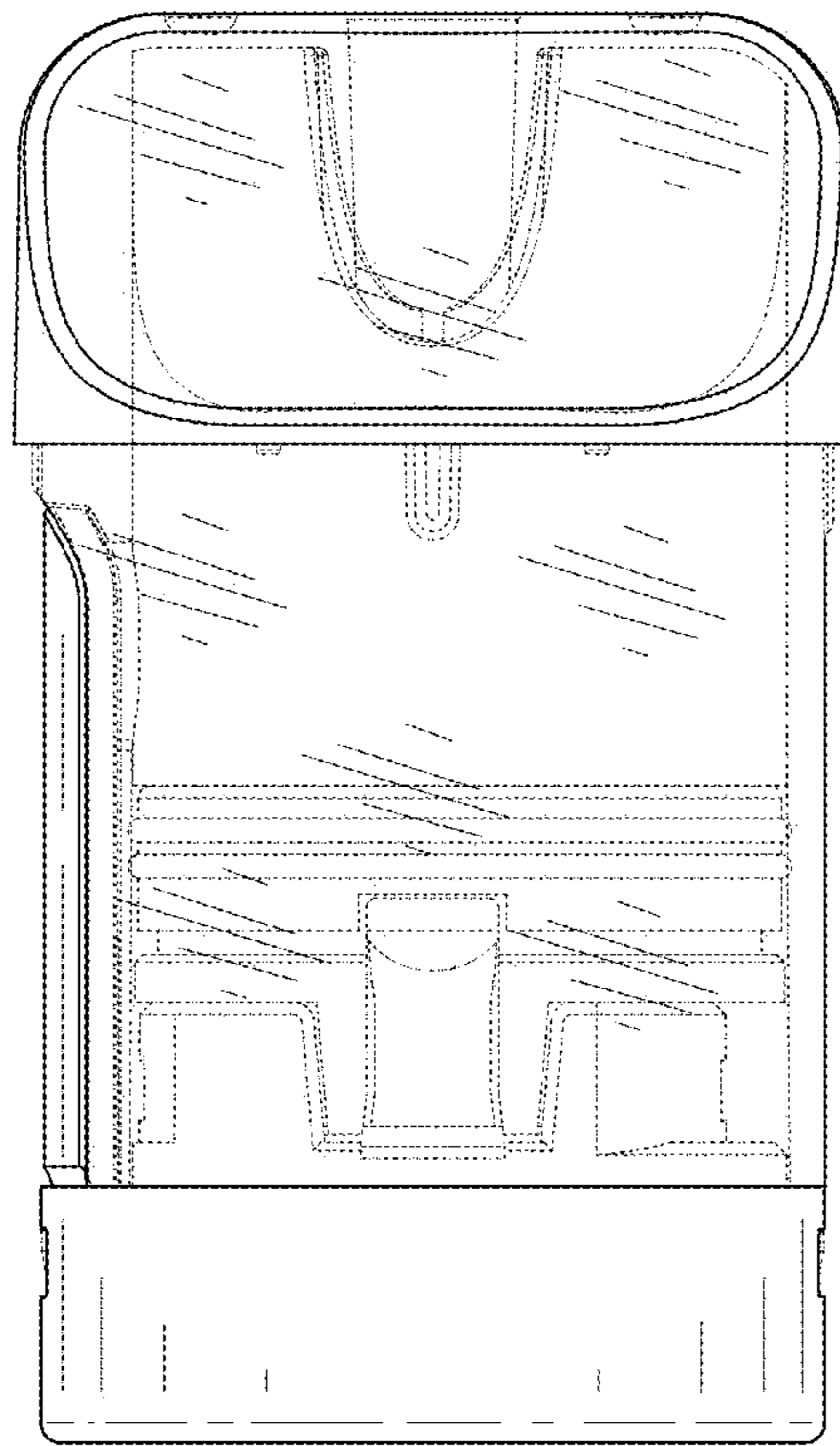

FIG. 36

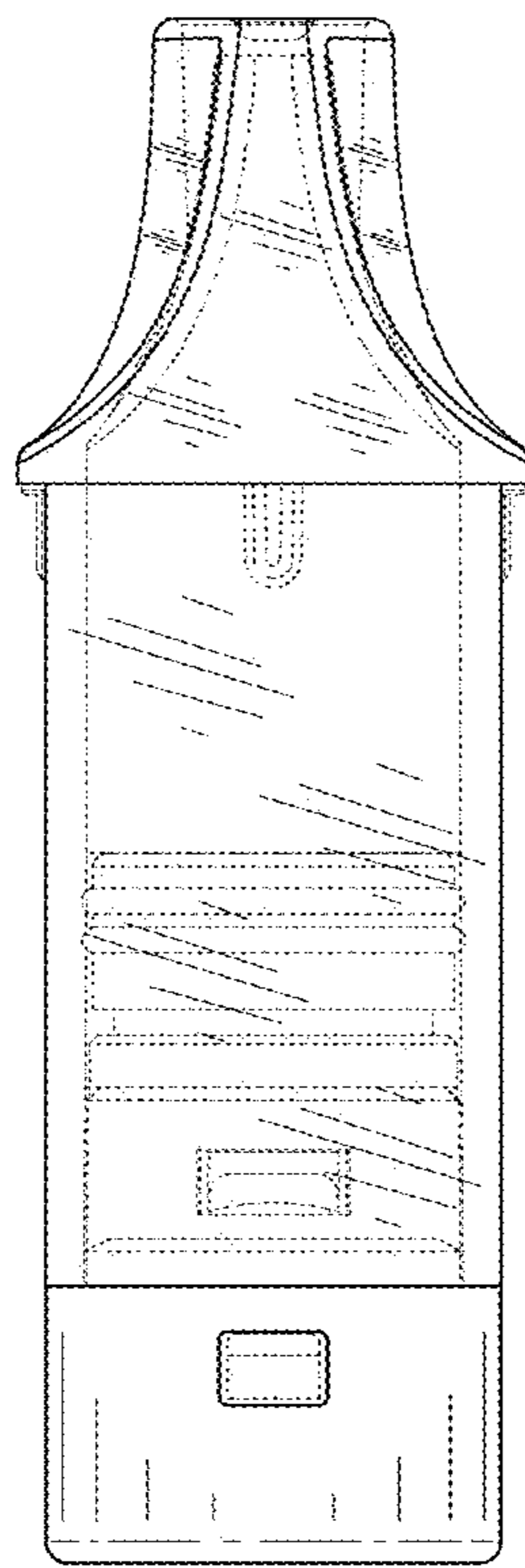

FIG. 37

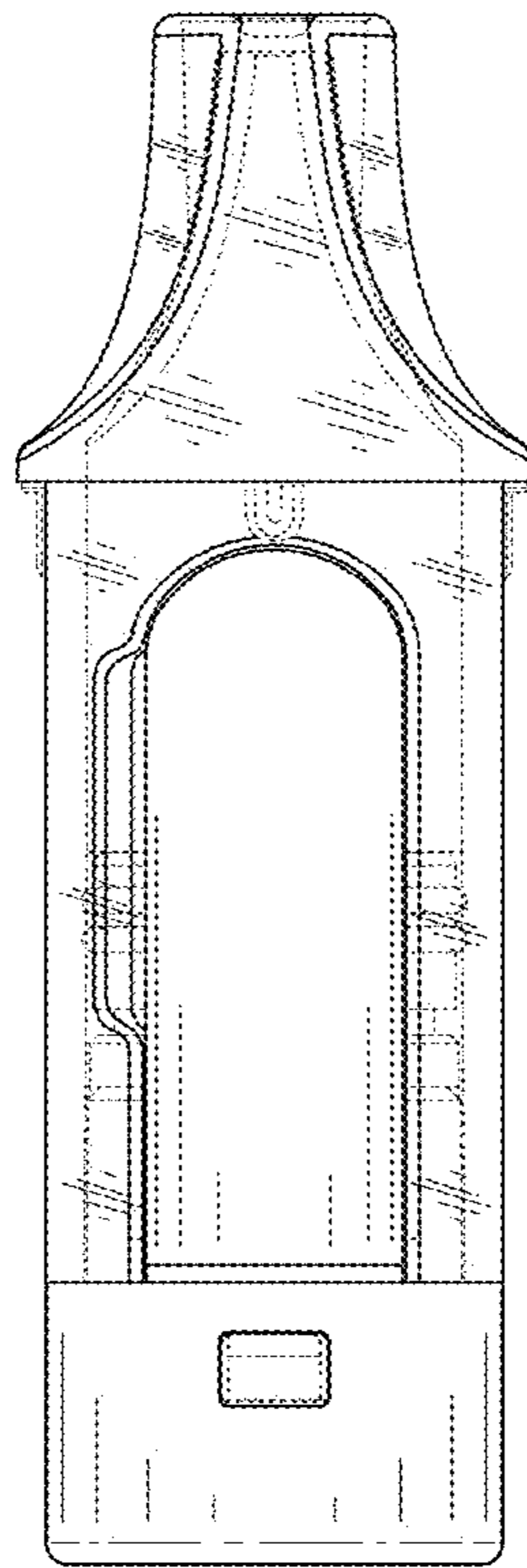

FIG. 38

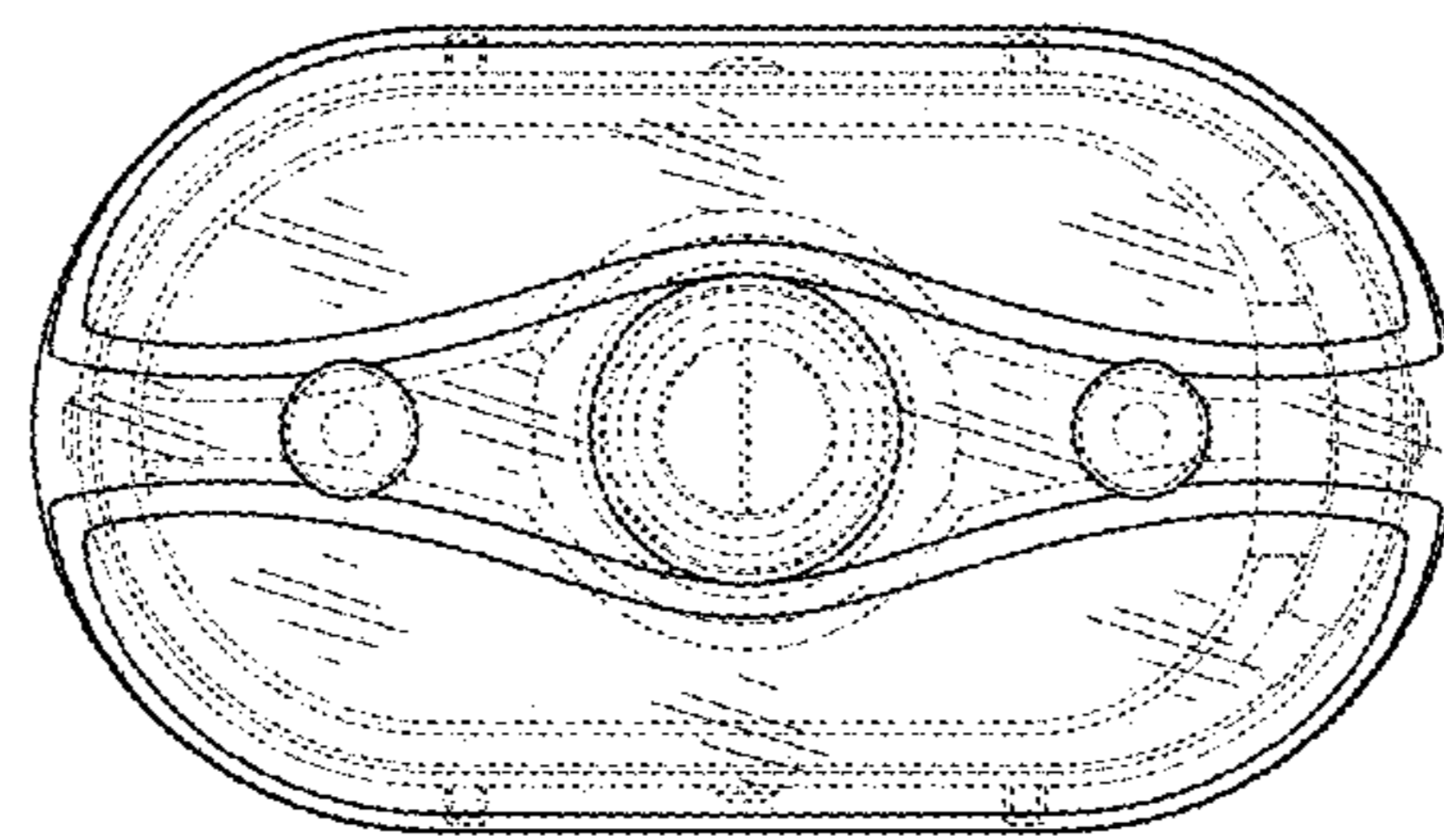

FIG. 39

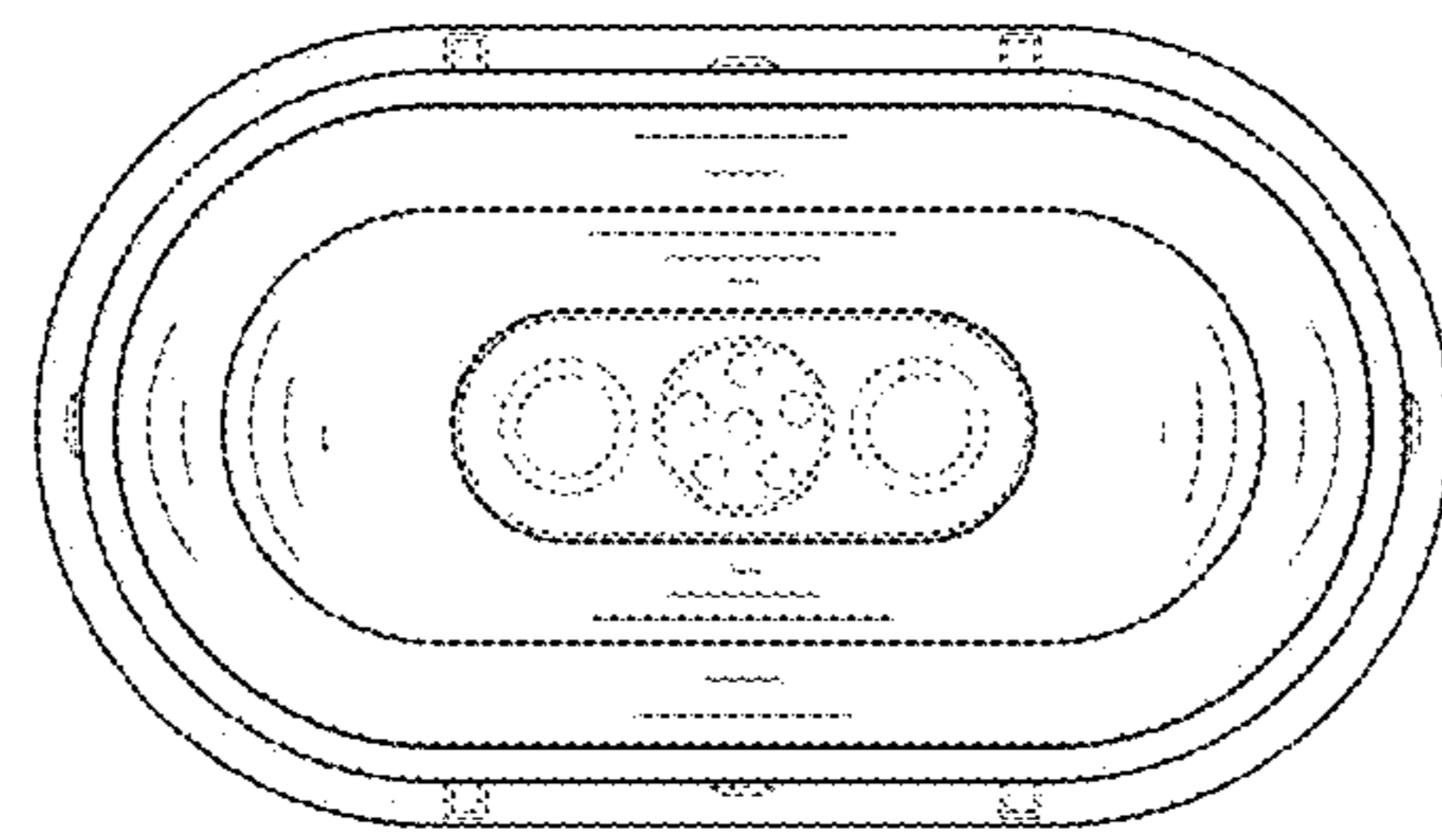

FIG. 40