



US00D924414S

(12) **United States Design Patent** (10) **Patent No.:** **US D924,414 S**
Larsen et al. (45) **Date of Patent:** **** Jul. 6, 2021**

(54) **SPA SHELL**

D859,676 S * 9/2019 Larsen D24/204
D859,677 S * 9/2019 Larsen D24/204
D859,678 S * 9/2019 Larsen D24/204
2019/0014952 A1 * 1/2019 Maclean A47K 3/062

(71) Applicant: **WATKINS MANUFACTURING CORPORATION**, Vista, CA (US)

(72) Inventors: **Christopher Carl Larsen**, Vista, CA (US); **Sage Nathan Baker**, Cardiff, CA (US); **Junko Funaki**, San Diego, CA (US); **Nadya Arnaout**, Laguna Beach, CA (US)

(73) Assignee: **WATKINS MANUFACTURING CORPORATION**

(**) Term: **15 Years**

(21) Appl. No.: **29/658,215**

(22) Filed: **Jul. 30, 2018**

(51) **LOC (13) Cl.** **24-01**

(52) **U.S. Cl.**
USPC **D24/204**

(58) **Field of Classification Search**
USPC D24/201–205, 213; D23/276–278, D23/280.1–280.3; D25/2
CPC A61H 33/6005; A61H 33/6021; A61H 33/6089; A61H 33/6094; A61H 2035/004; A61H 35/006; A47K 3/022; A47K 3/062
See application file for complete search history.

(56) **References Cited**

U.S. PATENT DOCUMENTS

D322,661 S * 12/1991 Dannenberg D23/280.1
D428,995 S * 8/2000 Magray D24/201
D543,283 S * 5/2007 Larsen D24/204
D614,776 S * 4/2010 Loyd D24/204
D643,539 S * 8/2011 Larsen D24/204
D660,442 S * 5/2012 Sullivan D24/201
D810,954 S * 2/2018 Larsen D24/204
D851,268 S * 6/2019 Larsen D24/204
D859,675 S * 9/2019 Larsen D24/204

FOREIGN PATENT DOCUMENTS

CH 144427-0001 * 1/2019

* cited by examiner

Primary Examiner — Lilyana Bekic

Assistant Examiner — Mary Shannon Malley

(74) *Attorney, Agent, or Firm* — Kirk W. Rudolph

(57) **CLAIM**

The ornamental design for a spa shell, as shown and described.

DESCRIPTION

FIG. 1 is a perspective view of a spa shell showing our new design;
FIG. 2 is another perspective view thereof;
FIG. 3 is a top plan view thereof;
FIG. 4 is a cross-sectional view thereof, taken in the direction of line 4-4 of FIG. 3;
FIG. 5 is a cross-sectional view thereof, taken in the direction of line 5-5 of FIG. 3;
FIG. 6 is a cross-sectional view thereof, taken in the direction of line 6-6 of FIG. 3;
FIG. 7 is a cross-sectional view thereof, taken in the direction of line 7-7 of FIG. 3;
FIG. 8 is a cross-sectional view thereof, taken in the direction of line 8-8 of FIG. 3; and,
FIG. 9 is a cross-sectional view thereof, taken in the direction of line 9-9 of FIG. 3.
The broken lines show portions of the spa shell that form no part of the claimed design.

1 Claim, 7 Drawing Sheets

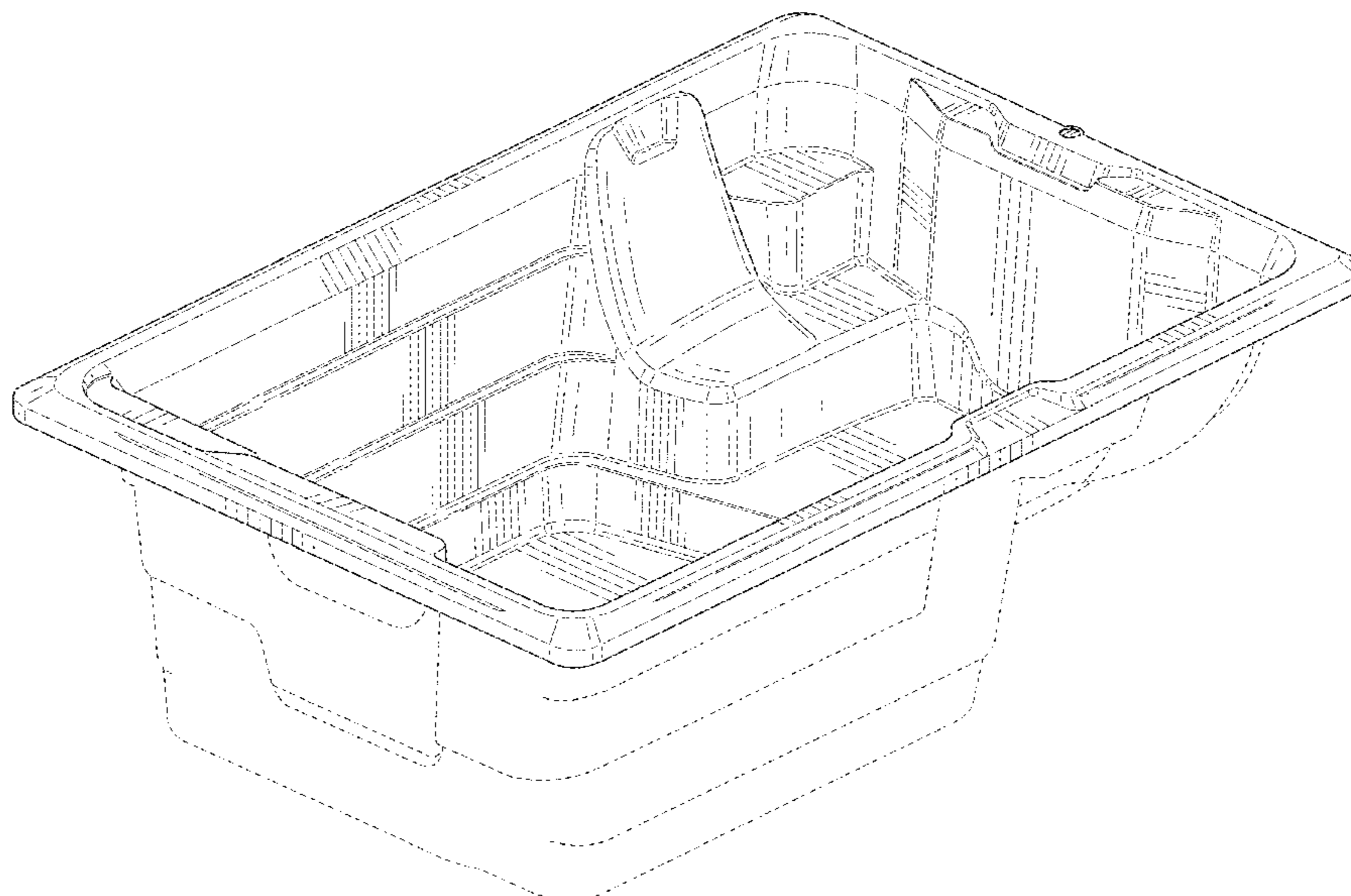

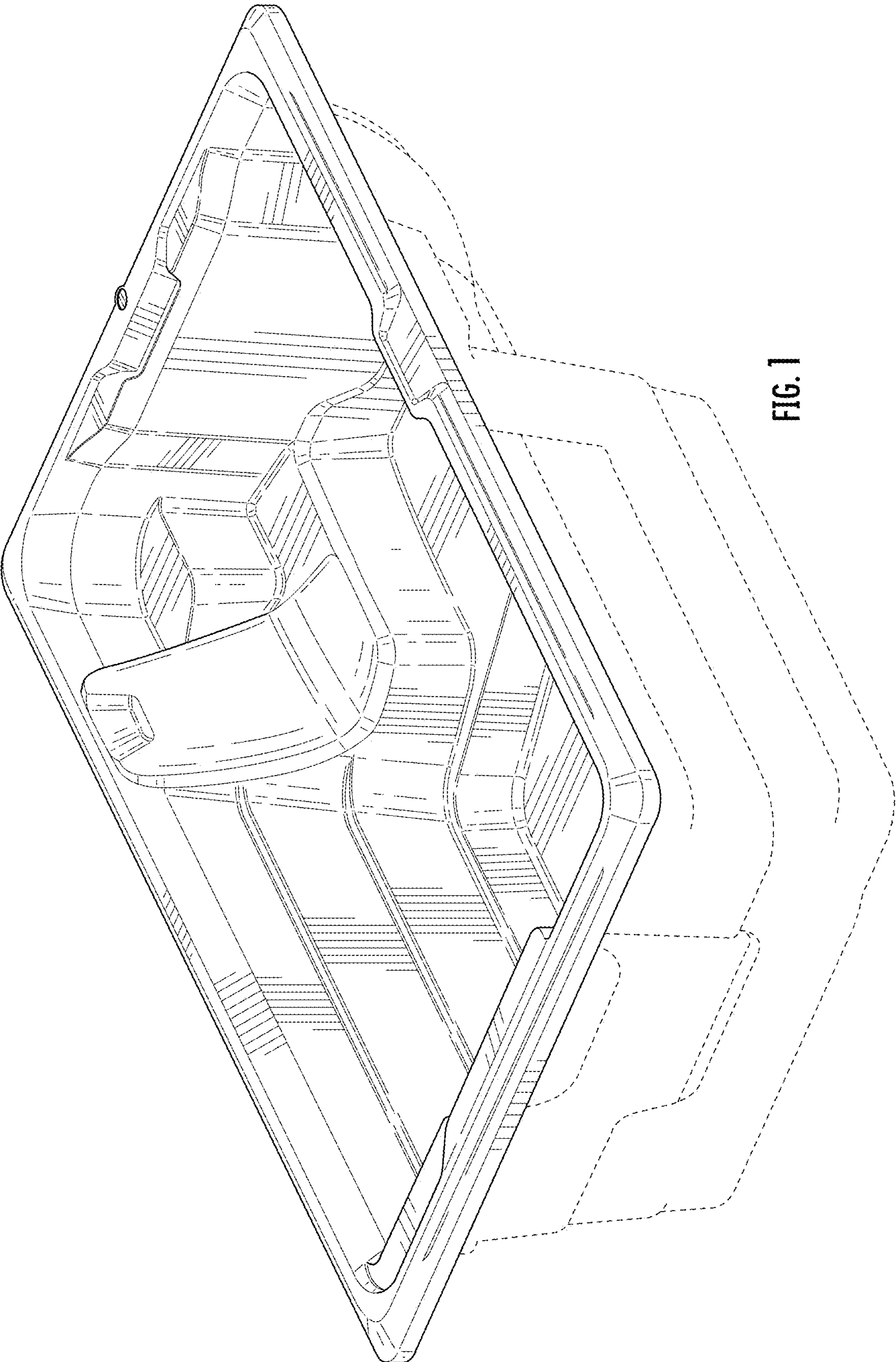

FIG. 1

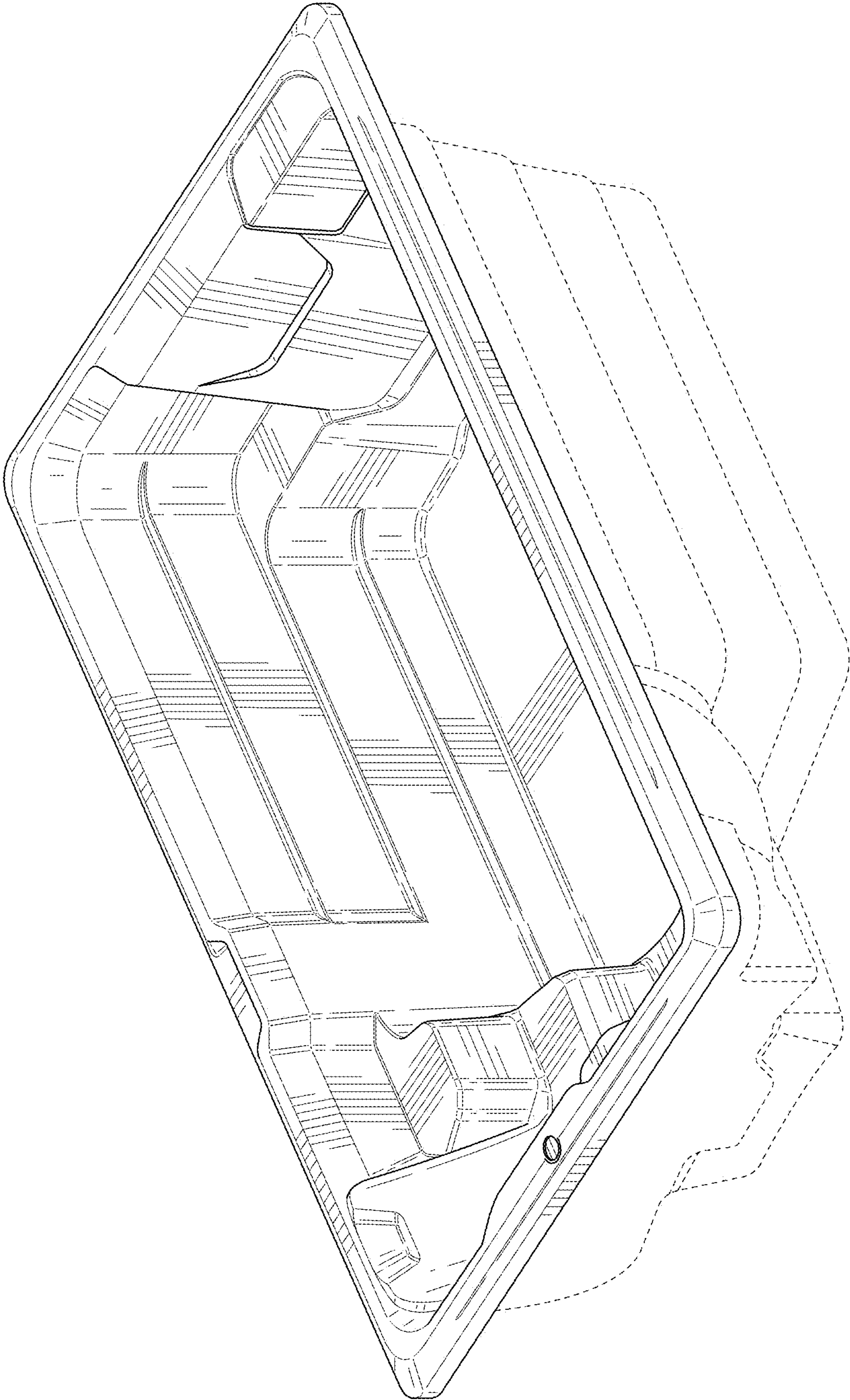

FIG. 2

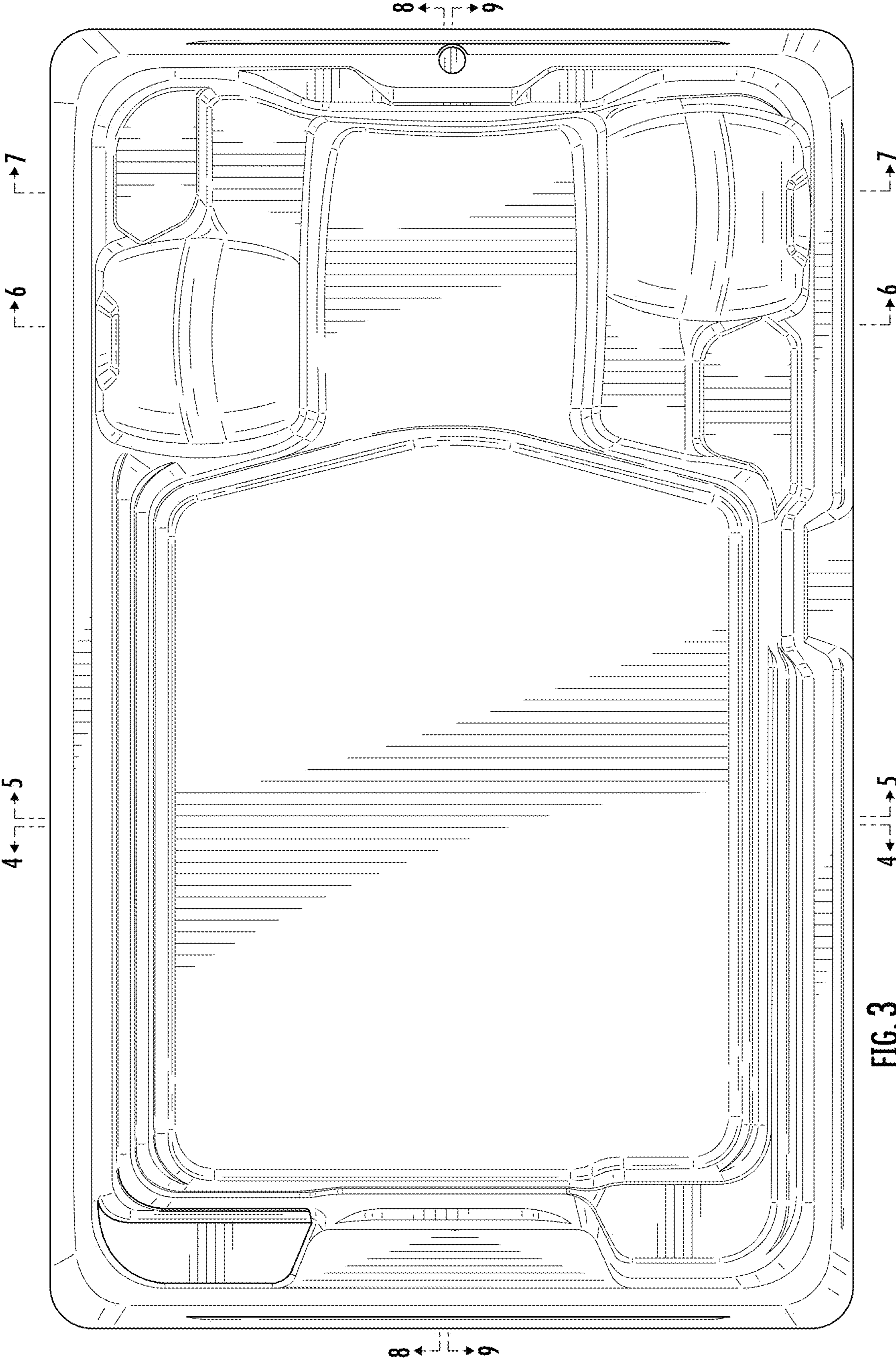

FIG. 3

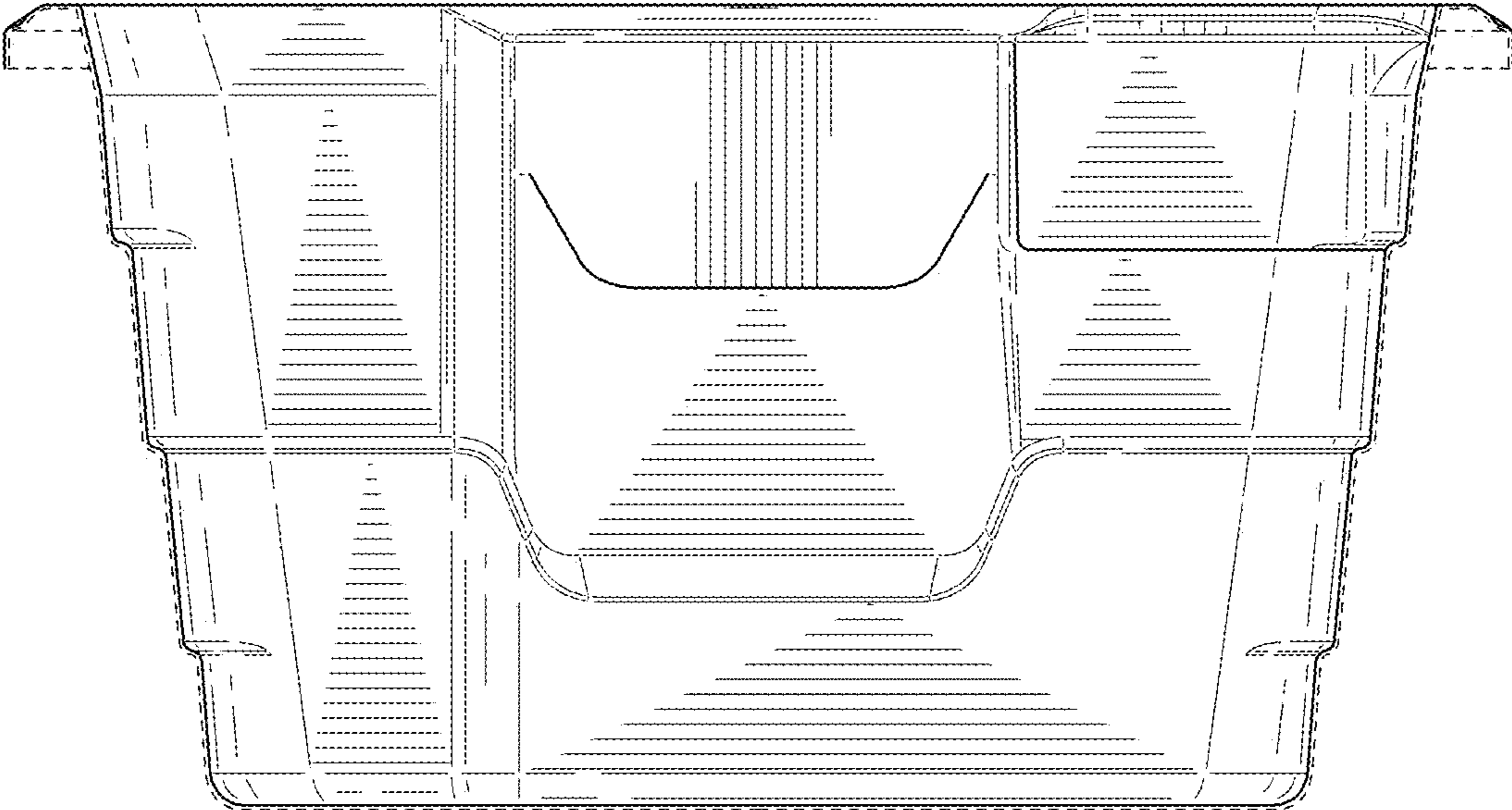

FIG. 4

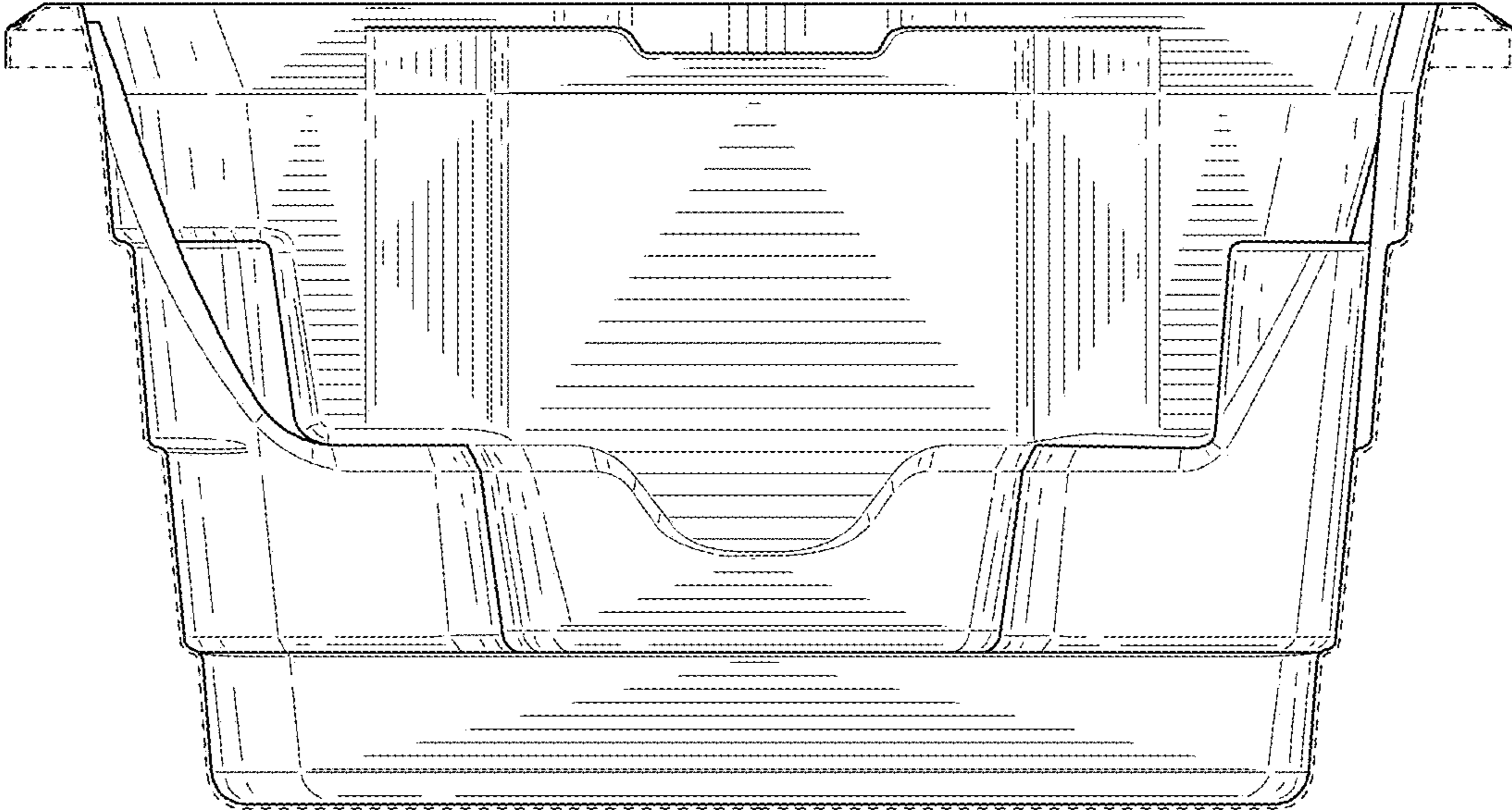

FIG. 5

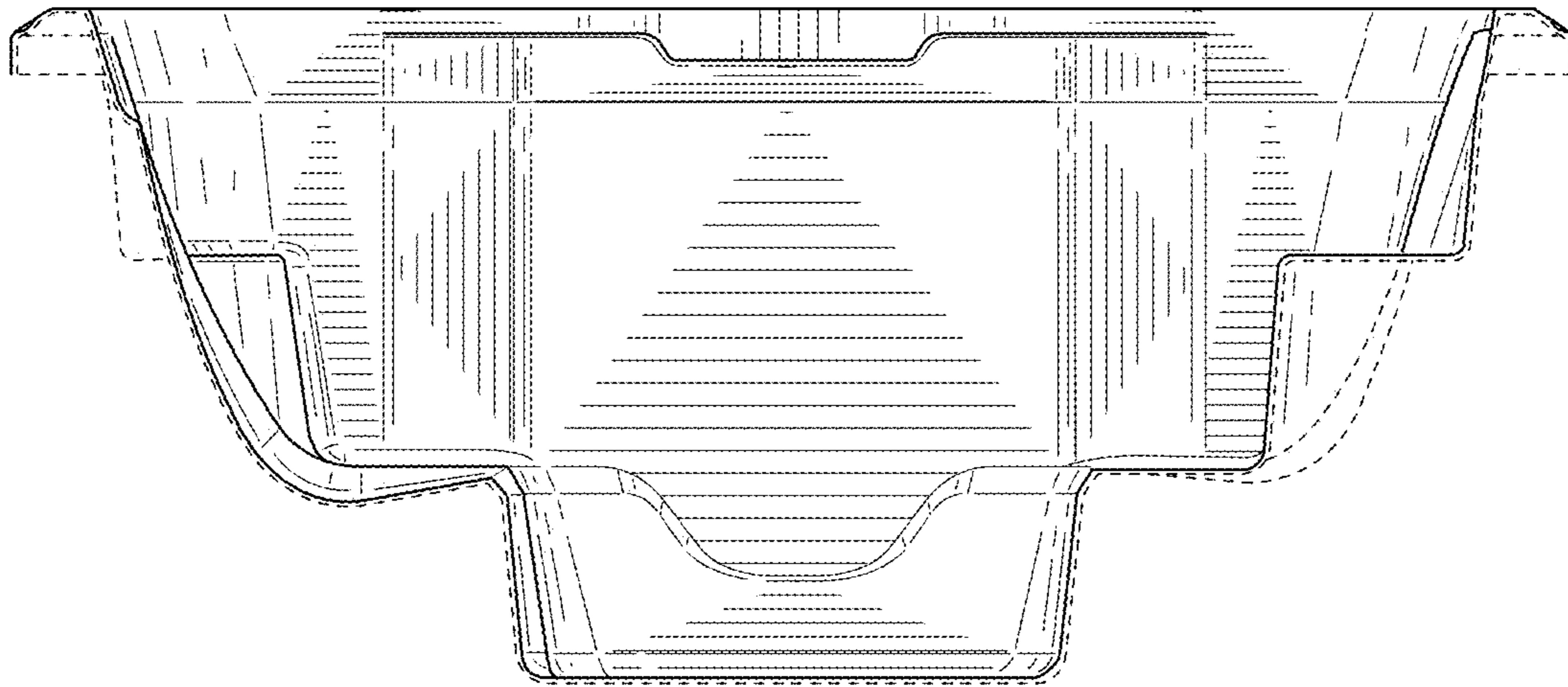

FIG. 6

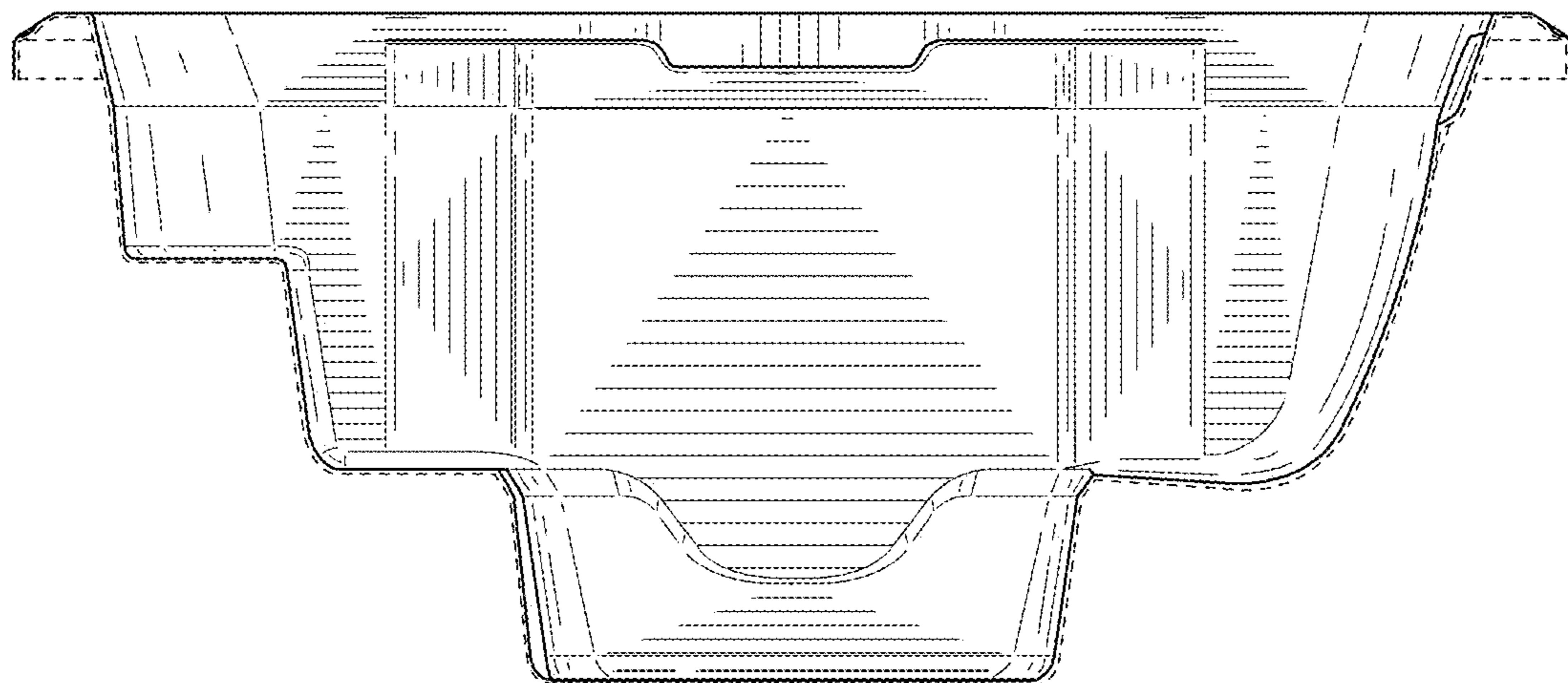

FIG. 7

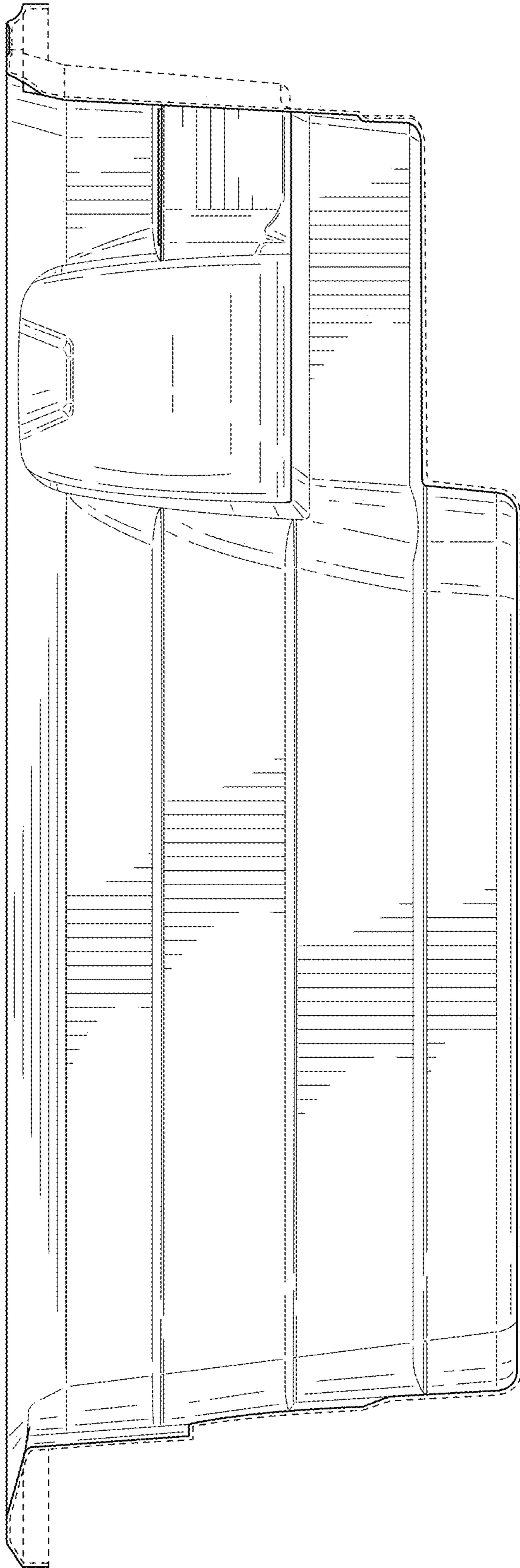

FIG. 8

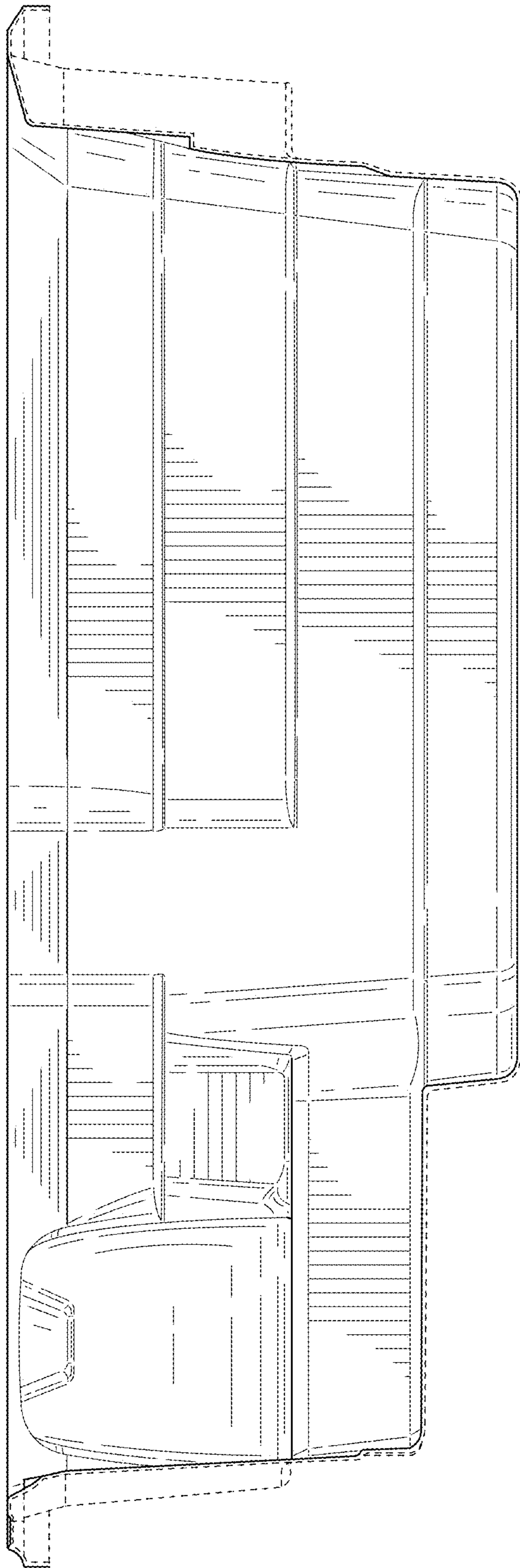

FIG. 9