

US00D924374S

(12) **United States Design Patent** (10) **Patent No.:** **US D924,374 S**
Pohl et al. (45) **Date of Patent:** **** Jul. 6, 2021**

(54) **COVER FOR LINEAR SHOWER DRAIN**

(71) Applicant: **ARTEFAKT design pohl/fiegl gbl**,
Darmstadt (DE)

(72) Inventors: **Achim Pohl**, Darmstadt (DE); **Thomas Fiegl**, Darmstadt (DE)

(73) Assignee: **ARTEFAKT INDUSTRIEKULTUR**,
Darmstadt (DE)

(**) Term: **15 Years**

(21) Appl. No.: **29/747,820**

(22) Filed: **Aug. 25, 2020**

(51) **LOC (13) Cl.** **23-01**

(52) **U.S. Cl.**
USPC **D23/261**
CPC **E03F 5/06** (2013.01)

(58) **Field of Classification Search**
USPC D23/259–262, 208–210, 267, 268,
D23/386–388, 397, 400, 406; 210/164;
4/222.1, 255.07, 286–293, 680–682, 694;
404/2–4, 42
CPC E03C 1/23; E03C 1/26; E03C 1/262; E03F
5/06; E03F 5/0407; E03F 5/052
See application file for complete search history.

(56) **References Cited**

U.S. PATENT DOCUMENTS

D421,101 S * 2/2000 Barnett D23/261
7,066,685 B2 * 6/2006 Humphries E03F 5/06
210/163
D532,877 S * 11/2006 Hisey D23/304
D563,528 S * 3/2008 Diamond D23/261
D575,881 S * 8/2008 Diamond D25/156
D587,346 S * 2/2009 Diamond D23/261
8,043,497 B2 * 10/2011 Silverstein E03F 5/0407
210/164
D663,387 S * 7/2012 Mjelde D23/261
8,239,974 B2 * 8/2012 Erlebach E03F 5/04
4/291
D687,524 S * 8/2013 Heiser D23/261

D687,525 S * 8/2013 Heiser D23/261
D694,863 S * 12/2013 Brodey D23/261
8,850,633 B2 * 10/2014 Erlebach E03F 5/04
4/679
D720,837 S * 1/2015 Bernoti D23/260
D721,424 S * 1/2015 Bernoti D23/260
D721,795 S * 1/2015 Bernoti D23/260
D722,139 S * 2/2015 Bernoti D23/260
D722,365 S * 2/2015 Bernoti D23/259
D723,139 S * 2/2015 Bernoti D23/260
D736,354 S * 8/2015 Lucas D23/261

(Continued)

Primary Examiner — Richard E Chilcot

(74) Attorney, Agent, or Firm — Paul & Paul

(57) **CLAIM**

An ornamental design for a cover for a linear shower drain,
as shown and described.

DESCRIPTION

FIG. 1 is a top plan view of a cover for a linear shower drain
according to the present invention.

FIG. 2 is a bottom plan view of the cover for a linear shower
drain of FIG. 1.

FIG. 3 is a front elevational view of the cover for a linear
shower drain of FIG. 1. The rear of the cover for a linear
shower drain has the same appearance like the front of the
cover for a linear shower drain.

FIG. 4 is a left side elevational view of the cover for a linear
shower drain of FIG. 1. The right side of the cover for a
linear shower drain has the same appearance like the left side
of the cover for a linear shower drain.

FIG. 5 is a perspective view of the cover for a linear shower
drain of FIG. 1.

FIG. 6 is a perspective view of the cover for a linear shower
drain of FIG. 1 showing a partial cross-section of the cover;
and,

FIG. 7 is an exploded perspective view of the cover for a
linear shower drain of FIG. 1.

1 Claim, 7 Drawing Sheets

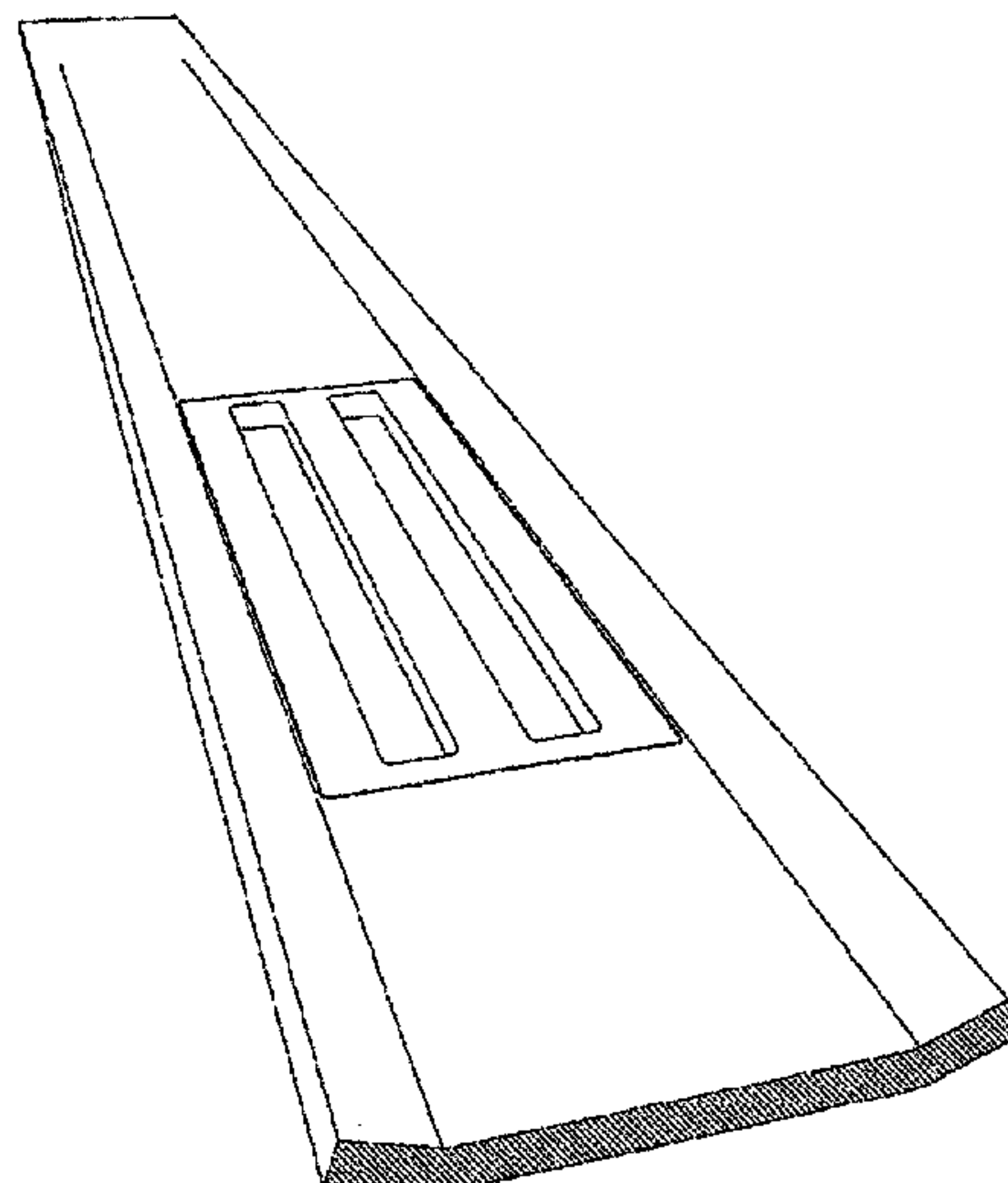

(56)

References Cited

U.S. PATENT DOCUMENTS

D736,355	S *	8/2015	Lucas	D23/261
D763,432	S *	8/2016	Carroll	D23/388
D776,246	S *	1/2017	Licini	D23/261
D779,051	S *	2/2017	Carroll	D23/388
9,611,634	B2 *	4/2017	Erlebach	E03F 5/0408
D843,550	S *	3/2019	Oatey	D23/261
D865,424	S *	11/2019	Kinoshita	D6/716.7
2008/0017562	A1 *	1/2008	Tripodi	E03F 5/14
					210/163
2008/0104910	A1 *	5/2008	Andras	E03F 5/0407
					52/302.3
2008/0271232	A1 *	11/2008	Self	E03C 1/264
					4/292
2014/0223659	A1 *	8/2014	Gay	E03C 1/244
					4/694

* cited by examiner



Fig. 1



Fig. 2

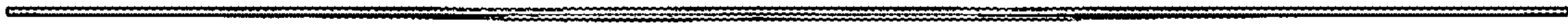

Fig. 3

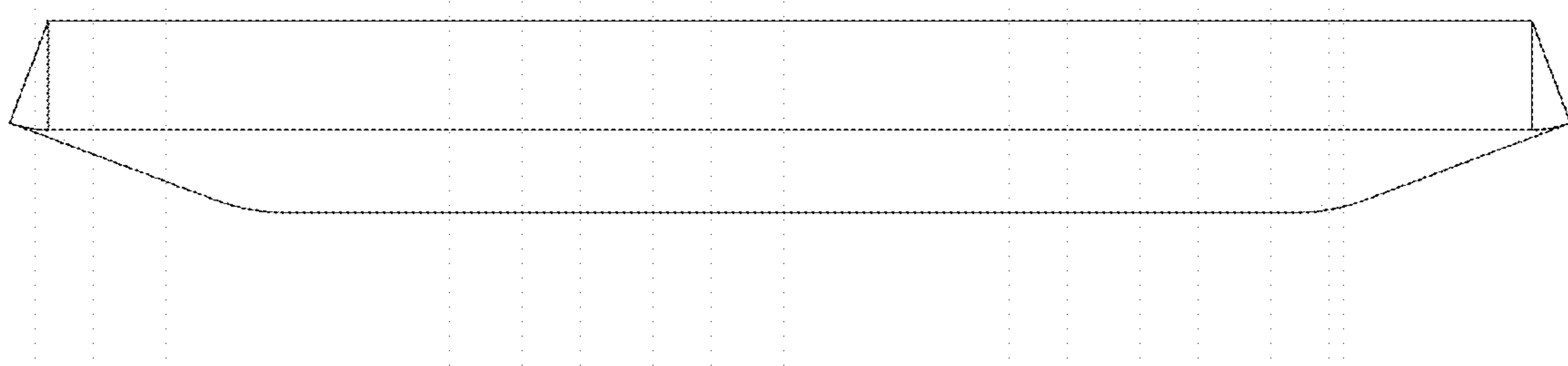

Fig. 4

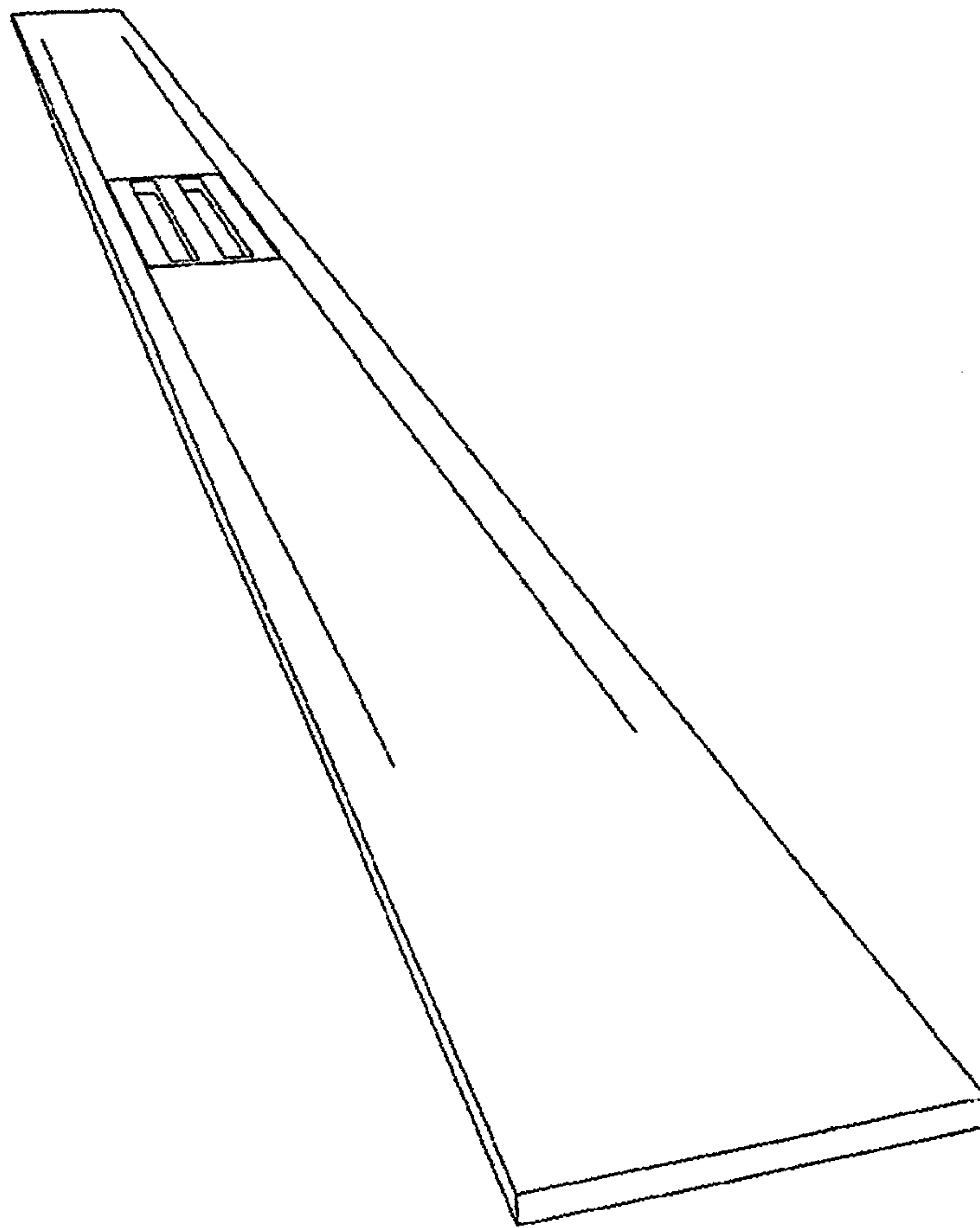

Fig. 5

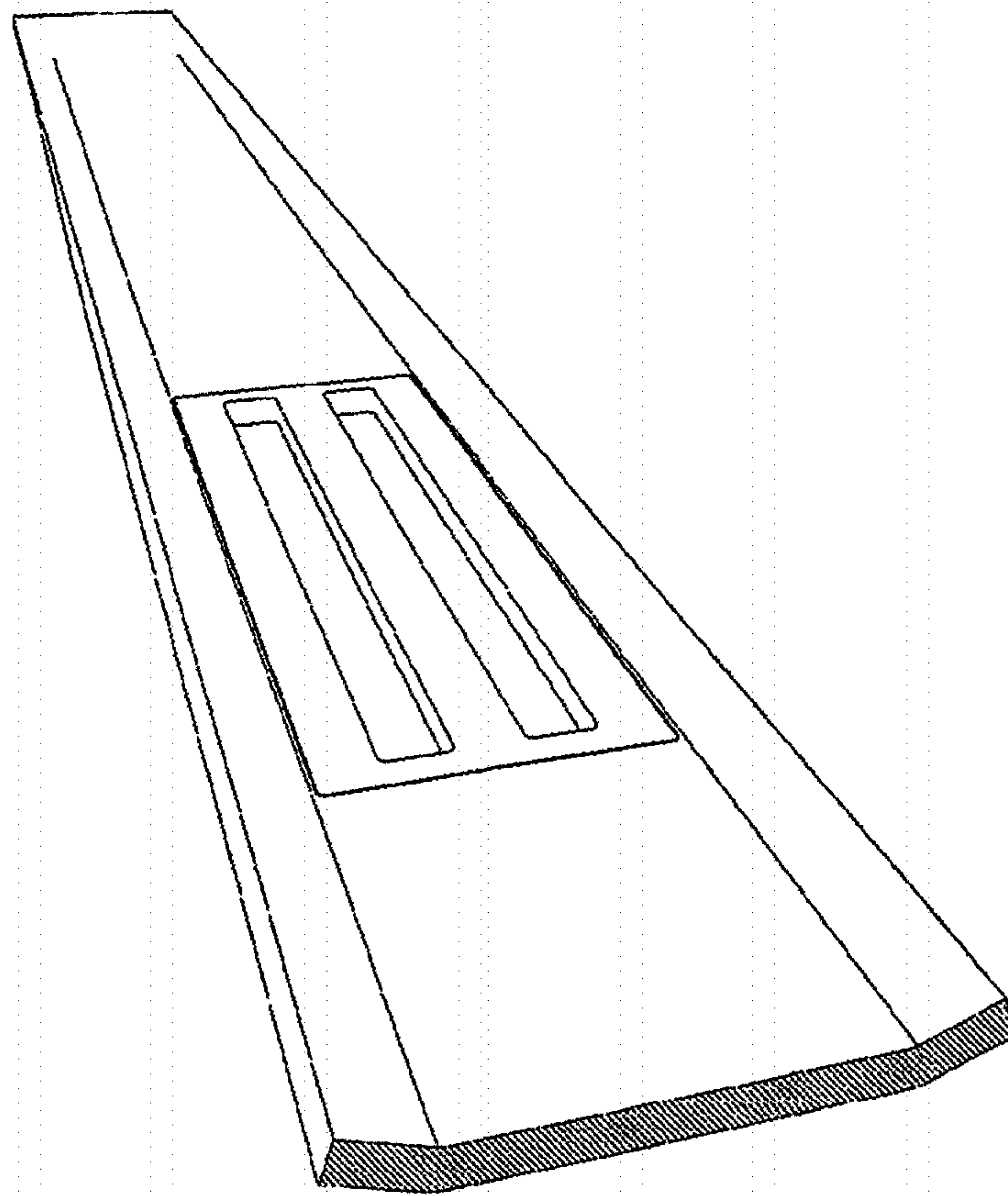

Fig. 6

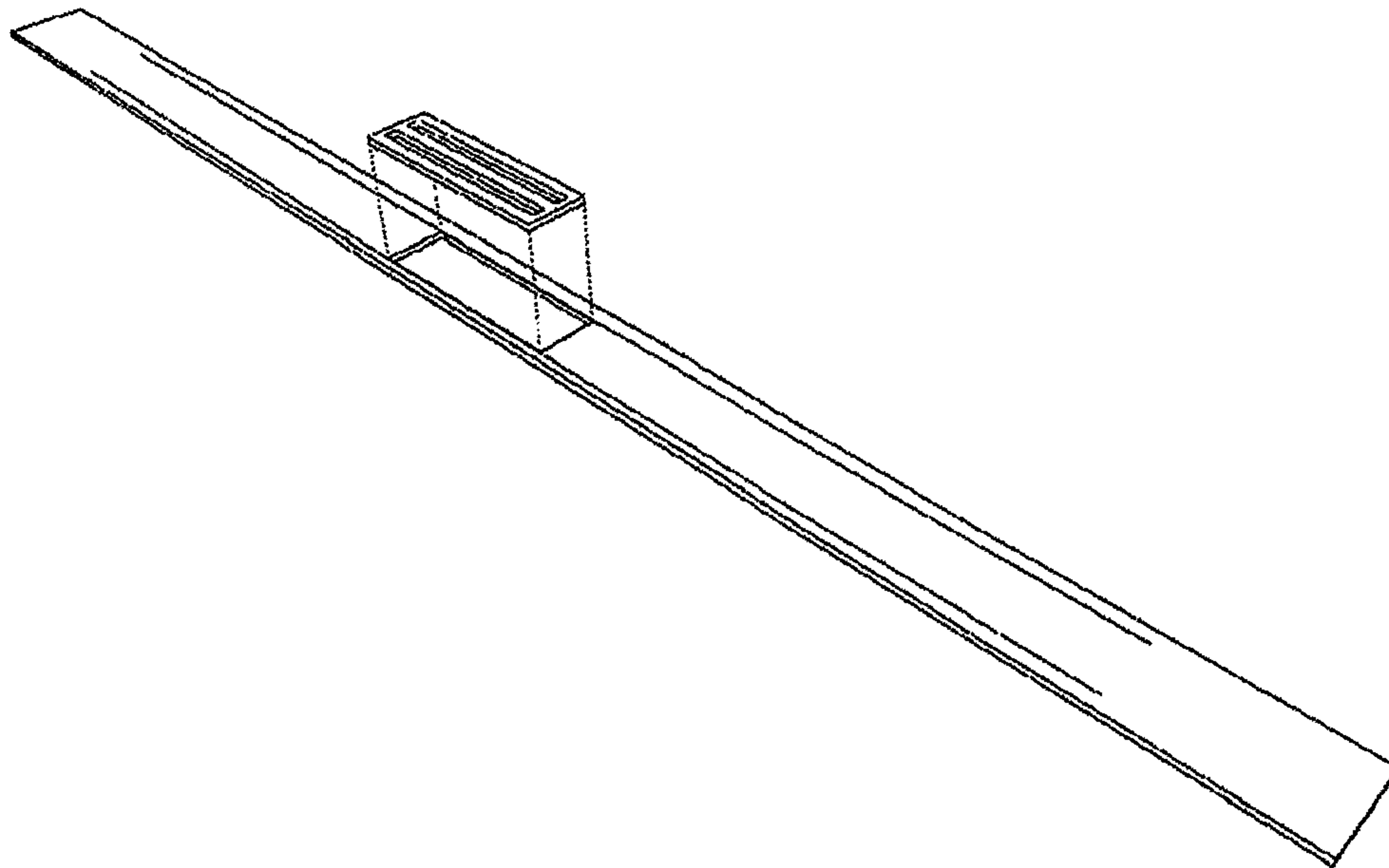

Fig. 7

UNITED STATES PATENT AND TRADEMARK OFFICE
CERTIFICATE OF CORRECTION

PATENT NO. : D924,374 S
APPLICATION NO. : 29/747820
DATED : July 6, 2021
INVENTOR(S) : Pohl et al.

Page 1 of 1

It is certified that error appears in the above-identified patent and that said Letters Patent is hereby corrected as shown below:

On the Title Page

Insert the following paragraph after item “(22) Filed: Aug. 25, 2020”:

-- Related U.S. Application Data

(62) Division of application No. 35/507,390, filed on Mar. 8, 2019 (U.S. filing date under 35 U.S.C. 384), and having an international filing date of Mar. 8, 2019, now Pat. No. Des. 909,544. --

Signed and Sealed this
Twenty-first Day of September, 2021



Drew Hirshfeld
*Performing the Functions and Duties of the
Under Secretary of Commerce for Intellectual Property and
Director of the United States Patent and Trademark Office*