



US00D924345S

(12) **United States Design Patent** (10) **Patent No.:** **US D924,345 S**
Nicolette et al. (45) **Date of Patent:** **** Jul. 6, 2021**

(54) **GOLF CLUB HEAD**

(71) Applicant: **PARSONS XTREME GOLF, LLC**,
Scottsdale, AZ (US)

(72) Inventors: **Michael R. Nicolette**, Scottsdale, AZ
(US); **Bradley D. Schweigert**, Cave
Creek, AZ (US)

(73) Assignee: **PARSONS XTREME GOLF, LLC**,
Scottsdale, AZ (US)

(**) Term: **15 Years**

(21) Appl. No.: **29/707,870**

(22) Filed: **Oct. 1, 2019**

Related U.S. Application Data

(63) Continuation-in-part of application No. 29/687,740,
filed on Apr. 15, 2019, now abandoned.

(51) **LOC (13) Cl.** **21-02**

(52) **U.S. Cl.**
USPC **D21/736**

(58) **Field of Classification Search**
USPC D21/736-746, 759

(Continued)

(56) **References Cited**

U.S. PATENT DOCUMENTS

723,534 A 3/1903 Knight
922,444 A 5/1909 Youds

(Continued)

FOREIGN PATENT DOCUMENTS

JP 2004223184 A 8/2004
JP 2005160691 6/2005

(Continued)

OTHER PUBLICATIONS

U.S. Appl. No. 29/523,587, Schweigert, "Golf Club Head," filed
Apr. 10, 2015.

(Continued)

Primary Examiner — Mitchell I. Siegel

(57) **CLAIM**

The ornamental design for a golf club head, as shown and
described.

DESCRIPTION

FIG. 1 is a top perspective view of a golf club head;
FIG. 2 is a bottom perspective view of the golf club head of
FIG. 1;
FIG. 3 is a front elevational view of the golf club head of
FIG. 1;
FIG. 4 is a rear elevational view of the golf club head of FIG.
1;
FIG. 5 is a top view of the golf club head of FIG. 1;
FIG. 6 is a bottom view of the golf club head of FIG. 1;
FIG. 7 is a left side view of the golf club head of FIG. 1;
FIG. 8 is a right side view of the golf club head of FIG. 1;
FIG. 9 is a top perspective view of a second embodiment of
a golf club head;
FIG. 10 is a bottom perspective view of the golf club head
of FIG. 9;
FIG. 11 is a front elevational view of the golf club head of
FIG. 9;
FIG. 12 is a rear elevational view of the golf club head of
FIG. 9;
FIG. 13 is a top view of the golf club head of FIG. 9;
FIG. 14 is a bottom view of the golf club head of FIG. 9;
FIG. 15 is a left side view of the golf club head of FIG. 9;
and,
FIG. 16 is a right side view of the golf club head of FIG. 9.
The broken lines shown on the drawing figures form no part
of the claimed design.

1 Claim, 14 Drawing Sheets

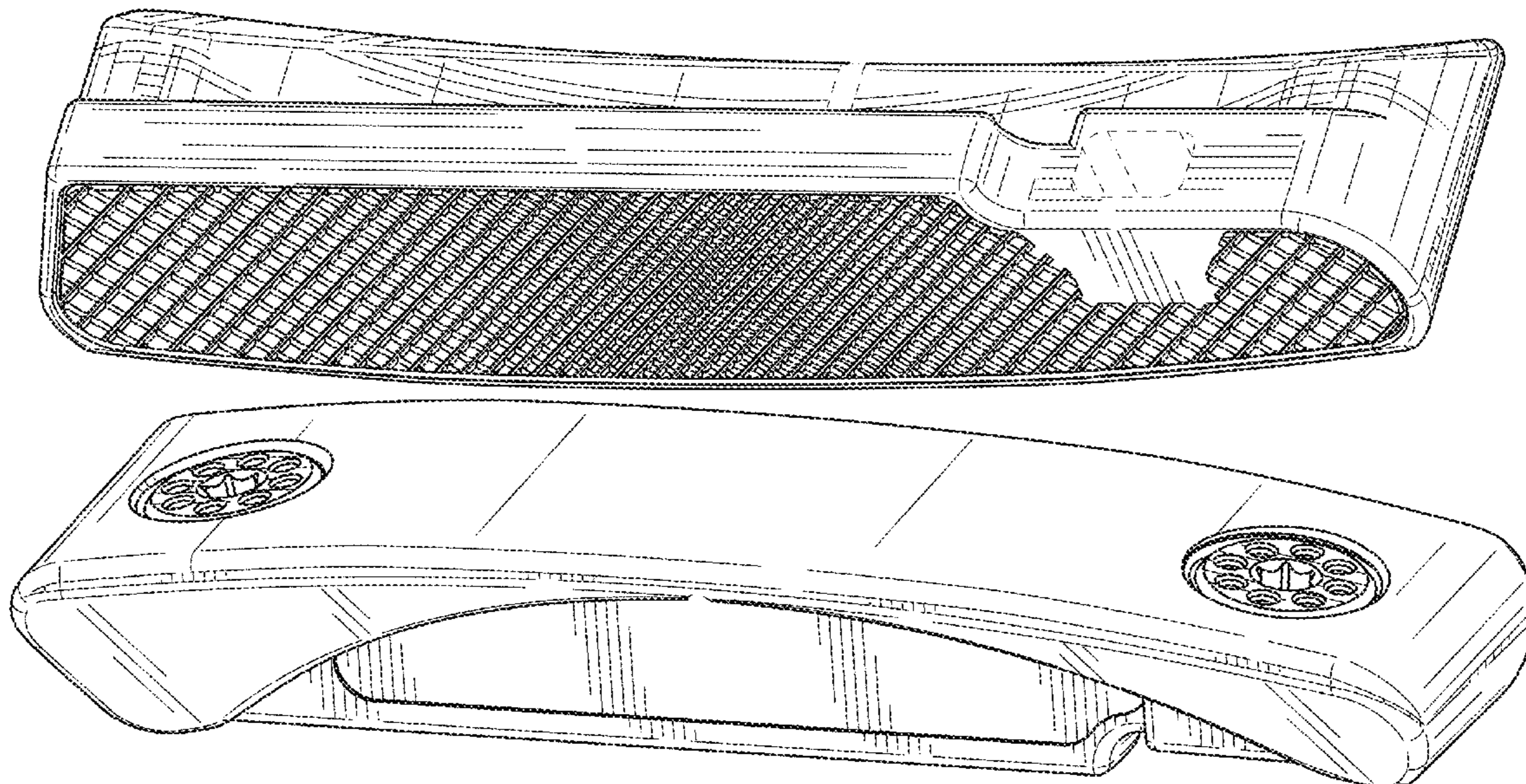

(58) **Field of Classification Search**
 CPC A63B 53/00; A63B 53/04; A63B 53/007;
 A63B 53/065; A63B 53/0487; A63B
 60/00; A63B 60/46
 See application file for complete search history.

(56) **References Cited**

U.S. PATENT DOCUMENTS

RE19,178 E 5/1934 Spiker
 D213,509 S * 3/1969 Solheim D21/743
 D231,375 S * 4/1974 Solheim D21/742
 D235,465 S * 6/1975 Vella D21/736
 4,043,562 A 8/1977 Shillington
 4,340,230 A 7/1982 Churchward
 4,754,977 A 7/1988 Sahm
 4,869,507 A 9/1989 Sahm
 D306,630 S * 3/1990 Dinte D21/743
 4,964,641 A 10/1990 Miesch
 D335,317 S 5/1993 Shearer
 D335,692 S 5/1993 Antonious
 D336,757 S 6/1993 Antonious
 5,275,412 A 1/1994 Innes
 D350,582 S 9/1994 Miansian et al.
 D356,132 S * 3/1995 Ackerman D21/743
 5,429,366 A 7/1995 McCabe
 D363,101 S 10/1995 Sturm
 5,489,097 A 2/1996 Simmons
 D368,751 S 4/1996 Rife
 D369,393 S 4/1996 Yutaka
 D365,864 S 10/1996 Strum
 5,571,053 A 11/1996 Lane
 D378,688 S 4/1997 Cameron, Jr.
 D385,609 S 10/1997 Cameron
 5,683,307 A 11/1997 Rife
 D388,143 S 12/1997 Huan-Chiang
 D389,207 S 1/1998 Cameron
 D396,685 S 9/1998 Masuda
 D399,290 S 10/1998 Sizemore, Jr.
 D399,911 S 10/1998 Sanchez
 5,839,974 A 11/1998 McAllister
 D405,836 S 2/1999 Nicolette et al.
 D408,064 S * 4/1999 Slacker D21/736
 D409,701 S 5/1999 Ashcraft et al.
 5,924,938 A 7/1999 Hines
 6,007,434 A 12/1999 Baker
 D422,655 S 4/2000 Hicks
 6,050,903 A 4/2000 Lake
 D426,276 S 6/2000 Besnard et al.
 D427,262 S * 6/2000 Frazetta D21/743
 D431,854 S 10/2000 Cameron
 D432,192 S 10/2000 Hicks
 D436,151 S 1/2001 Nicolette et al.
 D437,374 S 2/2001 Cameron
 D441,820 S 5/2001 Nicolette et al.
 D443,668 S 6/2001 Nicolette et al.
 D443,905 S * 6/2001 Nicolette D21/743
 D444,833 S 7/2001 Nicolette
 6,257,994 B1 7/2001 Antonious
 6,264,571 B1 7/2001 Lekavich
 D449,664 S 10/2001 Beebe et al.
 D449,865 S 10/2001 Fife, Jr. et al.
 D450,799 S 11/2001 Nicolette et al.
 D451,973 S 12/2001 Wells et al.
 6,348,014 B1 2/2002 Chiu
 6,354,959 B1 3/2002 Nicolette
 6,394,910 B1 5/2002 McCarthy
 D463,517 S * 9/2002 Ngon D21/736
 D472,949 S * 4/2003 Serrano D21/736
 D474,821 S 5/2003 Wells et al.
 D474,949 S 5/2003 Schaffeld et al.
 6,652,390 B2 11/2003 Bradford
 D483,086 S 12/2003 Schweigert
 D486,194 S * 2/2004 Helmstetter D21/743
 D486,872 S 2/2004 Schweigert et al.
 D488,200 S 4/2004 Morgulis
 D498,276 S 11/2004 Schweigert et al.

6,902,496 B2 6/2005 Solheim
 D512,116 S 11/2005 Miraflor et al.
 6,988,955 B2 1/2006 Stoakes
 6,988,956 B2 1/2006 Cover
 D520,088 S 5/2006 Parr
 D531,242 S 10/2006 Adams
 7,125,341 B1 10/2006 D Eath
 D532,067 S 11/2006 Soracco
 7,153,220 B2 12/2006 Lo
 D534,595 S 1/2007 Hasebe
 7,156,752 B1 1/2007 Bennett
 D536,401 S 2/2007 Kawami
 D536,403 S 2/2007 Kawami
 D538,371 S 3/2007 Kawami
 7,204,765 B2 4/2007 Cover
 D542,869 S 5/2007 Adams
 D543,598 S 5/2007 Kuan et al.
 D543,601 S 5/2007 Kawami
 D555,219 S 11/2007 Lin
 D556,277 S 11/2007 Broom
 7,309,297 B1 12/2007 Solari
 D561,854 S 2/2008 Morris
 7,331,876 B2 2/2008 Klein
 7,351,162 B2 4/2008 Soracco
 D569,461 S 5/2008 Morris
 D569,930 S 5/2008 Nehrbas
 7,396,289 B2 7/2008 Soracco
 D574,912 S * 8/2008 Jones D21/743
 D577,086 S 8/2008 Nicolette et al.
 D577,085 S 9/2008 Nicolette et al.
 D579,506 S 10/2008 Nicolette et al.
 D579,995 S 11/2008 Nicolette et al.
 D582,497 S 12/2008 Rollinson
 7,473,189 B2 1/2009 Schweigert
 7,491,131 B2 2/2009 Vinton
 D592,719 S * 5/2009 Hettinger D21/743
 D595,793 S 7/2009 Rollinson
 D596,683 S * 7/2009 Hettinger D21/746
 D599,425 S 9/2009 Laub
 D600,763 S 9/2009 Cameron
 7,744,485 B2 6/2010 Jones
 D620,993 S 8/2010 Laub
 D621,461 S 8/2010 Serrano
 D623,709 S 9/2010 Serrano et al.
 D631,925 S 2/2011 Broom
 7,887,432 B2 2/2011 Jones
 7,909,707 B2 3/2011 Klein
 7,918,745 B2 4/2011 Morris
 D636,891 S 5/2011 Nicolette et al.
 7,942,758 B2 5/2011 Nakamura
 D642,643 S 8/2011 Nicolette et al.
 D643,485 S 8/2011 Nicolette et al.
 D645,104 S 9/2011 Nicolette et al.
 8,096,039 B2 1/2012 Soracco
 D653,718 S 2/2012 Stokke et al.
 D661,753 S 6/2012 Cameron et al.
 D666,260 S 8/2012 Cynn
 D667,906 S * 9/2012 Butler D21/743
 8,371,958 B2 2/2013 Treadwell
 8,376,878 B2 2/2013 Bennett
 D688,339 S 8/2013 Hilton et al.
 D688,341 S 8/2013 Rollinson
 D691,226 S 10/2013 Hilton et al.
 D699,308 S 2/2014 Rollinson
 8,696,492 B1 4/2014 Hocknell
 D704,782 S 5/2014 Rollinson
 8,721,472 B2 5/2014 Kuan
 8,790,193 B2 7/2014 Serrano
 D711,483 S 8/2014 Wong
 D715,388 S 10/2014 Serrano
 D722,350 S 2/2015 Schweigert
 D722,351 S 2/2015 Parsons et al.
 D722,352 S 2/2015 Nicolette et al.
 D723,120 S 2/2015 Nicolette
 D724,164 S 3/2015 Schweigert et al.
 D725,208 S 3/2015 Schweigert
 D726,265 S 4/2015 Nicolette
 D726,846 S 4/2015 Schweigert
 D730,462 S 5/2015 Becktor

(56)

References Cited

U.S. PATENT DOCUMENTS

D732,122	S	6/2015	Becktor	
D732,618	S	6/2015	Nivanh	
D733,234	S	6/2015	Nicolette	
D738,447	S	9/2015	Schweigert	
D738,449	S	9/2015	Schweigert	
D739,487	S	9/2015	Schweigert	
D741,426	S	10/2015	Schweigert	
D748,213	S	1/2016	Parsons et al.	
D748,215	S	1/2016	Parsons et al.	
D753,252	S	4/2016	Schweigert	
D802,067	S *	11/2017	Solheim	D21/736
D857,819	S *	8/2019	Wang	D21/743
D896,329	S *	9/2020	Rollinson	D21/743
2004/0138003	A1	7/2004	Grace	
2004/0180730	A1	9/2004	Franklin	
2006/0052178	A1	3/2006	Franklin	
2006/0094522	A1	5/2006	Tang	
2006/0223649	A1	10/2006	Rife	
2007/0129163	A1	6/2007	Solari	
2007/0135229	A1	6/2007	Lo	
2007/0142122	A1	6/2007	Bonneau	
2007/0207875	A1	9/2007	Kuan	
2007/0238548	A1	10/2007	Johnson	
2008/0139333	A1	6/2008	Klein	
2008/0146372	A1	6/2008	John	
2008/0176672	A1	7/2008	Roach	
2009/0029800	A1	1/2009	Jones	

2010/0255922	A1	10/2010	Lueders
2011/0165959	A1	7/2011	Klein
2013/0165256	A1	6/2013	Stevenson
2013/0210537	A1	8/2013	Ainscough
2015/0057100	A1	2/2015	Serrano
2015/0258390	A1	9/2015	Defrancesco, Jr.
2015/0306477	A1	10/2015	Parsons
2016/0016050	A1	1/2016	Rife
2018/0001163	A1	1/2018	Becktor

FOREIGN PATENT DOCUMENTS

KR	200377377	Y1	3/2005
KR	200403045	Y1	12/2005
KR	20100065481	A	6/2010
KR	101773069	B1	5/2016

OTHER PUBLICATIONS

TourSpecGolf (Gold's Factory Multi Weighted Custom Putter) [online]. Nov. 20, 2010 [retrieved Apr. 26, 2016] Retrieved from the internet: <URL: <http://www.tourspecgolf.com/blog/golds-factory-multi-weighted-custom-putter/>>.

Plugged In Golf (2015 Bettinardi Putters Review) [online]. Mar. 3, 2015 [retrieved Nov. 25, 2019] Retrieve from the internet: <URL: <https://pluggedingolf.com/2015-bettinardi-putters-review/>>.

* cited by examiner

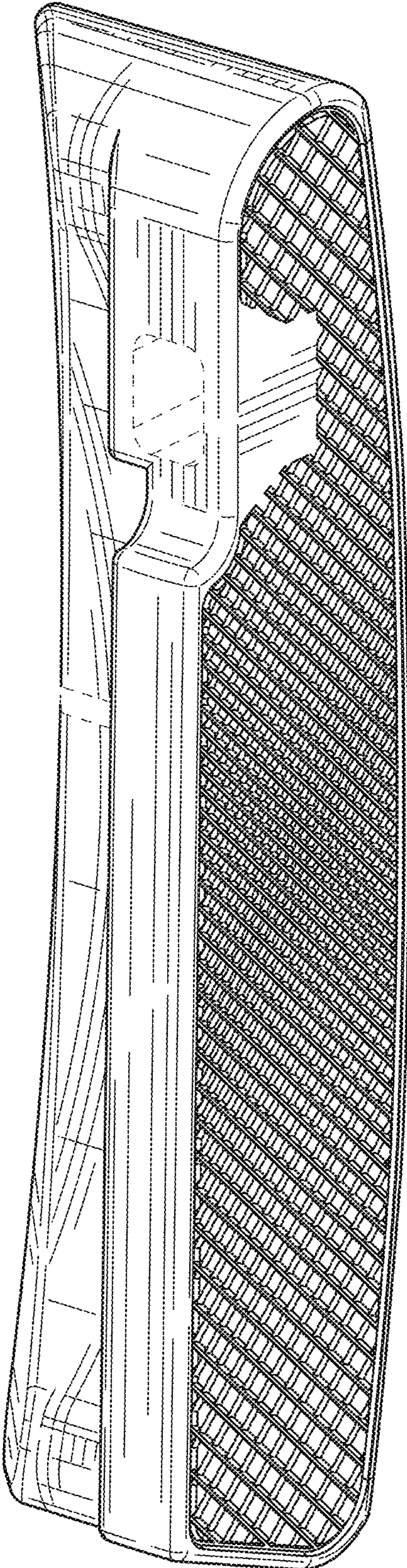

FIG. 1

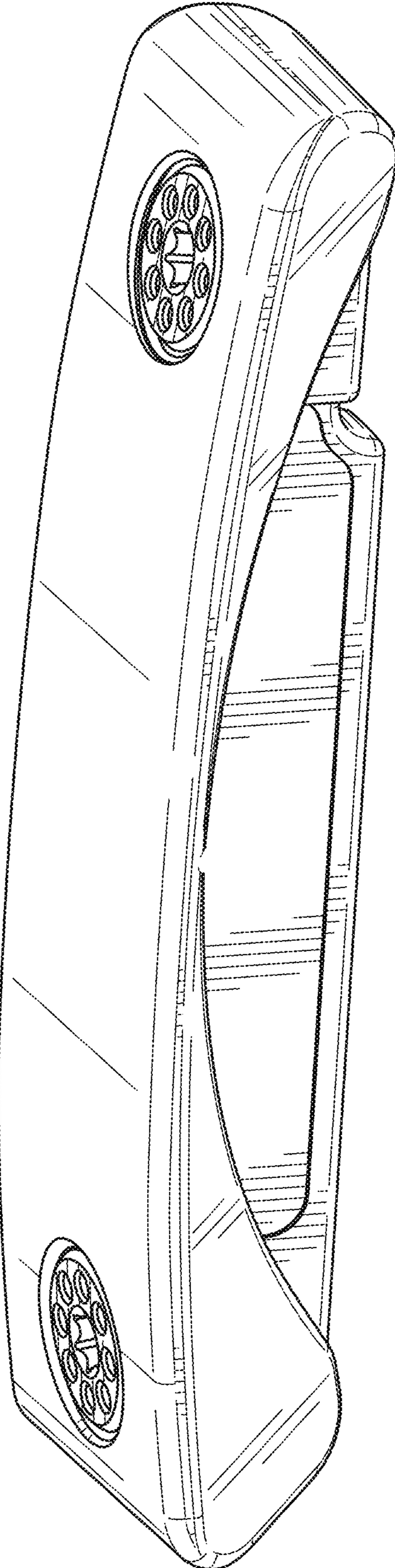

FIG. 2

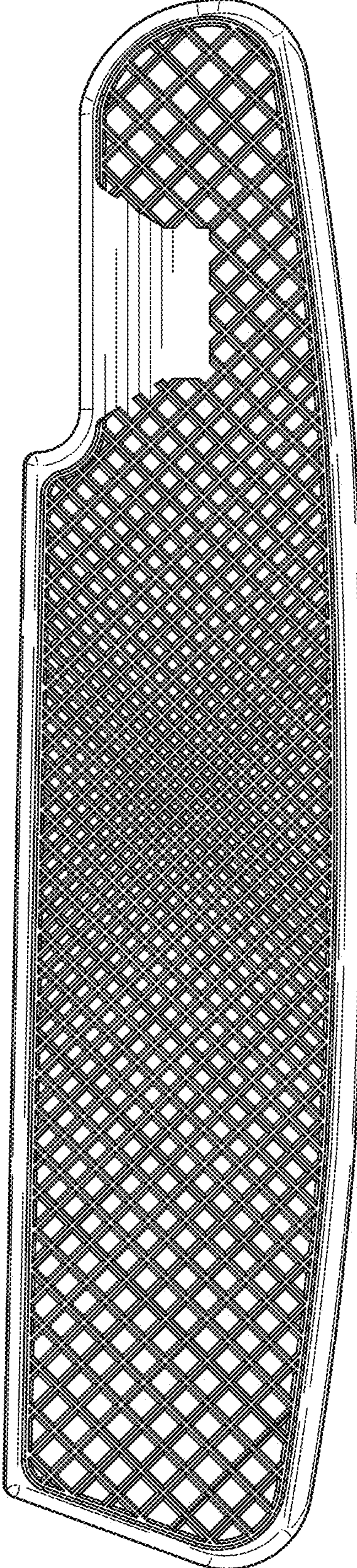

FIG. 3

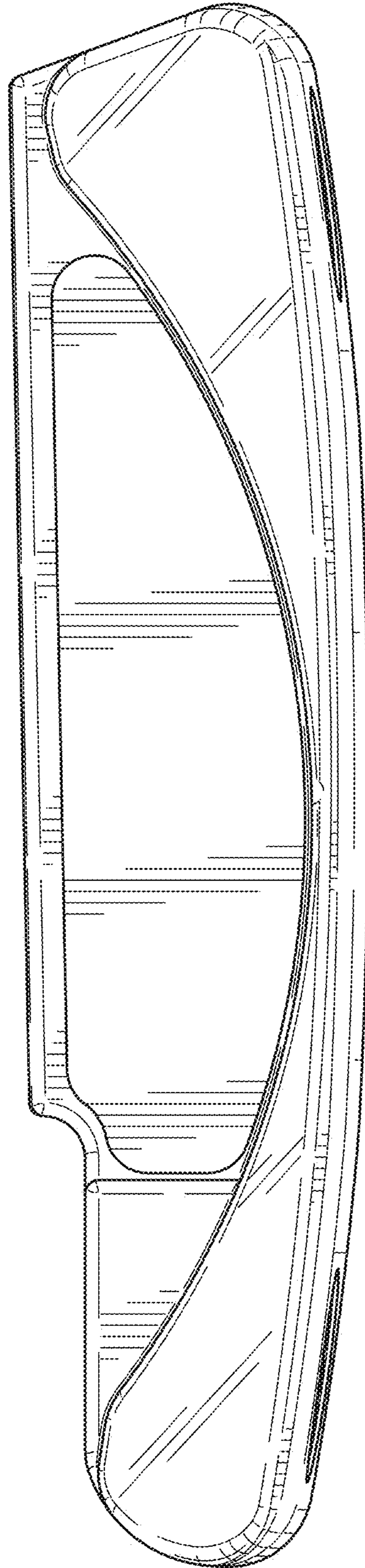

FIG. 4

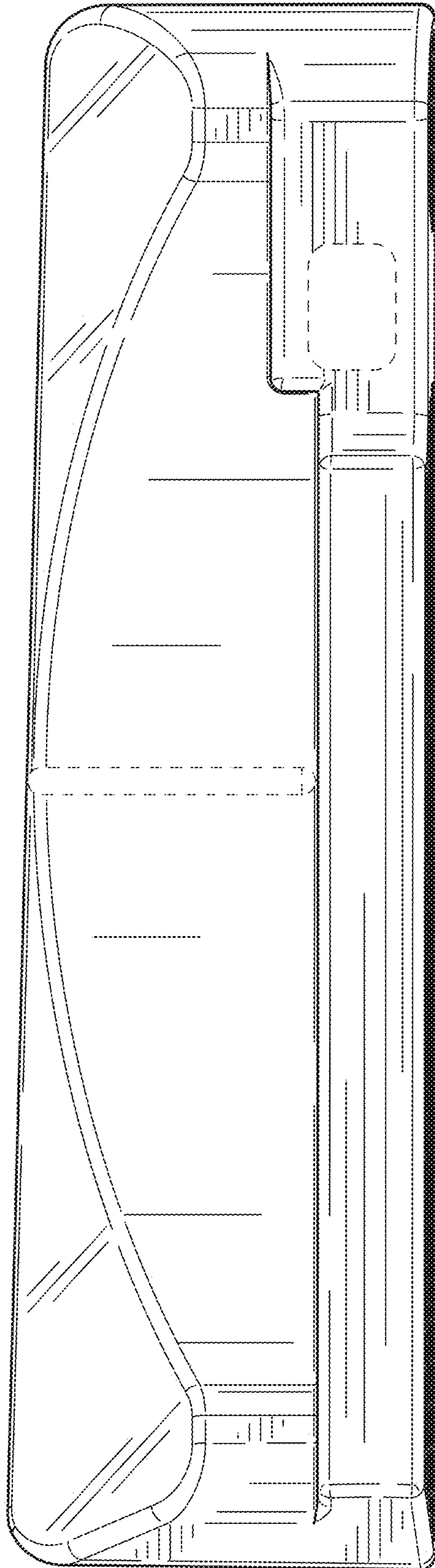

FIG. 5

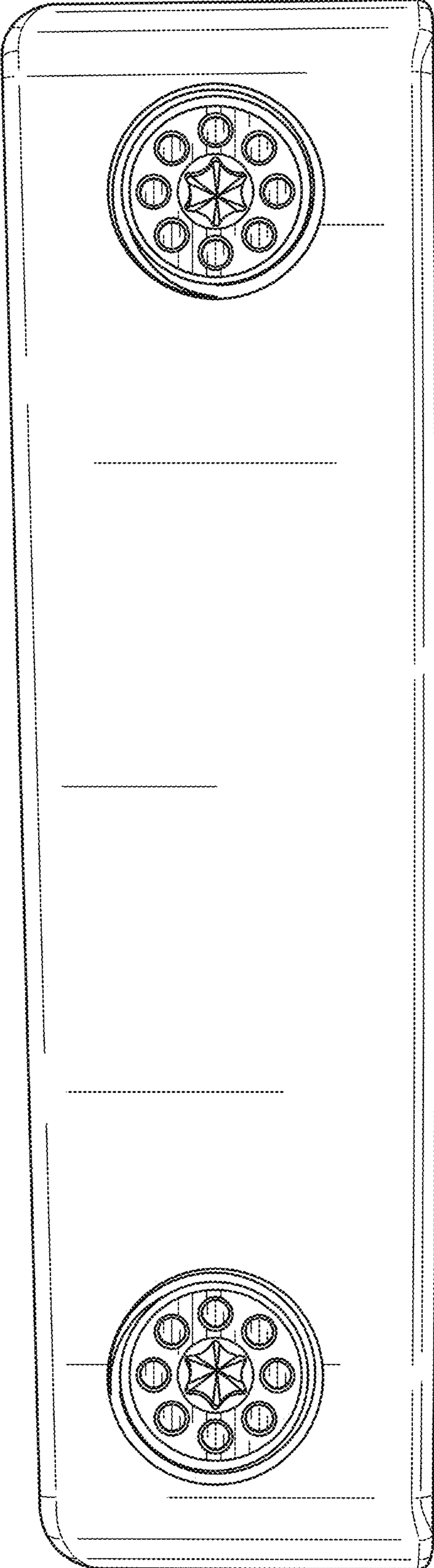

FIG. 6

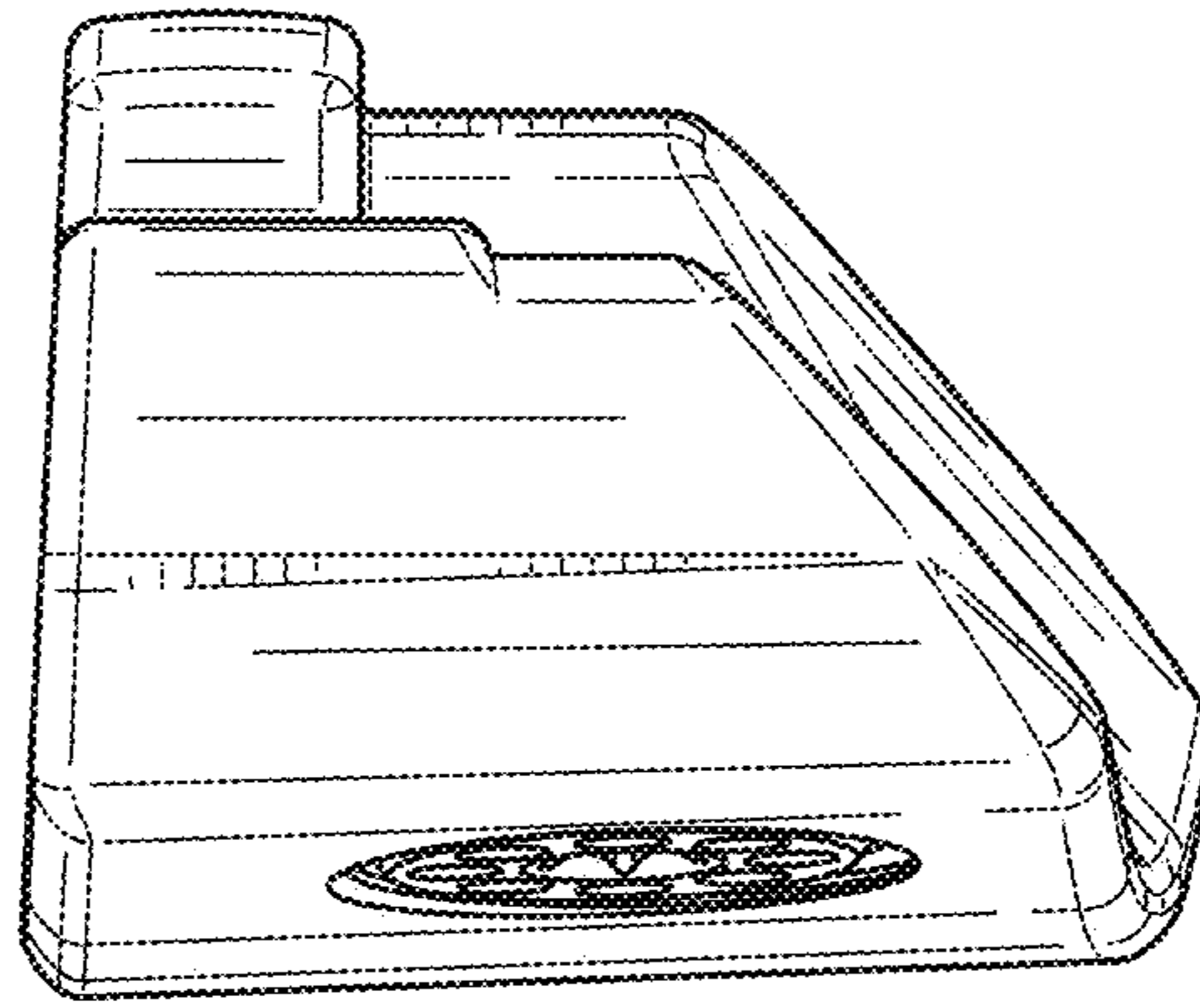

FIG. 7

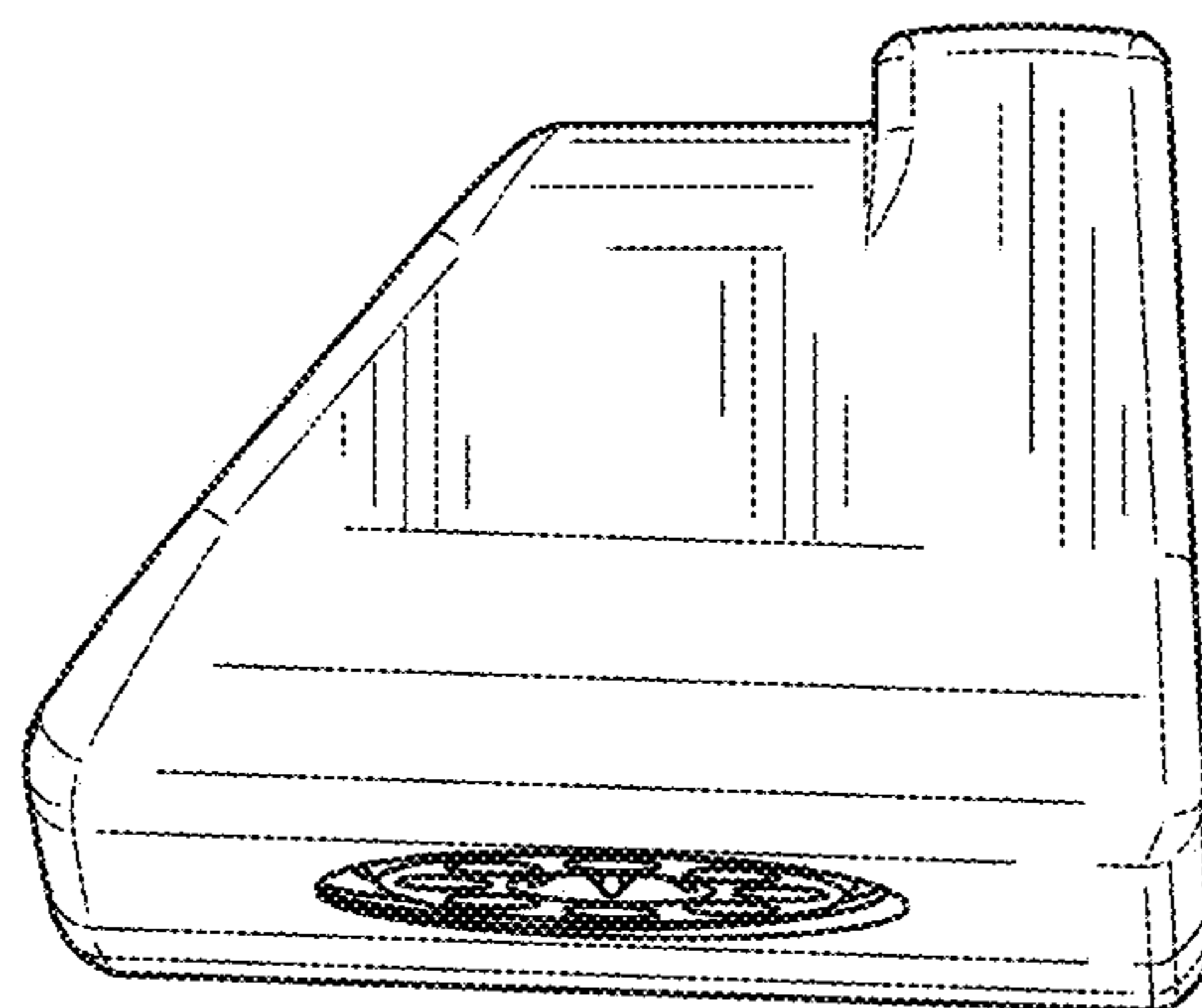

FIG. 8

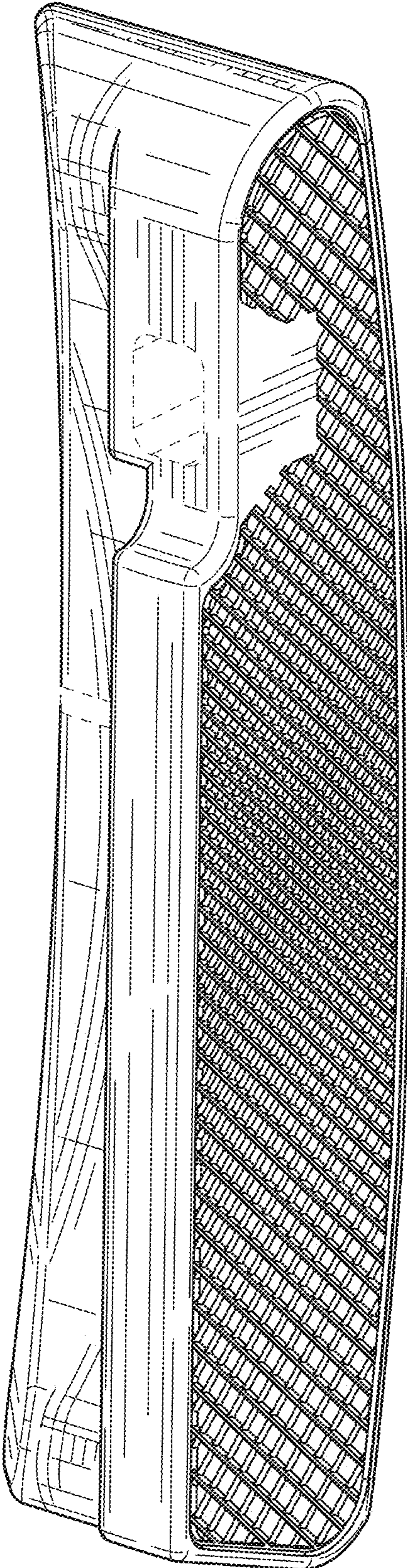

FIG. 9

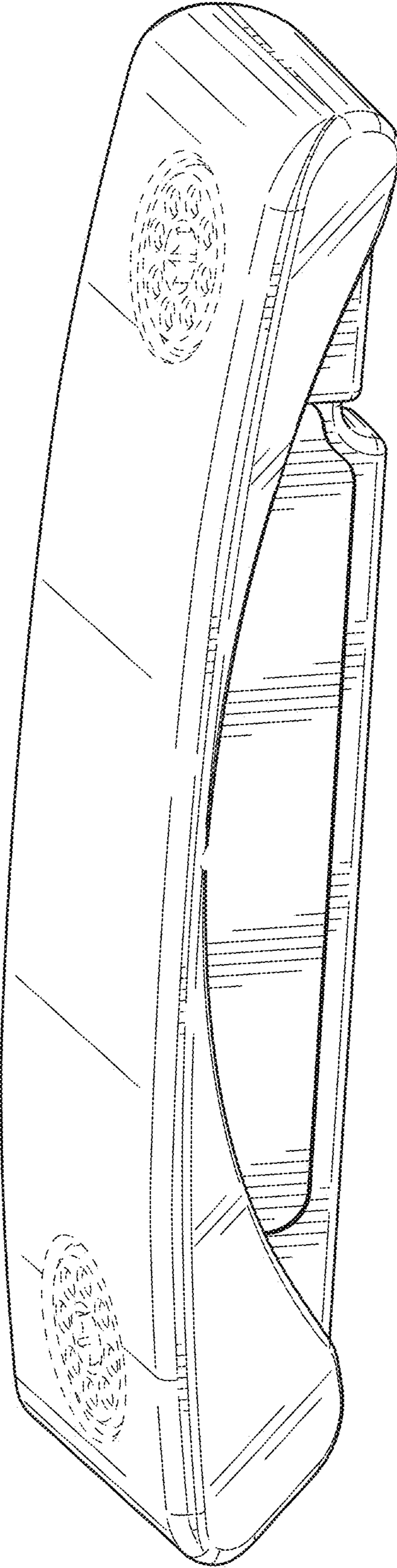

FIG. 10

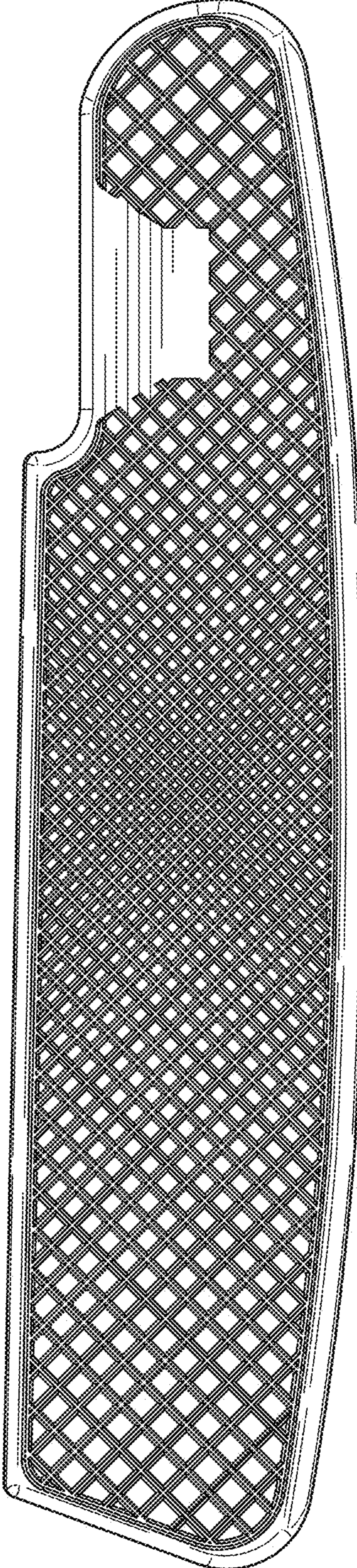

FIG. 11

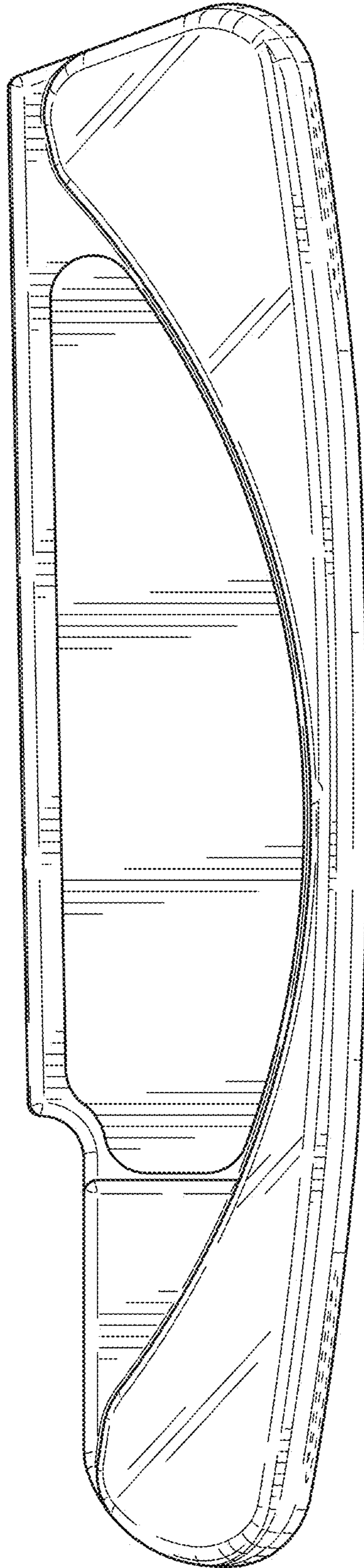

FIG. 12

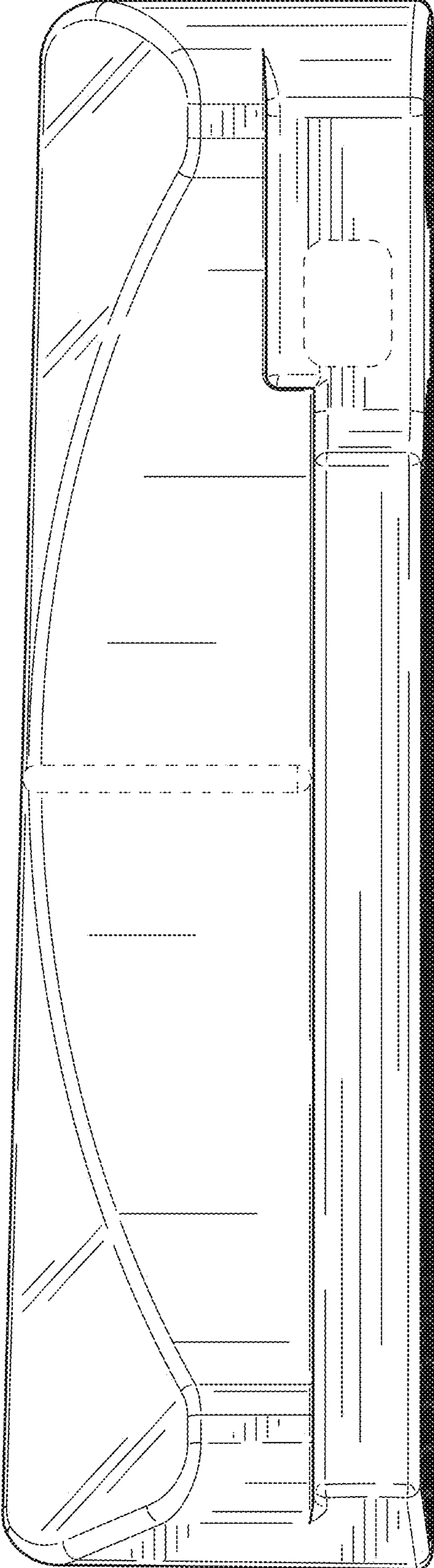

FIG. 13

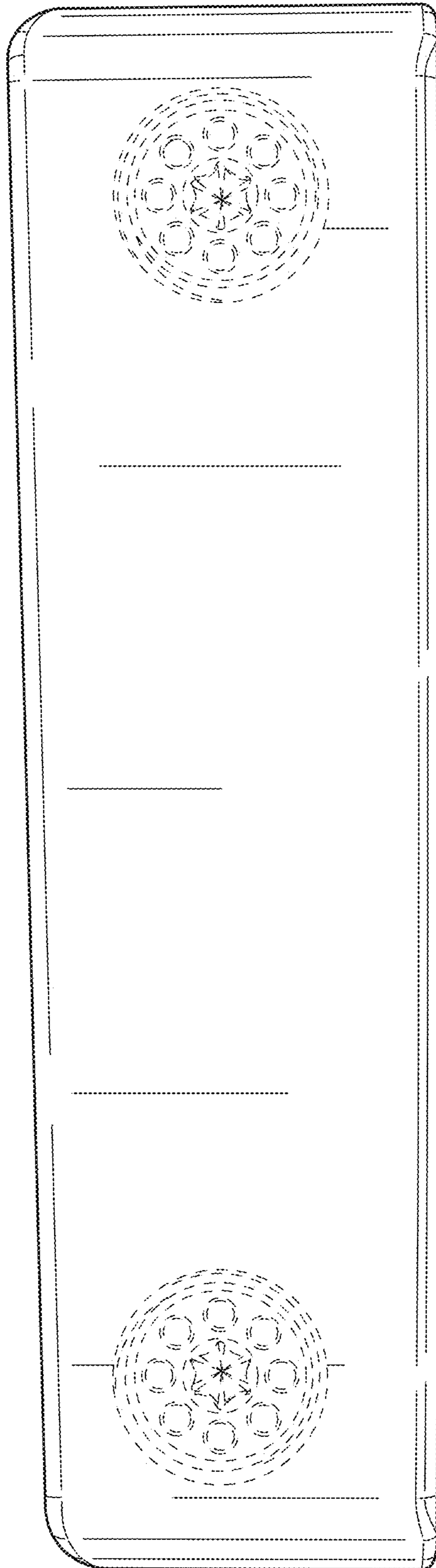

FIG. 14

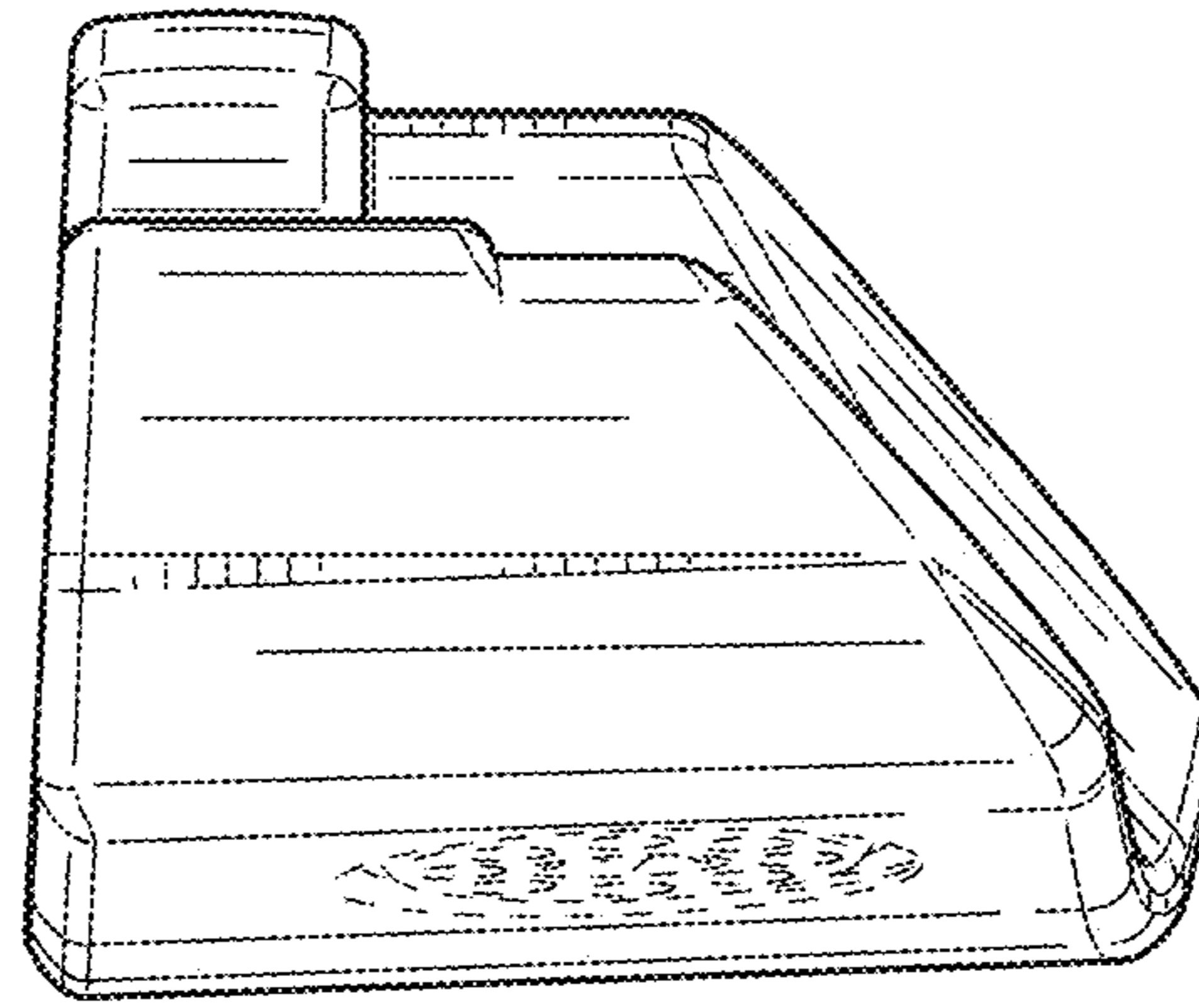

FIG. 15

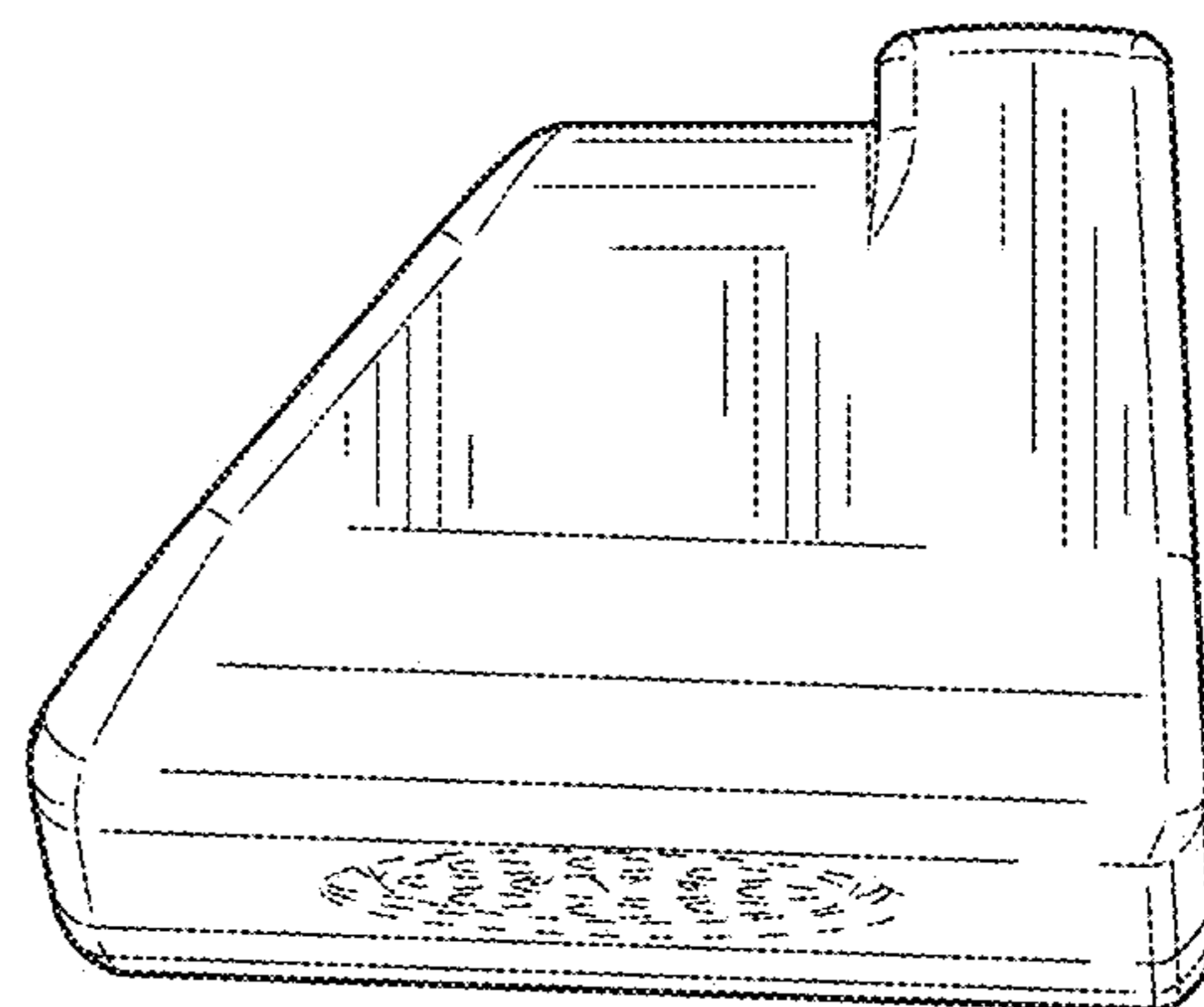

FIG. 16