



US00D924335S

(12) **United States Design Patent** (10) **Patent No.:** **US D924,335 S**
Chatterjee et al. (45) **Date of Patent:** **** Jul. 6, 2021**

(54) **CONSOLE WITH ILLUMINATION**

OTHER PUBLICATIONS

(71) Applicant: **Microsoft Corporation**, Redmond, WA (US)

Oct. 12, 2017 (TW) Search Report—App 105306789.
(Continued)

(72) Inventors: **Monique Chatterjee**, Seattle, WA (US);
Matthew C. Harvey, Seattle, WA (US);
Austin R. Porter, Salem, MA (US);
Richard T. Hanks, Arlington, MA (US)

Primary Examiner — Sandra Snapp
Assistant Examiner — Mehri Bajoul
(74) *Attorney, Agent, or Firm* — Banner & Witcoff, Ltd.

(73) Assignee: **Microsoft Corporation**, Redmond, WA (US)

(57) **CLAIM**

The ornamental design for a console with illumination, as shown and described.

(*) Notice: This patent is subject to a terminal disclaimer.

DESCRIPTION

(**) Term: **15 Years**

FIG. 1 is a top front perspective view of a console with illumination showing our new design in a non-illuminated state;

(21) Appl. No.: **29/704,062**

FIG. 2 is a bottom front perspective view thereof;

(22) Filed: **Aug. 30, 2019**

FIG. 3 is a front view thereof;

(51) **LOC (13) Cl.** **21-01**

FIG. 4 is a rear view thereof;

(52) **U.S. Cl.**

FIG. 5 is a right side view thereof;

USPC **D21/332**

FIG. 6 is a left side view thereof;

(58) **Field of Classification Search**

USPC D21/324, 330, 332, 333; D14/299, 496,
D14/502, 505, 506; D13/168

FIG. 7 is a top view thereof;

FIG. 8 is a bottom view thereof;

(Continued)

FIG. 9 is a top front perspective view of the console with illumination of FIGS. 1-8 showing an illuminated state;

(56) **References Cited**

U.S. PATENT DOCUMENTS

D139,369 S 11/1944 Dann
D287,365 S 12/1986 Judd

FIG. 10 is a bottom front perspective view thereof;

FIG. 11 is a front view thereof;

FIG. 12 is a rear view thereof;

FIG. 13 is a right side view thereof;

FIG. 14 is a left side view thereof;

FIG. 15 is a top view thereof; and,

FIG. 16 is a bottom view thereof.

(Continued)

The broken lines in the drawings depict portions of the console with illumination that form no part of the claimed design. The gray oblong features and the text, in FIGS. 1-3, 7 and 8, show the claimed design in an unilluminated state and the black oblong features and the text, in FIGS. 9-11, 15 and 16, show the claimed design in an illuminated state.

FOREIGN PATENT DOCUMENTS

JP 2002246639 A 8/2002
JP 2002323633 A 11/2002

(Continued)

1 Claim, 16 Drawing Sheets

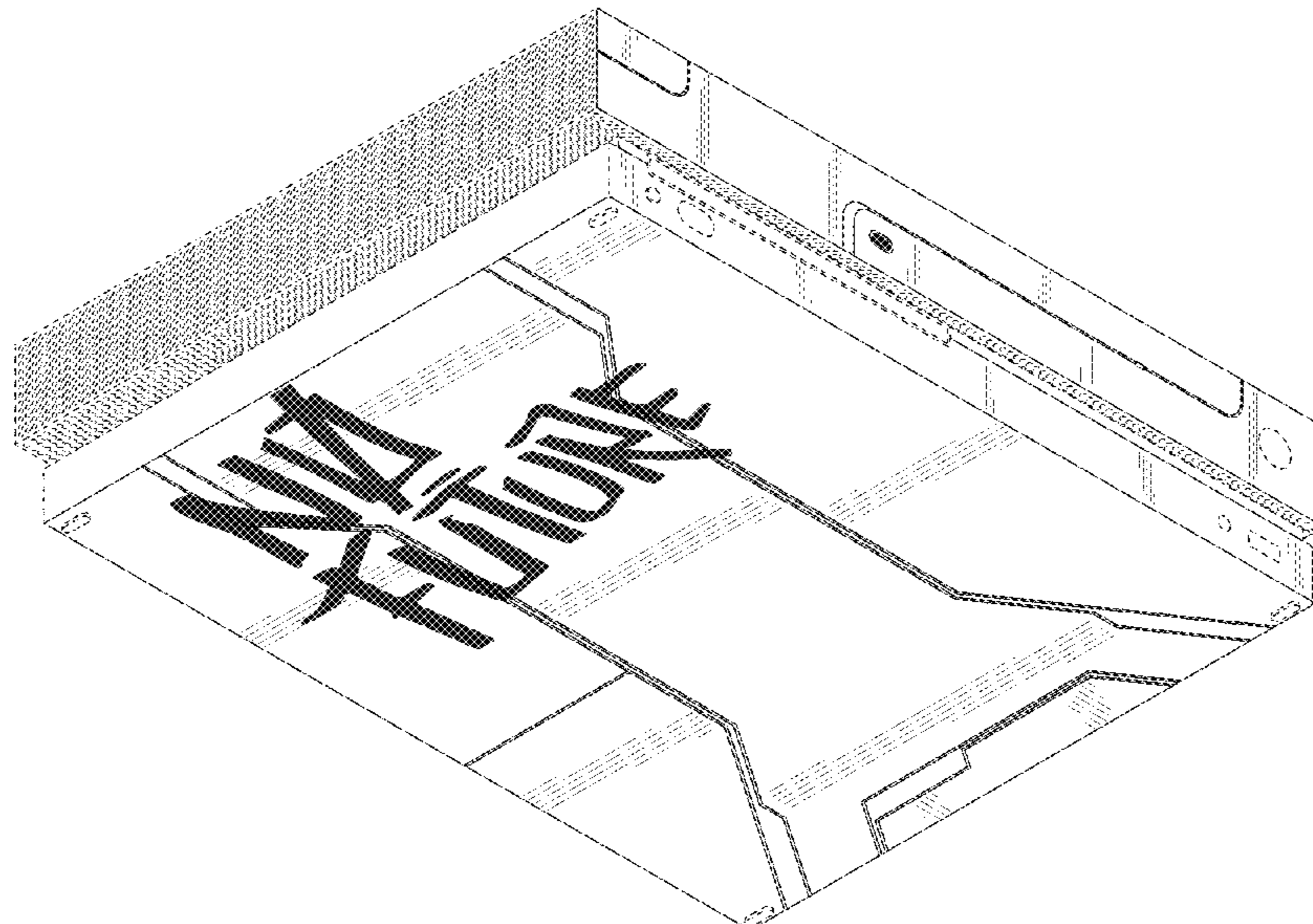

(58) **Field of Classification Search**
 CPC A63F 13/24; A63F 9/00; A63F 9/24; A63F
 11/00; A63F 13/00; A63F 13/02; A63F
 2300/00; G07F 17/00
 See application file for complete search history.

(56) **References Cited**

U.S. PATENT DOCUMENTS

D293,493 S	12/1987	Gaff	
D327,991 S	7/1992	Oldorf	
D330,021 S	10/1992	Kline et al.	
5,196,993 A	3/1993	Herron et al.	
D336,287 S	6/1993	Mizusugi et al.	
D338,882 S	8/1993	Reiter	
D341,280 S	11/1993	Garmon	
D362,243 S	9/1995	Spechts et al.	
D369,789 S	5/1996	Lucente, II et al.	
D378,676 S	4/1997	Goodman et al.	
D393,451 S	4/1998	Faranda et al.	
D395,640 S	6/1998	Goodman et al.	
D402,641 S	12/1998	Heijnen	
5,914,707 A	6/1999	Kono	
D412,319 S	7/1999	Lee et al.	
D415,740 S	10/1999	Lee et al.	
D415,741 S	10/1999	Lee et al.	
D416,547 S	11/1999	Lee et al.	
D425,731 S	5/2000	So	
6,115,249 A	9/2000	Cipolla et al.	
D435,272 S	12/2000	Swanson et al.	
D438,543 S	3/2001	Goto	
D441,759 S	5/2001	Goto	
D452,282 S	12/2001	Stewart et al.	
D452,495 S	12/2001	Murnaghan et al.	
D452,867 S	1/2002	Goto	
D454,136 S	3/2002	Deuschle	
D458,269 S	6/2002	Goto	
6,497,013 B1	12/2002	Goto et al.	
D472,403 S	4/2003	Bogish et al.	
6,565,444 B2	5/2003	Nagata et al.	
6,599,194 B1	7/2003	Smith et al.	
D486,492 S	2/2004	Sheu et al.	
6,908,387 B2	6/2005	Hedrick et al.	
6,930,600 B1	8/2005	Hsieh	
6,941,181 B1	9/2005	Mathurin	
D512,699 S *	12/2005	Ng	D14/135
D513,267 S *	12/2005	Chen	D14/496
D513,414 S *	1/2006	Nagao	D14/496
D514,563 S *	2/2006	Kuramashi	D14/349
D515,546 S *	2/2006	Mu	D14/203.3
D516,055 S *	2/2006	Chen	D14/188
D517,032 S *	3/2006	Carbone	D14/496
D517,514 S *	3/2006	Wu	D14/167
D519,978 S *	5/2006	Sogabe	D14/506
D524,242 S	7/2006	Adams et al.	
7,090,582 B2	8/2006	Danieli et al.	
D554,582 S	11/2007	Iseki	
D557,680 S	12/2007	Corsini	
D561,186 S	2/2008	Kawase	
D568,276 S	5/2008	Ikeda et al.	
D576,686 S	9/2008	Ashida et al.	
D606,094 S	12/2009	Kimura	
D610,625 S	2/2010	Guinchard et al.	
D641,024 S	7/2011	Zenri et al.	
D647,918 S	11/2011	Ledbetter et al.	
D650,448 S	12/2011	Zenri et al.	
D655,351 S	3/2012	Zenri et al.	
D656,555 S	3/2012	Zenri et al.	
D657,788 S	4/2012	Ledbetter et al.	
D664,993 S	8/2012	Ledbetter et al.	
D665,424 S	8/2012	Ledbetter et al.	
D666,680 S	9/2012	Mercier et al.	
D680,174 S	4/2013	Mercier et al.	
D685,795 S	7/2013	Paschke et al.	
D692,009 S	10/2013	Ashida et al.	
D692,437 S	10/2013	Sugino et al.	
D693,297 S	11/2013	Inskeep	

D700,246 S	2/2014	Jacobs et al.	
D701,213 S	3/2014	Pajic	
D705,361 S	5/2014	Jacobs et al.	
D705,869 S	5/2014	Jacobs et al.	
D705,870 S	5/2014	Jacobs et al.	
D705,871 S	5/2014	Jacobs et al.	
D708,971 S *	7/2014	Jacobs	D10/70
D709,133 S	7/2014	Jacobs et al.	
D709,134 S	7/2014	Dallmeyer et al.	
D709,959 S	7/2014	Jacobs et al.	
D711,258 S *	8/2014	Jacobs	D10/70
D711,885 S	8/2014	Ohshima et al.	
D711,923 S	8/2014	Dallmeyer et al.	
D712,350 S	9/2014	Smith et al.	
D713,420 S	9/2014	Dallmeyer et al.	
D719,958 S	12/2014	Dallmeyer et al.	
D721,138 S	1/2015	Barinaga et al.	
D722,116 S	2/2015	Gottschalk	
D723,469 S *	3/2015	Morris	D13/147
D725,658 S	3/2015	Stevenson et al.	
D726,729 S	4/2015	Lim	
D730,905 S	6/2015	Li	
D732,036 S	6/2015	Lee et al.	
D747,322 S	1/2016	Li	
D766,984 S	9/2016	Chatterjee et al.	
D766,985 S	9/2016	Chatterjee et al.	
D768,639 S	10/2016	Sumii	
D782,536 S *	3/2017	Chu	D14/496
D783,397 S *	4/2017	Riffe	D9/434
D791,804 S *	7/2017	Reyes	D14/486
D798,955 S *	10/2017	Chatterjee	D21/333
D805,067 S *	12/2017	Sparks	D14/332
D805,086 S	12/2017	Sparks et al.	
D805,130 S *	12/2017	Sparks	D21/332
D805,131 S *	12/2017	Sparks	D21/332
D805,132 S	12/2017	Sparks et al.	
D805,133 S	12/2017	Sparks et al.	
D810,118 S *	2/2018	Chen	D14/487
D812,048 S *	3/2018	Mazz	D14/341
D820,358 S *	6/2018	Sparks	D21/332
D826,334 S	8/2018	Christie et al.	
D826,335 S	8/2018	Christie et al.	
D826,336 S *	8/2018	Christie	D21/332
D826,337 S *	8/2018	Christie	D21/332
D827,032 S	8/2018	Christie et al.	
D839,353 S *	1/2019	Christie	D21/332
D839,355 S	1/2019	Christie et al.	
D843,351 S *	3/2019	Osborn	D14/214
D843,455 S *	3/2019	Lee	D20/27
D844,578 S *	4/2019	Seflic	D14/125
D867,459 S *	11/2019	Chatterjee	D21/333

FOREIGN PATENT DOCUMENTS

JP	2003008054 A	1/2003
TW	D169552	8/2015

OTHER PUBLICATIONS

Oct. 12, 2017 (TW) Search Report—App 105306784.
 Oct. 12, 2017 (TW) Search Report—App 105306782.
 Oct. 12, 2017 (TW) Search Report—App 105306781.
 Apr. 11, 2018—U.S. Non-Final Office Action—U.S. Appl. No. 29/607,124.
 Apr. 11, 2018—U.S. Non-Final Office Action—U.S. Appl. No. 29/607,129.
 Apr. 18, 2018—U.S. Notice of Allowance—U.S. Appl. No. 29/607,132.
 Apr. 12, 2018—U.S. Notice of Allowance—U.S. Appl. No. 29/607,139.
 Apr. 11, 2018—U.S. Non-Final Office Action—U.S. Appl. No. 29/607,141.
 Apr. 12, 2018—U.S. Notice of Allowance—U.S. Appl. No. 29/607,147.
 Apr. 12, 2018—U.S. Notice of Allowance—U.S. Appl. No. 29/607,149.
 Apr. 12, 2018—U.S. Notice of Allowance—U.S. Appl. No. 29/607,151.
 “Office Action Issued in Indian Patent Application No. 300200”, dated Jan. 2, 2018, 2 Pages.
 “Office Action Issued in Indian Patent Application No. 300201”, dated Jan. 10, 2018, 2 Pages.

(56)

References Cited

OTHER PUBLICATIONS

“Office Action Issued in Indian Patent Application No. 300202”, dated Jan. 29, 2018, 2 Pages.

Way Back Machine [online], [retrieved Jan. 16, 2013]. Retrieved from internet, <http://web.archive.org/web/20130116120917/http://www.klipsch.com/gallery-g17-air>.

Nintendo NES [online], [retrieved on May 14, 2013]. Retrieved from internet, <http://gamesdbase.com/system-nintendo_nes.aspx/>.

“Nintendo Wii Review”, Top 10 Reviews ; URL: <<http://www.toptenreviews.com/electronics/gaming/best-video-game-consoles/nintendo-wii/review/>> ; date accessed Sep. 27, 2016.

“PS4 Console”, PS4 Features, Games & Videos ; <URL:<https://www.playstation.com/en-us/explore/ps4/>> ; date accessed Sep. 27, 2016.

“Sony Playstation 2”, The Video Game Critic’s Console Reviews ; <URL:<http://videogamecritic.com/ps2info.htm>> ; date accessed Sep. 27, 2016.

X Box One S found online [Nov. 2, 2016] http://www.xbox.com/en-us/xbox-one-s?&ocid=PORTALS_SEM_google_microsoft%20xbox&cid=PORTALS_SEM_google_microsoft%20xbox.

Nov. 30, 2016—U.S. Non-Final Office Action—U.S. Appl. No. 29/564,527, filed May 13, 2016; Inv.: Bryan A. Sparks.

Nov. 28, 2016—U.S. Non-Final Office Action—U.S. Appl. No. 29/564,514, filed May 13, 2016; Inv.: Bryan A. Sparks.

Nov. 30, 2016—U.S. Non-Final Office Action—U.S. Appl. No. 29/564,511, filed May 13, 2016; Inv.: Bryan A. Sparks.

Nov. 28, 2016—U.S. Non-Final Office Action—U.S. Appl. No. 29/564,518, filed May 13, 2016; Inv.: Bryan A. Sparks.

Nov. 30, 2016—U.S. Non-Final Office Action—U.S. Appl. No. 29/564,522, filed May 13, 2016; Inv.: Bryan A. Sparks.

AVS Forum; “Receivers, Amps, and Processors”; Publication date unknown but prior to filing date of present application; Date Accessed: Jul. 25, 2017; URL: <<http://www.avforums.com/forum/90-receivers-amps-processors/1502957-onkyo-tx-sr601-any-good.html>>.

Ixbt.com; “DolbyDigital Surround EX, DTS-ES 6.1”; Publication date unknown but prior to filing date of present application; Date Accessed: Jul. 25, 2017; URL: <<http://www.ixbt.com/dvd/onkyo-tx-sr-600.shtml>>.

Grey Ghost; “Insignia NS-R2000 Stereo Receiver Review”; Publication date unknown but prior to filing date of present application; Date Accessed: Jul. 25, 2017; URL: <<http://greyghost.mooc.com/nsr2000-review/>>.

Crutch Field; “Cambridge Audio Topaz SR20”; Publication date unknown but prior to filing date of present application; Date Accessed: Jul. 25, 2017; URL: <https://www1.crutchfield.com/p_779SR20/Cambridge-Audio-Topaz-SR20.html>.

Stereophile; “Arcam FMJ SR250 stereo AV receiver”; Publication date: Jun. 1, 2017; Date Accessed: Jul. 25, 2017; URL: <<https://www.stereophile.com/taxonomy/term-p/143>>.

Electronic House; “Affordable 2-channel Receivers for Great Home Stereo Systems”; Publication date: Apr. 1, 2015; Date Accessed: Jul. 25, 2017; URL: <<https://www.electronichouse.com/home-audio/affordable-2-channel-receivers-great-home-stereo-systems/>>.

Audi Affair; “Arcam FMJ C49 Pre Amplifier”; Publication date unknown but prior to filing date; Date Accessed: Jul. 25, 2017; URL: <<http://www.audioaffair.co.uk/arcam-c49-pre-amplifier>>.

Hifi-Prestige; “Arcam FMJ A 39”; Publication date unknown but prior to filing date; Date Accessed: Jul. 25, 2017; URL: <<http://www.hifiprestige.it/it/amplificatori-integrati/7517-arcam-fmj-a-39.html>>.

Hifi-Prestige; “Arcam FMJ AVR 550”; Publication date unknown but prior to filing date; Date Accessed: Jul. 25, 2017; URL: <<http://www.hifiprestige.it/it/sintoamplificatori-a-v/9343-arcam-fmj-avr-550.html>>.

Hifi-Prestige; “Arcam FMJ C 49”; Publication date unknown but prior to filing date; Date Accessed: Jul. 25, 2017; URL: <<http://www.hifiprestige.it/it/preamplificatori/7514-arcam-fmj-c-49.html>>.

Hifi-Prestige; “Arcam FMJ UDP 411”; Publication date unknown but prior to filing date; Date Accessed: Jul. 25, 2017; URL: <<http://www.hifiprestige.it/it/accessori-multimediali/7519-arcam-fmj-udp-411.html>>.

Hifi-Prestige; “Arcam FMJ A19 Black—Amplificatore Integrato”; Publication date unknown but prior to filing date; Date Accessed: Jul. 25, 2017; URL: <<http://www.hifiprestige.it/it/amplificatori-integrati/6523-arcam-fmj-a19-black.html>>.

Best Buy; “Insignia—200W 2.0-Ch. Stereo Receiver—Black”; Publication date unknown but prior to filing date; Date Accessed: Jul. 25, 2017; URL: <<http://www.bestbuy.com/site/insignia-200w-2-0-ch-stereo-receiver-black/4156007.p?skuId=4156007>>.

Best Buy; “Yamaha—165W 2.0-Ch. Stereo Receiver—Black”; Publication date unknown but prior to filing date; Date Accessed: Jul. 25, 2017; URL: <<http://www.bestbuy.com/site/yamaha-165w-2-0-ch-stereo-receiver-black/3817026.p?skuId=3817026>>.

Best Buy; “Denon—AVR 5.2-Ch. 4K Ultra HD and 3D Pass-Through A/V Home Theater Receiver—Black”; Publication date unknown but prior to filing date; Date Accessed: Jul. 25, 2017; URL: <<http://www.bestbuy.com/site/denon-avr-5-2-th-4k-ultra-hd-and-3d-pass-through-a-v-home-theater-receiver-black/5756606.p?skuId=5756606>>.

Best Buy; “Yamaha—5.1-Ch. 4K Ultra HD and 3D Pass-Through A/V Home Theater Receiver—Black”; Publication date unknown but prior to filing date; Date Accessed: Jul. 25, 2017; URL: <<http://www.bestbuy.com/site/yamaha-5-1-ch-4k-ultra-hd-and-3d-pass-through-a-v-home-theater-receiver-black/5784593.p?skuId=5784593>>.

Apr. 5, 2017—U.S. Final Office Action—U.S. Appl. No. 29/564,511, filed May 13, 2016; Inv.: Bryan A. Sparks.

Aug. 21, 2017—U.S. Notice of Allowance—U.S. Appl. No. 29/564,511, filed May 13, 2016; Inv.: Bryan A. Sparks.

Jan. 3, 2014—U.S. Notice of Allowance—U.S. Appl. No. 29/447,078, filed Feb. 28, 2013; Inv.: Joel B. Jacobs.

Jan. 6, 2014—U.S. Non-Final Office Action—U.S. Appl. No. 29/447,082, filed Feb. 28, 2013; Inv.: Joel B. Jacobs.

Mar. 12, 2014—U.S. Notice of Allowance—U.S. Appl. No. 29/447,082, filed Feb. 28, 2013; Inv.: Joel B. Jacobs.

Jan. 6, 2014—U.S. Notice of Allowance—U.S. Appl. No. 29/447,085, filed Feb. 28, 2013; Inv.: Joel B. Jacobs.

Jan. 2, 2014—U.S. Requirement for Restriction—U.S. Appl. No. 29/447,089, filed Feb. 28, 2013; Inv.: Joel B. Jacobs.

Mar. 14, 2014—U.S. Notice of Allowance—U.S. Appl. No. 29/447,089, filed Feb. 28, 2013; Inv.: Joel B. Jacobs.

Jan. 6, 2014—U.S. Notice of Allowance—U.S. Appl. No. 29/447,094, filed Feb. 28, 2013; Inv.: Joel B. Jacobs.

Jan. 7, 2014—U.S. Notice of Allowance—U.S. Appl. No. 29/447,097, filed Feb. 28, 2013; Inv.: Joel B. Jacobs.

Jan. 7, 2014—U.S. Notice of Allowance—U.S. Appl. No. 29/447,100, filed Feb. 28, 2013; Inv.: Joel B. Jacobs.

Apr. 5, 2017—U.S. Final Office Action—U.S. Appl. No. 29/564,514, filed May 13, 2016; Inv.: Bryan A Sparks.

Aug. 23, 2017—U.S. Notice of Allowance—U.S. Appl. No. 29/564,514, filed May 13, 2016; Inv.: Bryan A Sparks.

Apr. 5, 2017—U.S. Final Office Action—U.S. Appl. No. 29/564,518, filed May 13, 2016; Inv.: Bryan A Sparks.

Aug. 23, 2017—U.S. Notice of Allowance—U.S. Appl. No. 29/564,518, filed May 13, 2016; Inv.: Bryan A Sparks.

Apr. 5, 2017—U.S. Final Office Action—U.S. Appl. No. 29/564,522, filed May 13, 2016; Inv.: Bryan A Sparks.

Aug. 23, 2017—U.S. Notice of Allowance—U.S. Appl. No. 29/564,522, filed May 13, 2016; Inv.: Bryan A Sparks.

Apr. 21, 2017—U.S. Non-Final Office Action—U.S. Appl. No. 29/566,652, filed Jun. 1, 2016; Inv.: Bryan A Sparks.

Sep. 13, 2017—U.S. Notice of Allowance—U.S. Appl. No. 29/566,652, filed Jun. 1, 2016; Inv.: Bryan A Sparks.

Jun. 1, 2017—U.S. Non-Final Office Action—U.S. Appl. No. 29/564,601, filed May 13, 2016; Inv.: Bryan A Sparks.

Apr. 5, 2017—U.S. Final Office Action—U.S. Appl. No. 29/564,527, filed May 13, 2016; Inv.: Bryan A Sparks.

Aug. 23, 2017—U.S. Notice of Allowance—U.S. Appl. No. 29/564,527, filed May 13, 2016; Inv.: Bryan A Sparks.

(56)

References Cited

OTHER PUBLICATIONS

“Non Final Office Action Issued in U.S. Appl. No. 29/704,059”,
dated Sep. 18, 2020, 11 Pages. (MS#407031-US-DP).

* cited by examiner

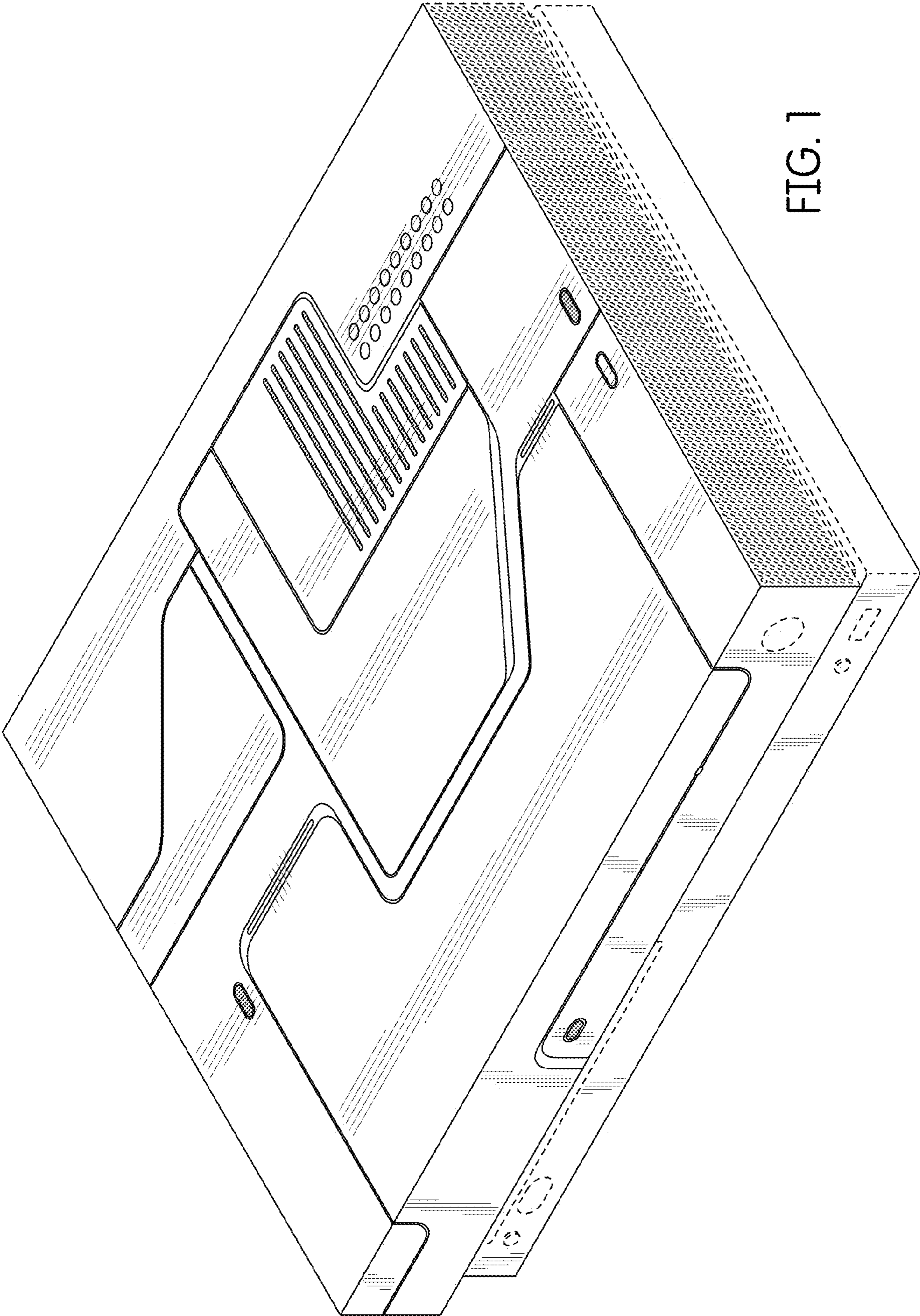

FIG. 1

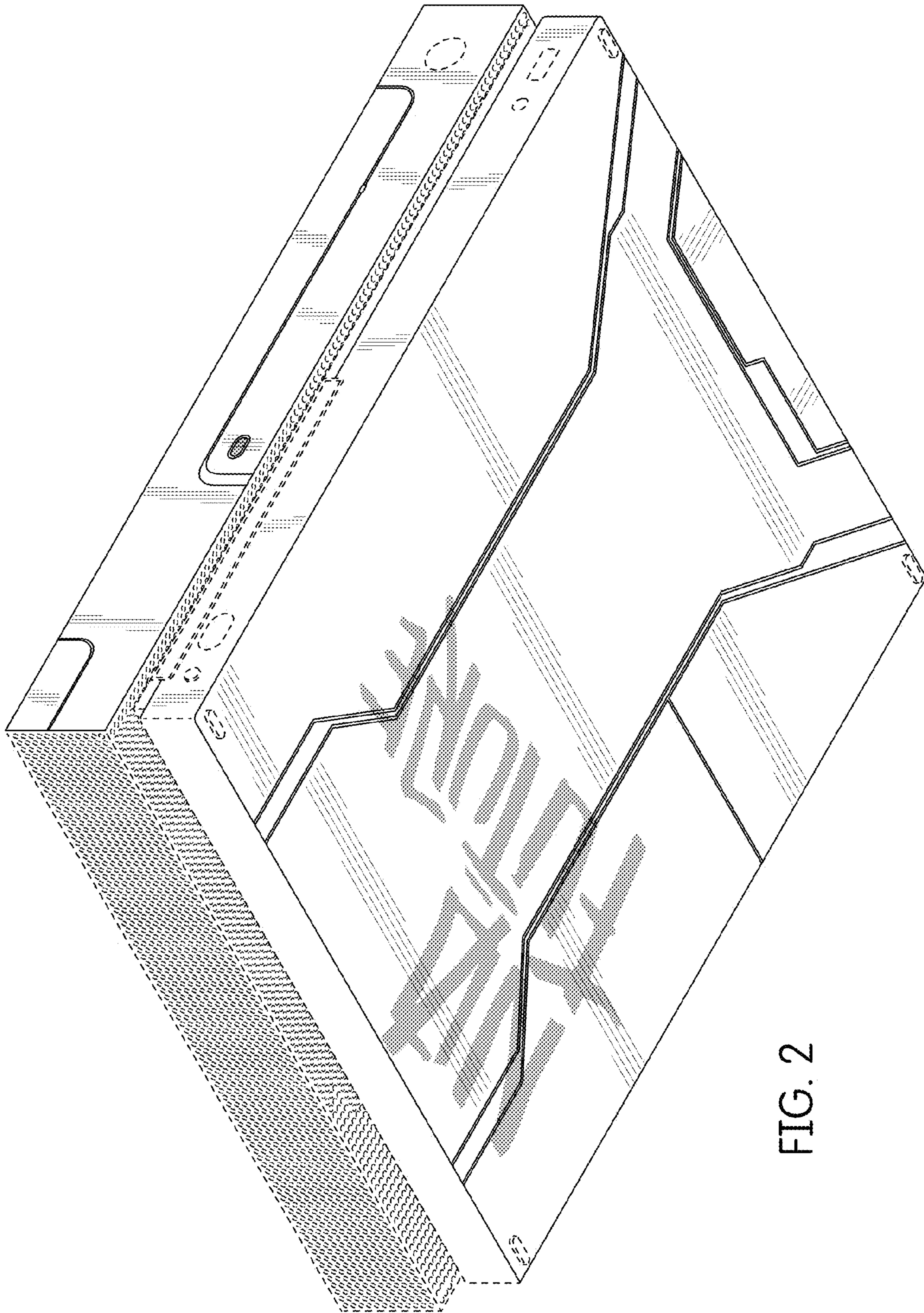

FIG. 2

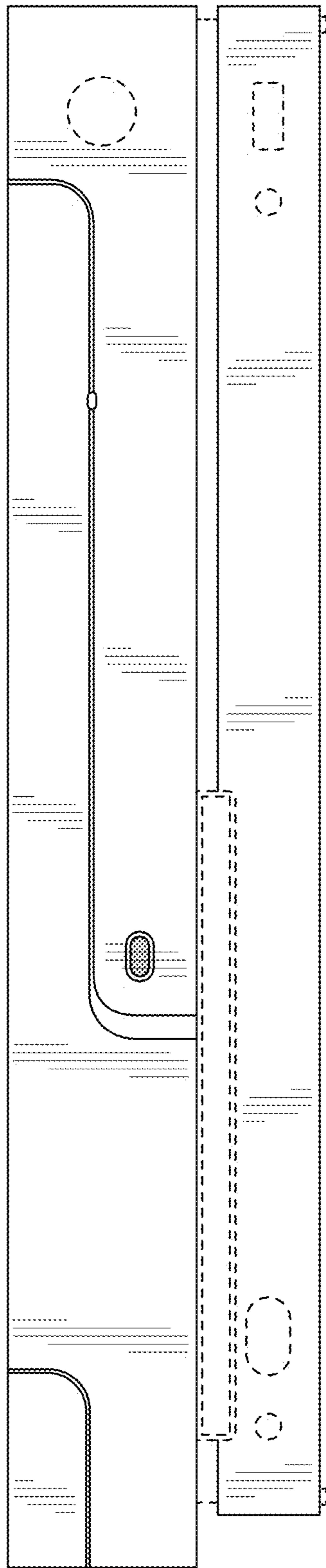

FIG. 3

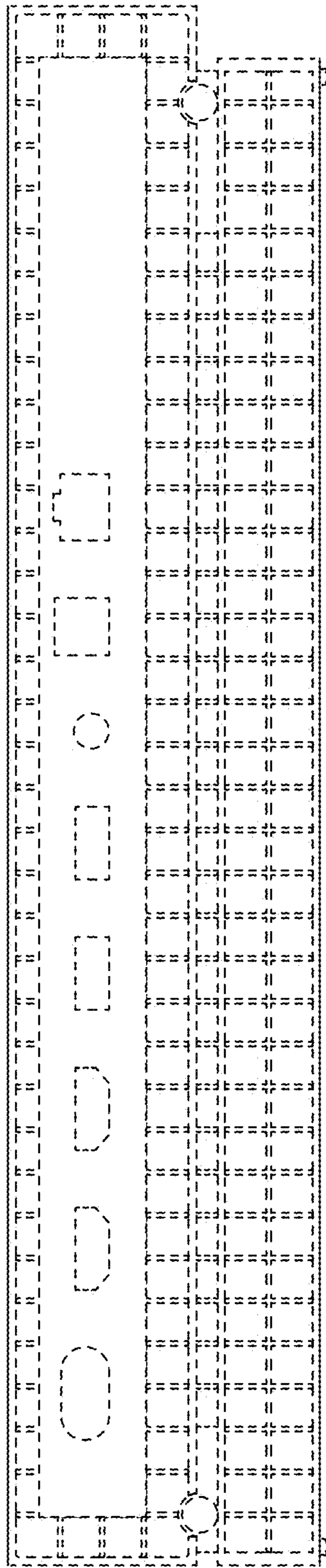

FIG. 4

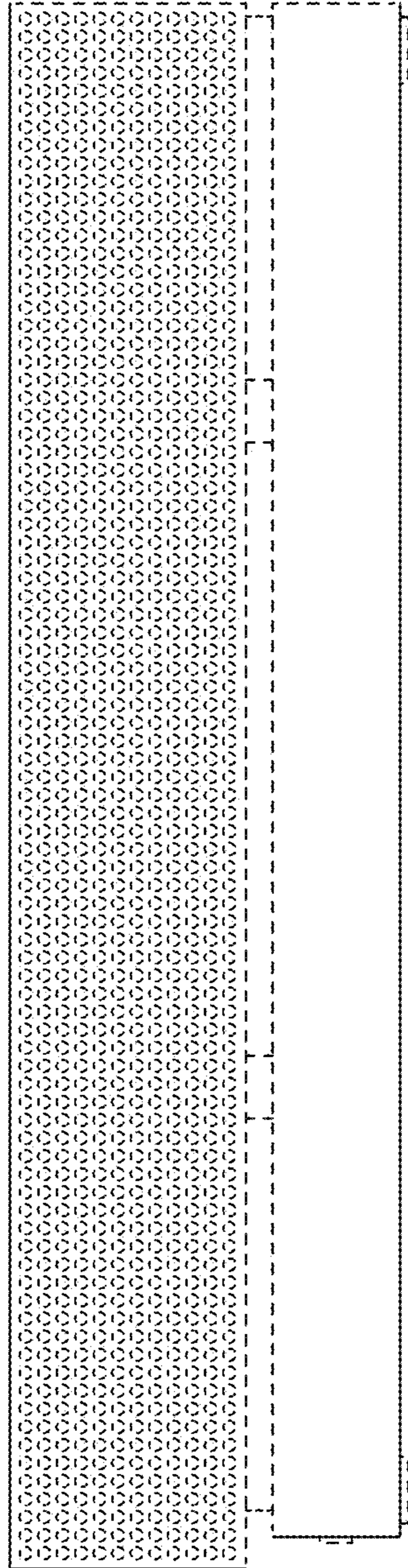

FIG. 5

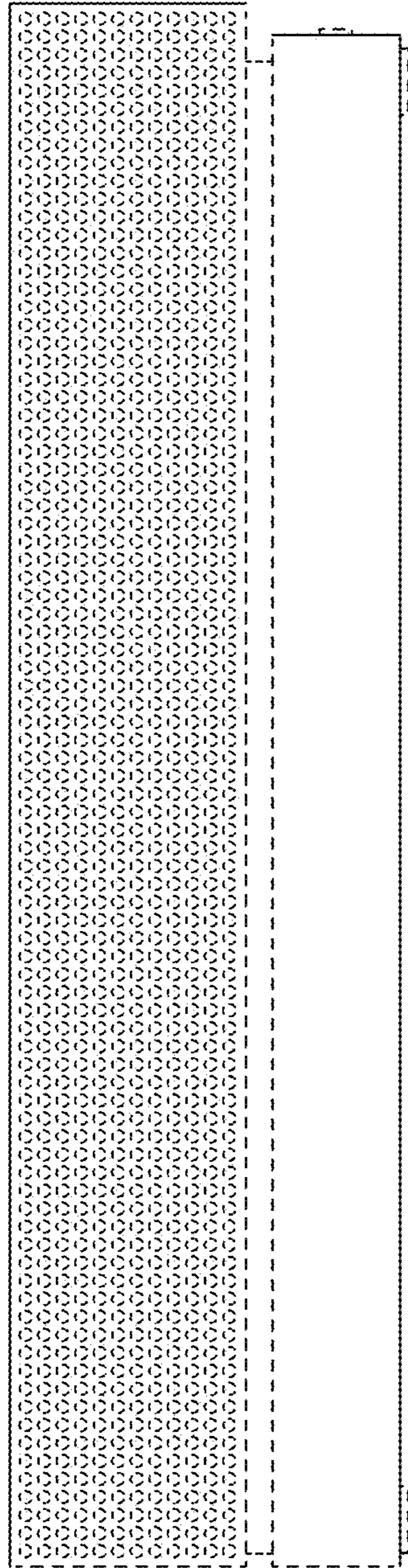

FIG. 6

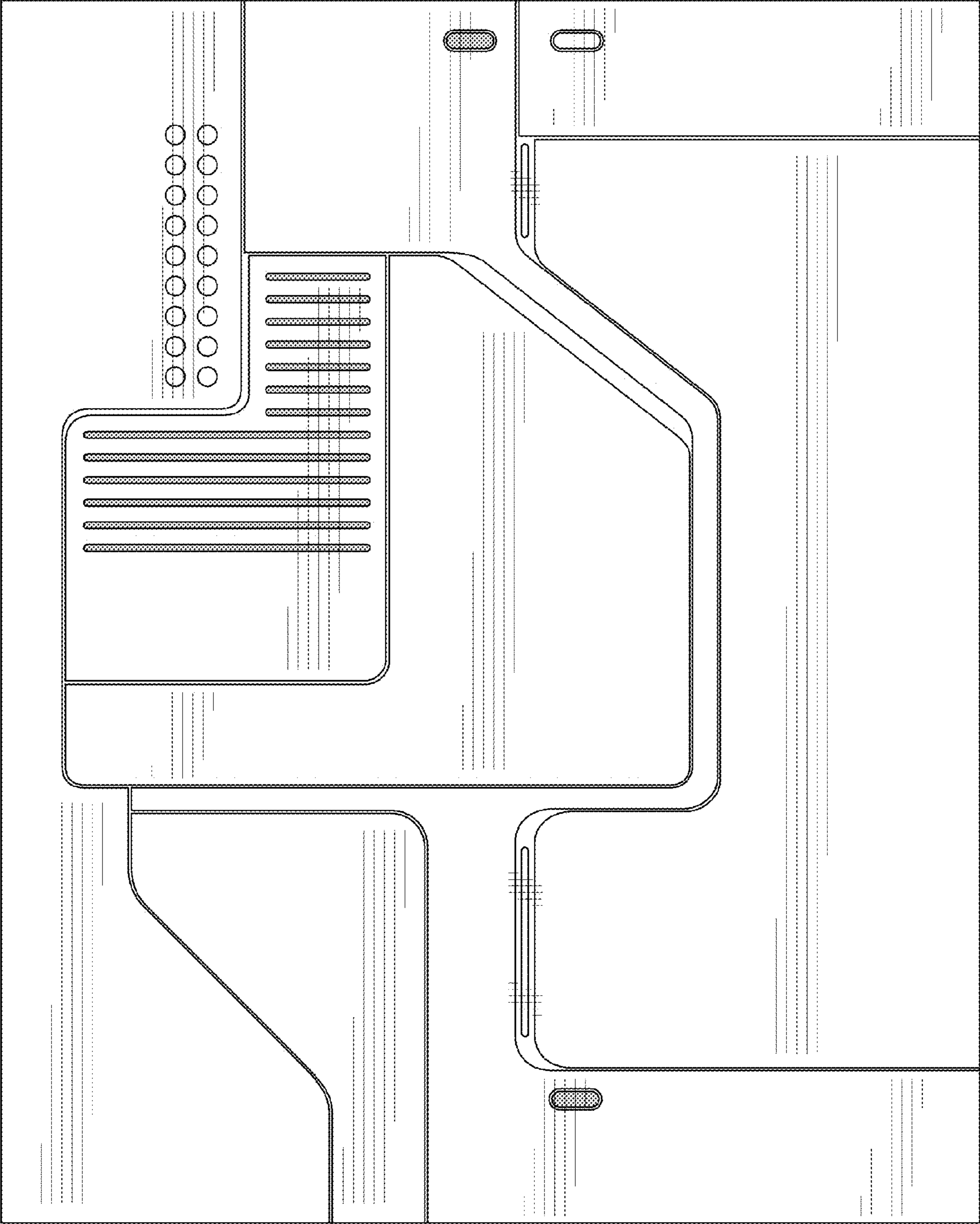

FIG. 7

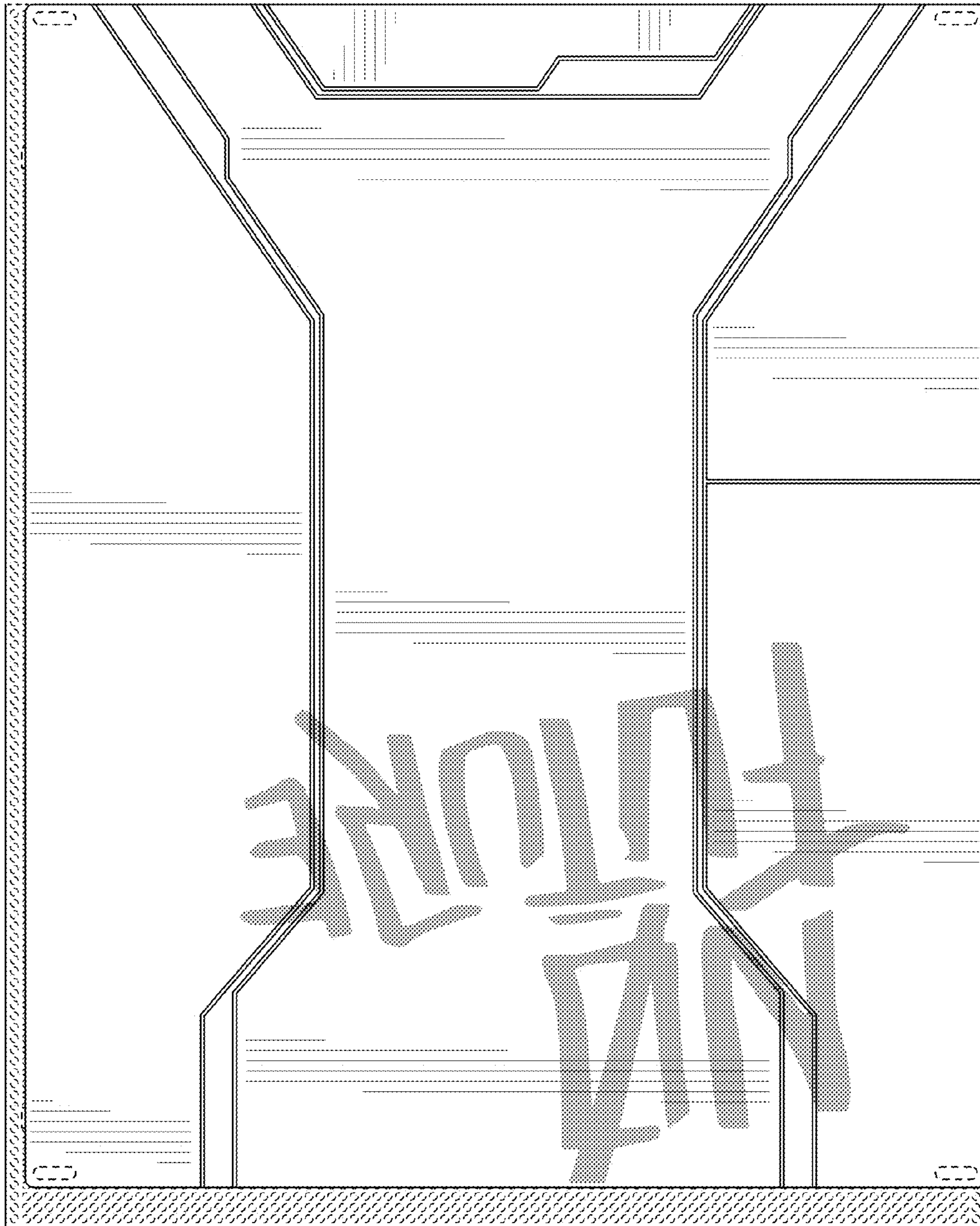

FIG. 8

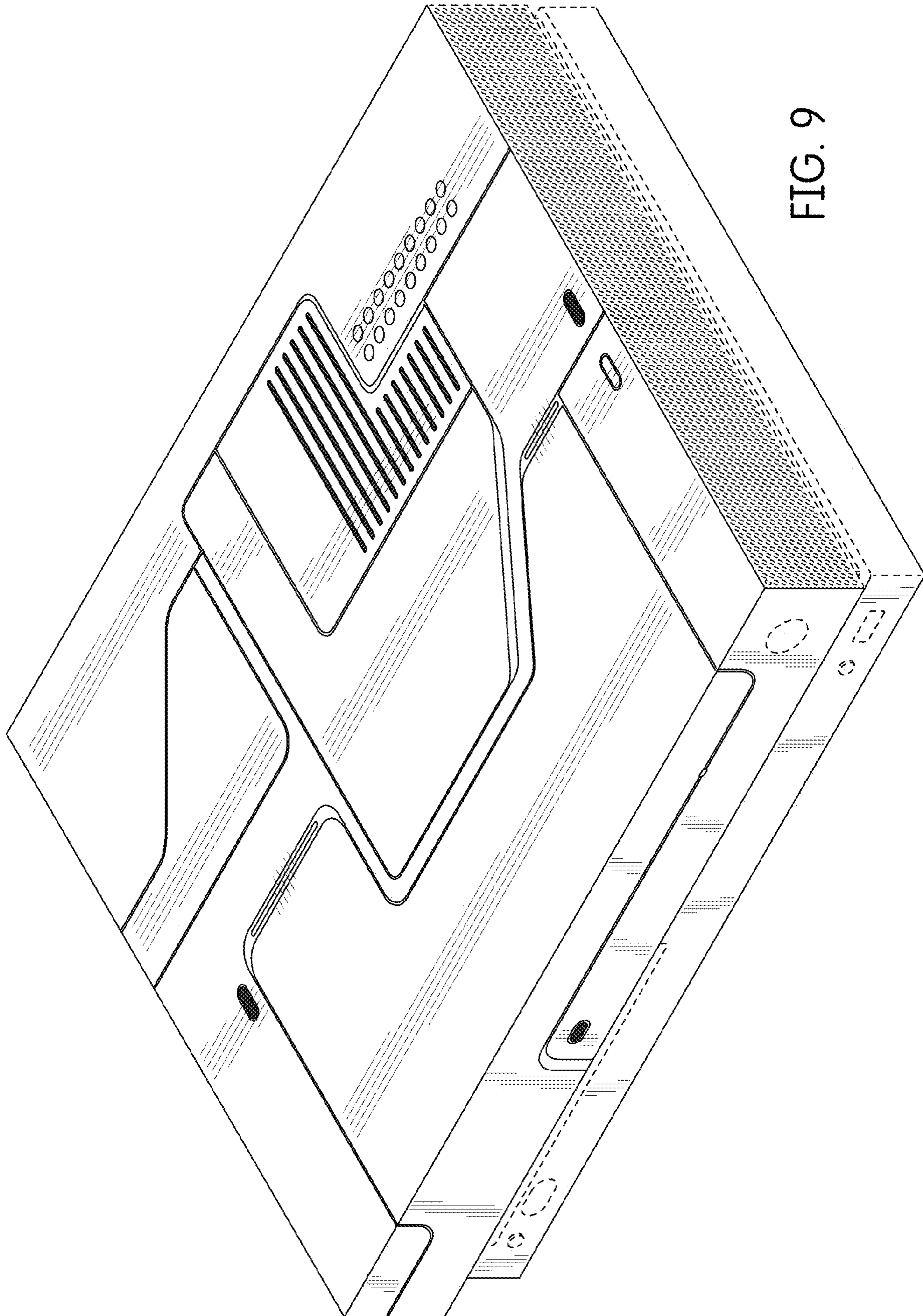

FIG. 9

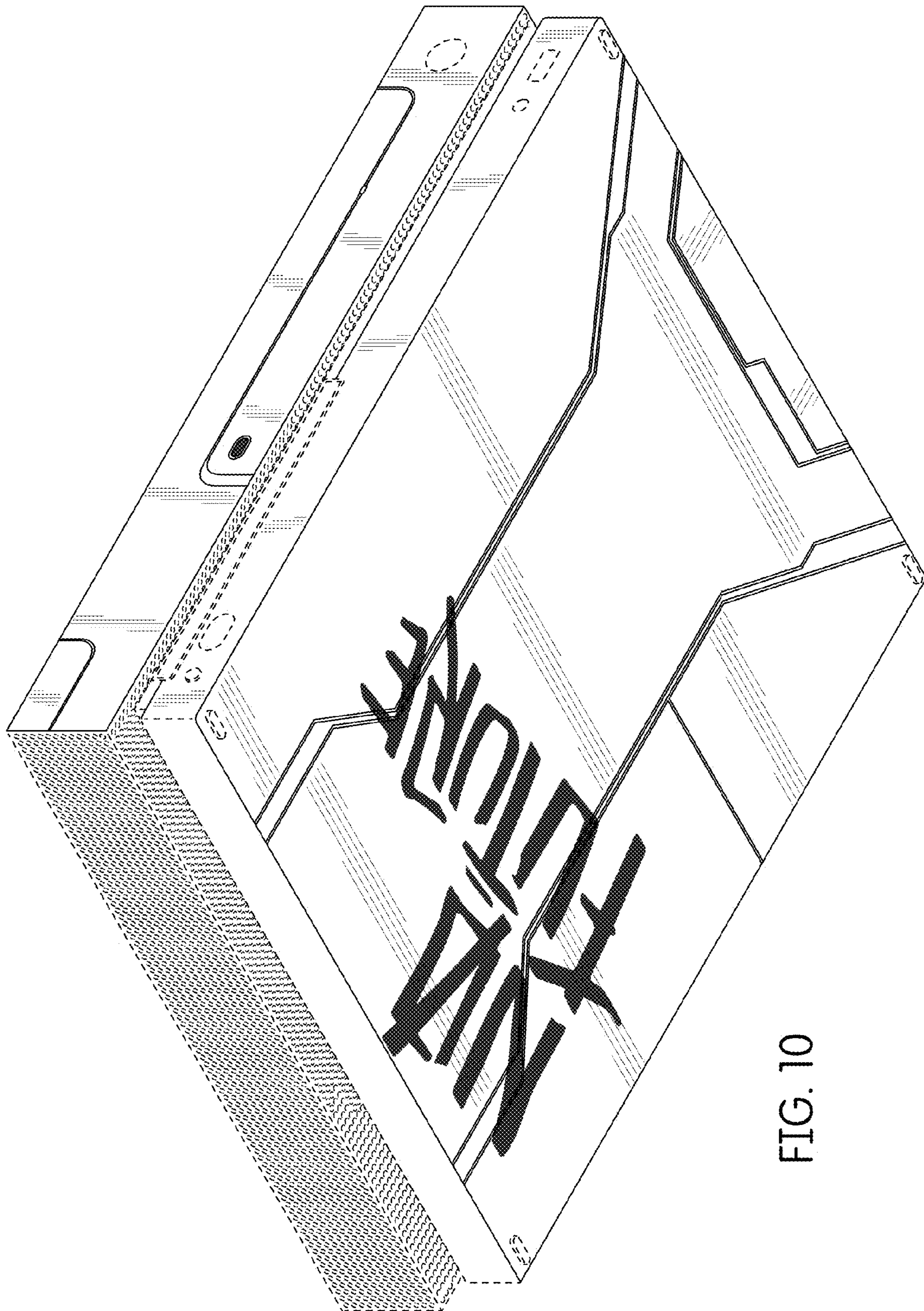

FIG. 10

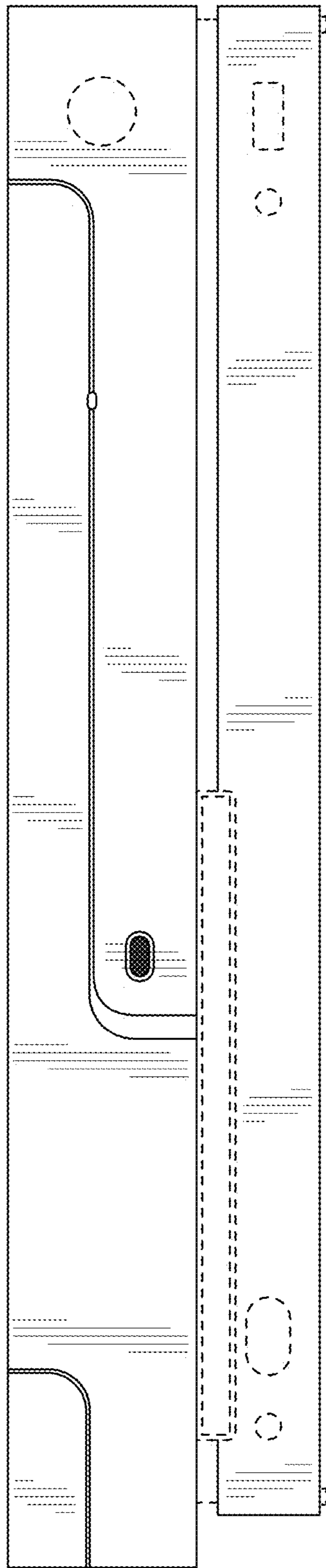

FIG. 11

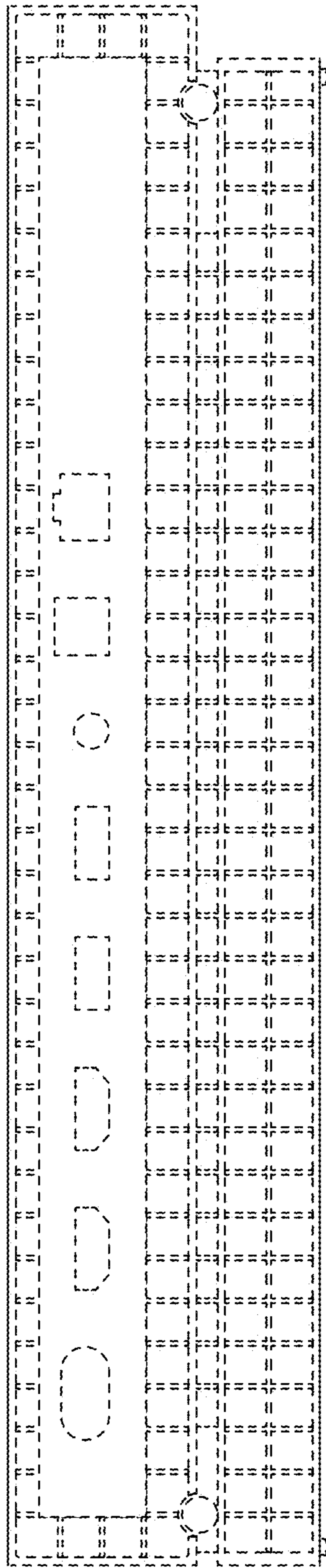

FIG. 12

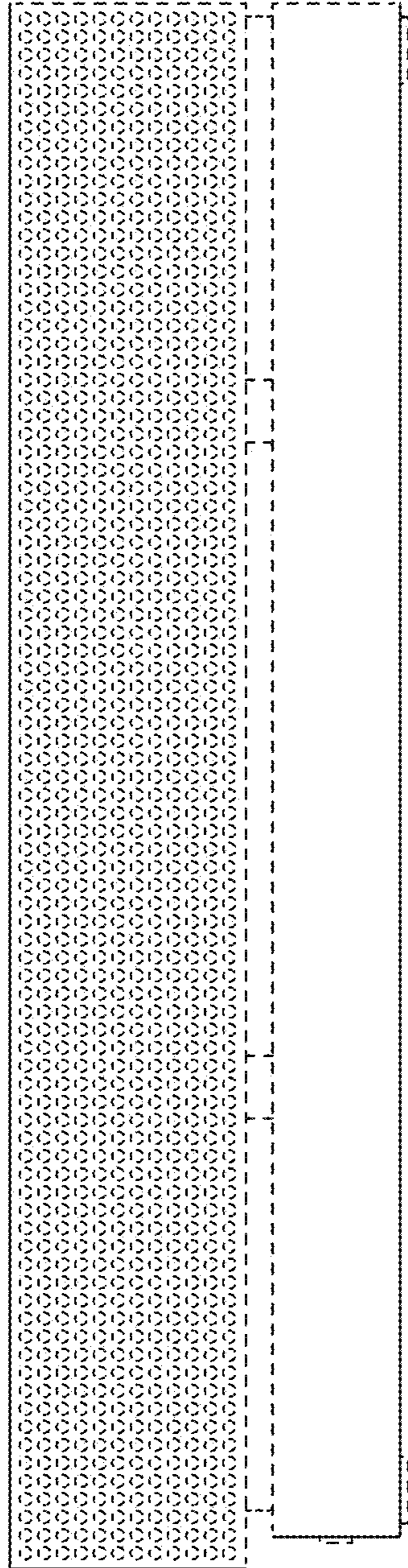

FIG. 13

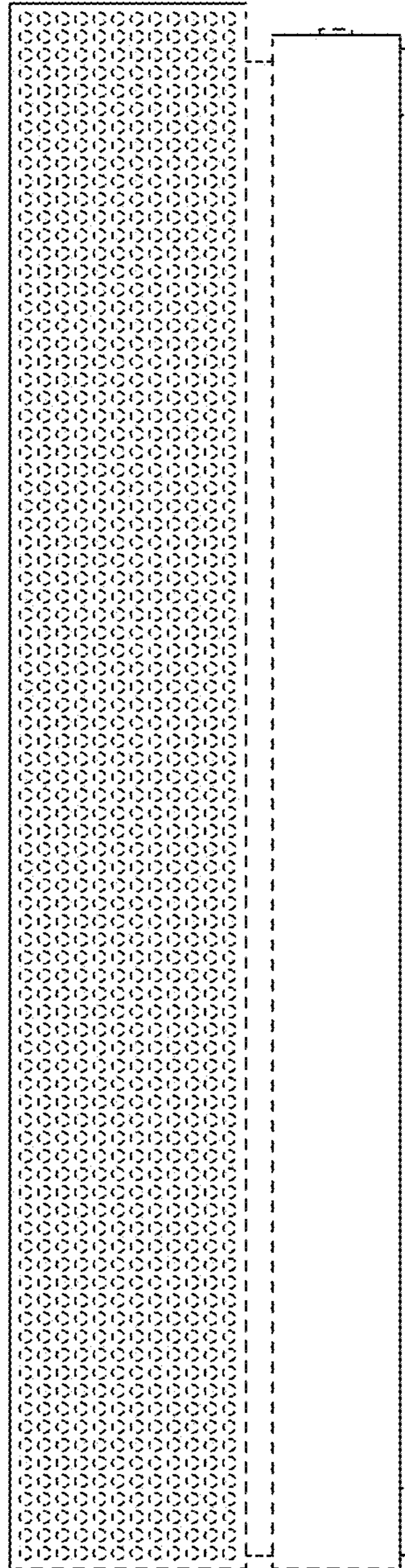

FIG. 14

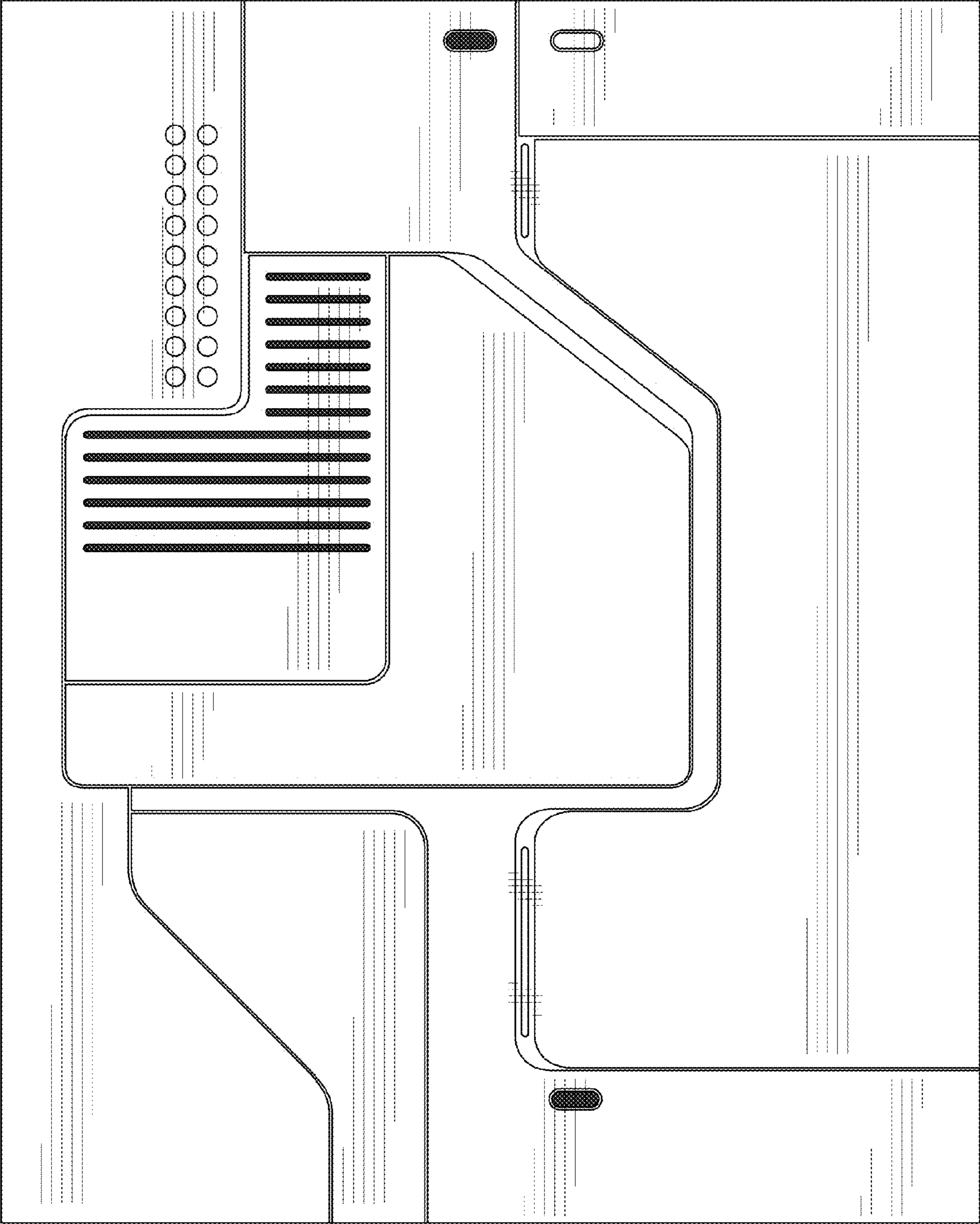

FIG. 15



FIG. 16