



US00D924193S

(12) **United States Design Patent** (10) **Patent No.:** **US D924,193 S**
Ryu et al. (45) **Date of Patent:** **** Jul. 6, 2021**

(54) **MOBILE PHONE**

FOREIGN PATENT DOCUMENTS

(71) Applicant: **Samsung Electronics Co., Ltd.**,
Suwon-si (KR)

CN 306004037 * 8/2020

(72) Inventors: **Jinie Ryu**, Suwon-si (KR); **Jongdeuk Son**, Suwon-si (KR); **Jaewoong Chung**, Suwon-si (KR); **Hyounghsin Park**, Suwon-si (KR)

OTHER PUBLICATIONS

Samsung Galaxy Note10, announced Aug. 7, 2019, [online], [retrieved on Apr. 21, 2021]. Retrieved from Internet ,<URL: <http://www.gsmaarena.com>>.*

(Continued)

(73) Assignee: **SAMSUNG ELECTRONICS CO., LTD.**, Suwon-si (KR)

Primary Examiner — Bridget L Eland

(74) *Attorney, Agent, or Firm* — McAndrews Held & Malloy, Ltd.

(*) Notice: This patent is subject to a terminal disclaimer.

(57) **CLAIM**

The ornamental design for a mobile phone, as shown and described.

(**) Term: **15 Years**

DESCRIPTION

(21) Appl. No.: **29/707,188**

(22) Filed: **Sep. 26, 2019**

(30) **Foreign Application Priority Data**

Jun. 14, 2019 (KR) 30-2019-0028375

(51) **LOC (13) Cl.** **14-03**

(52) **U.S. Cl.**
USPC **D14/138 G**

(58) **Field of Classification Search**
USPC .. D14/138 G, 248, 341, 345, 439, 432, 371,
D14/374, 138 R, 138 AA, 138 AB,
D14/138 AC, 138 AD, 138 C

(Continued)

(56) **References Cited**

U.S. PATENT DOCUMENTS

D676,011 S * 2/2013 Park D14/138 G
D699,700 S * 2/2014 Yoo D14/138 G

(Continued)

FIG. 1 is a front perspective view of a mobile phone showing our new design according to a first embodiment;
FIG. 2 is a front elevation view thereof;
FIG. 3 is a rear elevation view thereof;
FIG. 4 is a left side elevation view thereof;
FIG. 5 is a right side elevation view thereof;
FIG. 6 is a top plan view thereof;
FIG. 7 is a bottom plan view thereof;
FIG. 8 is a rear perspective view thereof;
FIG. 9 is a front perspective view of a mobile phone showing our new design according to a second embodiment;
FIG. 10 is a front elevation view thereof;
FIG. 11 is a rear elevation view thereof;
FIG. 12 is a left side elevation view thereof;
FIG. 13 is a right side elevation view thereof;
FIG. 14 is a top plan view thereof;
FIG. 15 is a bottom plan view thereof; and,
FIG. 16 is a rear perspective view thereof.
The dashed broken lines in the drawings depict portions of the mobile phone that form no part of the claimed design.

1 Claim, 12 Drawing Sheets

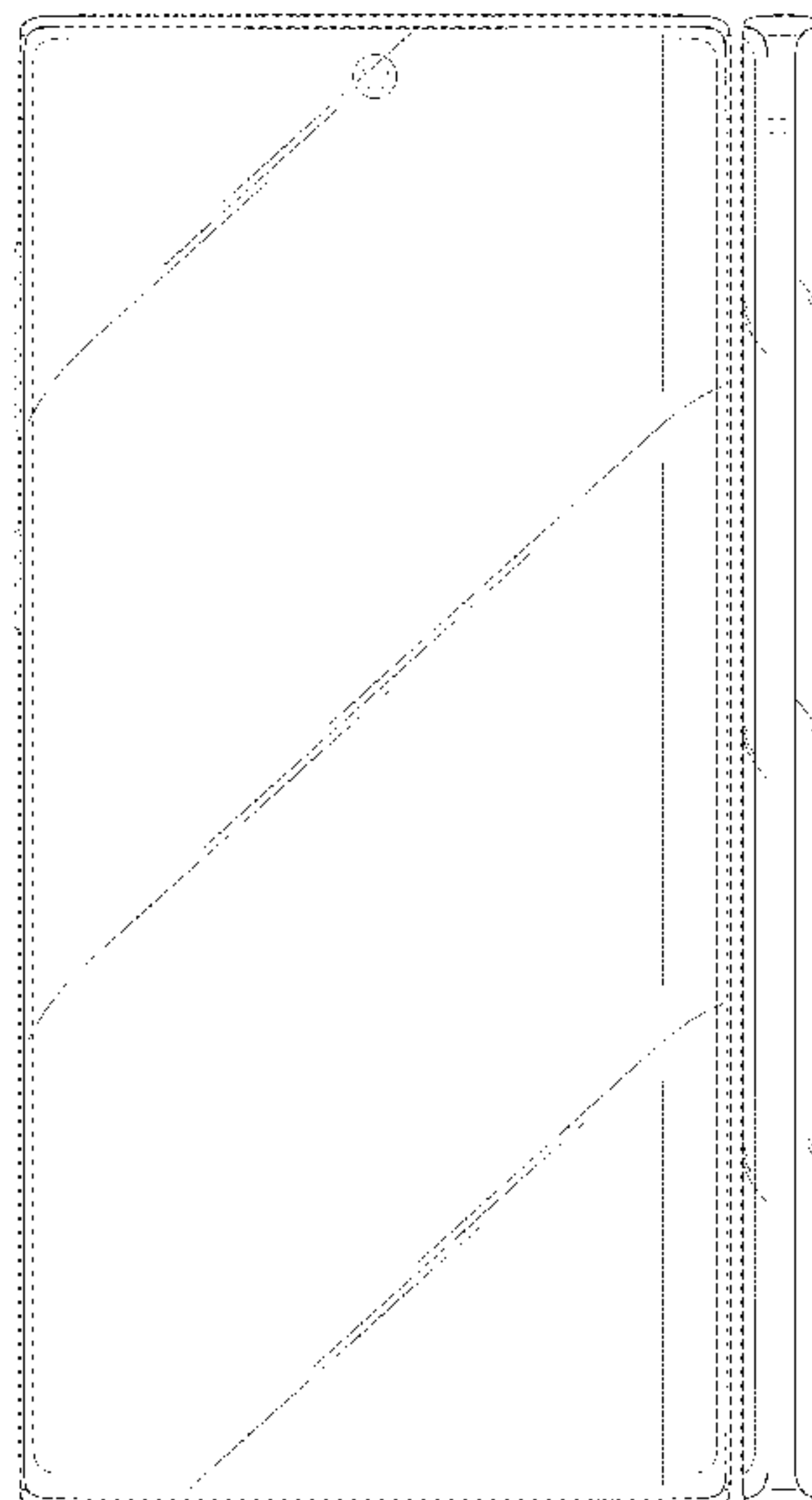

(58) **Field of Classification Search**

CPC H04M 1/0202; H04M 1/0235; H04M
1/0237; H04M 1/0239; H04M 1/0266;
H04M 1/0268; H04M 1/027; H04M
1/0295; H04M 1/02; H04M 1/0279;
H04M 1/0283

See application file for complete search history.

D800,683 S * 10/2017 Park D14/138 G
D801,297 S * 10/2017 Song D14/138 G
D820,800 S * 6/2018 Song D14/138 G
D848,388 S * 5/2019 Magi D14/138 G
D849,709 S * 5/2019 Choi D14/138 G
D855,032 S * 7/2019 Cho D14/138 G
D866,501 S * 11/2019 Shin D14/138 G
D881,831 S * 4/2020 Song D14/138 G
D890,113 S * 7/2020 Ma D14/138 G
D890,712 S * 7/2020 Liu D14/138 G
D891,386 S * 7/2020 Liu D14/138 G

(56) **References Cited**

U.S. PATENT DOCUMENTS

D712,368 S * 9/2014 Hibi D14/138 G
D713,373 S * 9/2014 Hibi D14/138 G
D730,859 S * 6/2015 Kaneta D14/138 G
D730,863 S * 6/2015 Yamagishi D14/138 G
D742,347 S * 11/2015 Kim D14/138 G
D746,245 S * 12/2015 Ryu D14/138 G
D750,588 S * 3/2016 Kim D14/138 G
D767,522 S * 9/2016 Wu D14/138 G
D775,600 S * 1/2017 Kim D14/138 G
D781,804 S * 3/2017 Park D14/138 G
D783,565 S * 4/2017 Kim D14/138 G
D787,467 S * 5/2017 Xu D14/138 C
D788,728 S * 6/2017 Kim D14/138 AA

OTHER PUBLICATIONS

Samsung Galaxy Note10 5G, announced Aug. 2019, [online],
[retrieved on Apr. 21, 2021]. Retrieved from Internet ,<URL:
<http://www.gsmarena.com>>.*
Samsung Galaxy Note10+ 5G, announced Aug. 2019, [online],
[retrieved on Apr. 21, 21]. Retrieved from Internet ,<URL: <http://www.gsmarena.com>>.*
Samsung Galaxy Note9, announced Aug. 9, 2018, [online], [retrieved
on Apr. 21, 2021]. Retrieved from Internet ,<URL: <http://www.gsmarena.com>>.*

* cited by examiner

FIG. 1

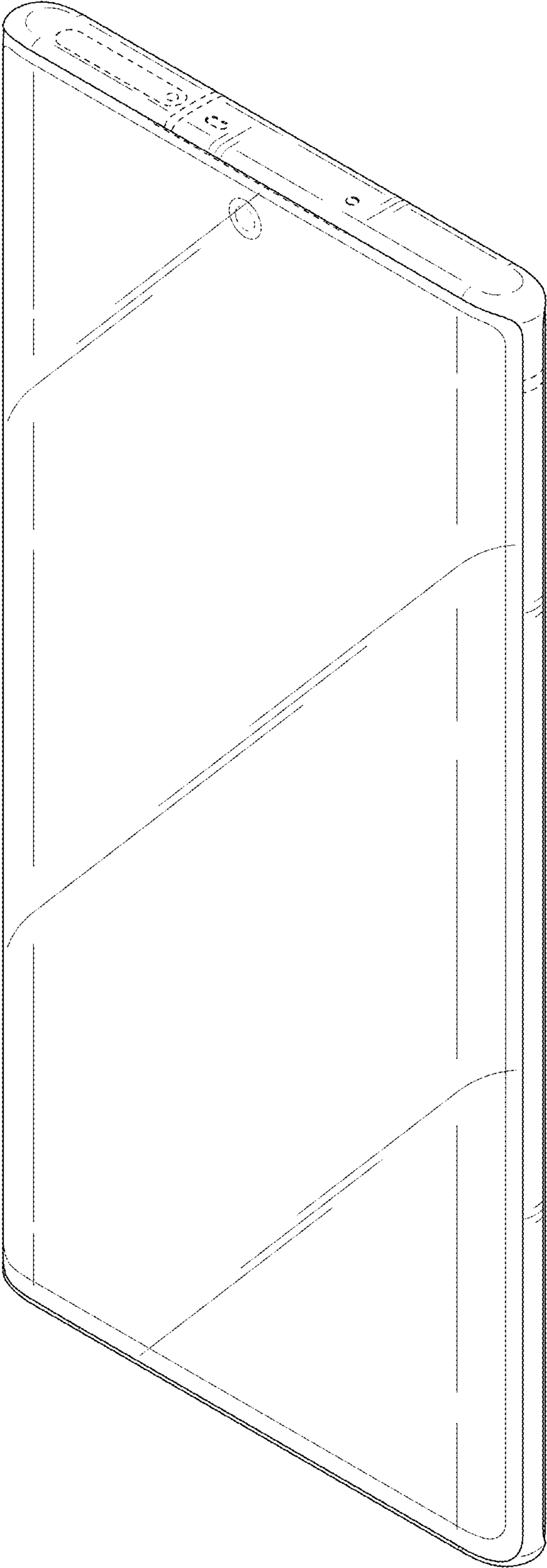

FIG. 2

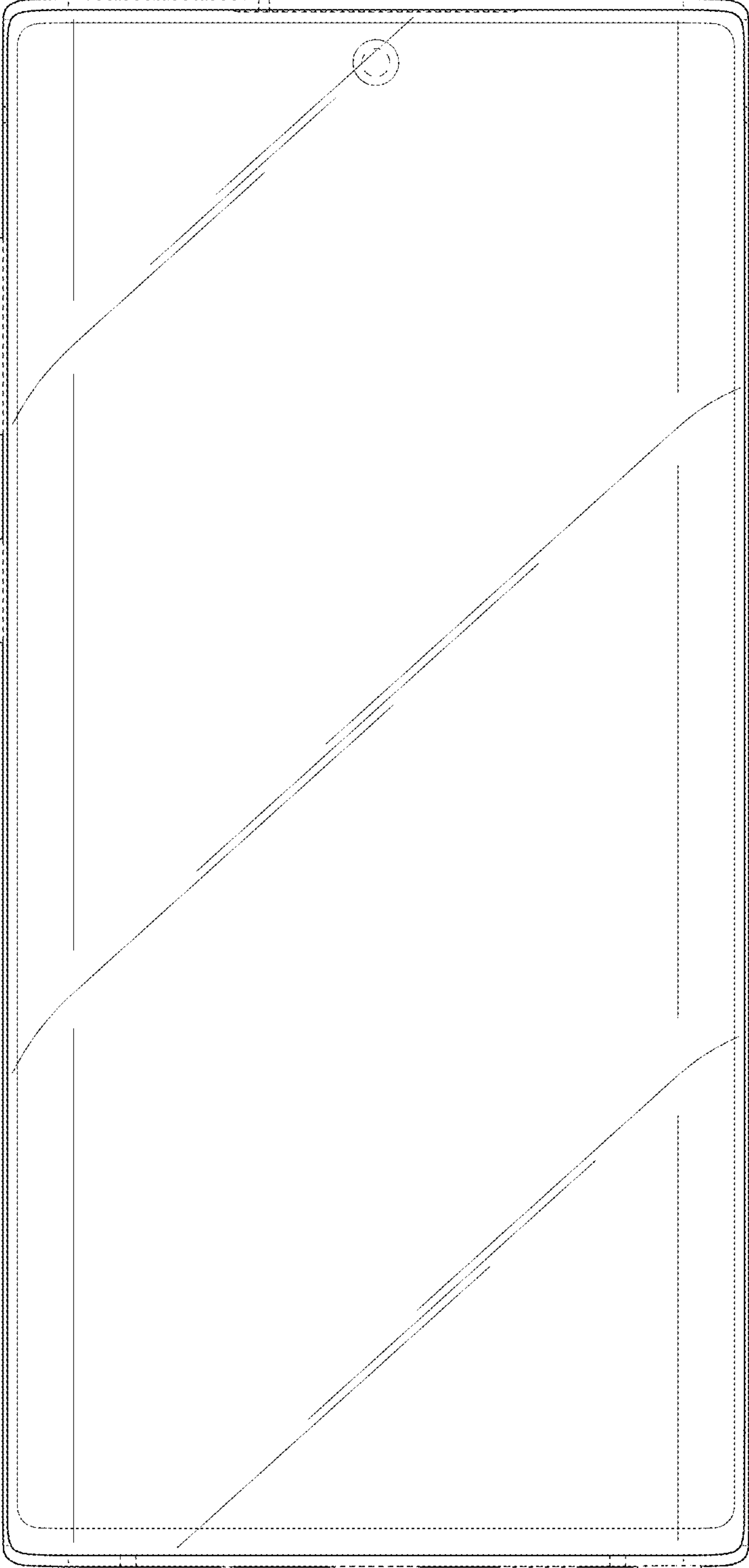

FIG. 3

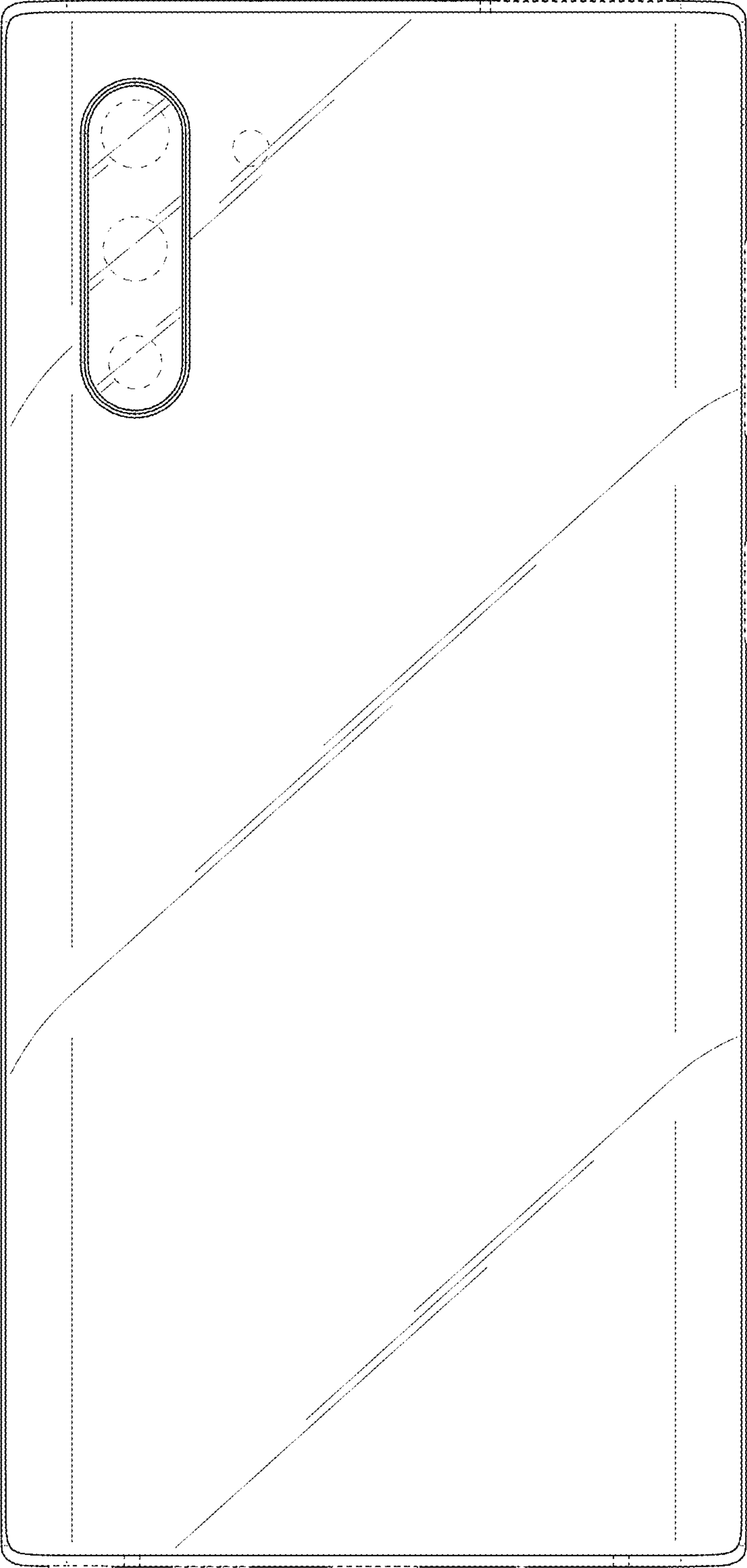

FIG. 4



FIG. 5



FIG. 6

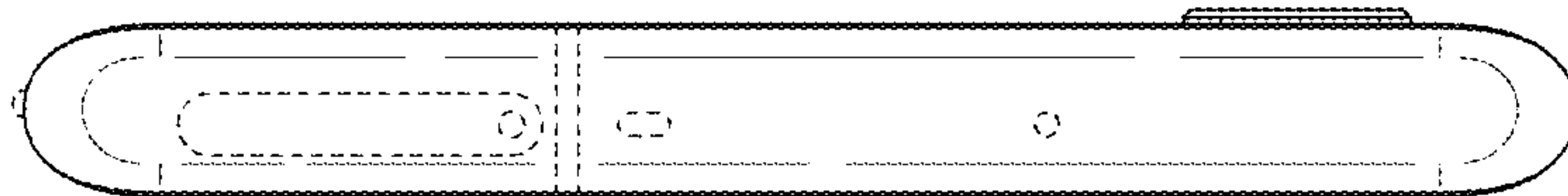

FIG. 7

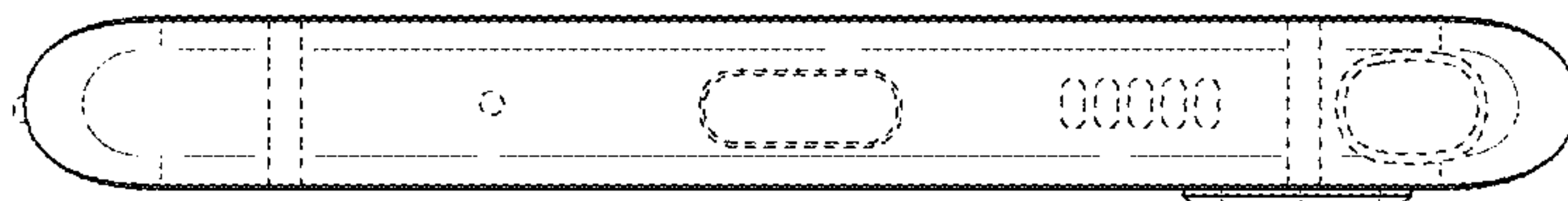

FIG. 8

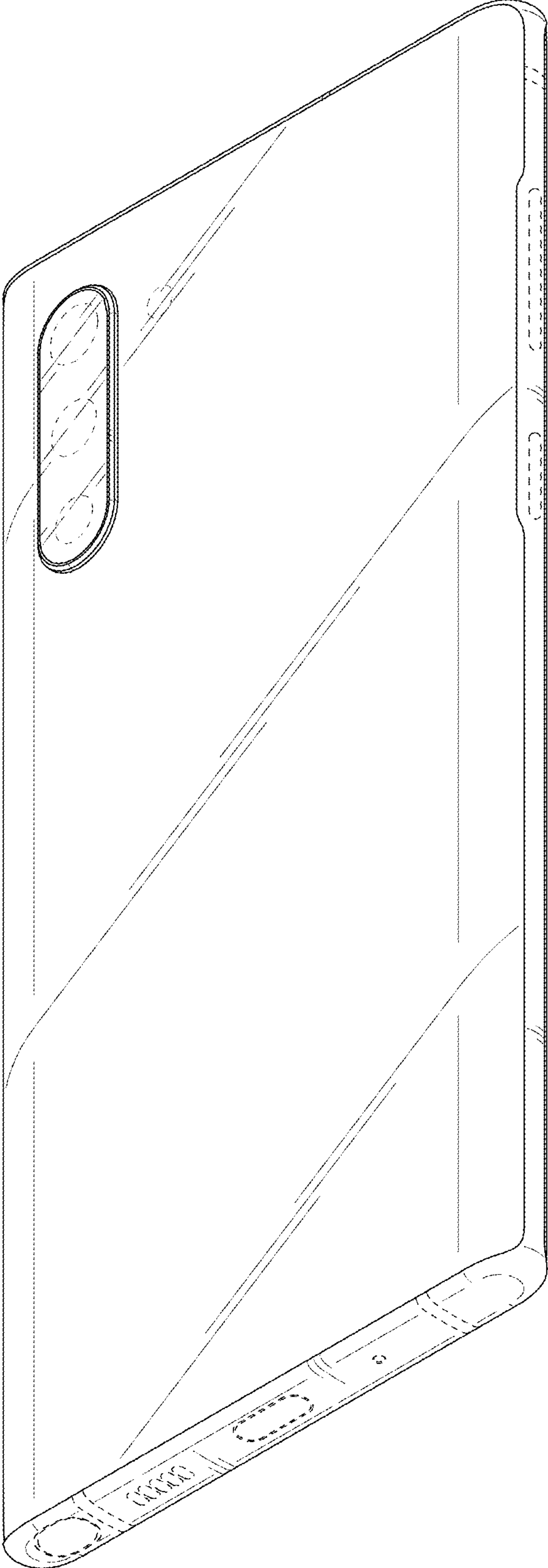

FIG. 9

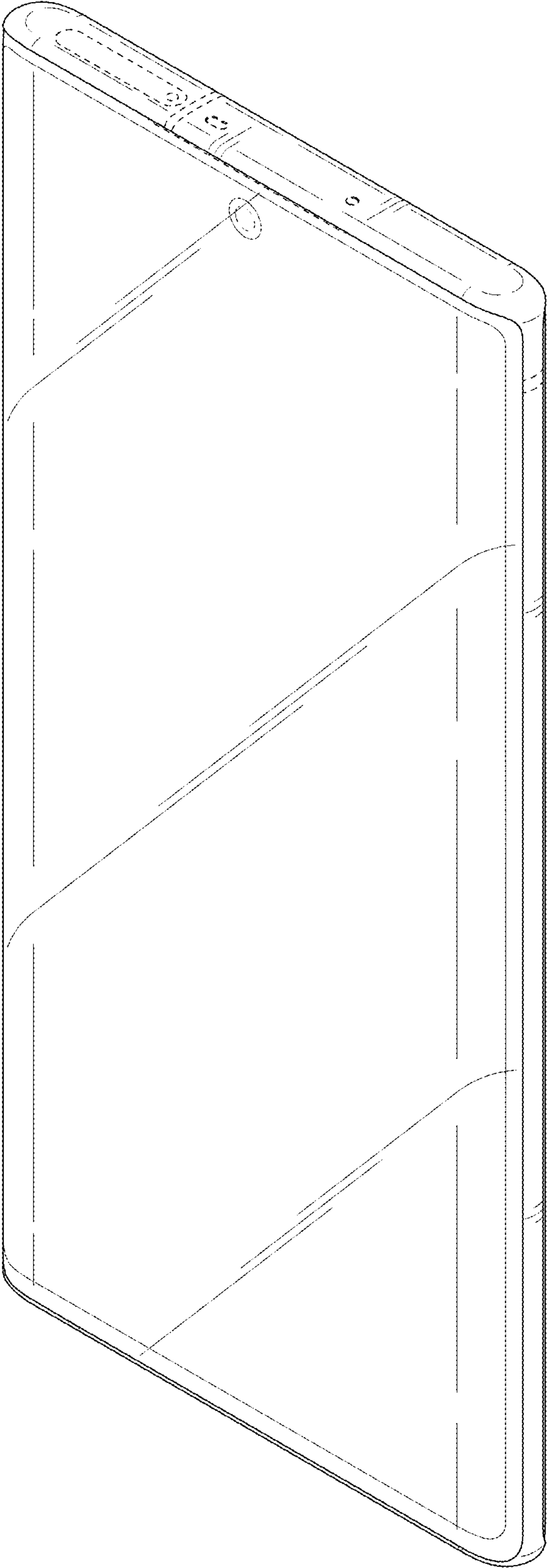

FIG. 10

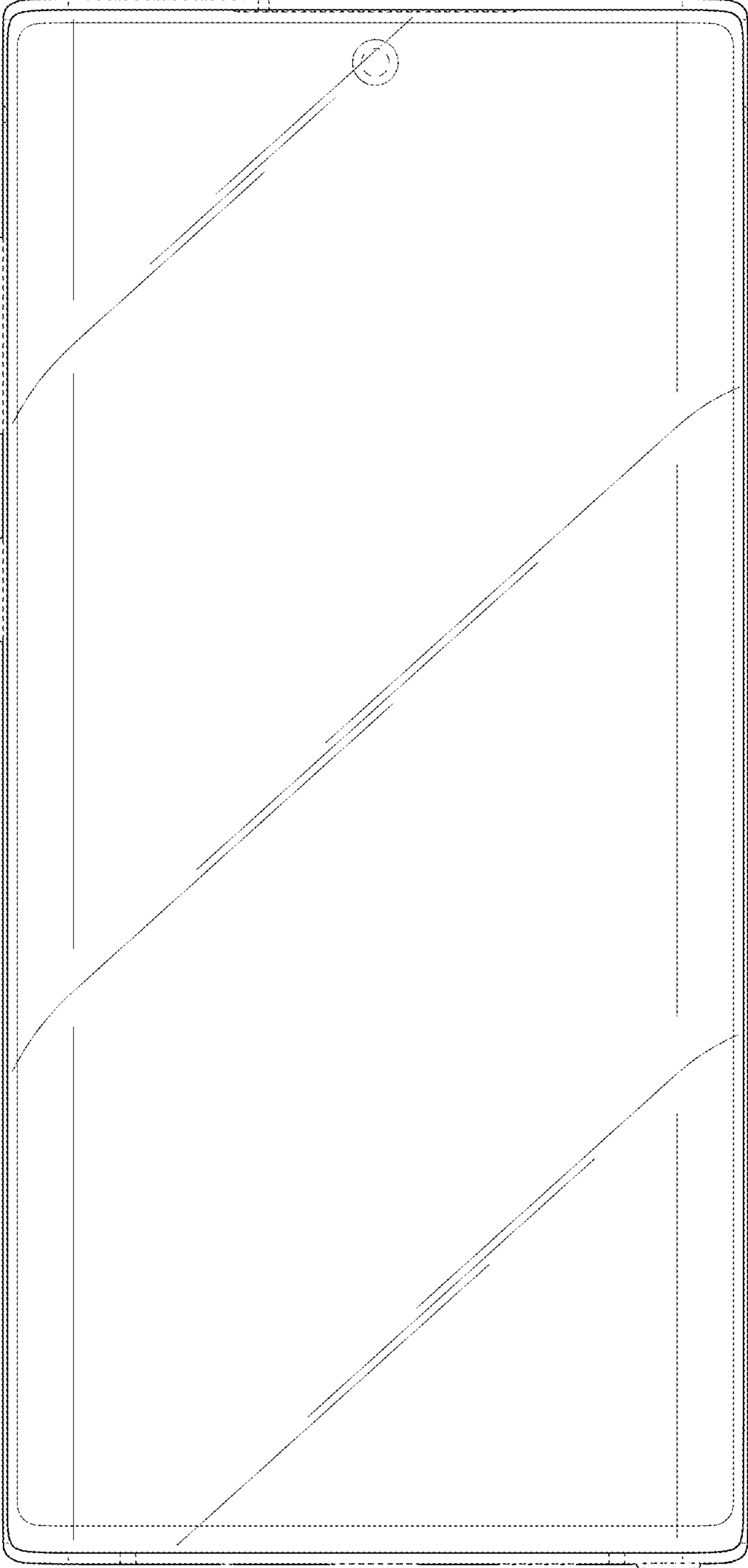

FIG. 11

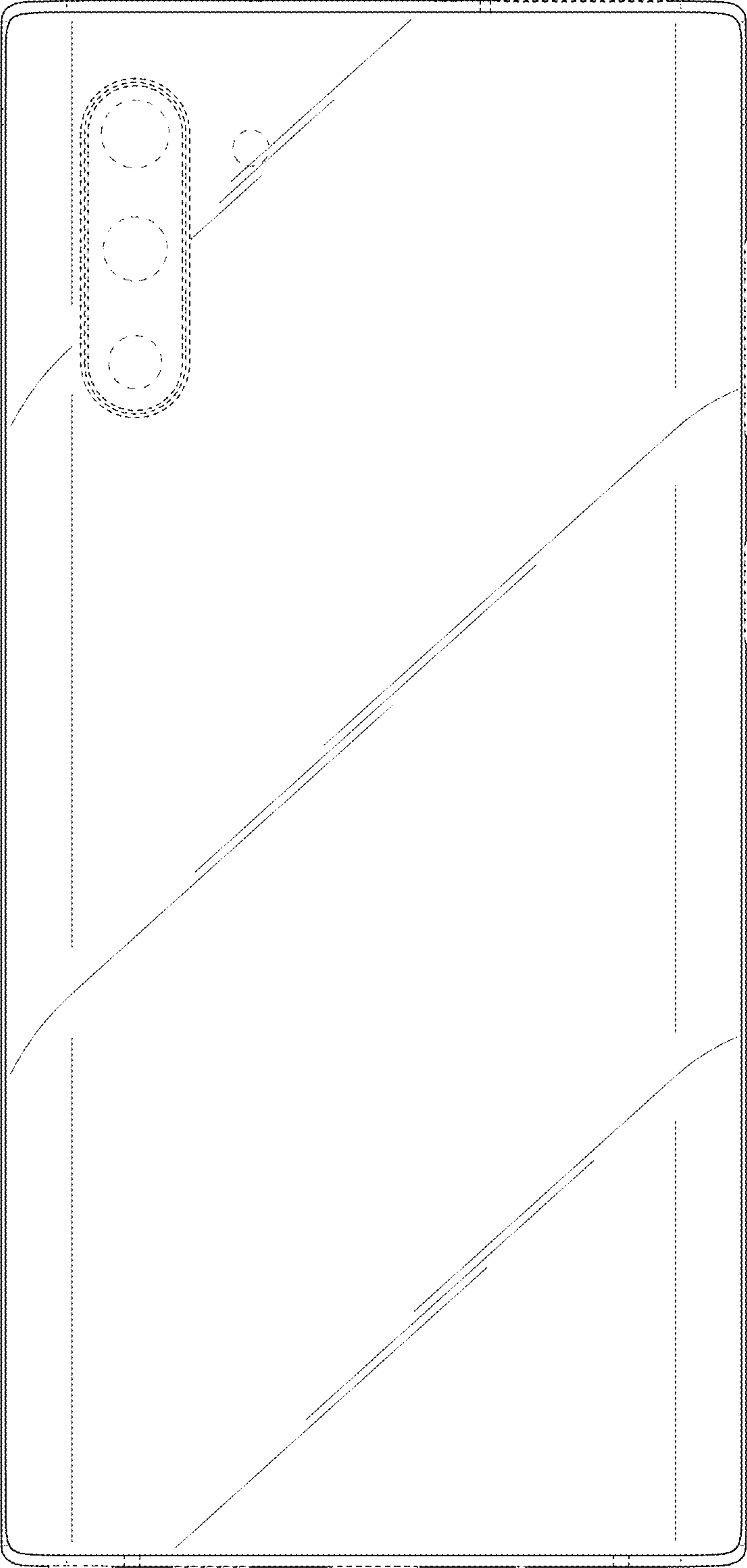

FIG. 12



FIG. 13

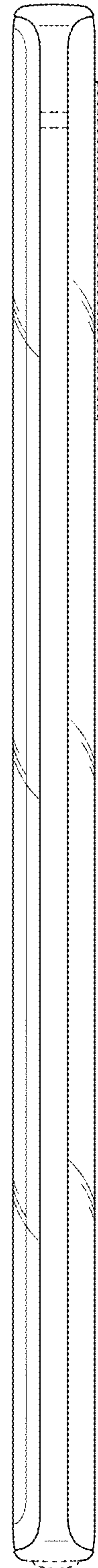

FIG. 14

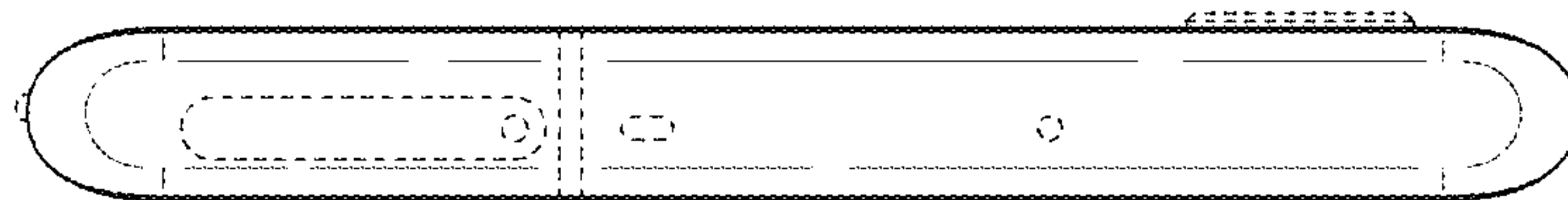

FIG. 15

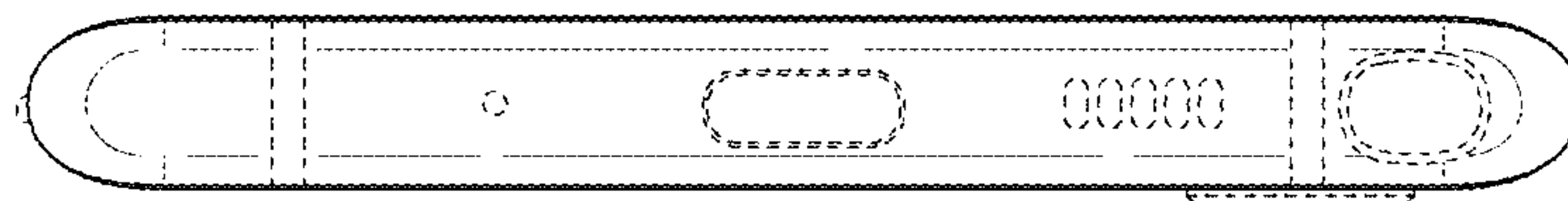

FIG. 16

