



US00D924011S

(12) **United States Design Patent** (10) **Patent No.:** **US D924,011 S**  
**Dag** (45) **Date of Patent:** **\*\* Jul. 6, 2021**

(54) **TUMBLER**

(71) Applicant: **PAPACKS SALES GmbH**, Cologne (DE)

(72) Inventor: **Tahsin Dag**, Cologne (DE)

(\*\*) Term: **15 Years**

(21) Appl. No.: **35/509,314**

(22) Filed: **Nov. 8, 2019**

(80) **Hague Agreement Data**

Int. Filing Date: **Nov. 8, 2019**

Int. Reg. No.: **DM/204678**

Int. Reg. Date: **Nov. 8, 2019**

Int. Reg. Pub. Date: **May 8, 2020**

(51) **LOC (13) Cl.** ..... **07-01**

(52) **U.S. Cl.**  
USPC ..... **D7/523**

(58) **Field of Classification Search**  
USPC ..... D7/396.2, 500, 509-511, 523, 524,  
D7/537-538, 526-528, 530-533, 540,  
D7/565, 584, 900, 622

See application file for complete search history.

(56) **References Cited**

U.S. PATENT DOCUMENTS

|                 |        |         |       |           |
|-----------------|--------|---------|-------|-----------|
| D7,241 S *      | 3/1874 | McKee   | ..... | D7/531    |
| D272,116 S *    | 1/1984 | Durand  | ..... | D7/523    |
| D308,318 S *    | 6/1990 | Durand  | ..... | D7/509    |
| D370,830 S *    | 6/1996 | Wilson  | ..... | D7/523    |
| D561,535 S *    | 2/2008 | Jin     | ..... | D7/509    |
| D852,583 S *    | 7/2019 | Tomalia | ..... | D7/523    |
| D889,203 S *    | 7/2020 | Bull    | ..... | D7/523    |
| 10,974,861 B2 * | 4/2021 | Liming  | ..... | B65D 1/44 |

\* cited by examiner

*Primary Examiner* — Michael A. Pratt

(57) **CLAIM**

The ornamental design for a tumbler, as shown and described.

**DESCRIPTION**

- 1. Tumbler
- 1.1 : Perspective
- 1.2 : Front
- 1.3 : Bottom
- 1.4 : Top
- 1.5 : Right side view
- 1.6 : Rear view
- 1.7 : Left side view

**1 Claim, 7 Drawing Sheets**

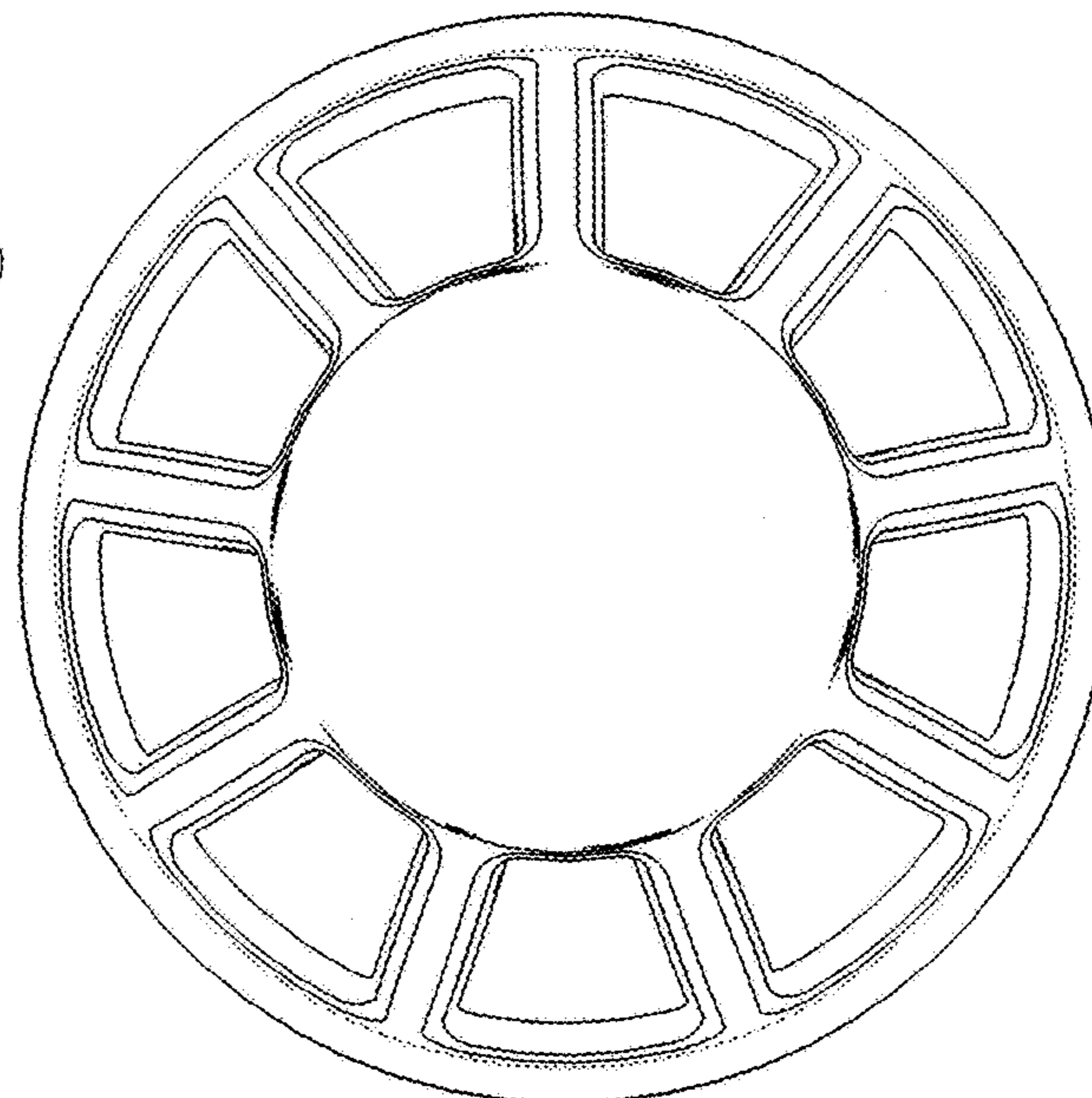
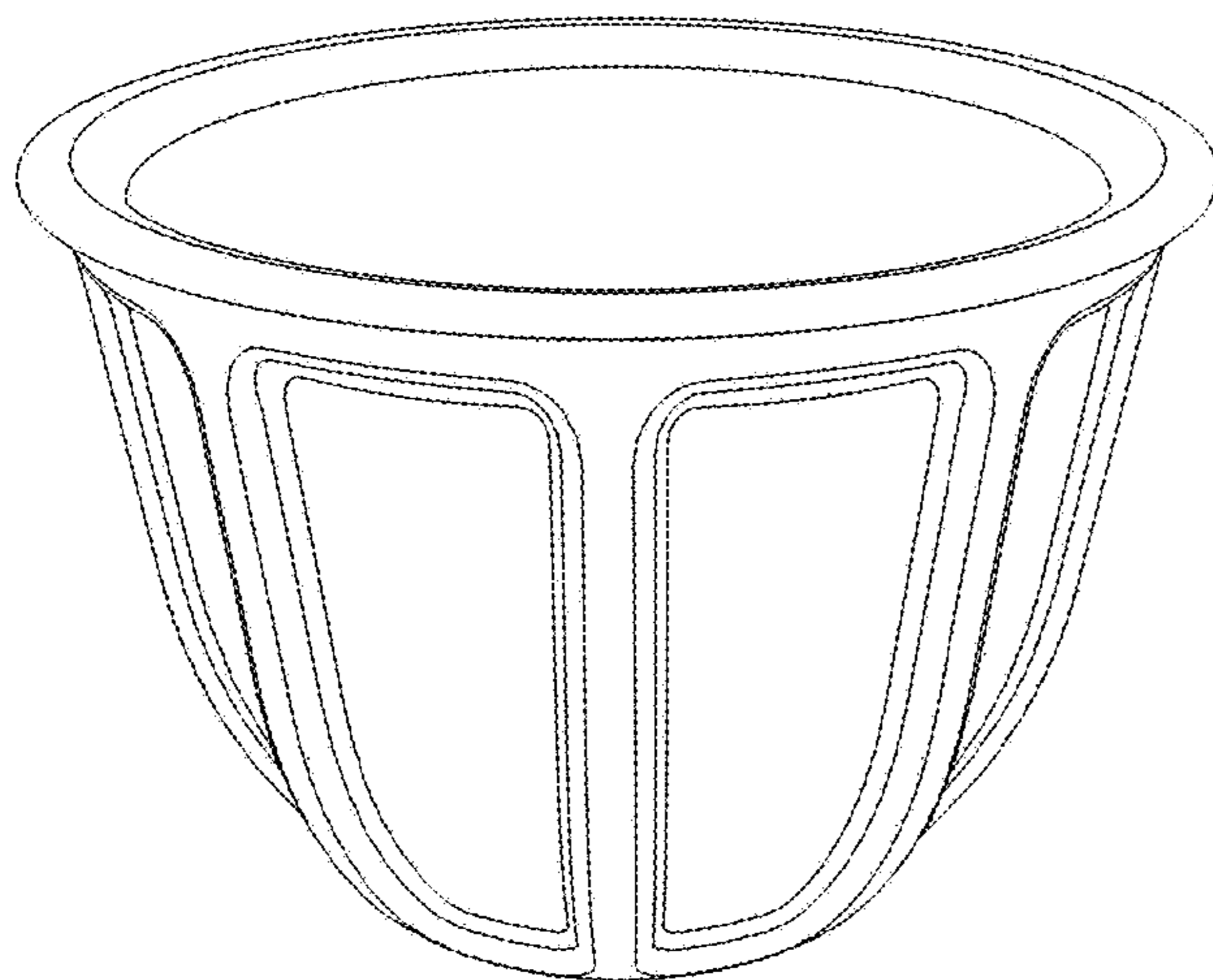

1.1

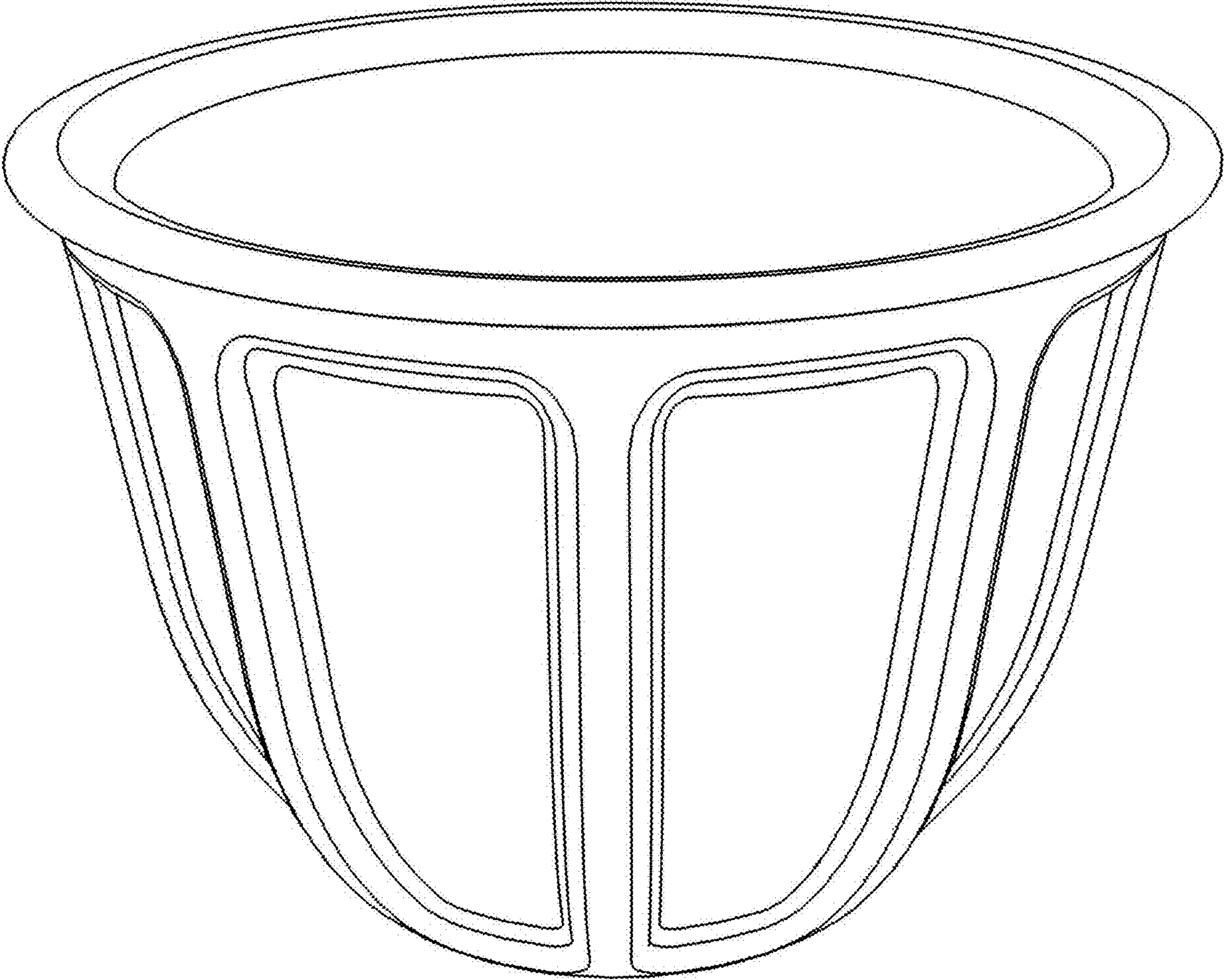

1.2

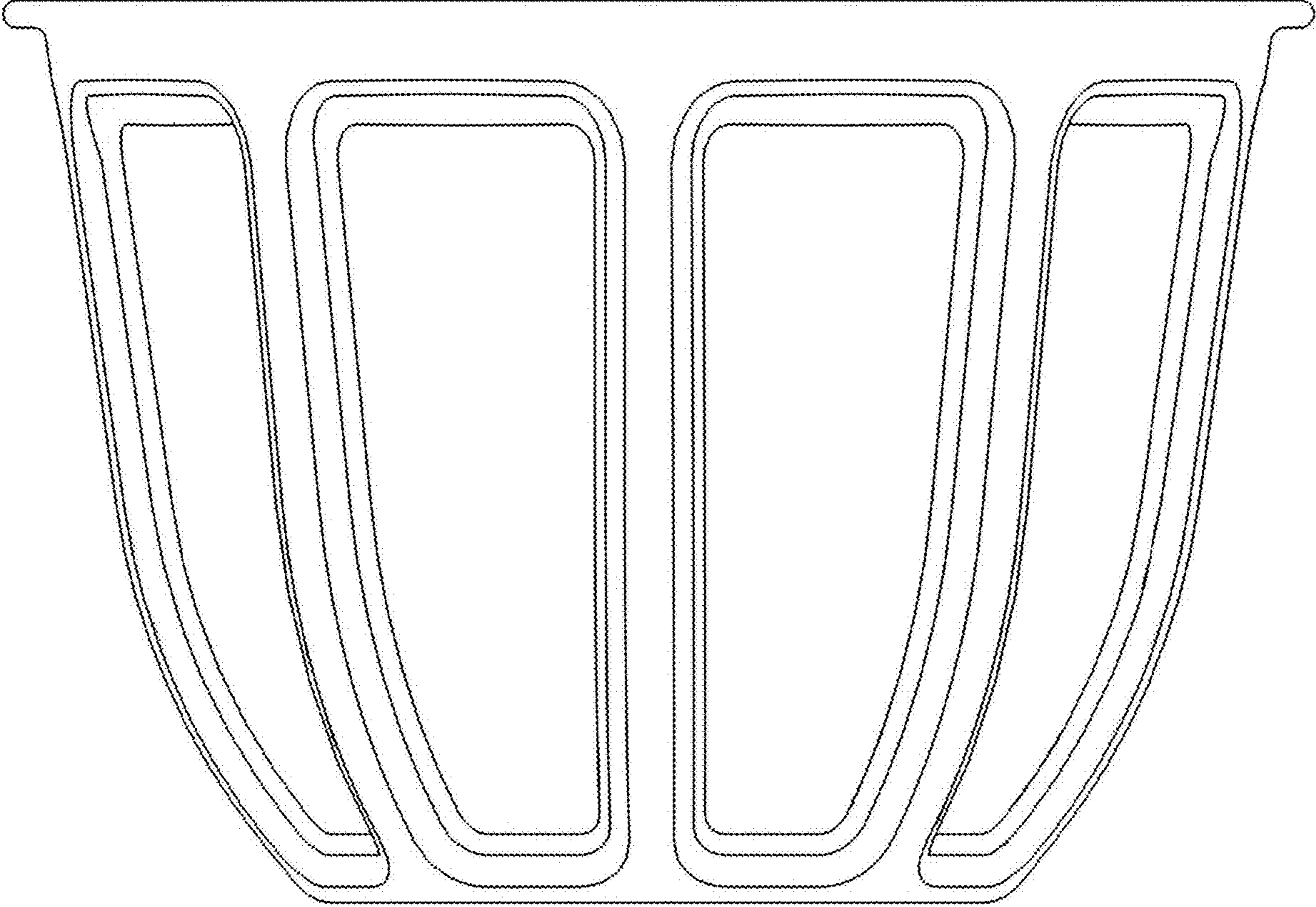



1.3

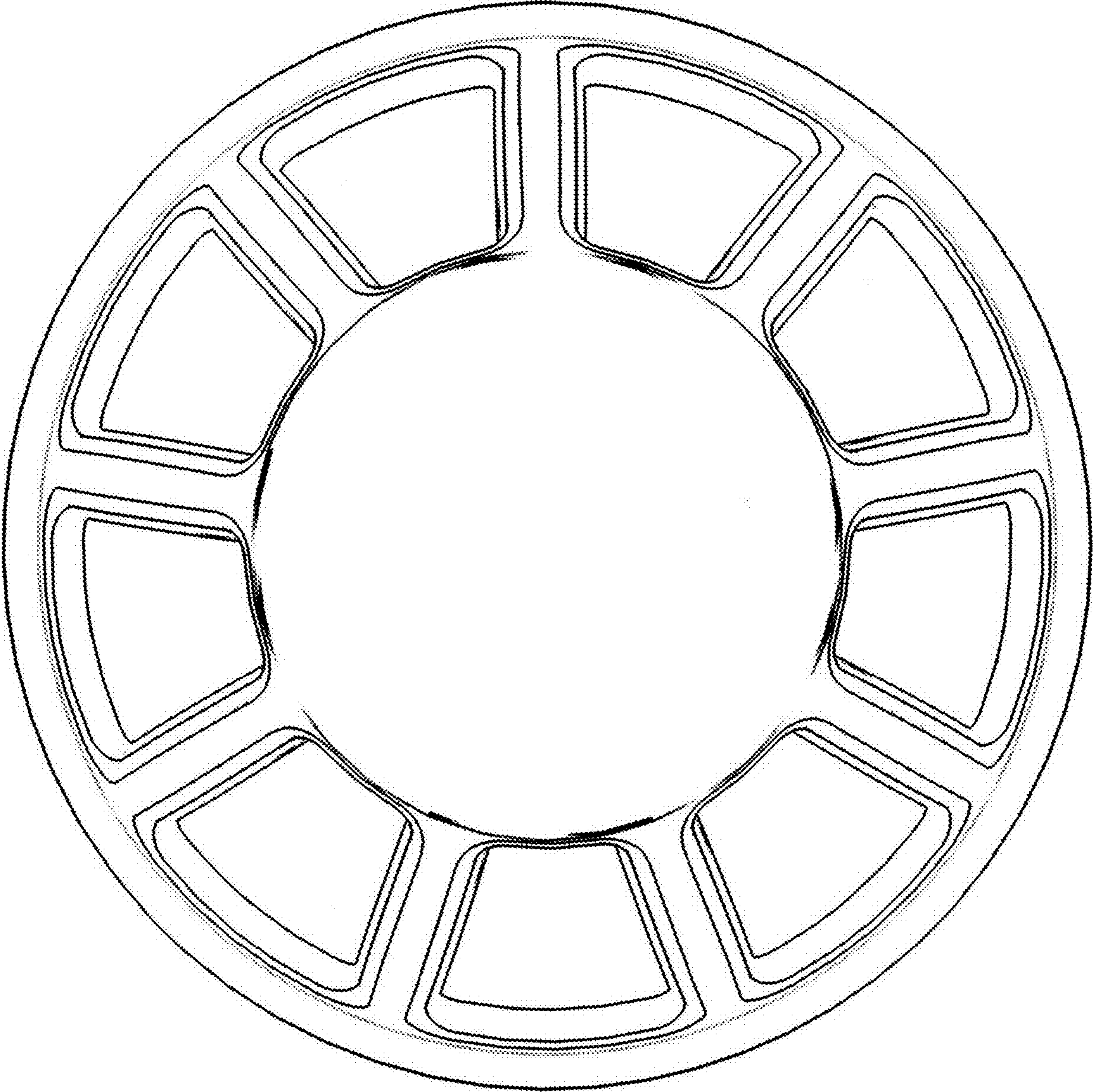

1.4

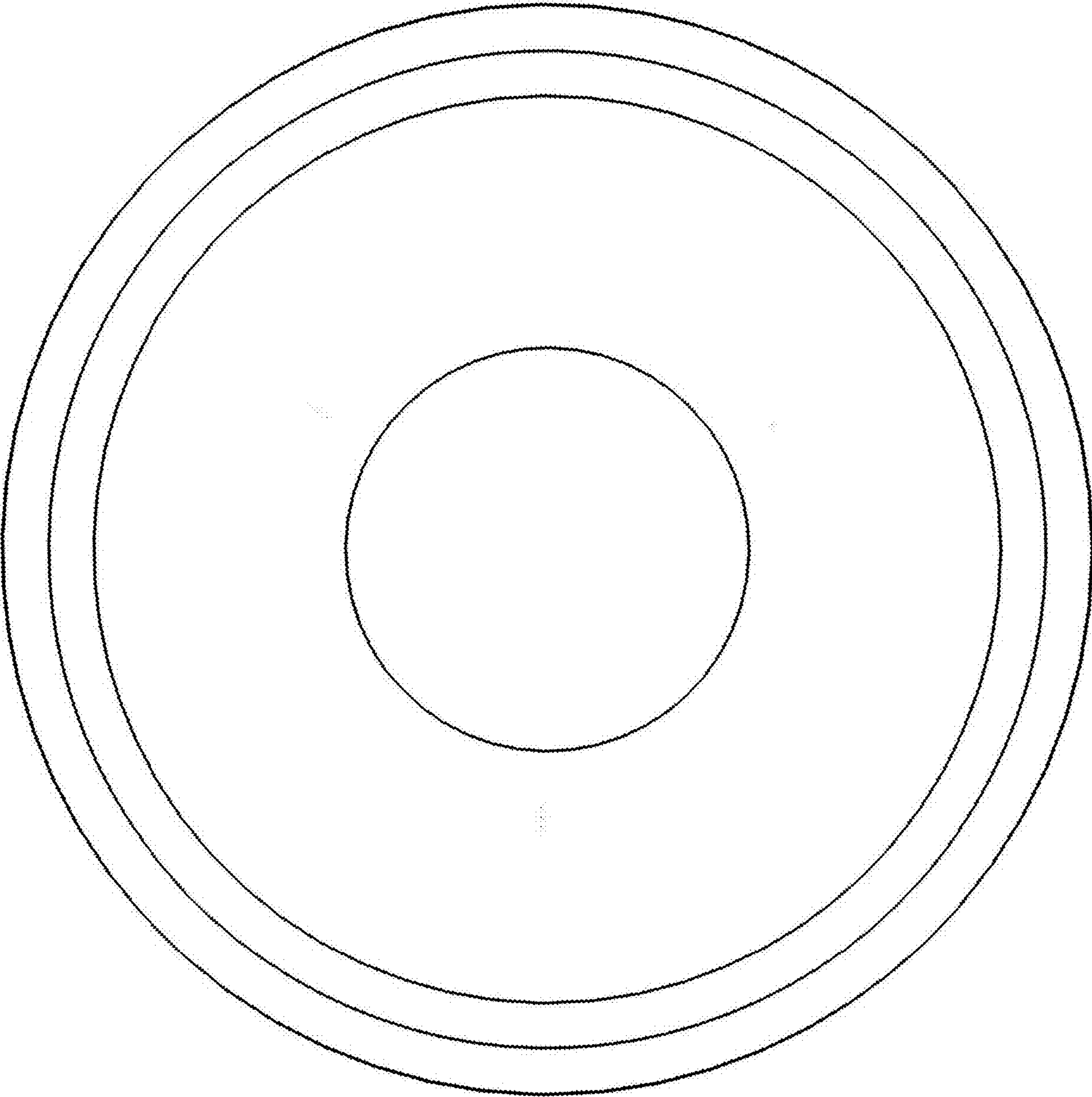

1.5

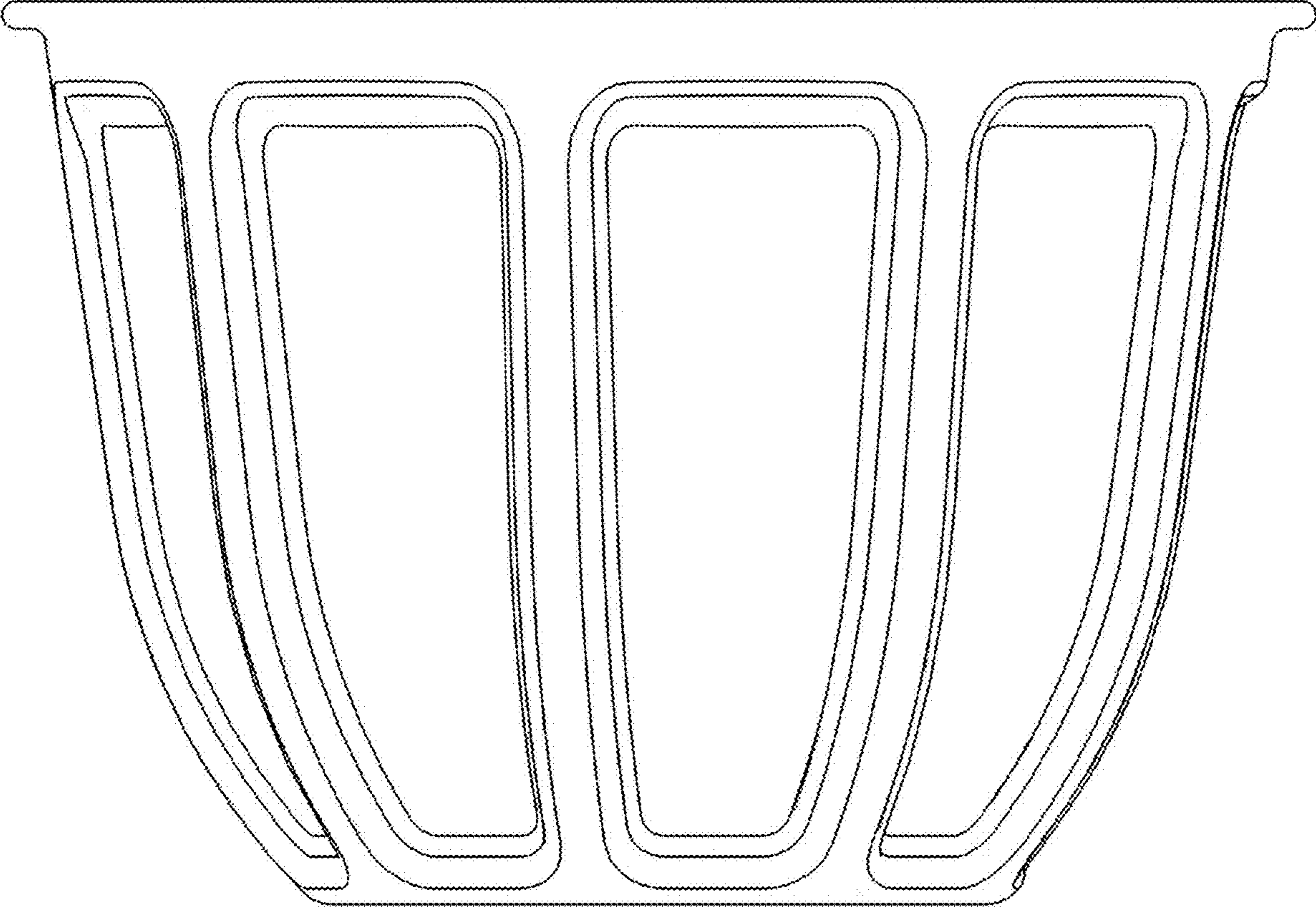



1.6

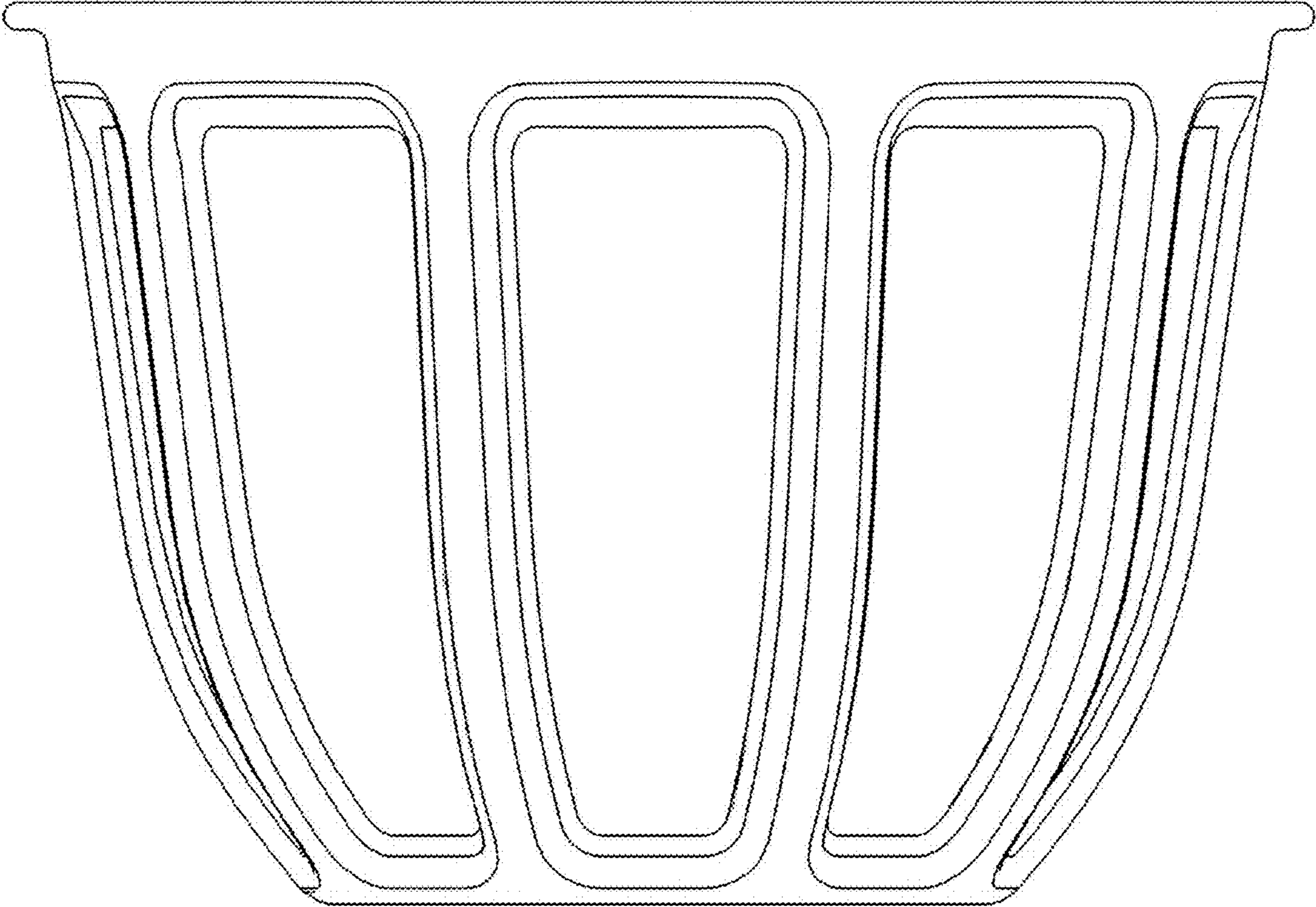

1.7

