



US00D923988S

(12) **United States Design Patent** (10) **Patent No.:** **US D923,988 S**
Shyu (45) **Date of Patent:** **** Jul. 6, 2021**

(54) **TABLE FRAME ASSEMBLY**

(71) Applicant: **EP Family Corp.**, Walnut, CA (US)

(72) Inventor: **Chin-Hung Shyu**, Chiayi (TW)

(**) Term: **15 Years**

(21) Appl. No.: **29/680,469**

(22) Filed: **Feb. 15, 2019**

(51) **LOC (13) Cl.** **06-06**

(52) **U.S. Cl.**
 USPC **D6/702**

(58) **Field of Classification Search**
 USPC D6/702, 708, 709, 709.21; D8/16, 354,
 D8/382, 396
 CPC A47B 13/003; A47B 13/06; A47B 91/00;
 A47B 91/005; A47B 91/02; A47B 95/00;
 A47B 2220/00; A47B 2230/00; A47B
 2230/04; A47B 2230/14; F16B 12/10;
 F16B 12/20; F16M 13/02
 See application file for complete search history.

(56) **References Cited**

U.S. PATENT DOCUMENTS

4,417,539 A * 11/1983 Thompson F16M 13/02
 114/218
 4,630,550 A * 12/1986 Weitzman A47B 13/06
 108/155
 4,878,777 A * 11/1989 Debus A47B 91/005
 403/205
 D599,193 S * 9/2009 Meyer D8/354
 D678,045 S * 3/2013 Paolini F16M 13/02
 D8/382
 D732,912 S * 6/2015 Cavaliere F16B 5/0032
 D8/16
 D823,675 S * 7/2018 Dammann D8/380
 2016/0272027 A1 * 9/2016 Dilworth F16M 13/02
 2019/0072122 A1 * 3/2019 DeSmet F16B 5/0032

2020/0240179 A1* 7/2020 Grewe E05B 65/106
 * cited by examiner

Primary Examiner — Mary Ann Calabrese
 (74) *Attorney, Agent, or Firm* — Tommy SF Wang; Wang
 IP Law Group, P.C.

(57) **CLAIM**
 The ornamental design for a table frame assembly, as shown
 and described.

DESCRIPTION

FIG. 1 is a perspective view of a rod component for a table
 frame assembly showing my new design, separately for
 clarity of disclosure;
 FIG. 2 is a front view thereof;
 FIG. 3 is a rear view thereof;
 FIG. 4 is a left side view thereof;
 FIG. 5 is a right side view thereof;
 FIG. 6 is a top view thereof;
 FIG. 7 is a bottom view thereof;
 FIG. 8 is a perspective view of a stand component for the
 table frame assembly showing my new design, separately
 for clarity of disclosure;
 FIG. 9 is a front view thereof;
 FIG. 10 is a rear view thereof;
 FIG. 11 is a left side view thereof;
 FIG. 12 is a right side view thereof;
 FIG. 13 is a top view thereof;
 FIG. 14 is a bottom view thereof;
 FIG. 15 is an exploded view showing a pair of stand
 components and a pair of rod components; and,
 FIG. 16 is a perspective view of the table frame assembly.
 The dashed broken lines on each of the components in FIGS.
 1-16 illustrate portions of the article that form no part of the
 claimed design. The dot-dash broken lines represent the
 boundaries of the claim and form no part thereof.

1 Claim, 11 Drawing Sheets

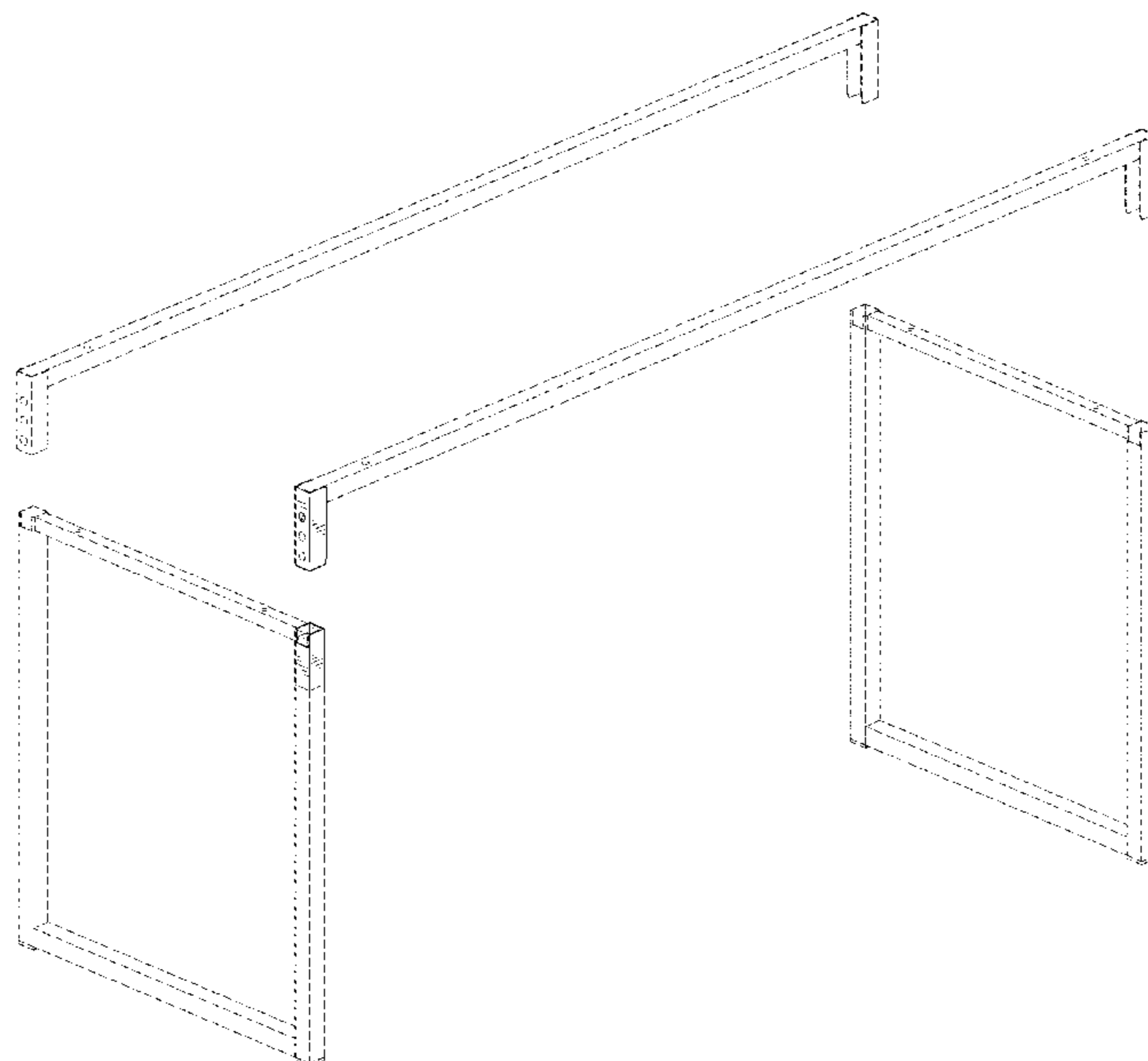

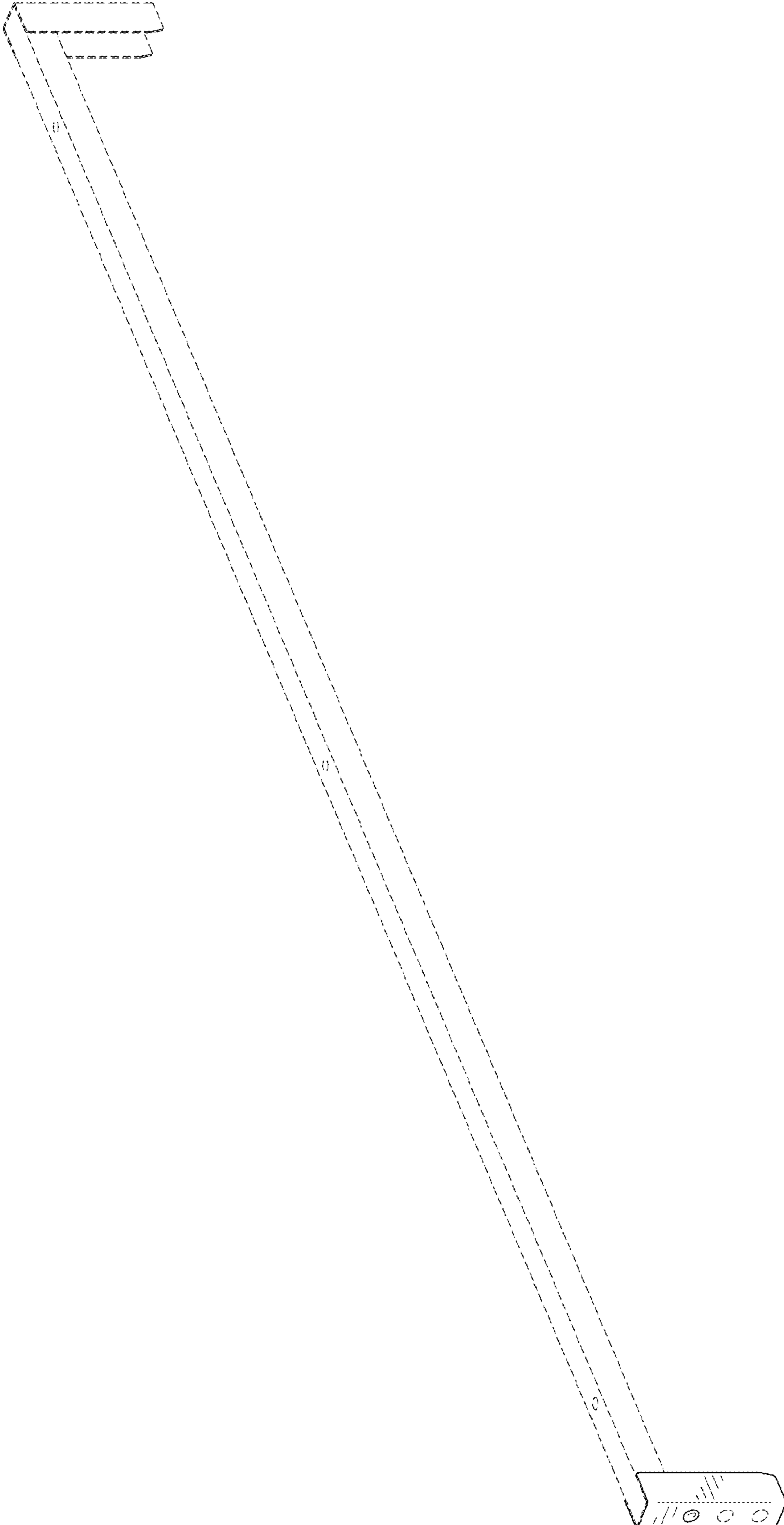

FIG. 1



FIG. 2

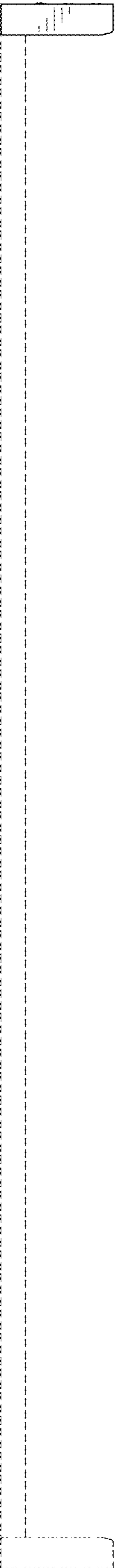

FIG. 3

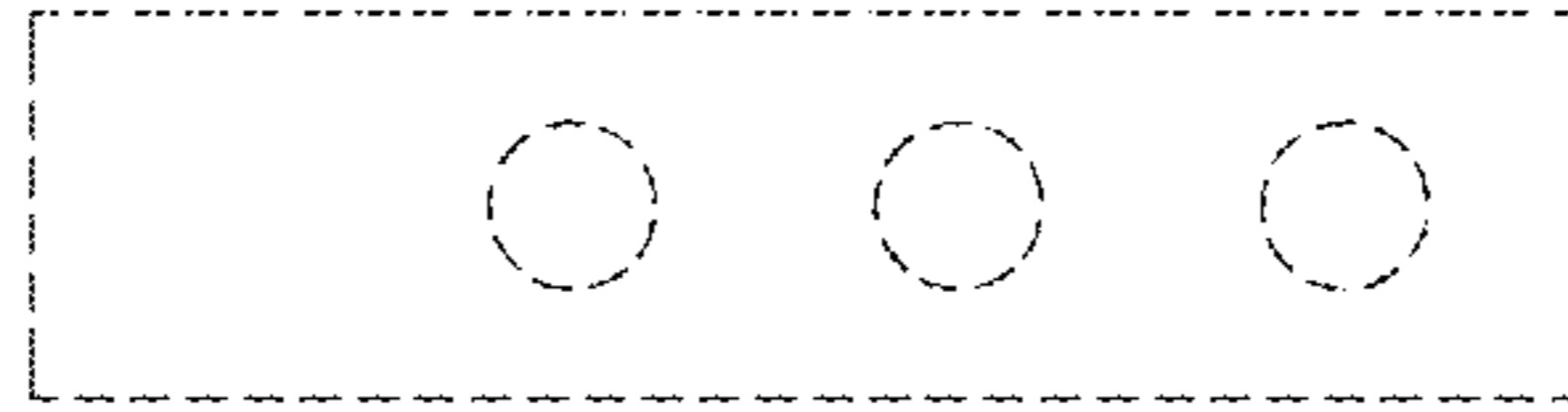

FIG. 5

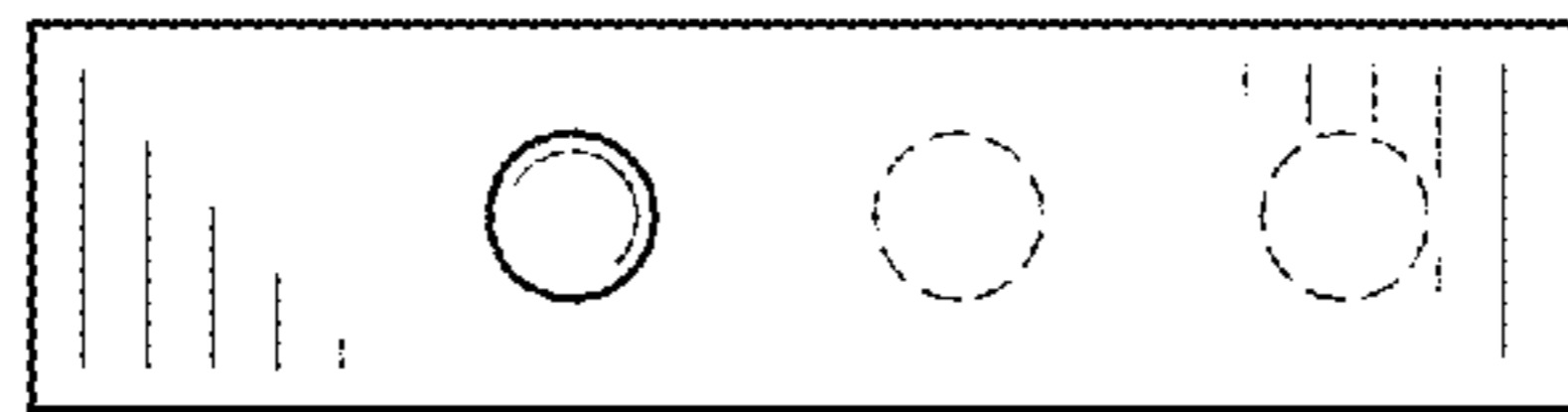

FIG. 4

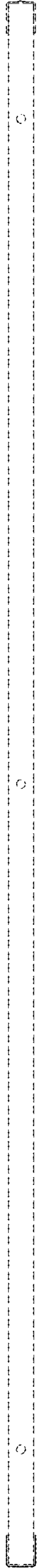

FIG. 6

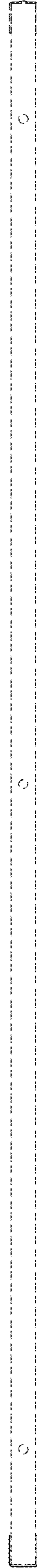

FIG. 7

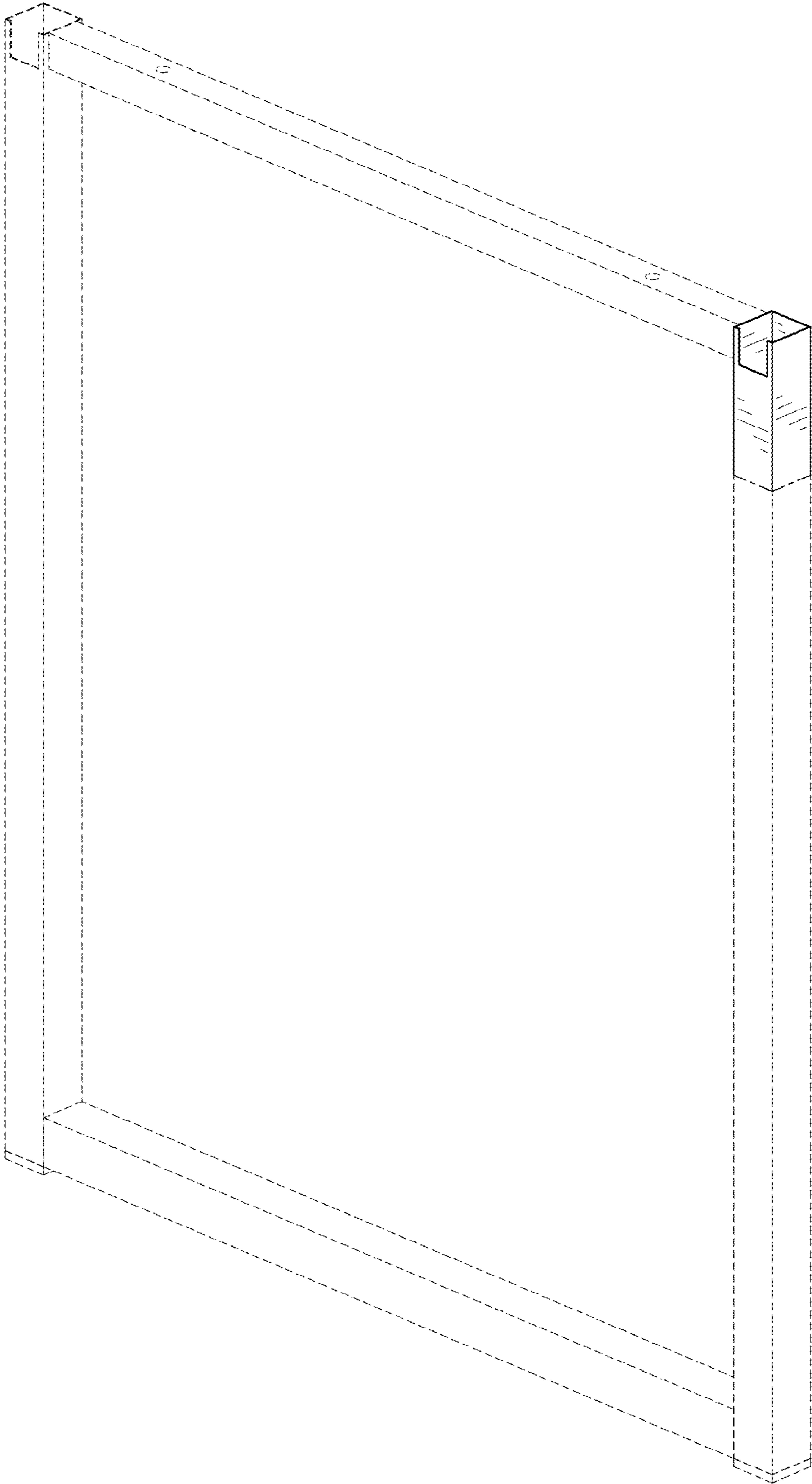

FIG. 8

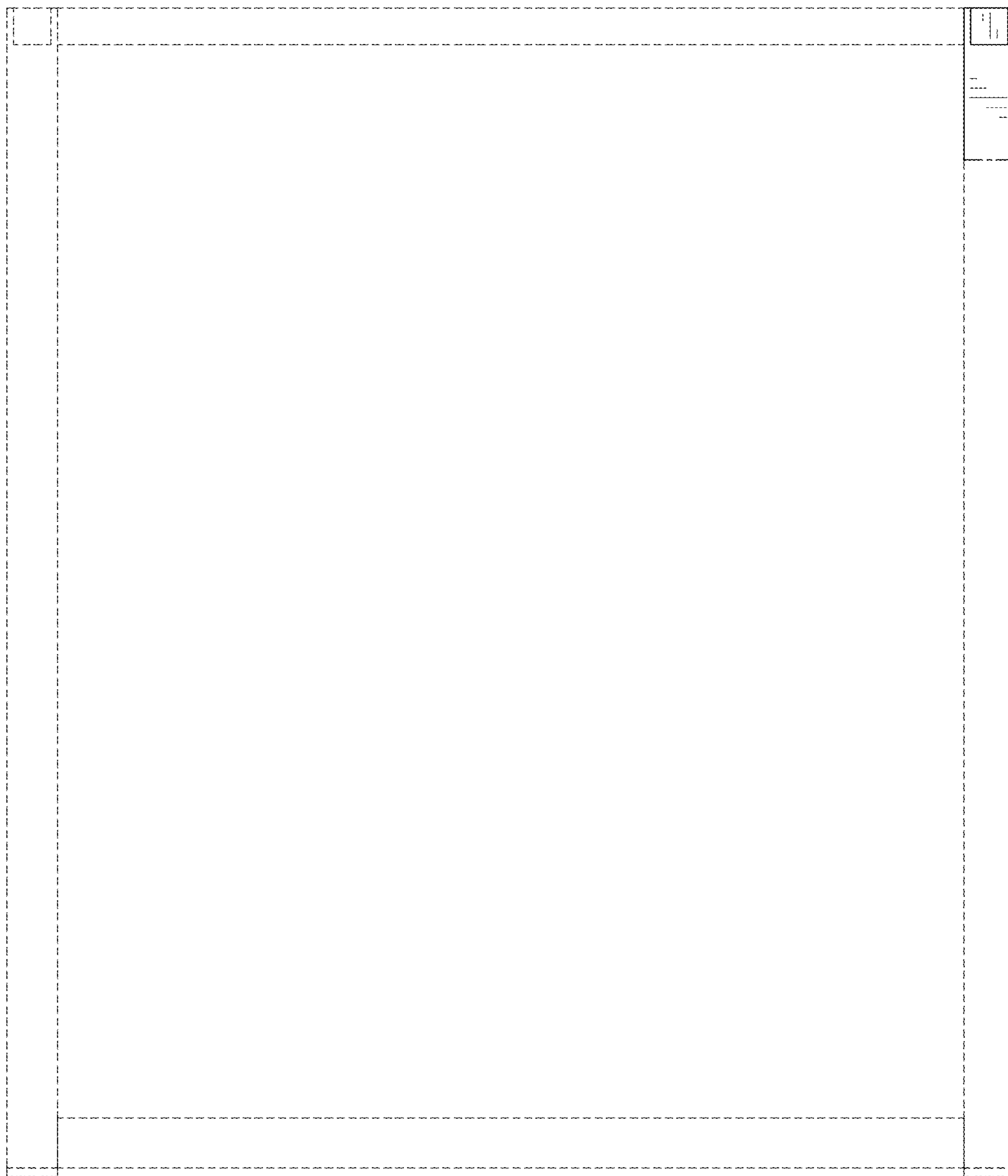

FIG. 9

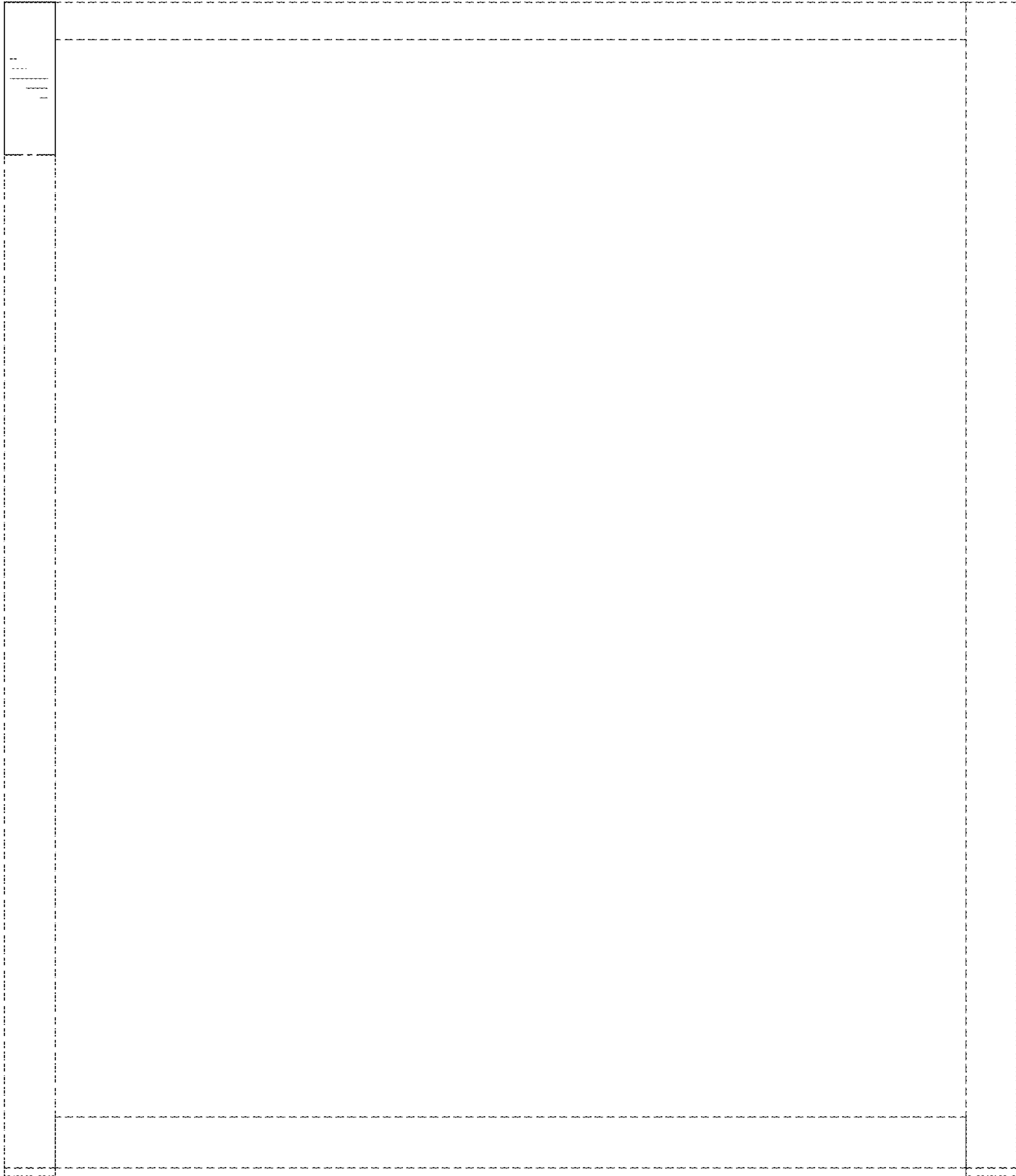

FIG. 10

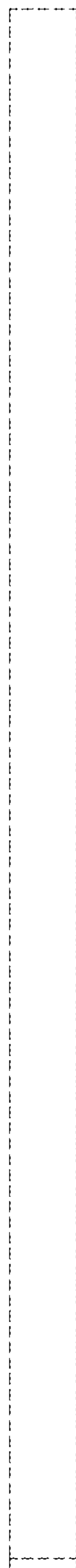

FIG. 11

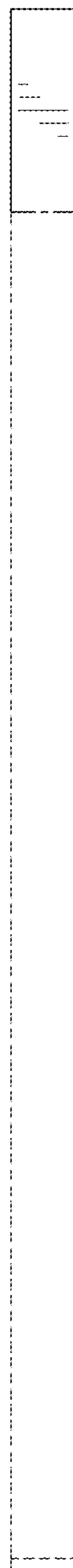

FIG. 12



FIG. 13

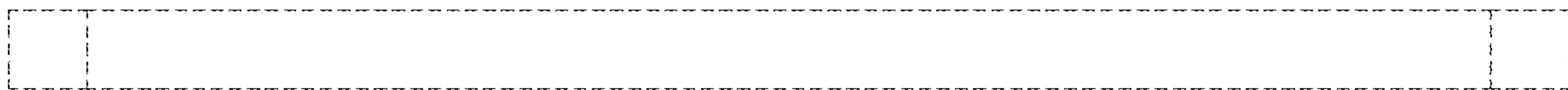

FIG. 14

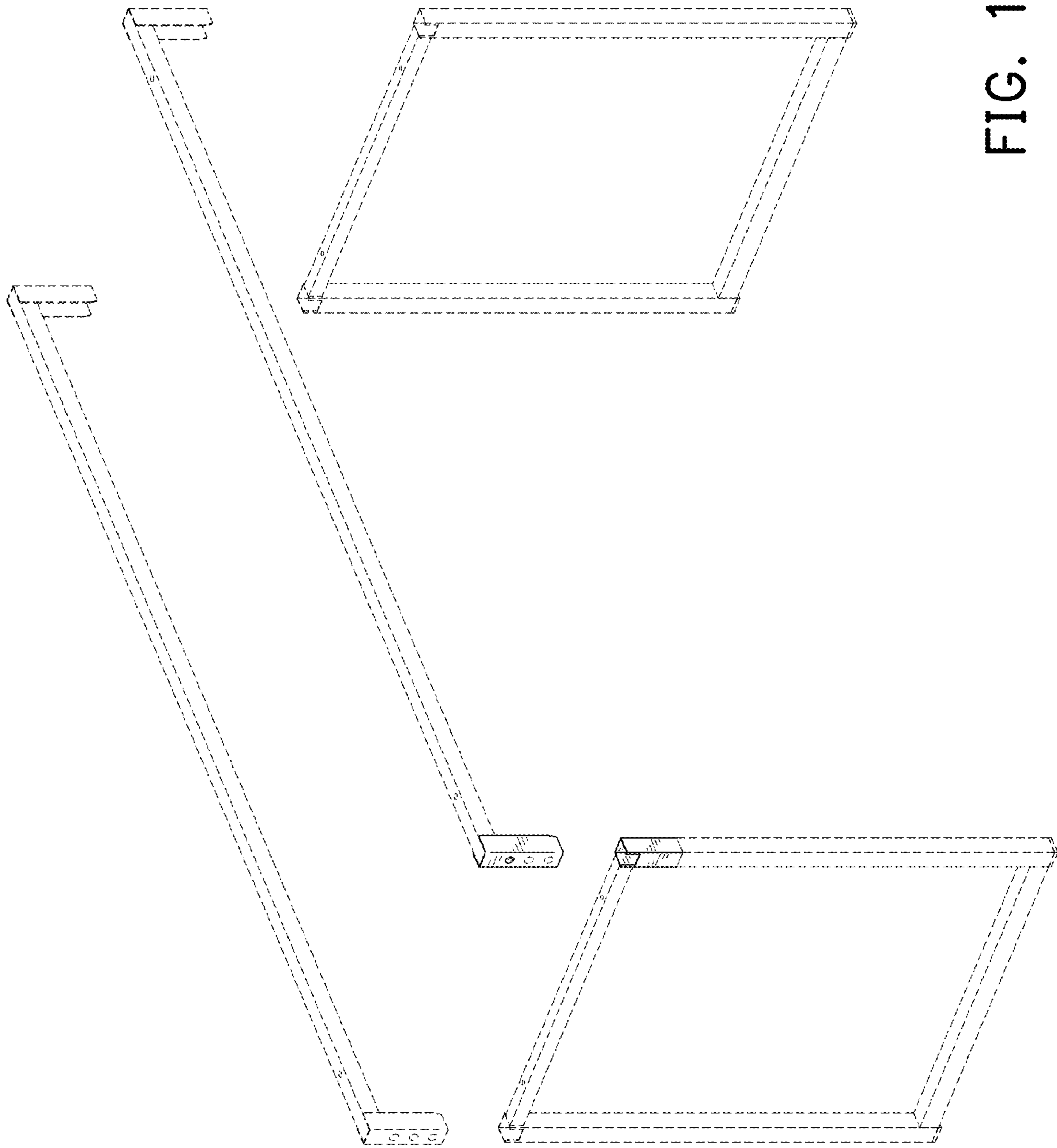

FIG. 15

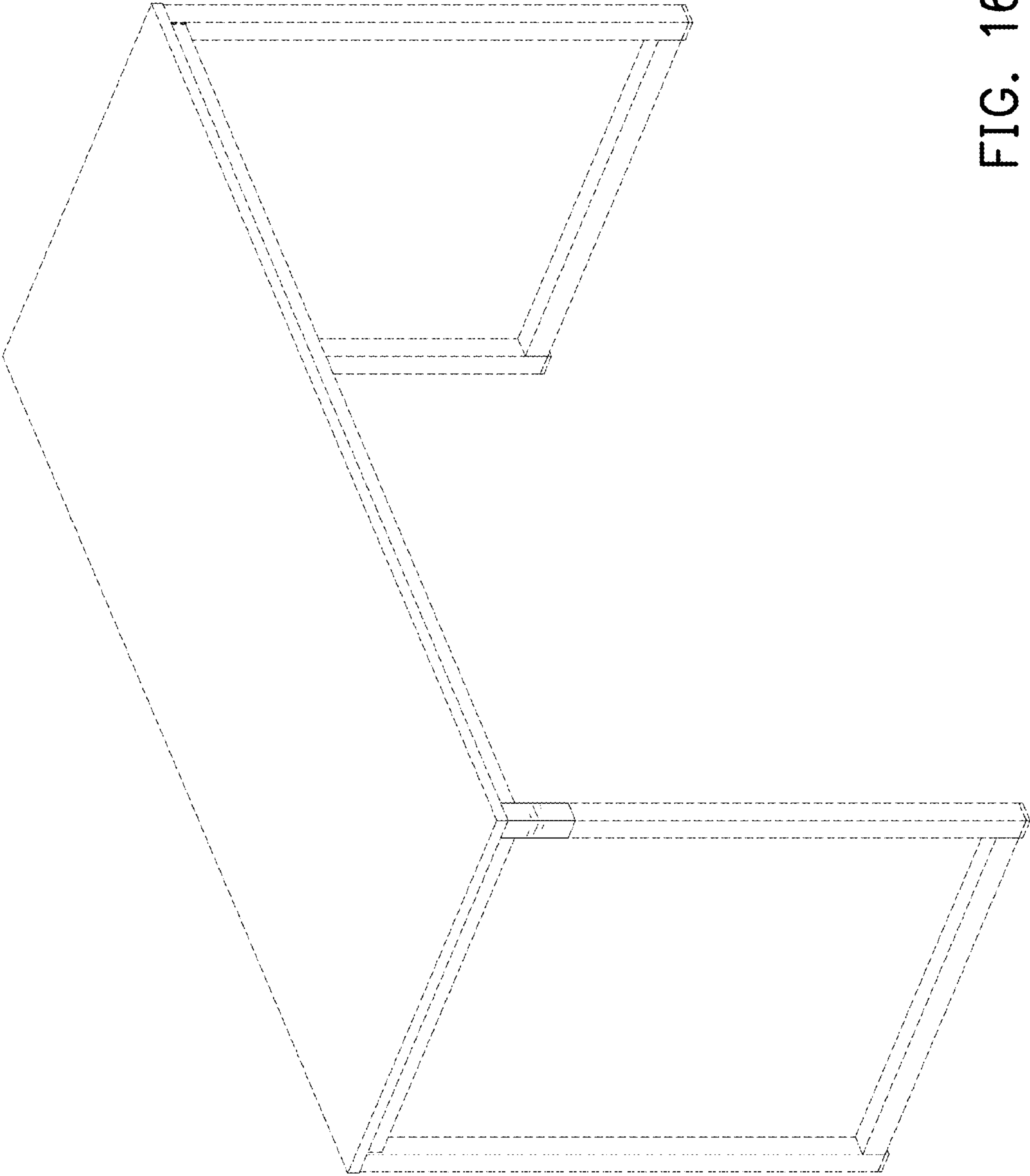

FIG. 16