



US00D923888S

(12) **United States Design Patent**
Liu

(10) **Patent No.:** **US D923,888 S**
(45) **Date of Patent:** **** Jun. 29, 2021**

(54) **HANDHELD VACUUM CLEANER**
(71) Applicant: **Shenzhen Yichangchuancheng Technology Co., Ltd., Shenzhen (CN)**

D879,395 S 3/2020 Pearce
D882,192 S 4/2020 Zhang
D897,617 S 9/2020 Chen
D898,311 S 10/2020 Smith
(Continued)

(72) Inventor: **Runbin Liu, Shenzhen (CN)**

(**) Term: **15 Years**

(21) Appl. No.: **29/768,728**

(22) Filed: **Feb. 1, 2021**

(51) **LOC (13) Cl.** **15-05**

(52) **U.S. Cl.**
USPC **D32/21**

(58) **Field of Classification Search**
USPC D32/17, 18, 21, 22, 31; D21/526
CPC A47L 5/24; A47L 5/26; A47L 5/28; A47L 9/102; A47L 9/122; A47L 9/127; A47L 9/1608; A47L 9/1683; A47L 9/2857; A47L 9/2884; A47L 9/32; A47L 9/322; B04C 5/185; B08B 3/04; B01D 2279/55; B23Q 11/0046; B23Q 11/0071; E04H 4/1636; Y10T 29/49716
See application file for complete search history.

(56) **References Cited**

U.S. PATENT DOCUMENTS

D280,033 S *	8/1985	Miyamoto	D32/18
D290,894 S *	7/1987	Miyamoto	D32/18
D296,486 S *	6/1988	Staubitz	D32/22
D303,173 S *	8/1989	Miyamoto	D32/22
D323,725 S *	2/1992	Gierke	D32/15
D348,548 S *	7/1994	Pino	D32/18
5,337,443 A *	8/1994	Steinberg	A47L 5/225 15/344
D398,099 S *	9/1998	Leung	D32/22
D405,929 S *	2/1999	Sovis	D32/22
D433,546 S *	11/2000	Milanese	D32/17
D641,112 S *	7/2011	Lee	D32/34
D743,125 S *	11/2015	Lee	D32/22
D861,268 S *	9/2019	Meyer	D32/22
D867,694 S	11/2019	Ma		
D868,403 S	11/2019	Wang		

FOREIGN PATENT DOCUMENTS

CN	306079176	*	9/2020
JP	D1668008	*	9/2020
KR	301085120.0000	*	12/2020

OTHER PUBLICATIONS

E-More Handheld Vacuum Cordless, available in Amazon.com.uk, date first available Jan. 11, 2021 [online], [site visited May 4, 2021, Available from the internet . . . URL: https://www.amazon.co.uk/Handheld-Cordless-Portable-Rechargeable-Lightweight/dp/B08SM4CRPP/ref=sr_1_47?dchild=1&keywords=GeeMo+Handheld+Vacuum+Cleaner%2C+Hand+Vacuum&qid=1620181840&sr=8-47 (Year: 2021).*

(Continued)

Primary Examiner — Dana K Weiland
Assistant Examiner — Jennylou M Binas
(74) *Attorney, Agent, or Firm* — Rumit Ranjit Kanakia

(57) **CLAIM**

The ornamental design for a handheld vacuum cleaner, as shown and described.

DESCRIPTION

FIG. 1 is a front elevational view of a handheld vacuum cleaner showing my new design;
FIG. 2 is a rear elevational view thereof;
FIG. 3 is a left side view thereof;
FIG. 4 is a right side view thereof;
FIG. 5 is a top plan view thereof;
FIG. 6 is a bottom plan view thereof;
FIG. 7 is a perspective view thereof; and,
FIG. 8 is another perspective view thereof.

1 Claim, 8 Drawing Sheets

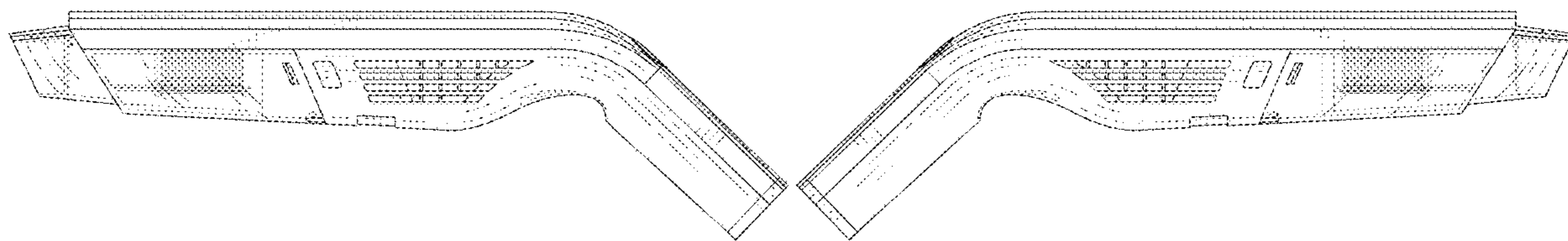

(56)

References Cited

U.S. PATENT DOCUMENTS

D899,719 S 10/2020 Liu
D905,359 S 12/2020 Sun
D907,315 S 1/2021 Tokoi
D908,990 S 1/2021 Chen

OTHER PUBLICATIONS

GeeMo Handheld Vacuum Cleaner, available in Amazon.ca, date first available Feb. 7, 2021 [online], [site visited May 4, 2021, Available from the internet URL: https://www.amazon.ca/GeeMo-Brushless-Multi-attachments-Lightweight-G12/dp/B08DJ5WD5G/ref=sr_1_3?dchild=1&keywords=GeeMo+Handheld+Vacuum+Cleaner&qid=1620181623&s=kitchen&sr=1-3 (Year: 2021).*

BuTure Handheld Vacuum Cordless, available in Amazon.com.uk, date first available Oct. 9, 2020 [online], [site visited May 4, 2021, Available from the internet URL: https://www.amazon.co.uk/BuTure-Handheld-Cordless-Rechargable-Portable/dp/B08HVGBFHL/ref=psdc_3147731_t5_B08L575DXW (Year: 2020).*

Shark W1, Handheld Vacuum, available in Amazon.co.uk, date first available Aug. 13, 2018 [online], [site visited May 4, 2021, Available from the internet . . . URL: https://www.amazon.co.uk/Handheld-Lightweight-Powerful-Detachable-WV201/dp/B07FX5K4D6/ref=sr_1_3?dchild=1&keywords=Shark+W1%2C+Handheld+Vacuum&qid=1620182094&s=kitchen&sr=1-3 (Year: 2018).*

* cited by examiner

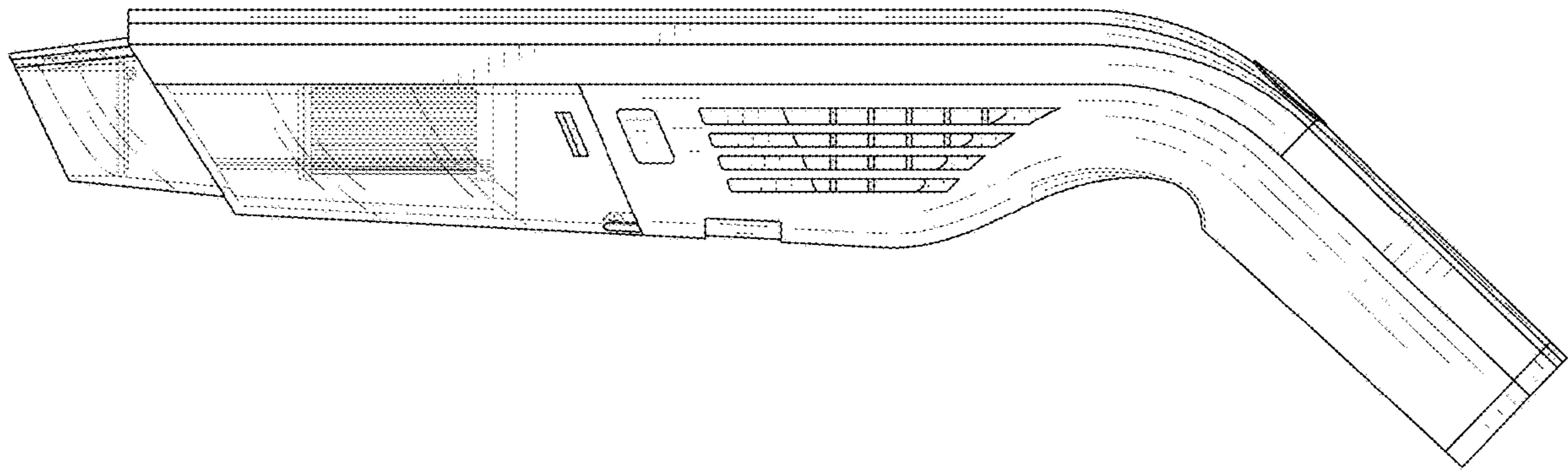

FIG.1

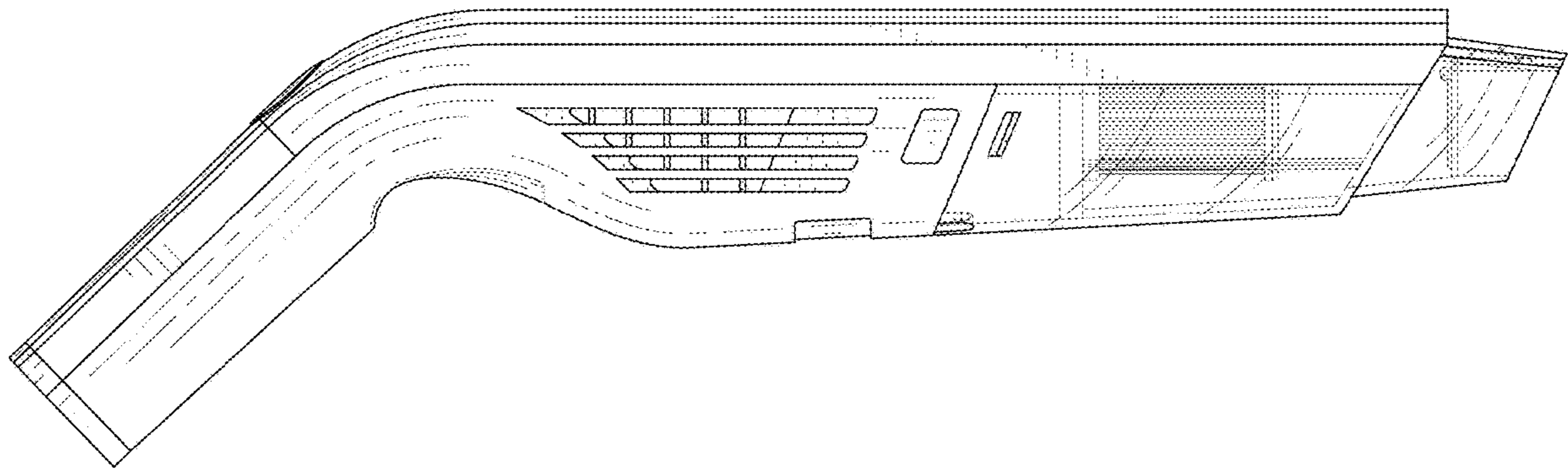

FIG.2

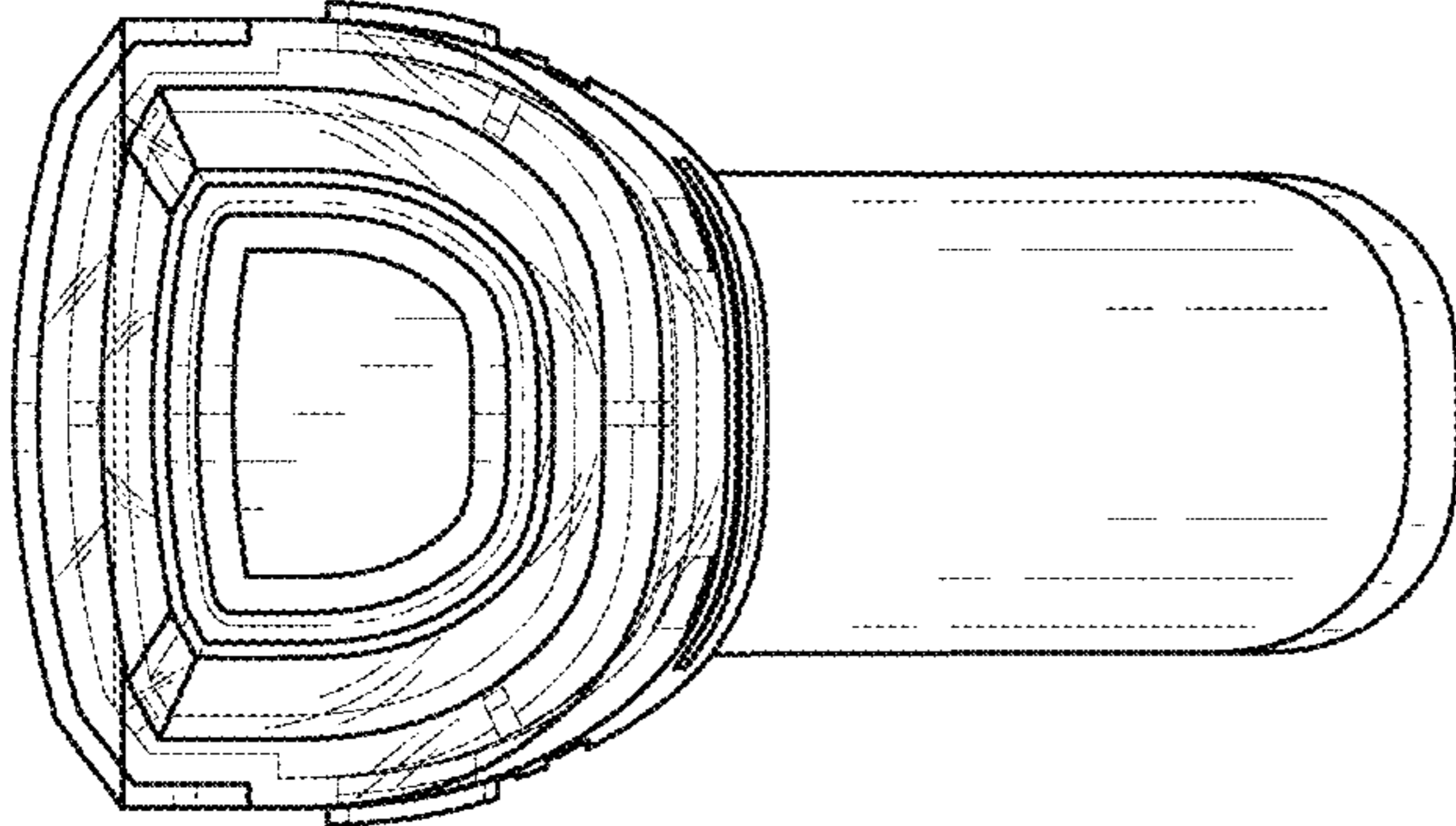

FIG.3

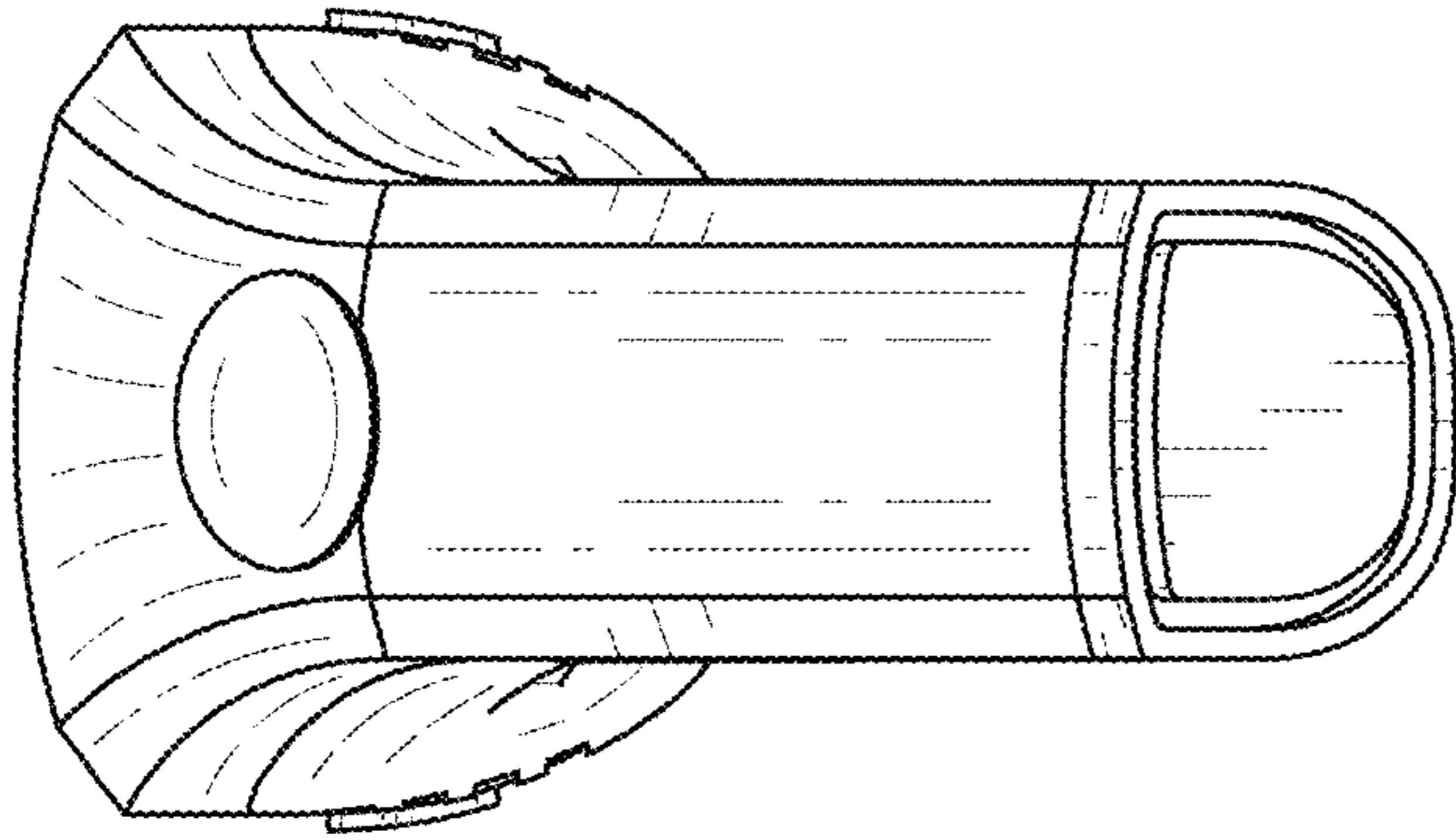

FIG.4

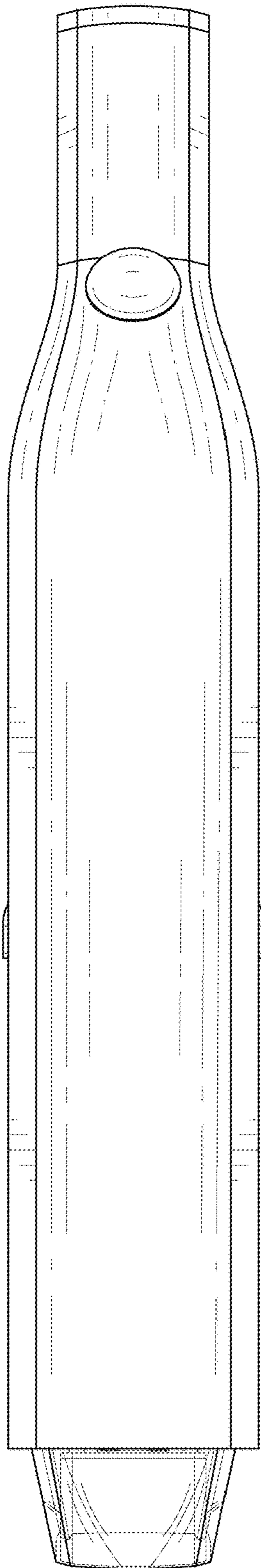

FIG. 5

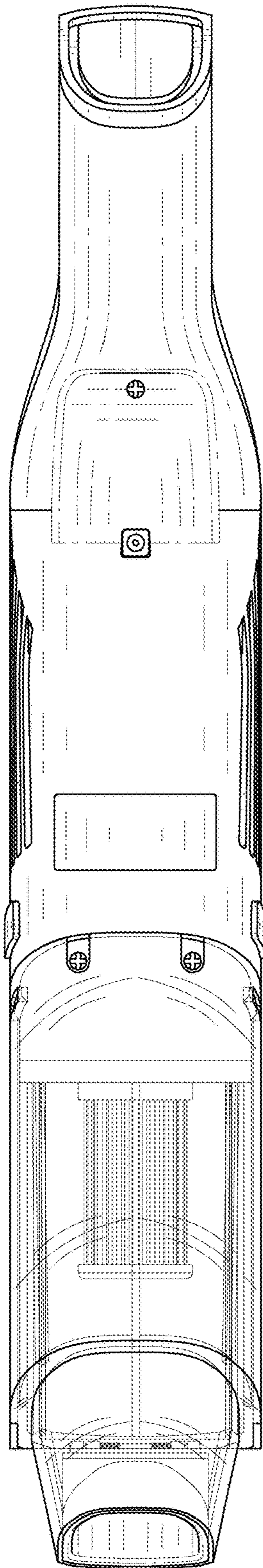

FIG.6

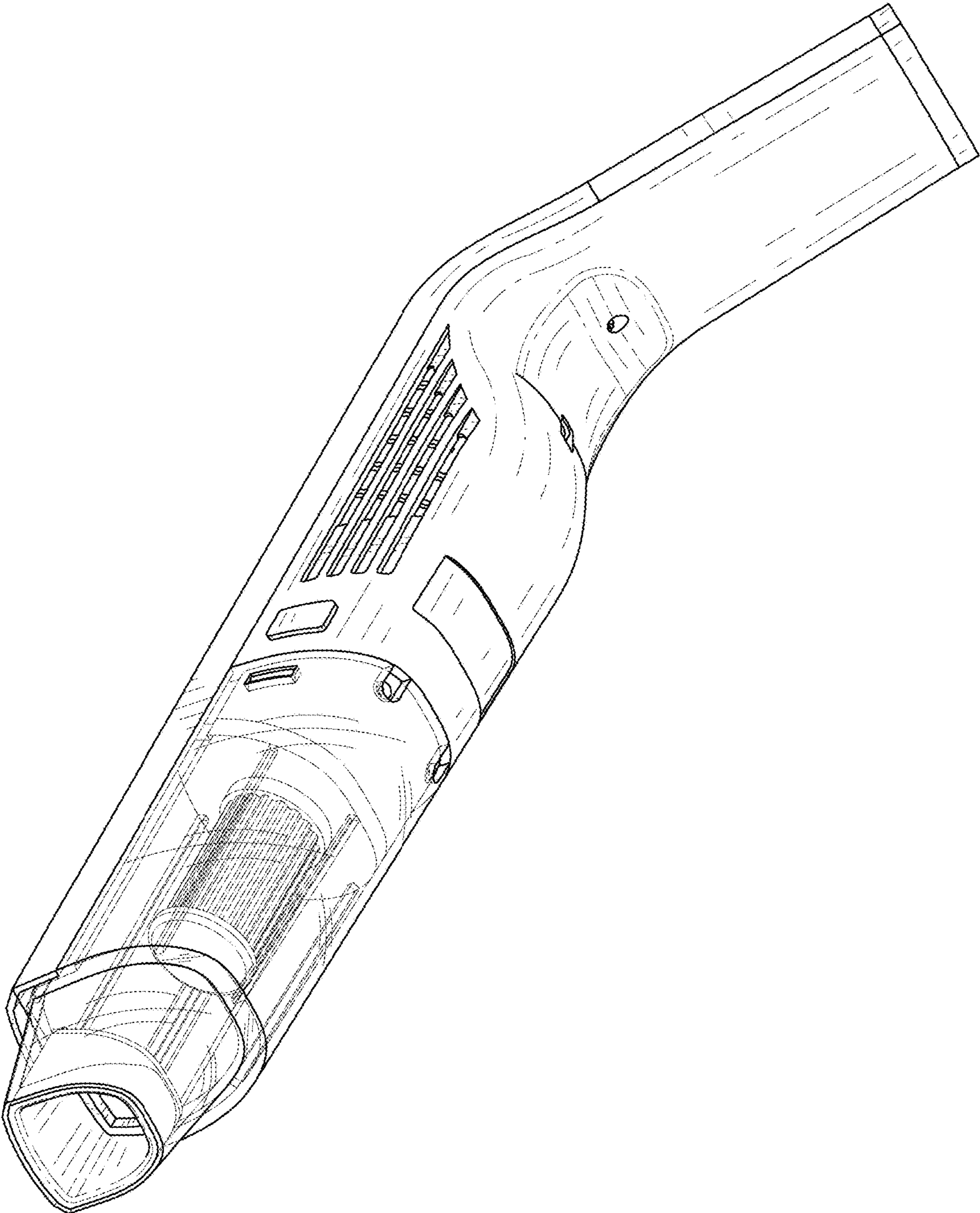

FIG. 7

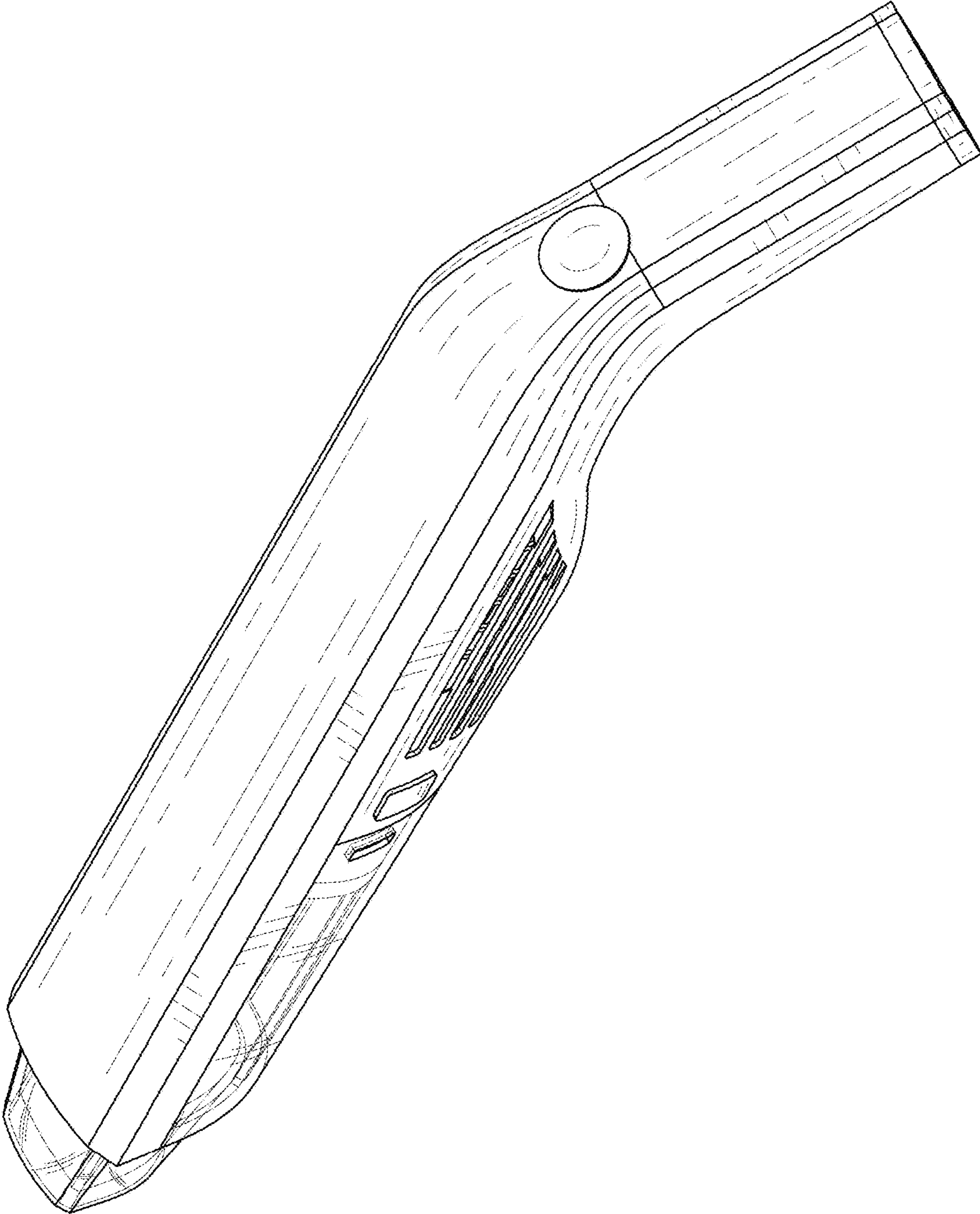

FIG. 8