



US00D923792S

(12) **United States Design Patent** (10) **Patent No.:** **US D923,792 S**
Hollis et al. (45) **Date of Patent:** **** Jun. 29, 2021**

(54) **BONE PLATE FEATURES**
(71) Applicant: **CROSSROADS EXTREMITY SYSTEMS, LLC**, Memphis, TN (US)
(72) Inventors: **Michael Chad Hollis**, Collierville, TN (US); **Daniel Sayger**, Southaven, MS (US)
(73) Assignee: **CROSSROADS EXTREMITY SYSTEMS, LLC**, Memphis, TN (US)
(**) Term: **15 Years**
(21) Appl. No.: **29/739,900**
(22) Filed: **Jun. 30, 2020**

Related U.S. Application Data

(63) Continuation of application No. 29/711,465, filed on Oct. 31, 2019, now Pat. No. Des. 891,619, which is a (Continued)
(51) **LOC (13) Cl.** **24-03**
(52) **U.S. Cl.**
USPC **D24/155**
(58) **Field of Classification Search**
USPC D24/155-157
(Continued)

References Cited

U.S. PATENT DOCUMENTS

5,938,664 A 8/1999 Winquist
D469,533 S 1/2003 Bryant
(Continued)

Primary Examiner — Charles D Hanson
(74) *Attorney, Agent, or Firm* — Maywood IP Law;
David Meibos

(57) **CLAIM**
The ornamental design for bone plate features, as shown and described.

DESCRIPTION

FIG. 1 is a top perspective view of bone plate features; FIG. 2 is a bottom perspective view of the bone plate features of FIG. 1; FIG. 3 is a front view of the bone plate features of FIG. 1; FIG. 4 is a back view of the bone plate features of FIG. 1; FIG. 5 is a left view of the bone plate features of FIG. 1; FIG. 6 is a right view of the bone plate features of FIG. 1; FIG. 7 is a top view of the bone plate features of FIG. 1; FIG. 8 is a bottom view of the bone plate features of FIG. 1.
FIG. 9 is a top perspective view of bone plate features; FIG. 10 is a bottom perspective view of the bone plate features of FIG. 9; FIG. 11 is a front view of the bone plate features of FIG. 9; FIG. 12 is a back view of the bone plate features of FIG. 9; FIG. 13 is a left view of the bone plate features of FIG. 9; FIG. 14 is a right view of the bone plate features of FIG. 9; FIG. 15 is a top view of the bone plate features of FIG. 9; and
FIG. 16 is a bottom view of the bone plate features of FIG. 9.
FIG. 17 is a top perspective view of bone plate features; FIG. 18 is a bottom perspective view of the bone plate features of FIG. 17; FIG. 19 is a front view of the bone plate features of FIG. 17; FIG. 20 is a back view of the bone plate features of FIG. 17; FIG. 21 is a left view of the bone plate features of FIG. 17; FIG. 22 is a right view of the bone plate features of FIG. 17; FIG. 23 is a top view of the bone plate features of FIG. 17; and
FIG. 24 is a bottom view of the bone plate features of FIG. 17.
In the drawings, the broken lines depict environmental subject matter only and form no part of the claimed design.

1 Claim, 18 Drawing Sheets

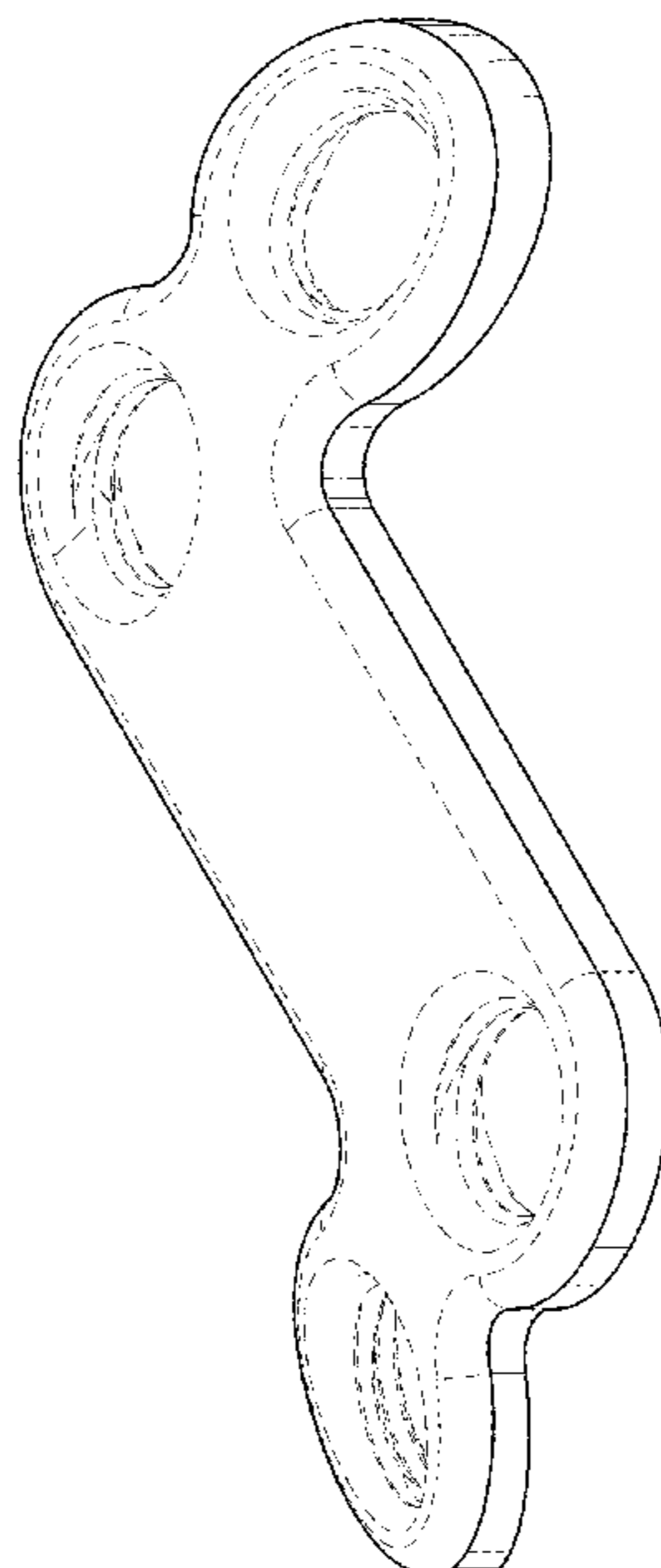

Related U.S. Application Data
 continuation of application No. 29/612,209, filed on
 Jul. 31, 2017, now Pat. No. Des. 869,657.

(58) **Field of Classification Search**
 CPC A61B 17/8061; A61B 17/7059; A61B
 17/8052; A61B 17/8605; A61B 17/8085;
 A61B 17/809; A61B 17/8014; A61B
 17/8033; A61B 17/8004; A61B 17/888;
 A61B 17/842; A61B 17/8023; A61B
 17/8009; A61B 17/86; A61B 17/1739;
 A61B 17/8066; A61B 17/1671; A61B
 17/1757; A61B 17/8071; A61B 17/176

See application file for complete search history.

(56) **References Cited**
 U.S. PATENT DOCUMENTS

D480,141 S 9/2003 Benirschke
 D520,637 S * 5/2006 Kay D24/155
 D580,057 S 11/2008 Ramadani
 D648,027 S * 11/2011 Vancelette D24/155

8,257,405 B2 9/2012 Haidukewych
 8,398,687 B2 3/2013 Vasta
 D699,351 S 2/2014 Podgorski
 8,940,026 B2 1/2015 Hilse
 D740,943 S * 10/2015 Neufeld A61B 17/8061
 D24/155

D745,162 S 12/2015 Neufeld
 9,204,912 B2 12/2015 Price
 9,333,014 B2 5/2016 Gonzalez-Hernandez
 9,387,020 B2 7/2016 Geissler
 D765,850 S 9/2016 Early
 D765,852 S 9/2016 Early
 D766,438 S 9/2016 DaCosta
 D766,439 S 9/2016 DaCosta
 D767,135 S 9/2016 Paik
 D767,136 S 9/2016 Paik
 D869,657 S * 12/2019 Hollis D24/155
 D891,619 S * 7/2020 Hollis D24/155

2004/0210220 A1 10/2004 Tornier
 2004/0225291 A1 11/2004 Schwammberger
 2005/0182408 A1 8/2005 Pfefferle
 2008/0021452 A1 1/2008 Ducharme
 2013/0116734 A1 5/2013 Gonzalez-Hernandez
 2017/0007305 A1 1/2017 Hollis

* cited by examiner

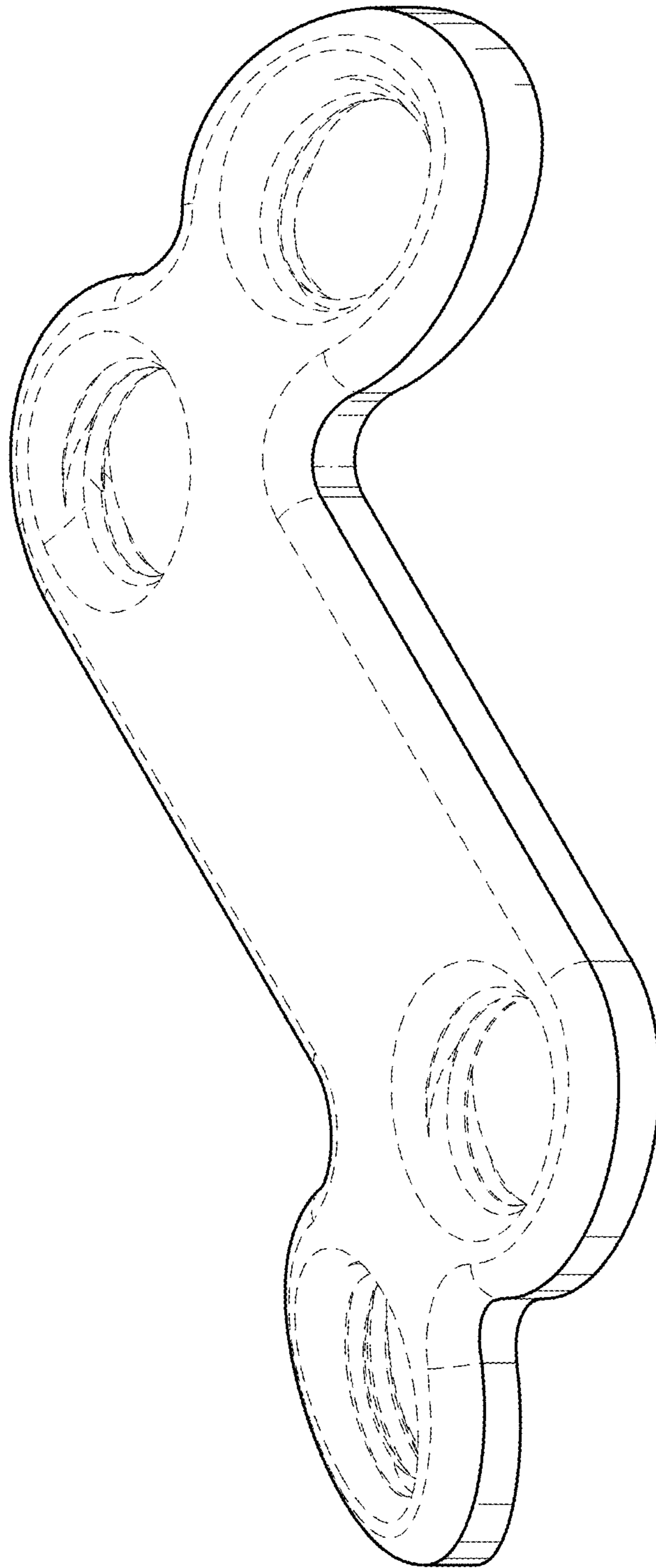

FIG. 1

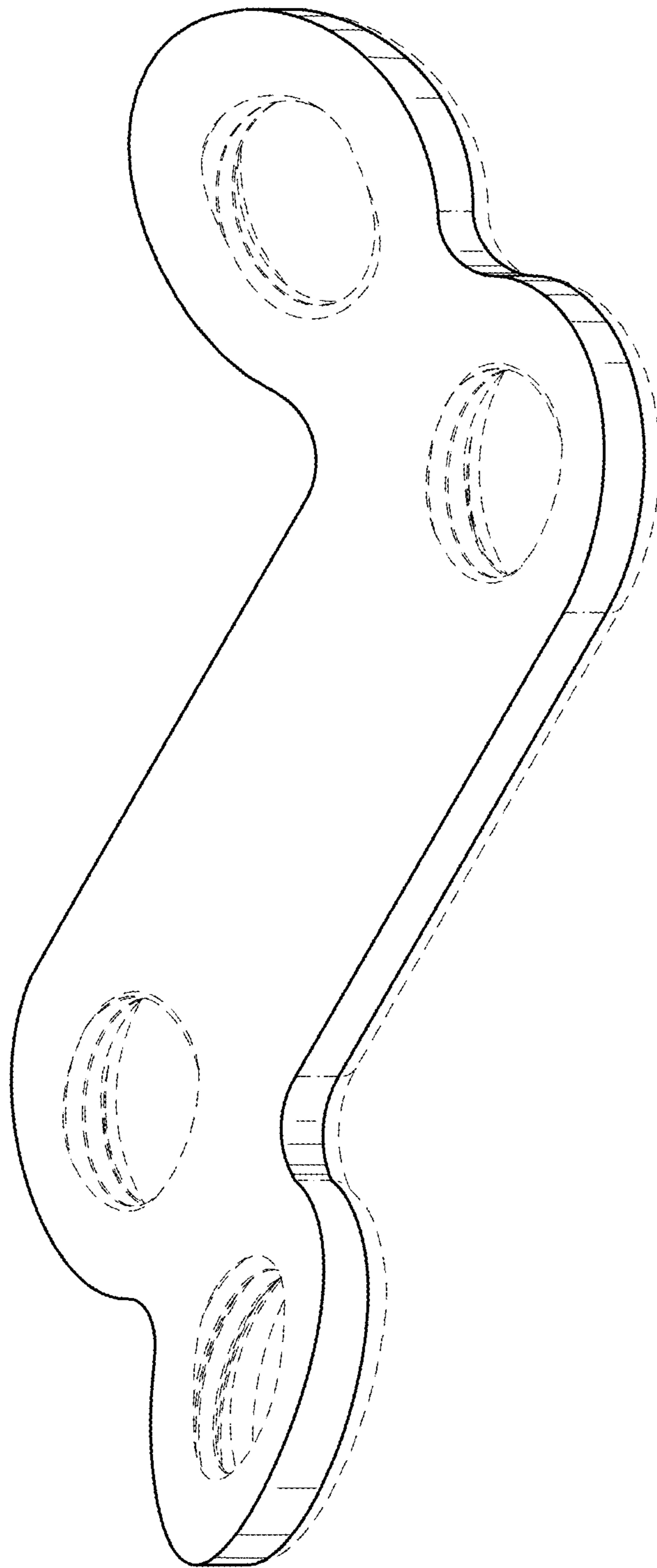

FIG. 2

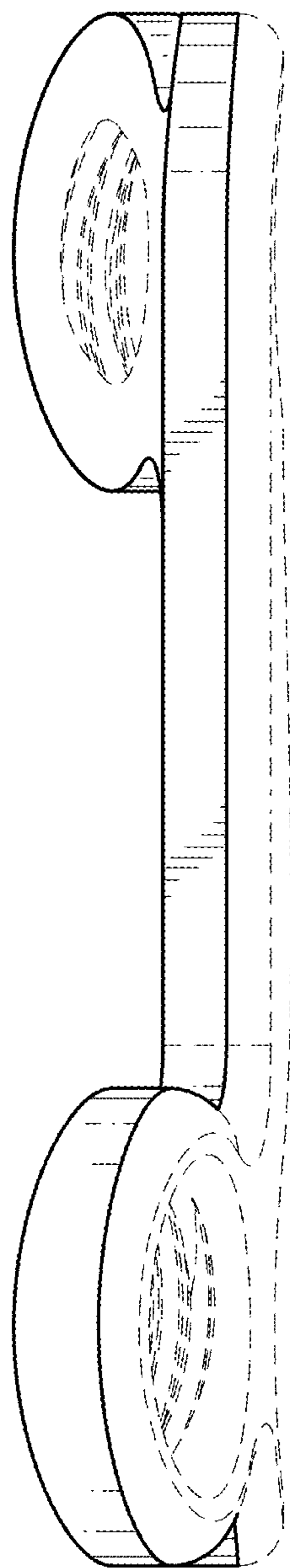

FIG. 3

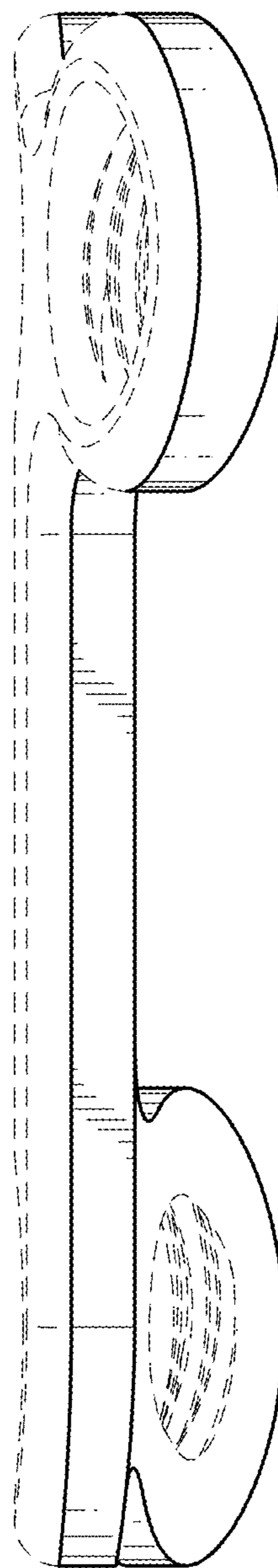

FIG. 4

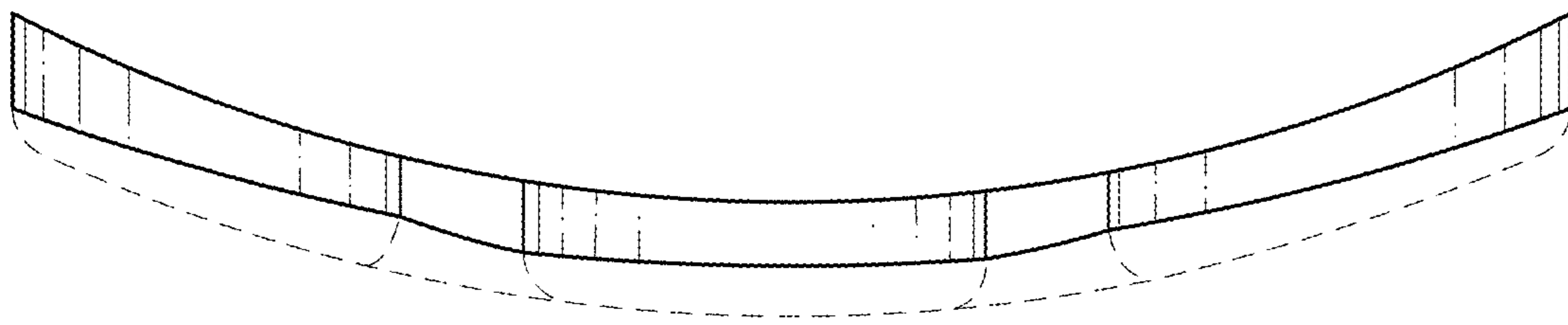

FIG. 5

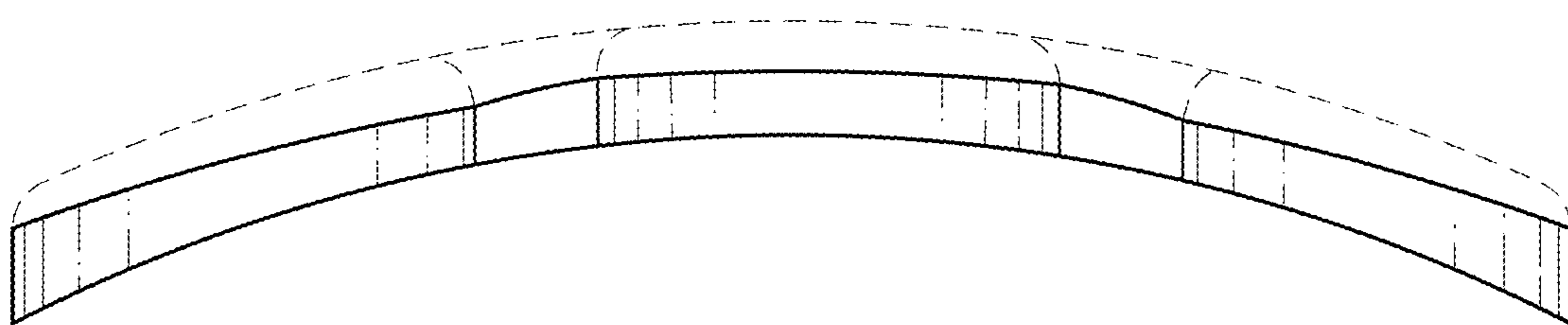

FIG. 6

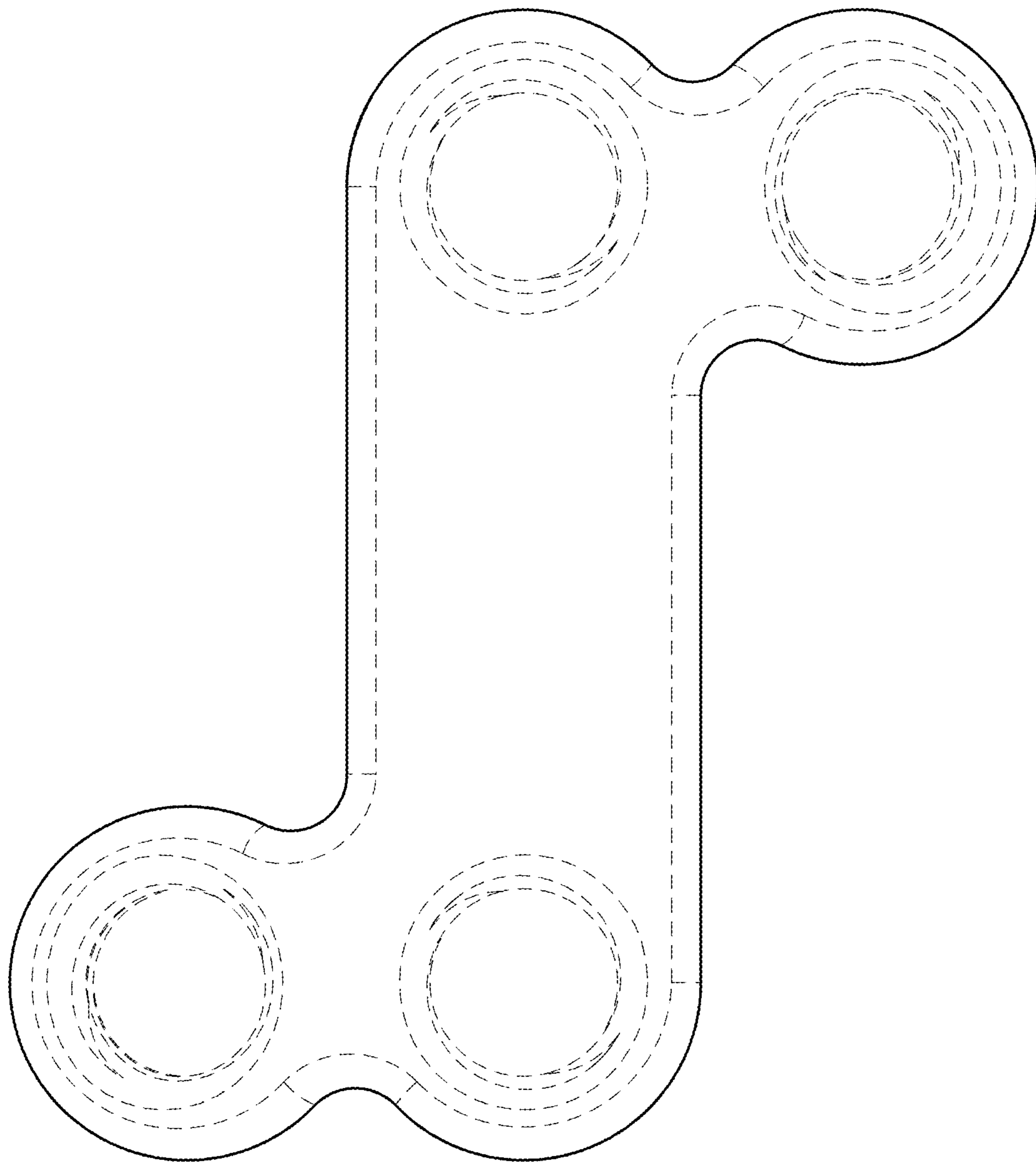

FIG. 7

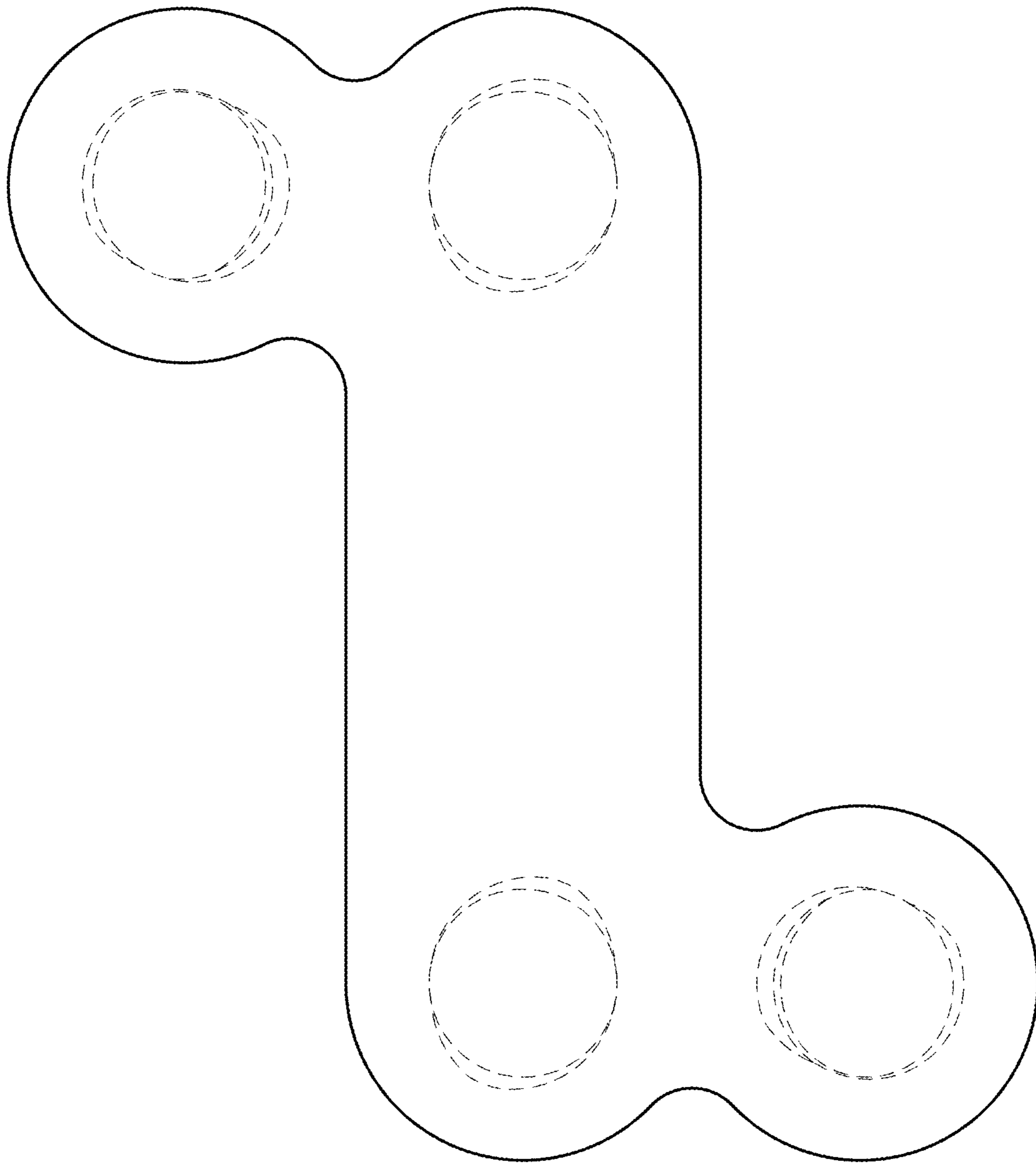

FIG. 8

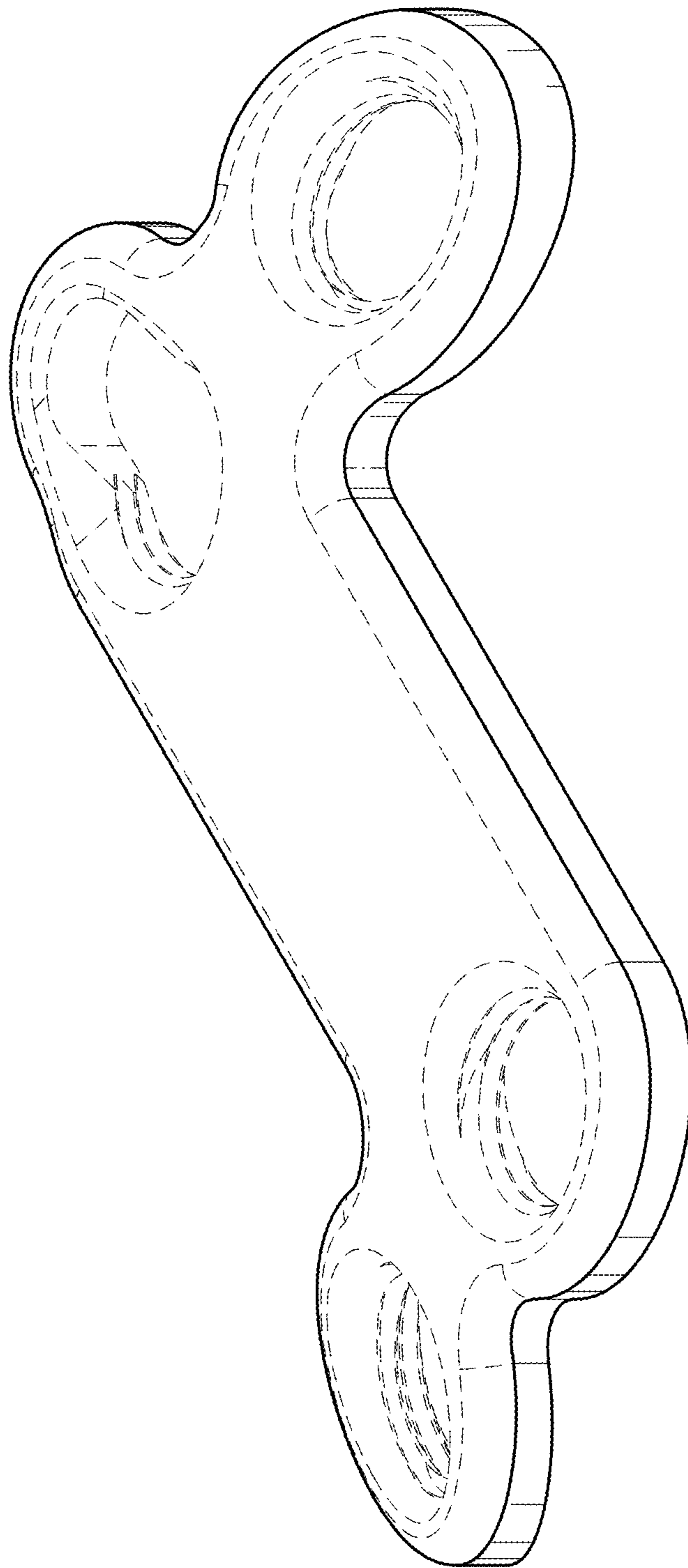

FIG. 9

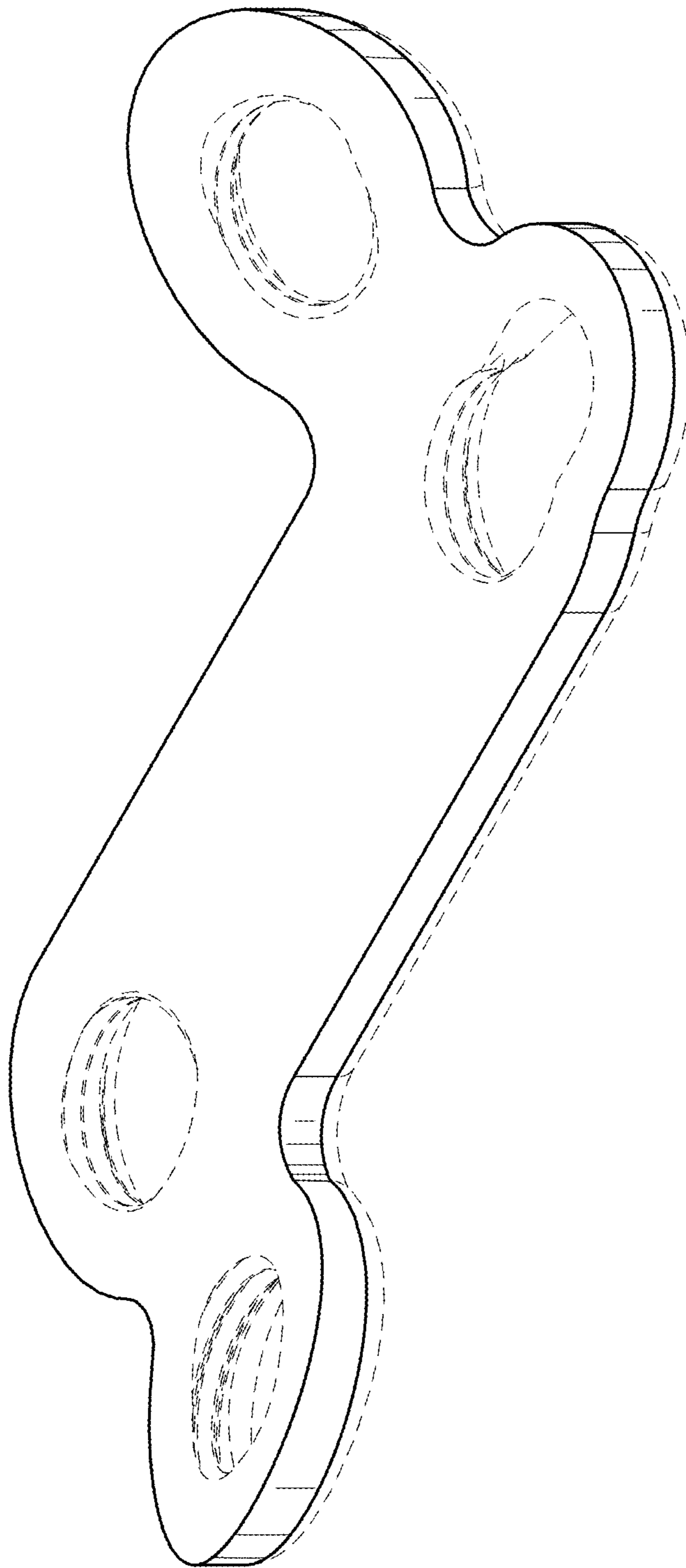

FIG. 10

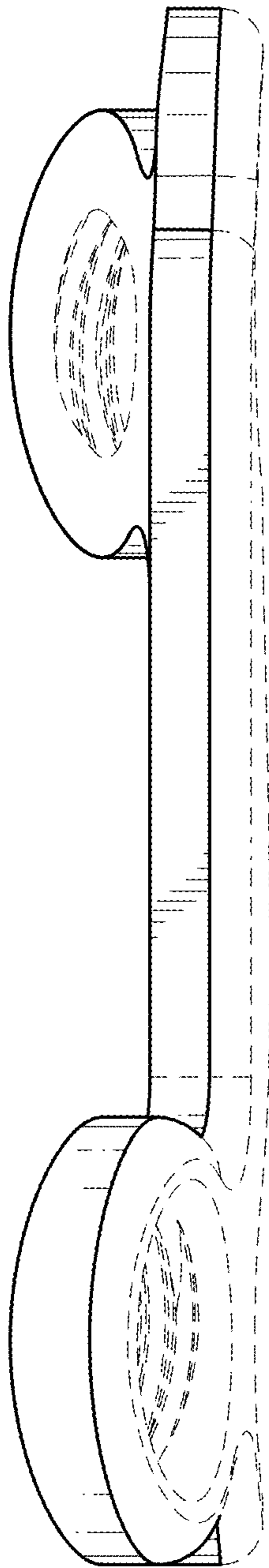

FIG. 11

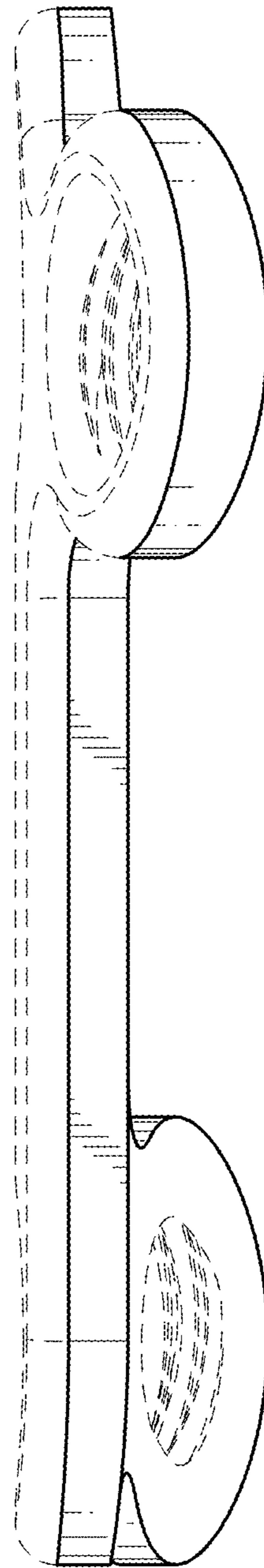

FIG. 12

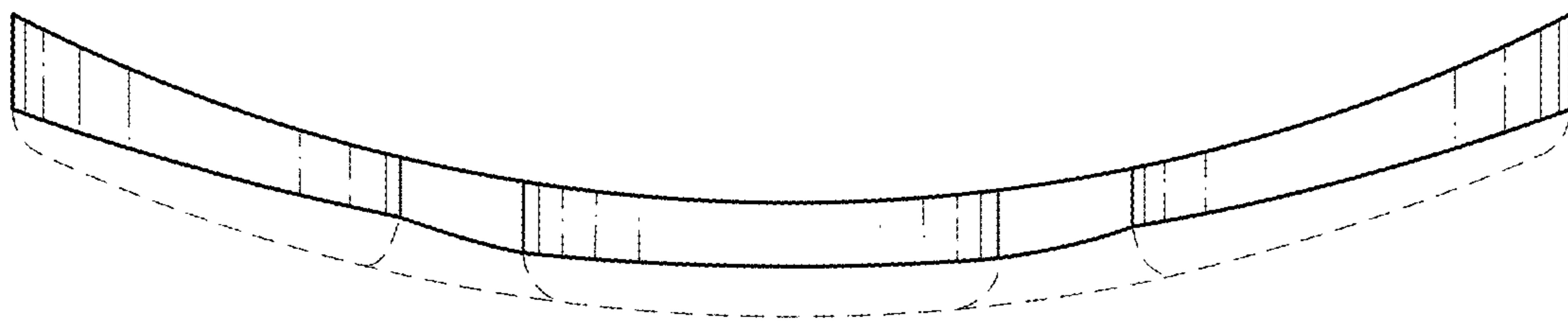

FIG. 13

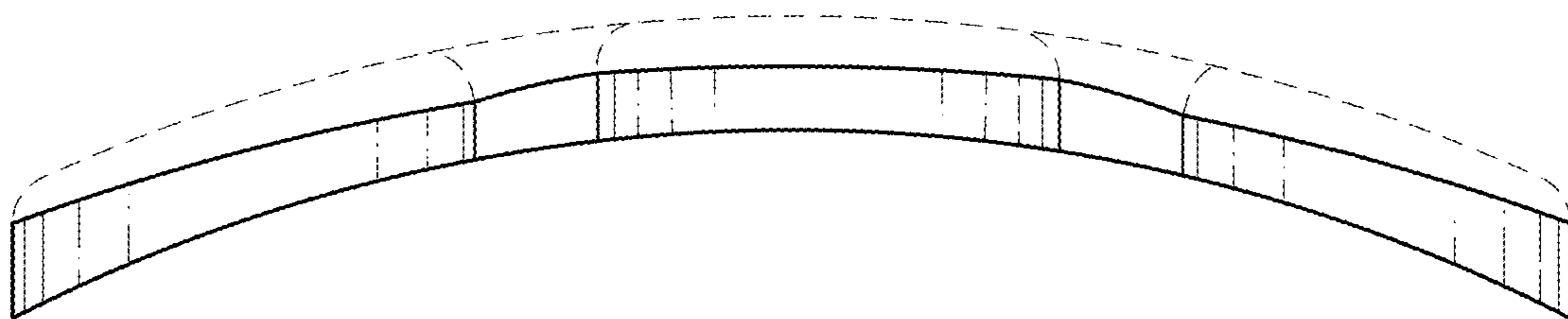

FIG. 14

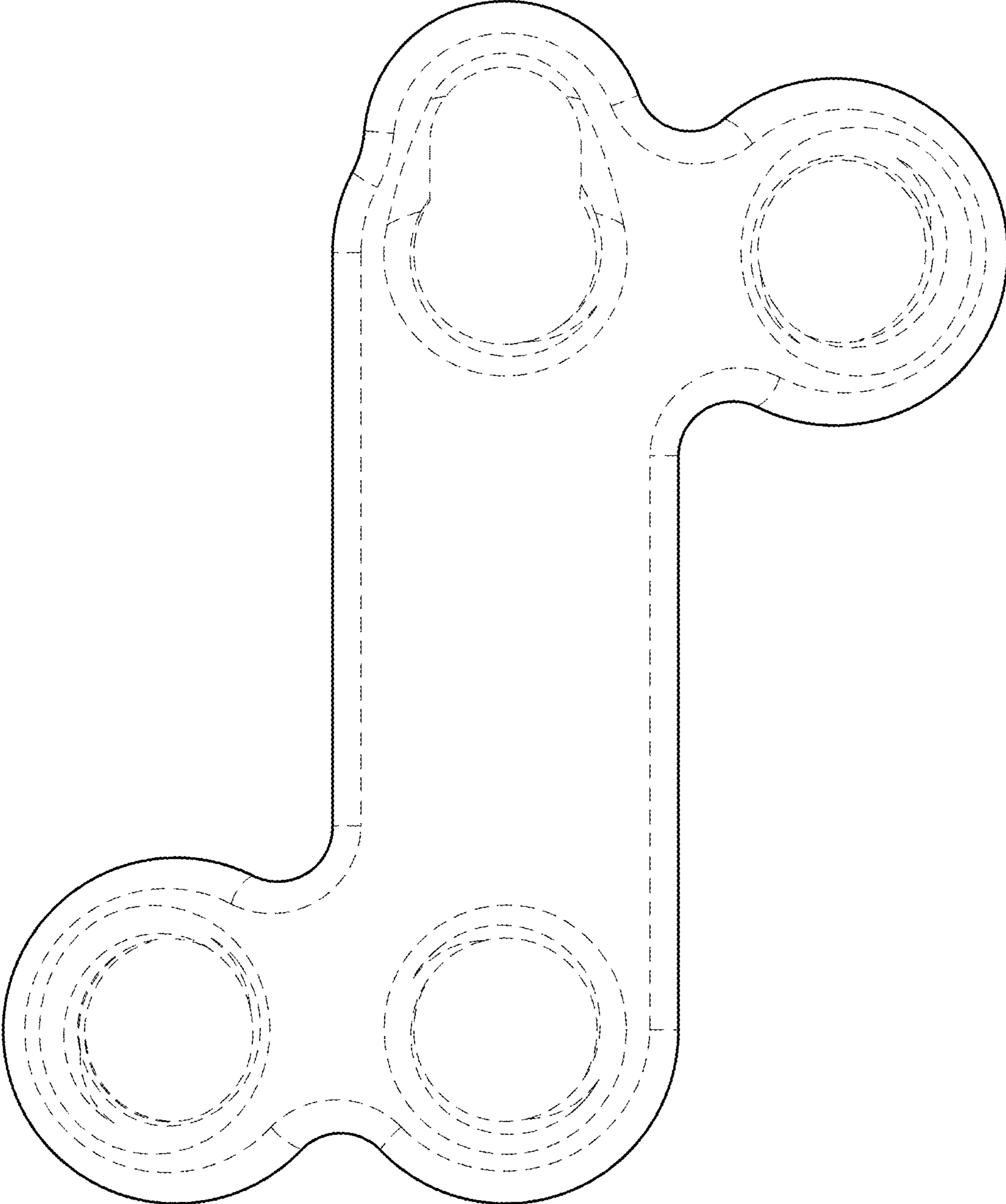

FIG. 15

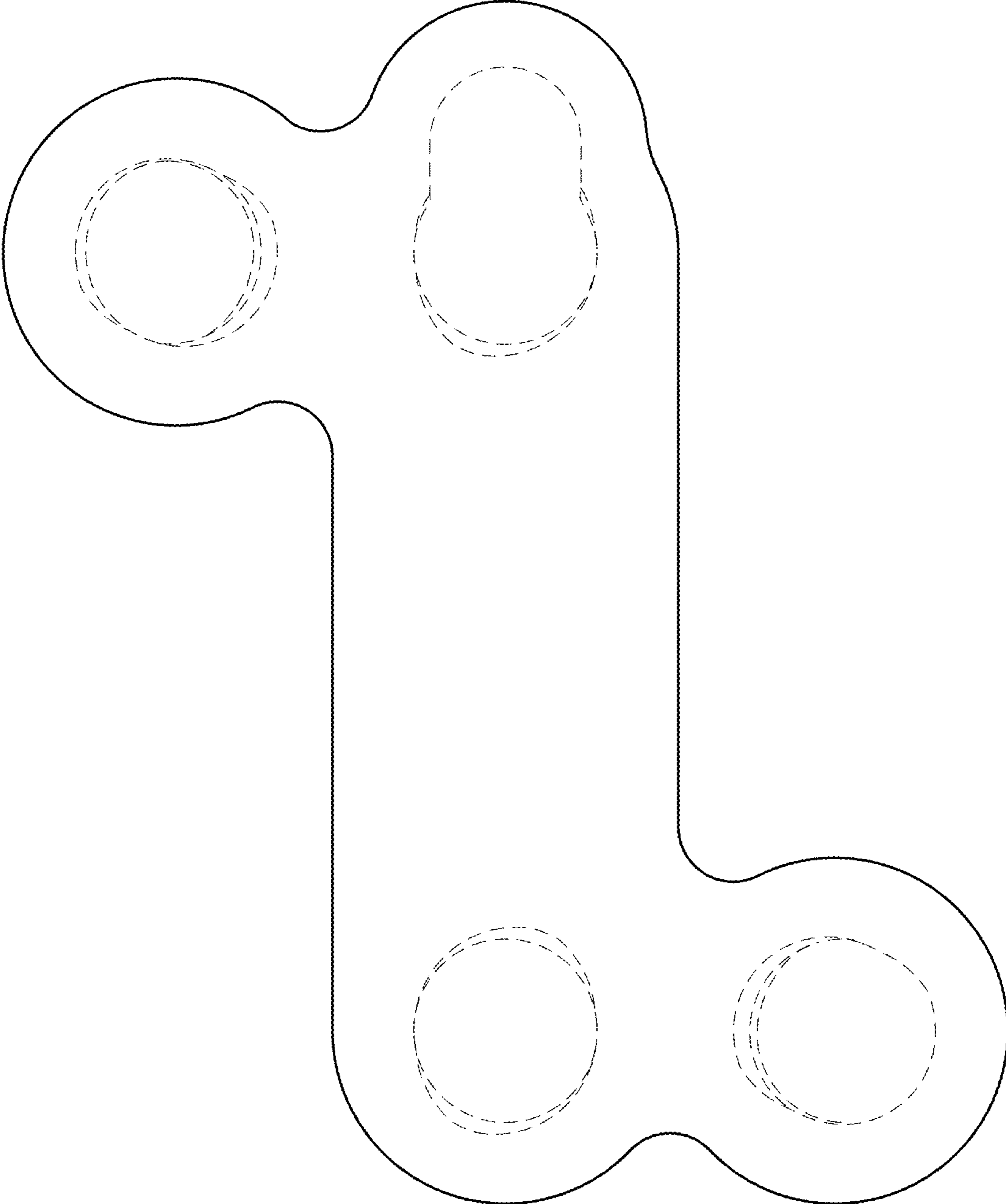

FIG. 16

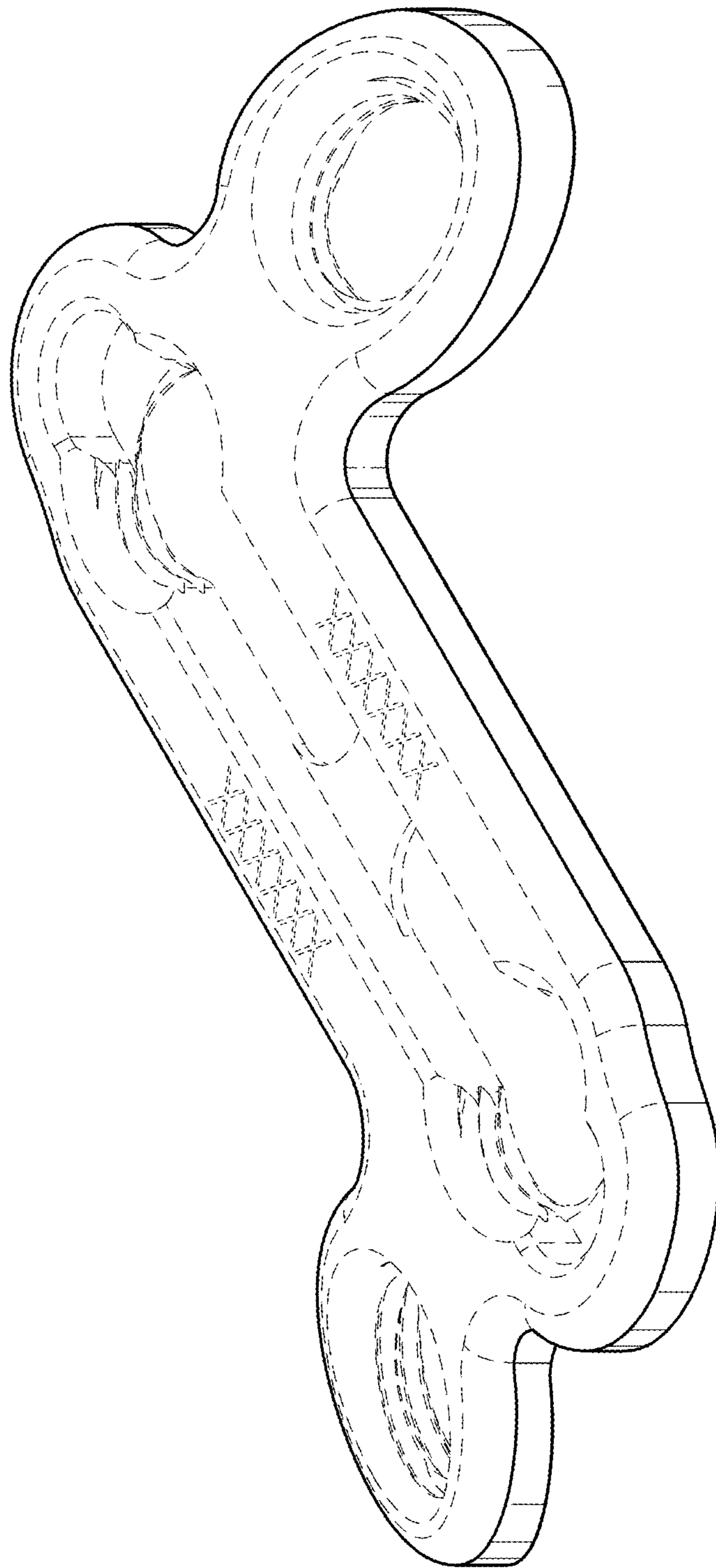

FIG. 17

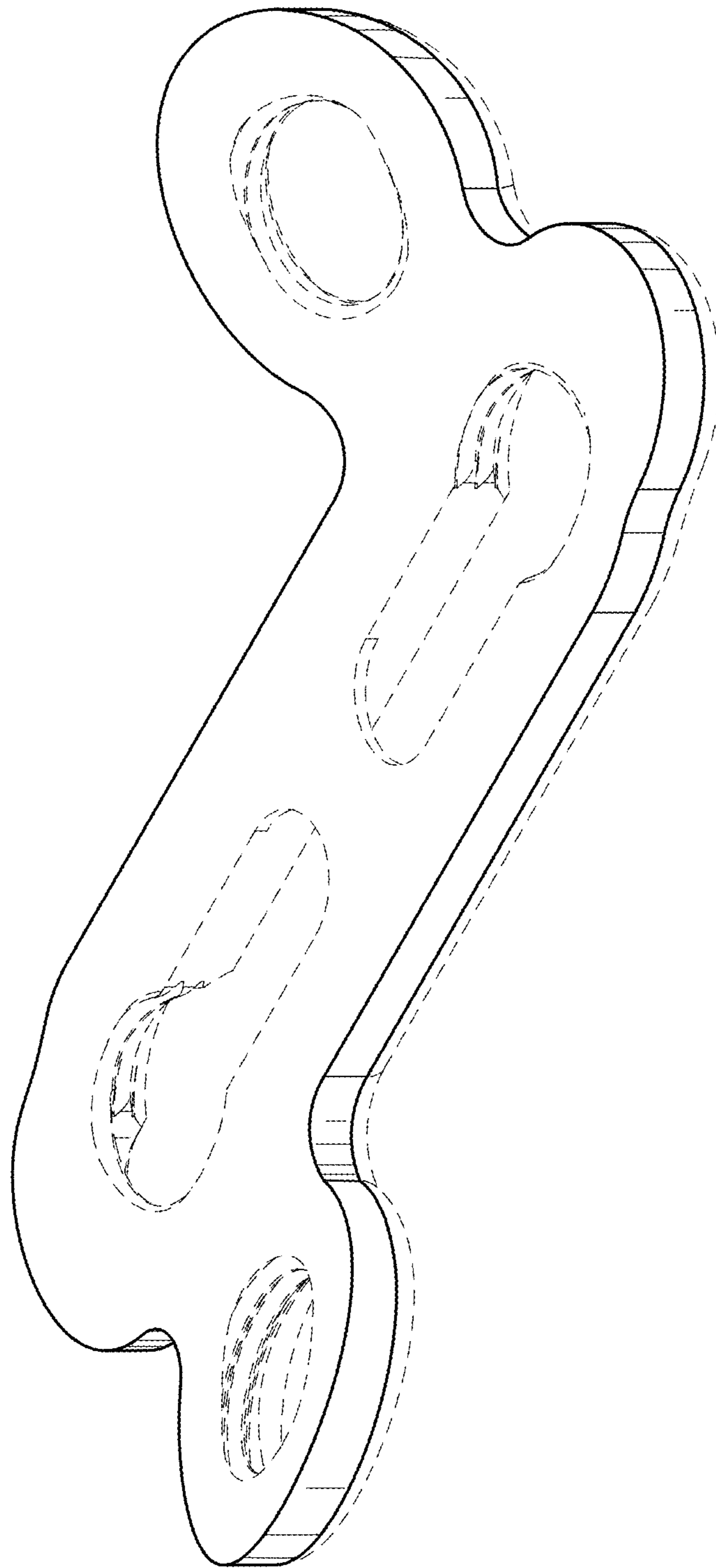

FIG. 18

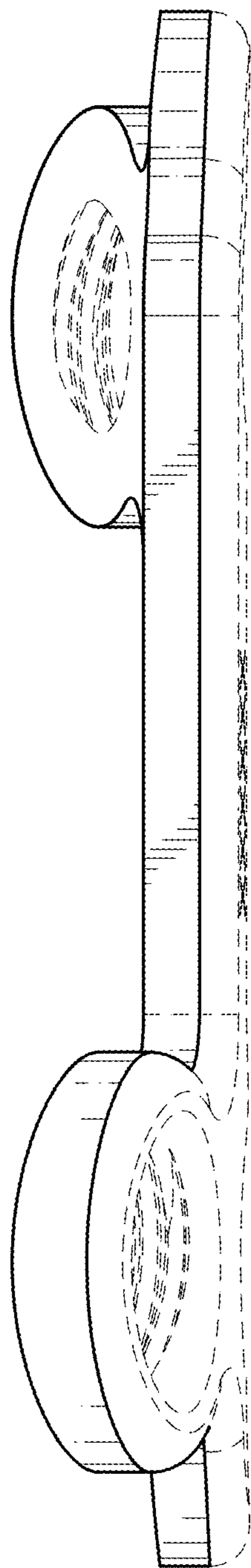

FIG. 19

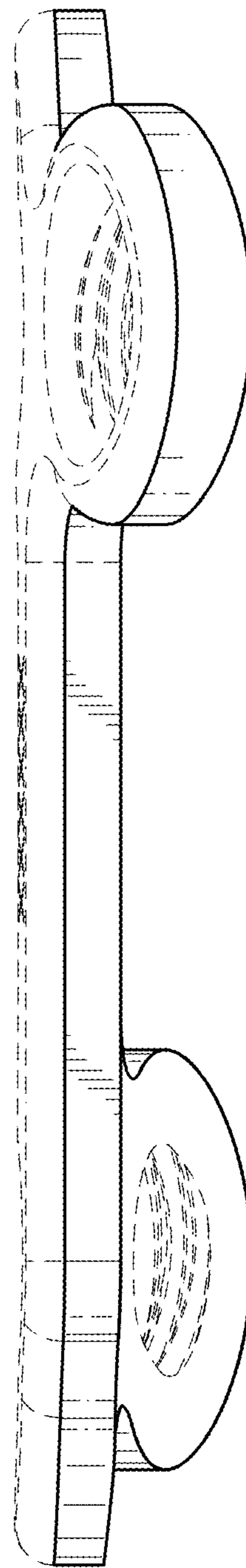

FIG. 20

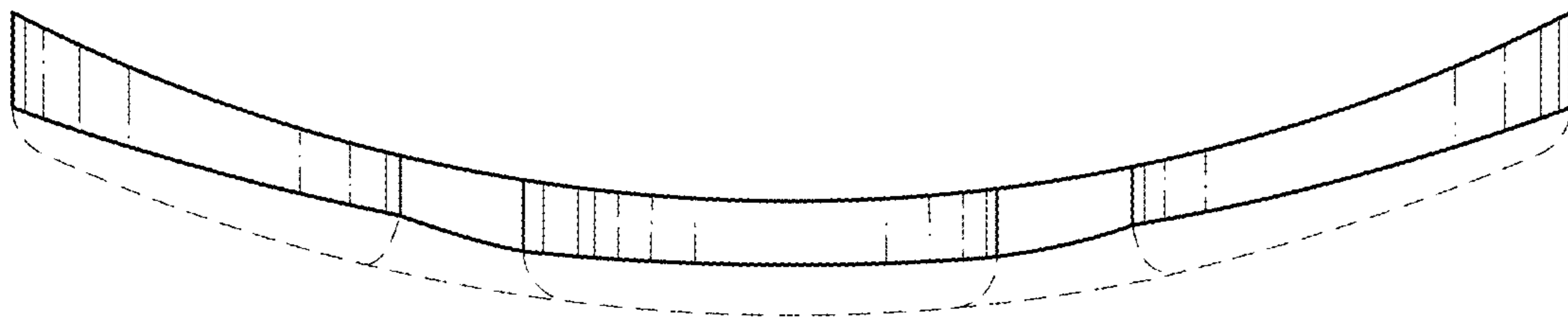

FIG. 21

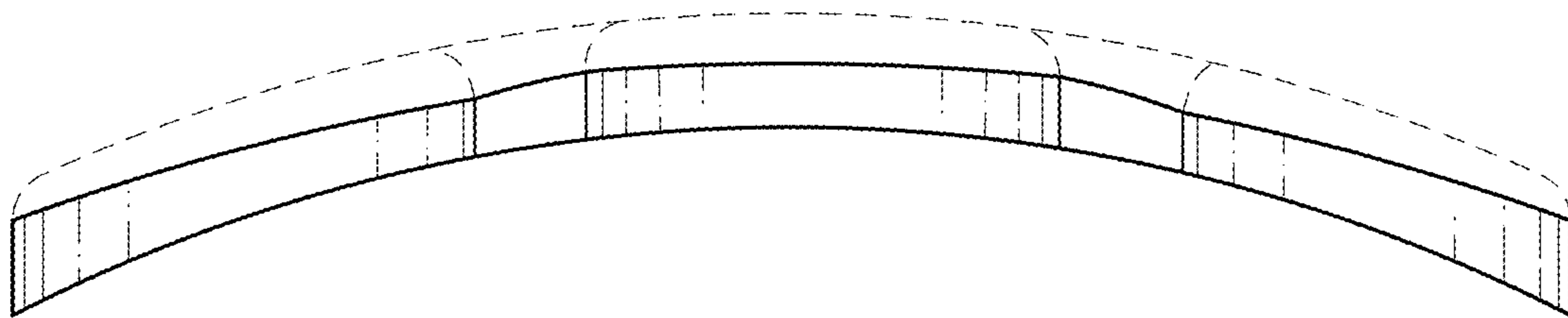

FIG. 22

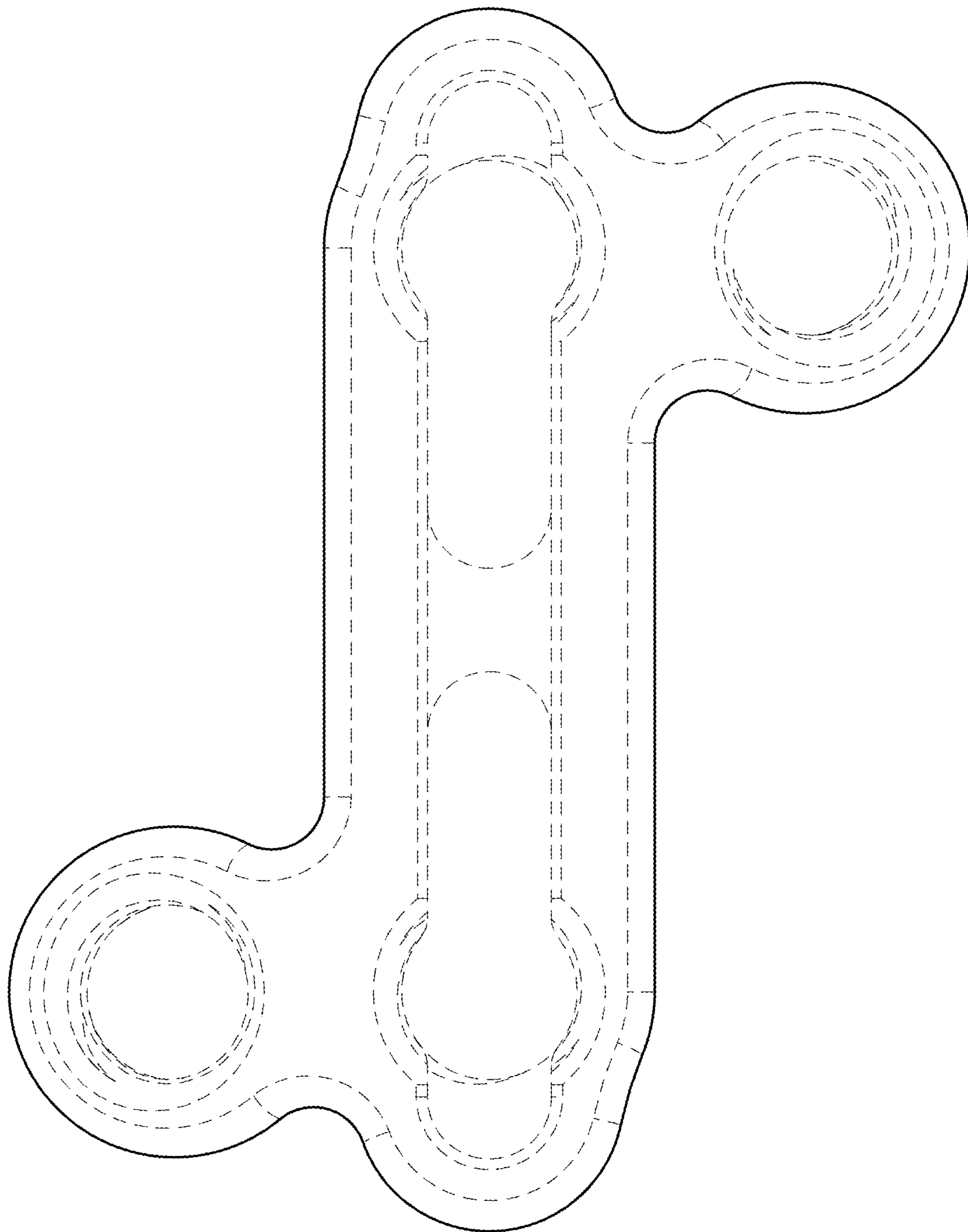

FIG. 23

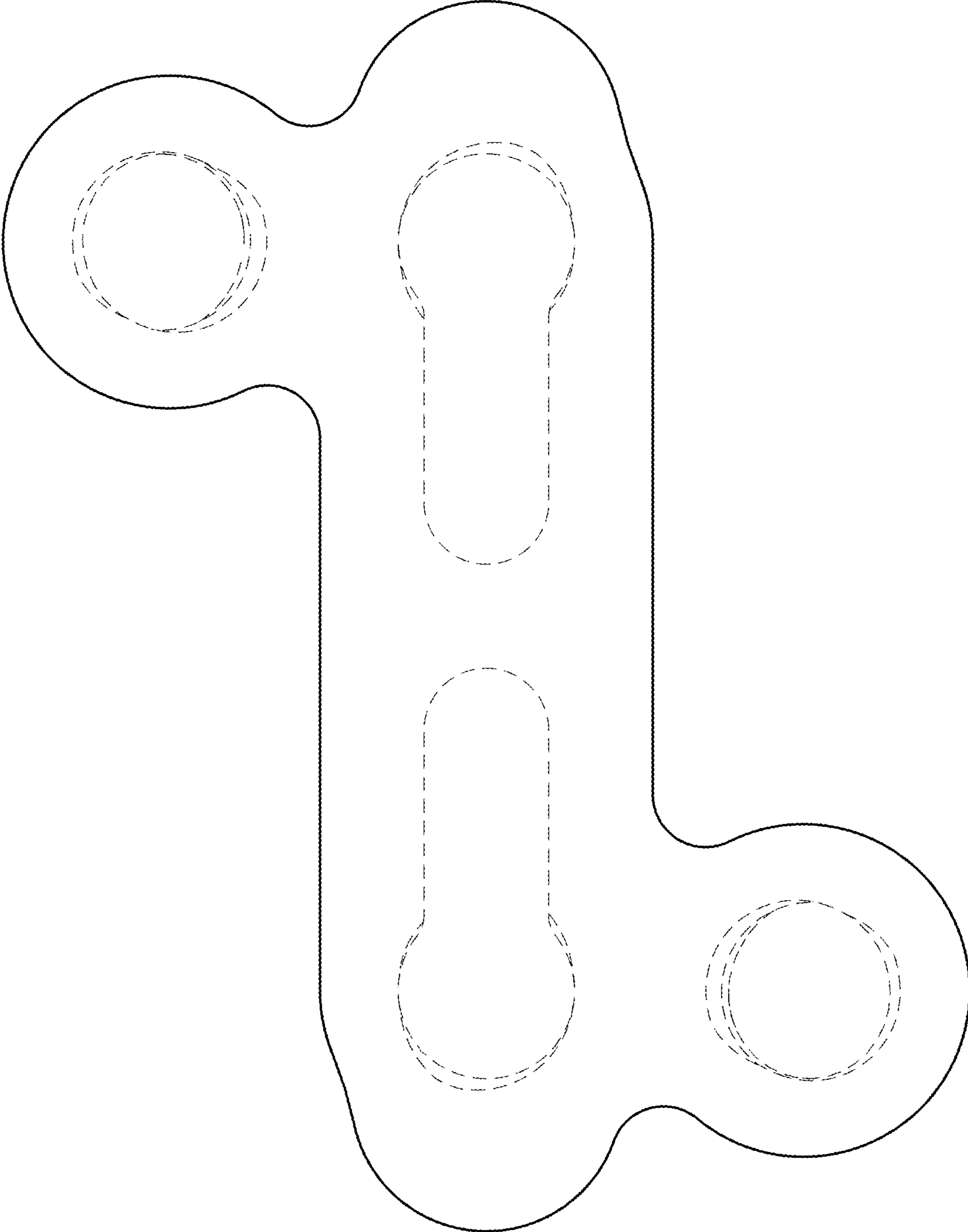

FIG. 24