



US00D923772S

(12) **United States Design Patent**
Chen

(10) **Patent No.:** **US D923,772 S**

(45) **Date of Patent:** **** Jun. 29, 2021**

(54) **FAN**
(71) Applicant: **MIDEA GROUP CO., LTD.**, Foshan (CN)
(72) Inventor: **Wei Chen**, Guangdong (CN)
(73) Assignee: **MIDEA GROUP CO., LTD.**, Foshan (CN)
(**) Term: **15 Years**

D341,652 S * 11/1993 Marino D23/378
D346,440 S * 4/1994 Chiu D23/378
D355,483 S * 2/1995 Litvin D23/378
D414,858 S * 10/1999 Litvin D23/378
D416,081 S * 11/1999 Lee D23/378
D418,913 S * 1/2000 Thakur D23/378
D420,734 S * 2/2000 Thakur D23/378
D426,631 S * 6/2000 Thakur D23/378
D459,464 S * 6/2002 Chura D23/411
D511,570 S * 11/2005 Ke D23/378
D737,420 S * 8/2015 Yeung D23/382
D762,837 S * 8/2016 Yeung D23/378
D881,371 S * 4/2020 Hollinger D23/382

(21) Appl. No.: **35/509,393**

* cited by examiner

(22) Filed: **Dec. 10, 2019**

Primary Examiner — Natasha Vujcic

(80) **Hague Agreement Data**

(74) *Attorney, Agent, or Firm* — Morgan, Lewis & Bockius LLP

Int. Filing Date: **Dec. 10, 2019**
Int. Reg. No.: **DM/207985**
Int. Reg. Date: **Dec. 10, 2019**
Int. Reg. Pub. Date: **May 22, 2020**

(57) **CLAIM**

(30) **Foreign Application Priority Data**

The ornamental design for a fan, as shown and described.

Sep. 20, 2019 (CN) 201930517226.2

(51) **LOC (13) Cl.** **23-04**

(52) **U.S. Cl.**
USPC **D23/378**

(58) **Field of Classification Search**
USPC D23/370–385, 411–414; D13/179
CPC F04D 25/088; F04D 25/06; F04D 29/38;
F04D 29/522; F04D 29/5853; F04D
29/326; F01P 5/02
See application file for complete search history.

DESCRIPTION

- 1. Fan
- 1.1 : Front
- 1.2 : Back
- 1.3 : Left
- 1.4 : Right
- 1.5 : Top
- 1.6 : Bottom
- 1.7 : Perspective
- 1.8 : Perspective view of using state
- 1.9 : Perspective view of using state

(56) **References Cited**

U.S. PATENT DOCUMENTS

D314,428 S * 2/1991 Wang D23/378
D316,599 S * 4/1991 Wang D23/378

1 Claim, 9 Drawing Sheets

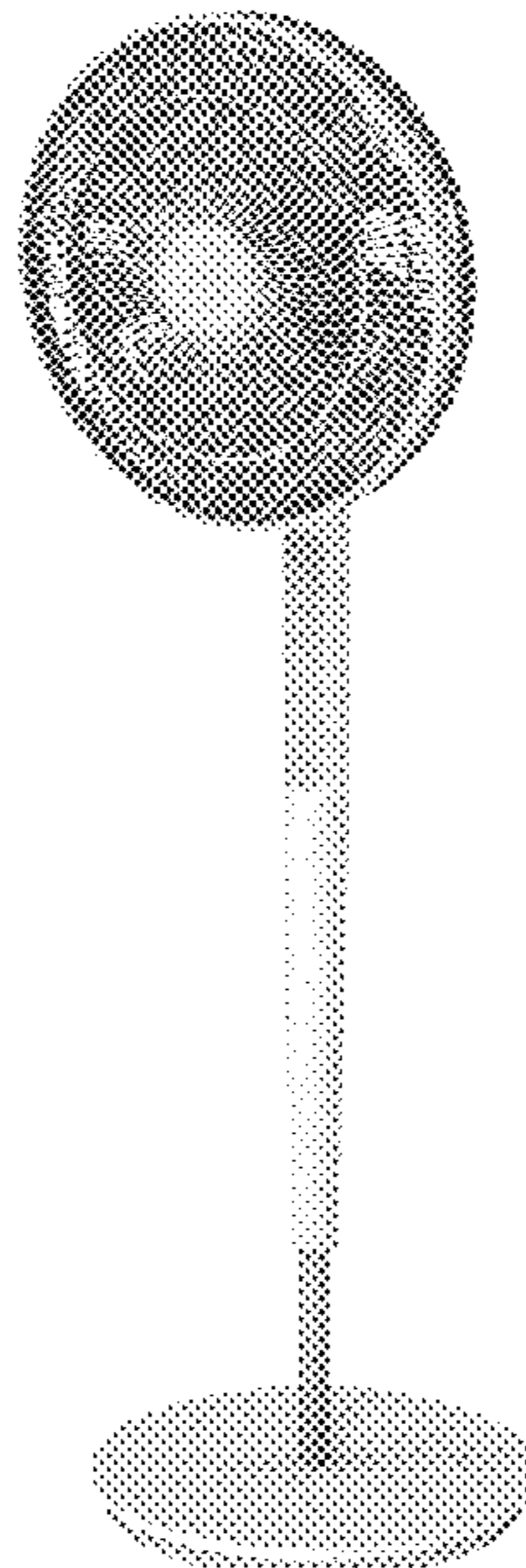

1.1

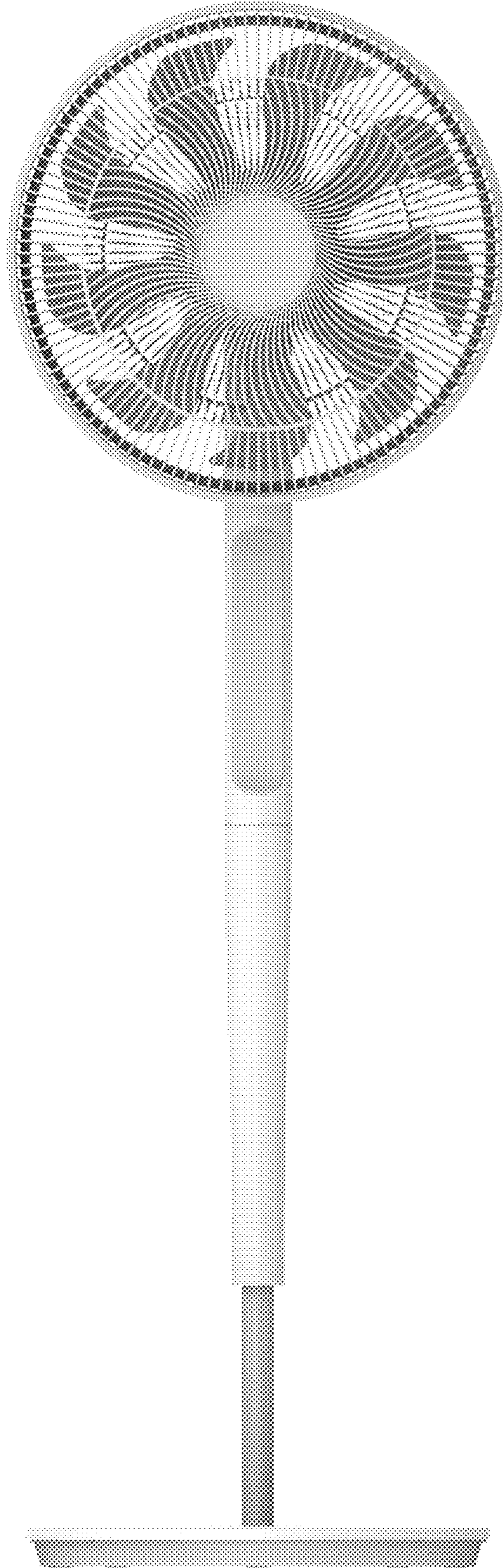

1.2

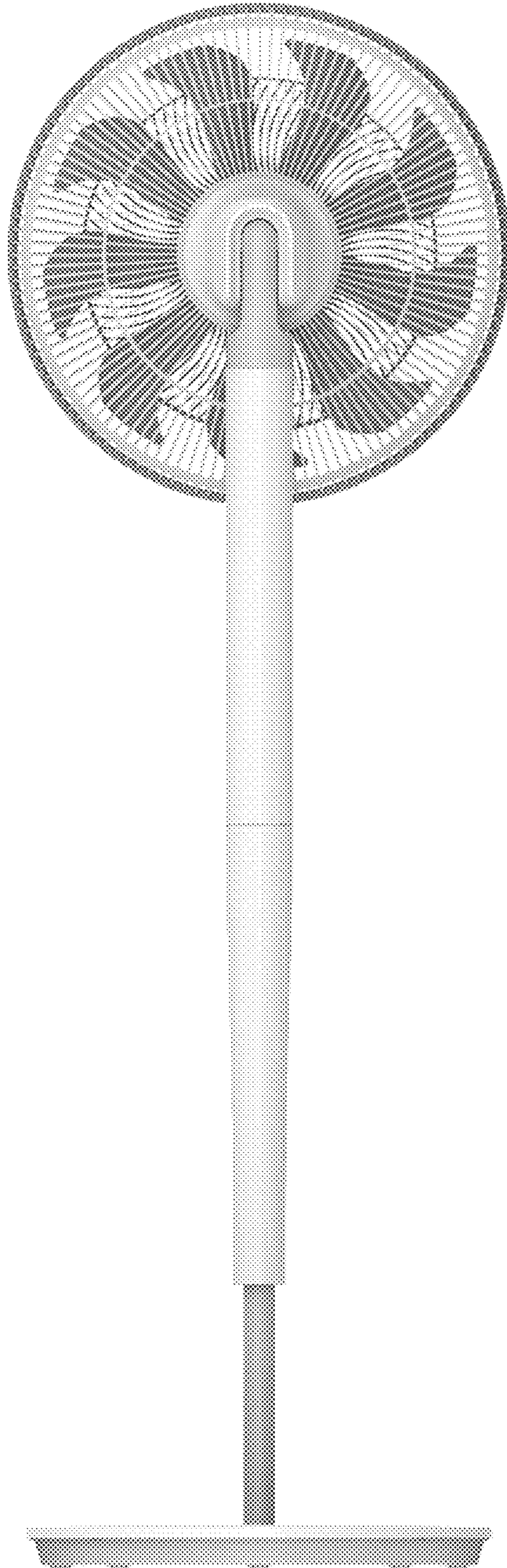

1.3

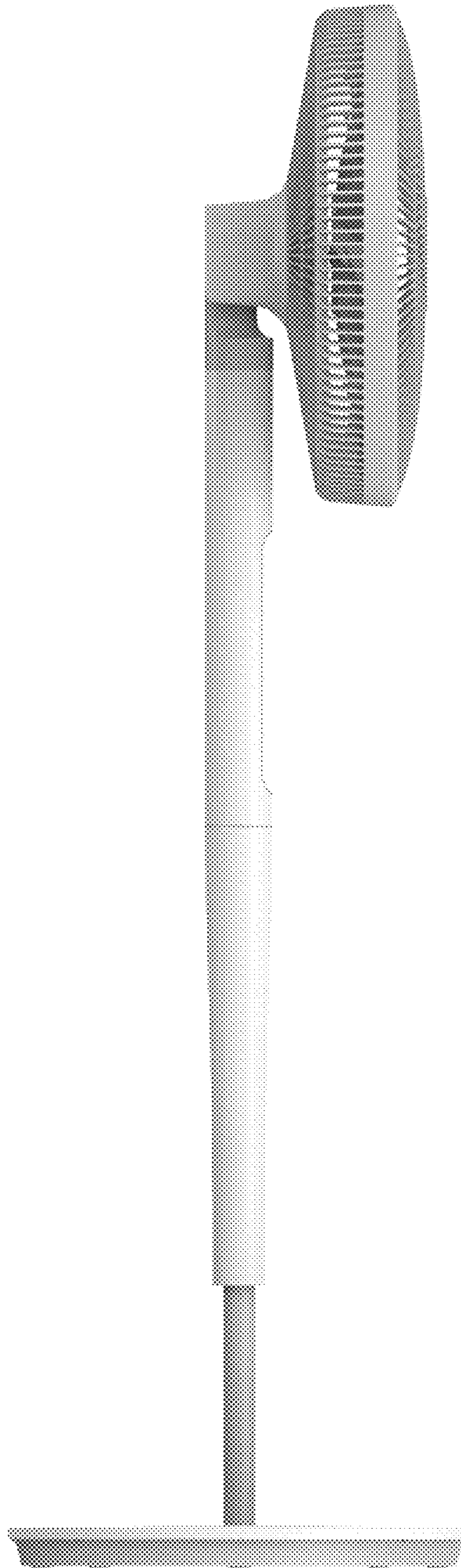

1.4

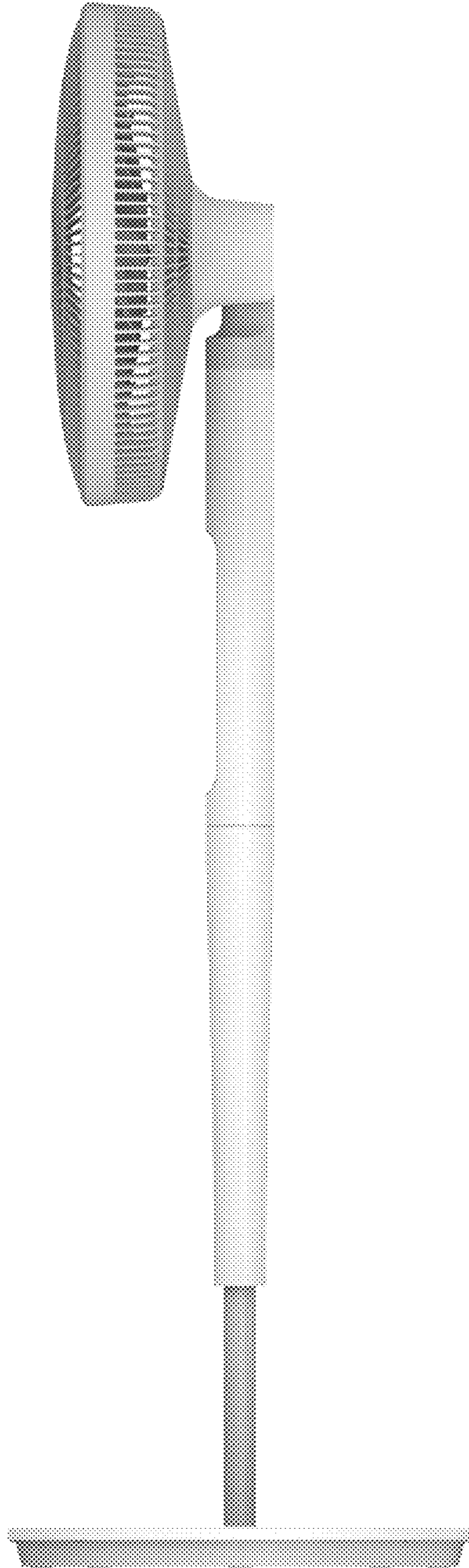

1.5

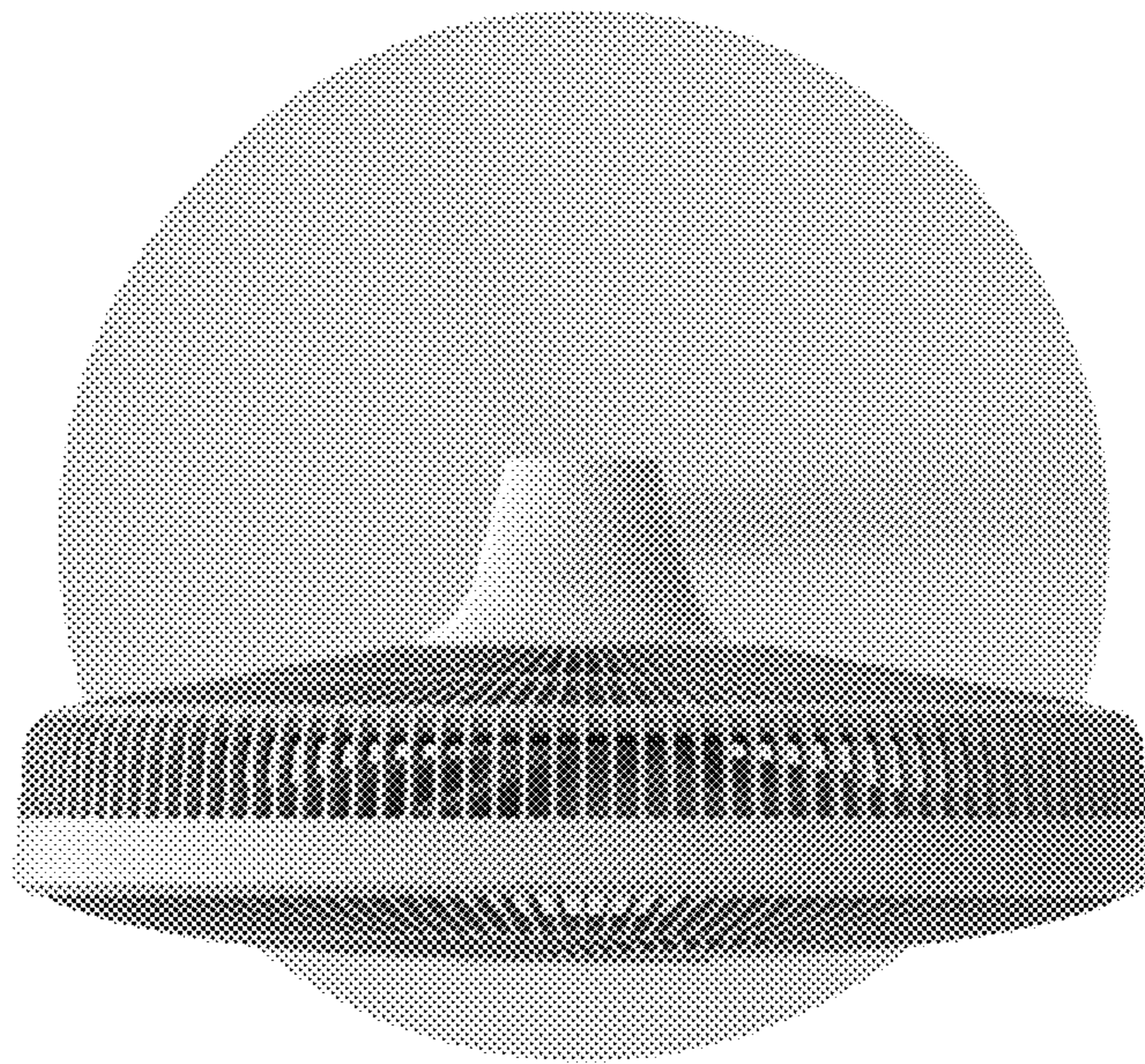

1.6

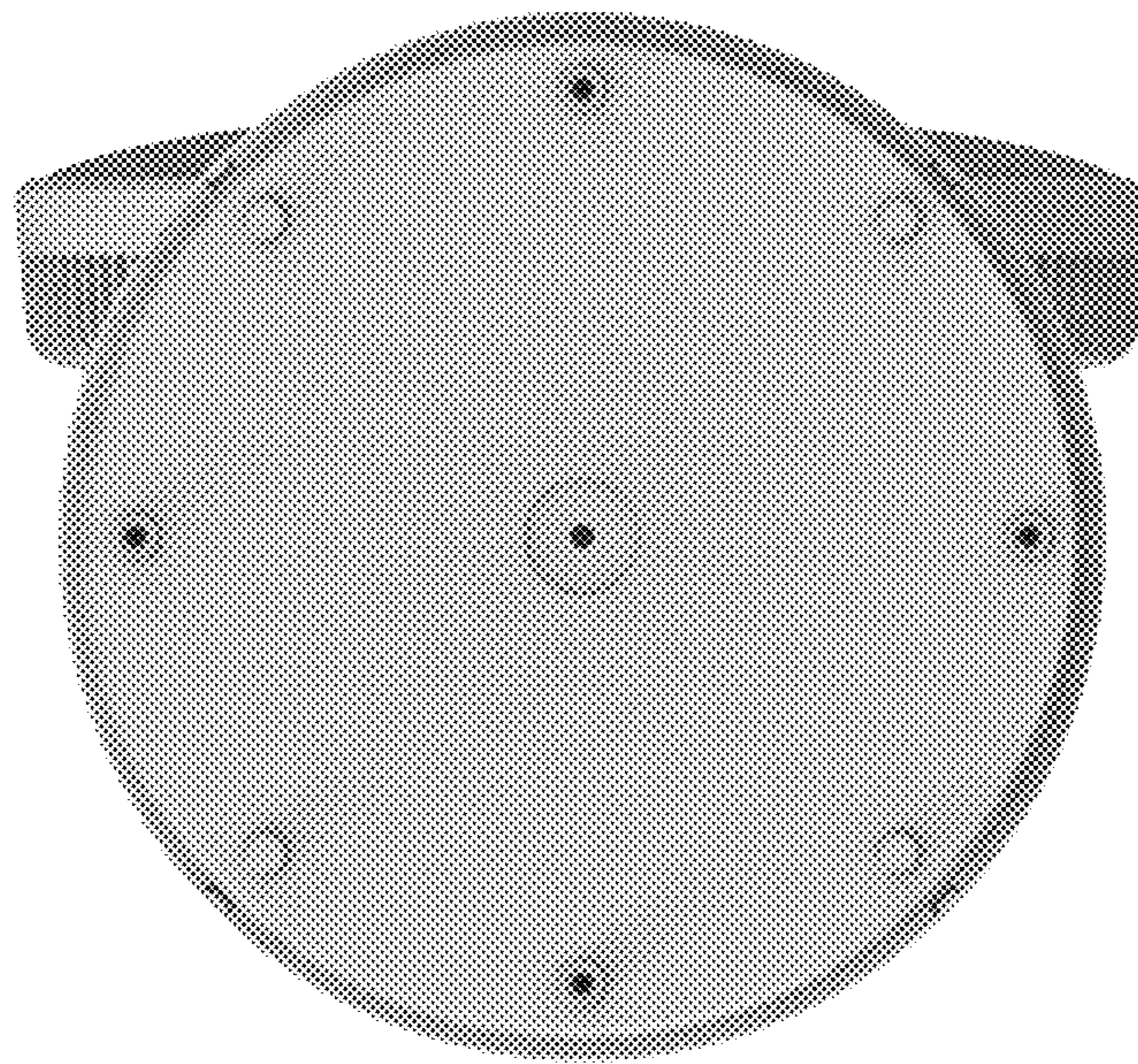

1.7

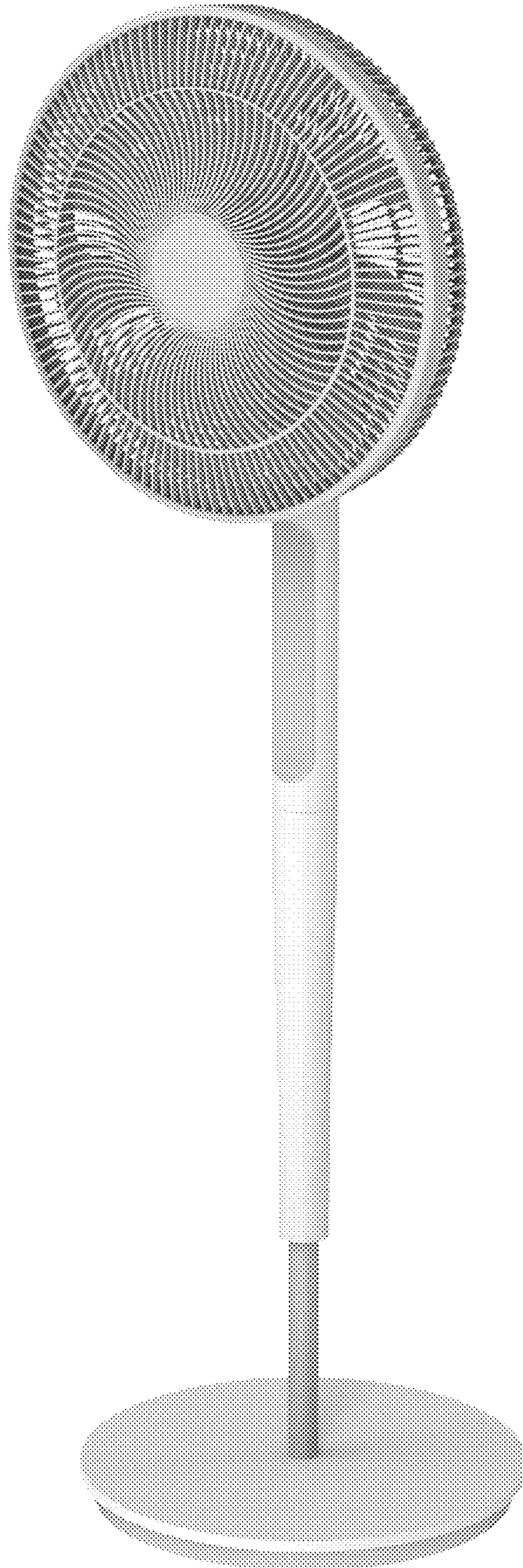

1.8



1.9

