



US00D923766S

(12) **United States Design Patent**  
**Huang et al.**

(10) **Patent No.:** **US D923,766 S**  
(45) **Date of Patent:** **\*\* Jun. 29, 2021**

(54) **HUMIDIFIER**  
(71) Applicant: **RESVENT MEDICAL TECHNOLOGY CO., LTD,**  
Guangdong (CN)  
(72) Inventors: **Gen Huang,** Guangdong (CN);  
**Yonghui Chen,** Guangdong (CN)  
(73) Assignee: **RESVENT MEDICAL TECHNOLOGY CO., LTD,** Shenzhen (CN)

D556,250 S \* 11/2007 Kent ..... D18/34.6  
D601,687 S \* 10/2009 Chan ..... D23/364  
D611,134 S \* 3/2010 Borgi ..... D23/355  
D683,839 S \* 6/2013 Yamashita ..... D23/364  
D725,758 S \* 3/2015 Kim ..... D23/333  
D735,843 S \* 8/2015 Sunwoo ..... D23/333  
D737,944 S \* 9/2015 Shore ..... D23/364  
D748,235 S \* 1/2016 Yamashita ..... D23/364  
D827,115 S \* 8/2018 Petersen ..... D23/333  
D835,713 S \* 12/2018 Xu ..... D18/34.6  
2005/0257689 A1\* 11/2005 Lin ..... A61L 9/14  
96/227

(\*\*) Term: **15 Years**  
(21) Appl. No.: **29/647,840**  
(22) Filed: **May 16, 2018**

(30) **Foreign Application Priority Data**

Nov. 16, 2017 (CN) ..... 201730567296.X

(51) **LOC (13) Cl.** ..... **23-04**

(52) **U.S. Cl.**  
USPC ..... **D23/356**

(58) **Field of Classification Search**  
USPC ..... D23/355–366, 352, 369, 332, 333, 335,  
D23/336, 342, 351; 422/120, 122;  
55/356, 473, 504; 96/97; D14/188, 170,  
D14/172; 261/DIG. 17, DIG. 65,  
261/DIG. 88, DIG. 31  
CPC ..... A61L 9/22; B01D 47/00; B01D 47/027;  
B01D 2221/02; B01D 2259/4508; B03C  
3/368; B03C 3/155; F24F 3/16; F24F  
13/20; F24F 13/28; F24F 2001/0096;  
F24F 3/1405; F24F 3/1603; F24F 13/222  
See application file for complete search history.

(56) **References Cited**

**U.S. PATENT DOCUMENTS**

D465,567 S \* 11/2002 Choi ..... D23/364  
D549,308 S \* 8/2007 Chiu ..... D23/333

**OTHER PUBLICATIONS**

Resvent website, iHope RH10 humidifier, Oct. 19, 2019, <http://www.resvent.com/en/product/291.html> (Year: 2019).\*

\* cited by examiner

*Primary Examiner* — Nathan M Johnston

(57) **CLAIM**

A new, original, ornamental design for a humidifier, as shown and described.

**DESCRIPTION**

FIG. 1 is a front view of a humidifier bearing the design;  
FIG. 2 is a back view thereof;  
FIG. 3 is a top view thereof;  
FIG. 4 is a bottom view thereof;  
FIG. 5 is a right side view thereof;  
FIG. 6 is a left side view thereof;  
FIG. 7 is a top, front, right perspective view thereof; and,  
FIG. 8 is a top, front, right perspective view thereof in an unassembled state.

The broken lines in the drawings form no part of the claimed design.

**1 Claim, 4 Drawing Sheets**

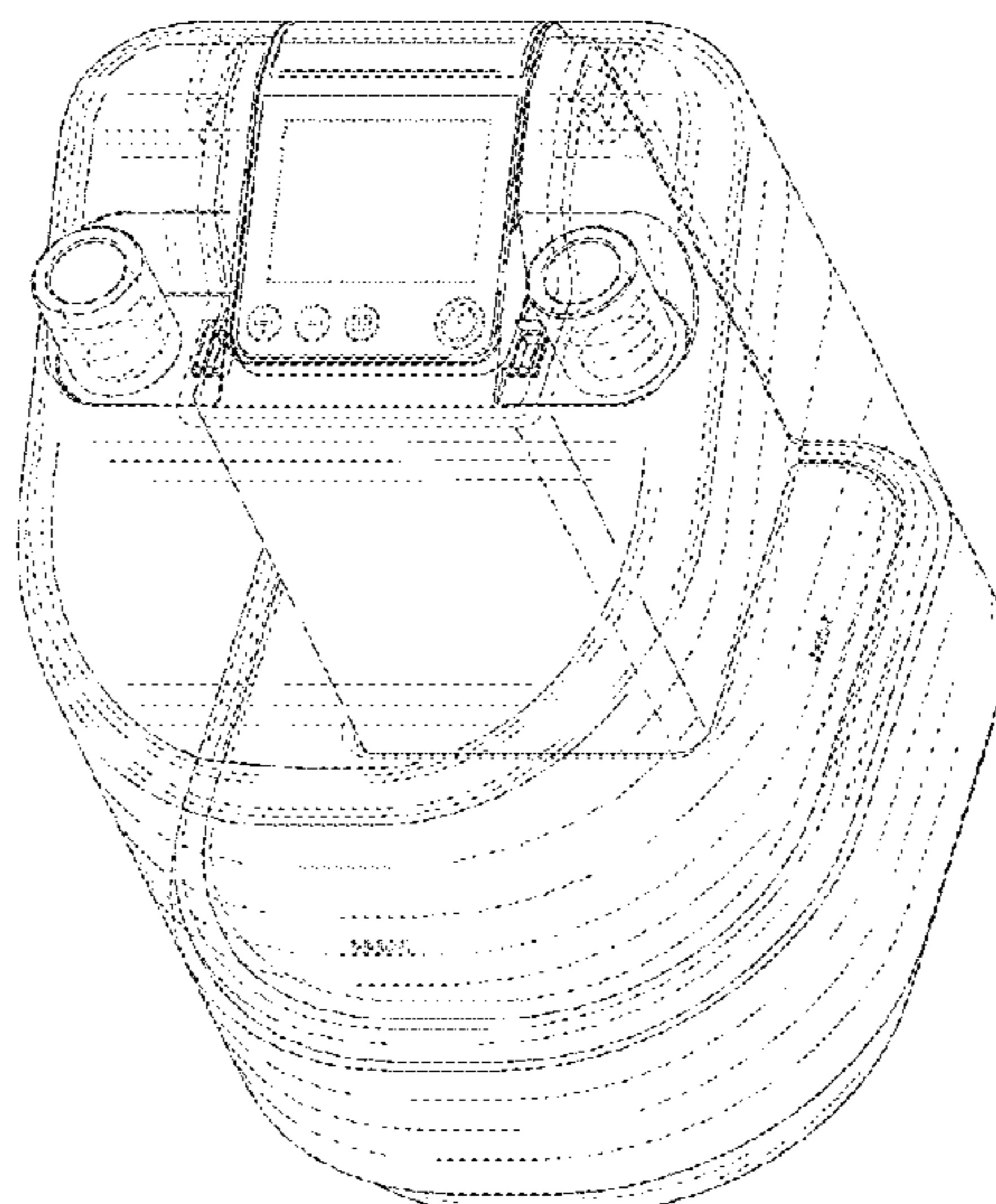

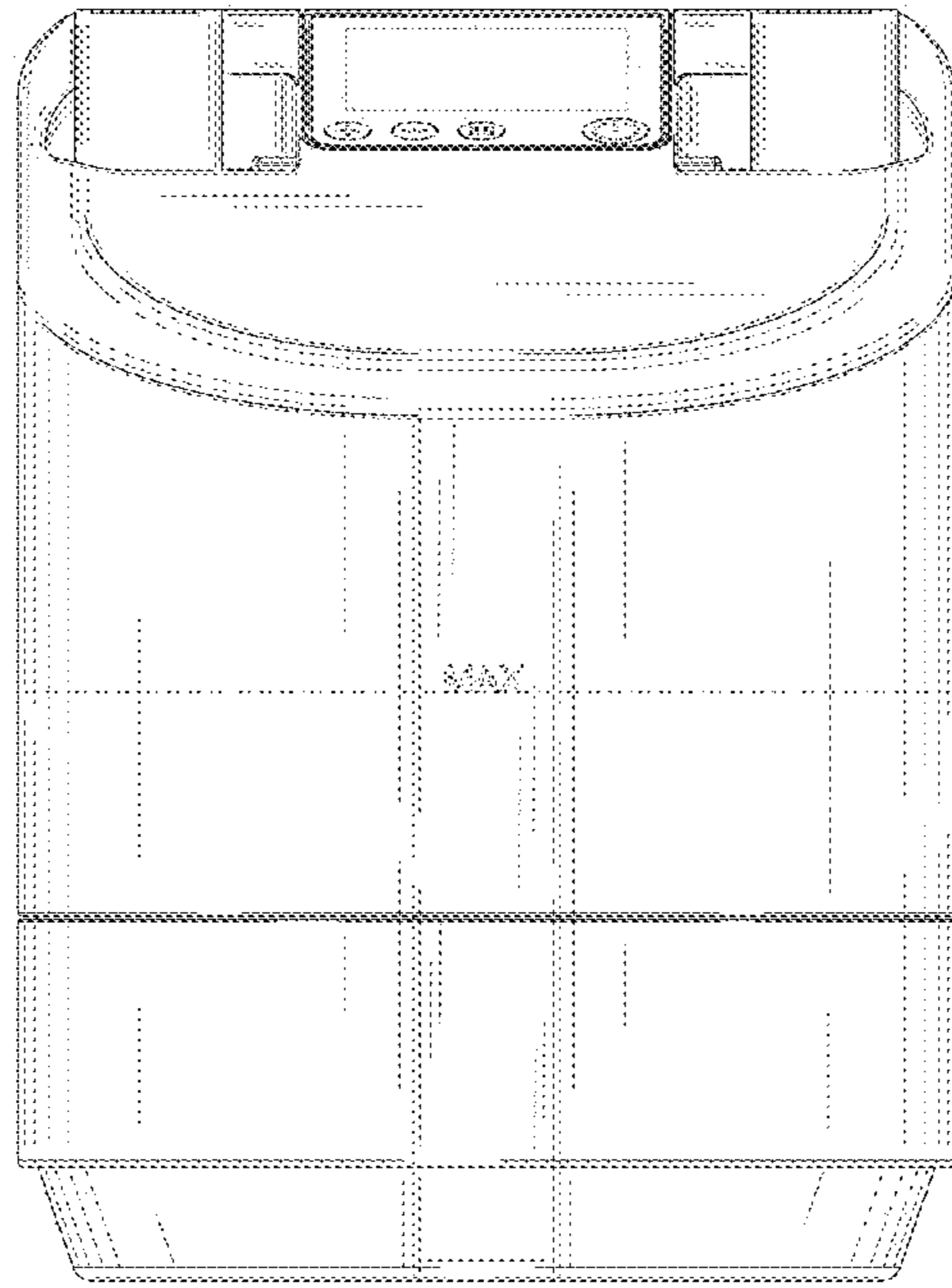

fig. 1

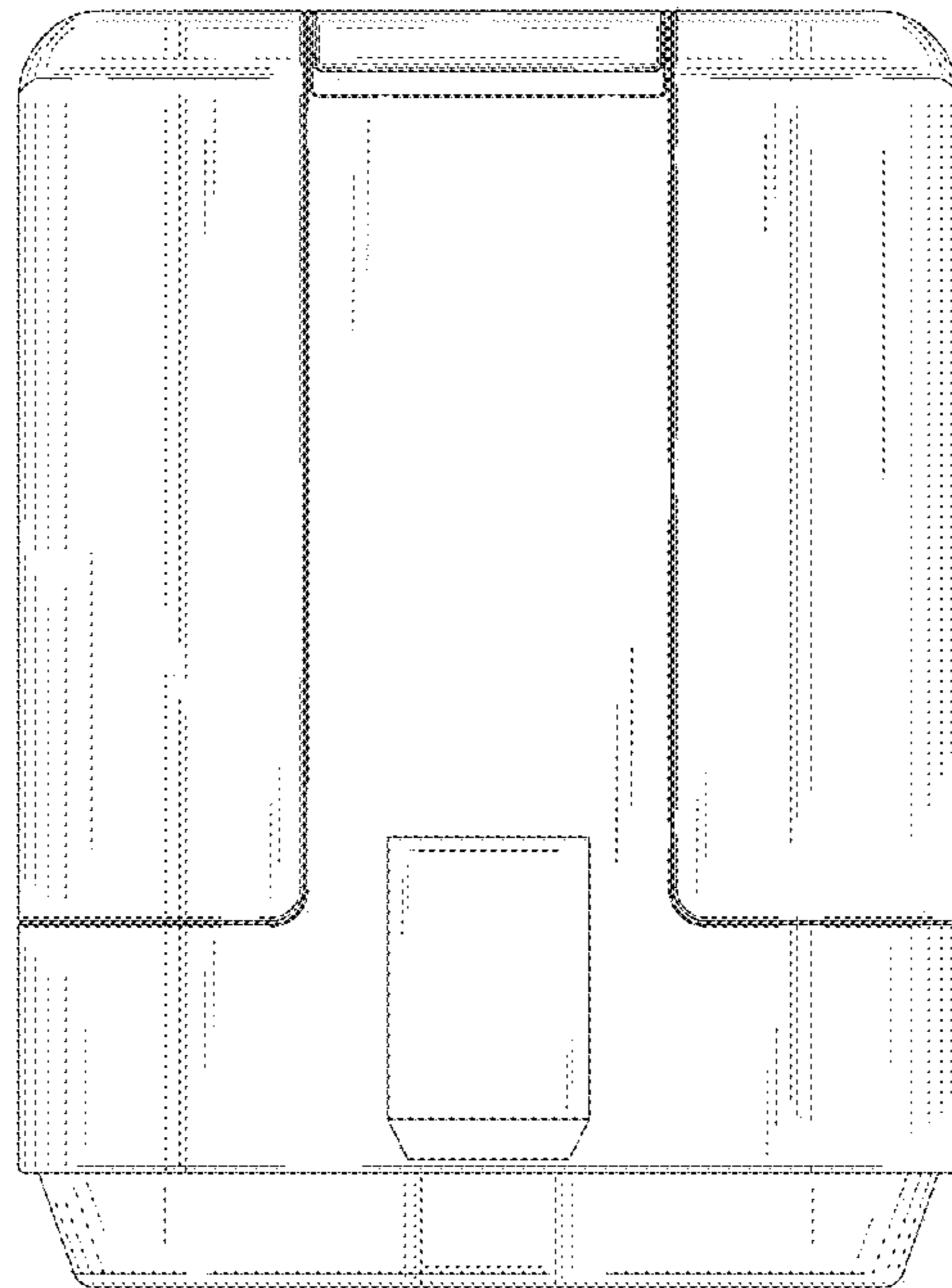

fig. 2

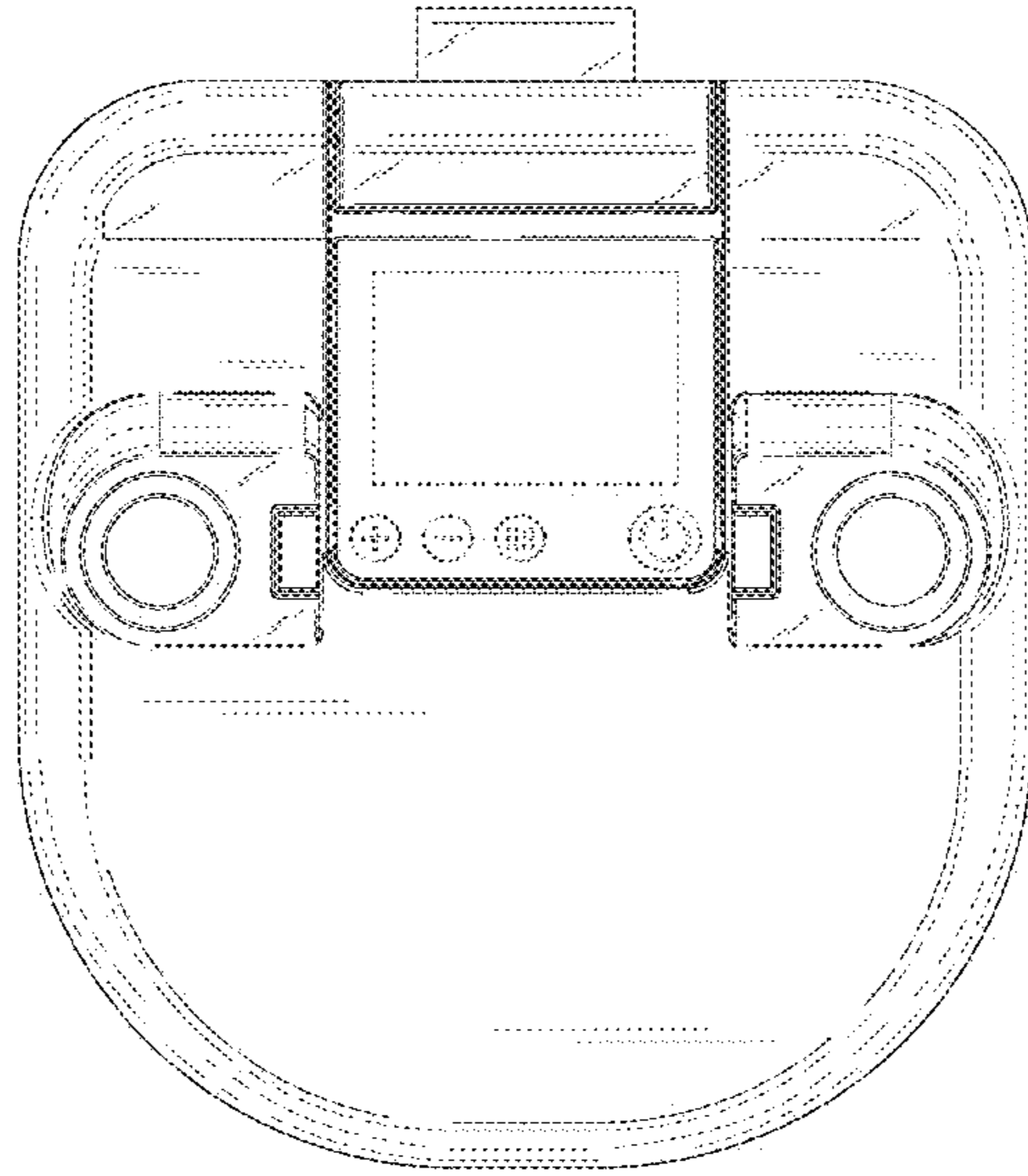

fig.3

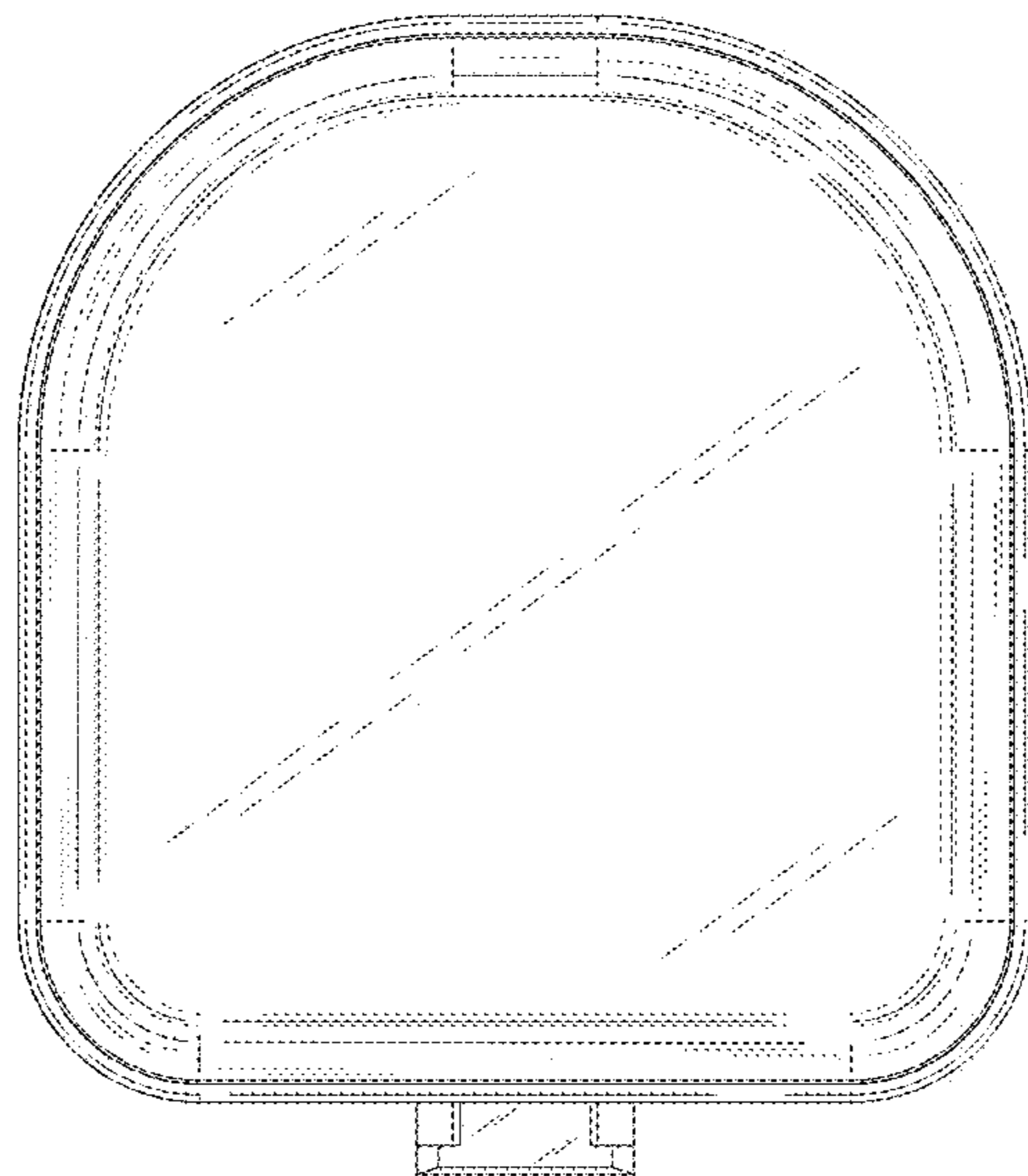

fig.4

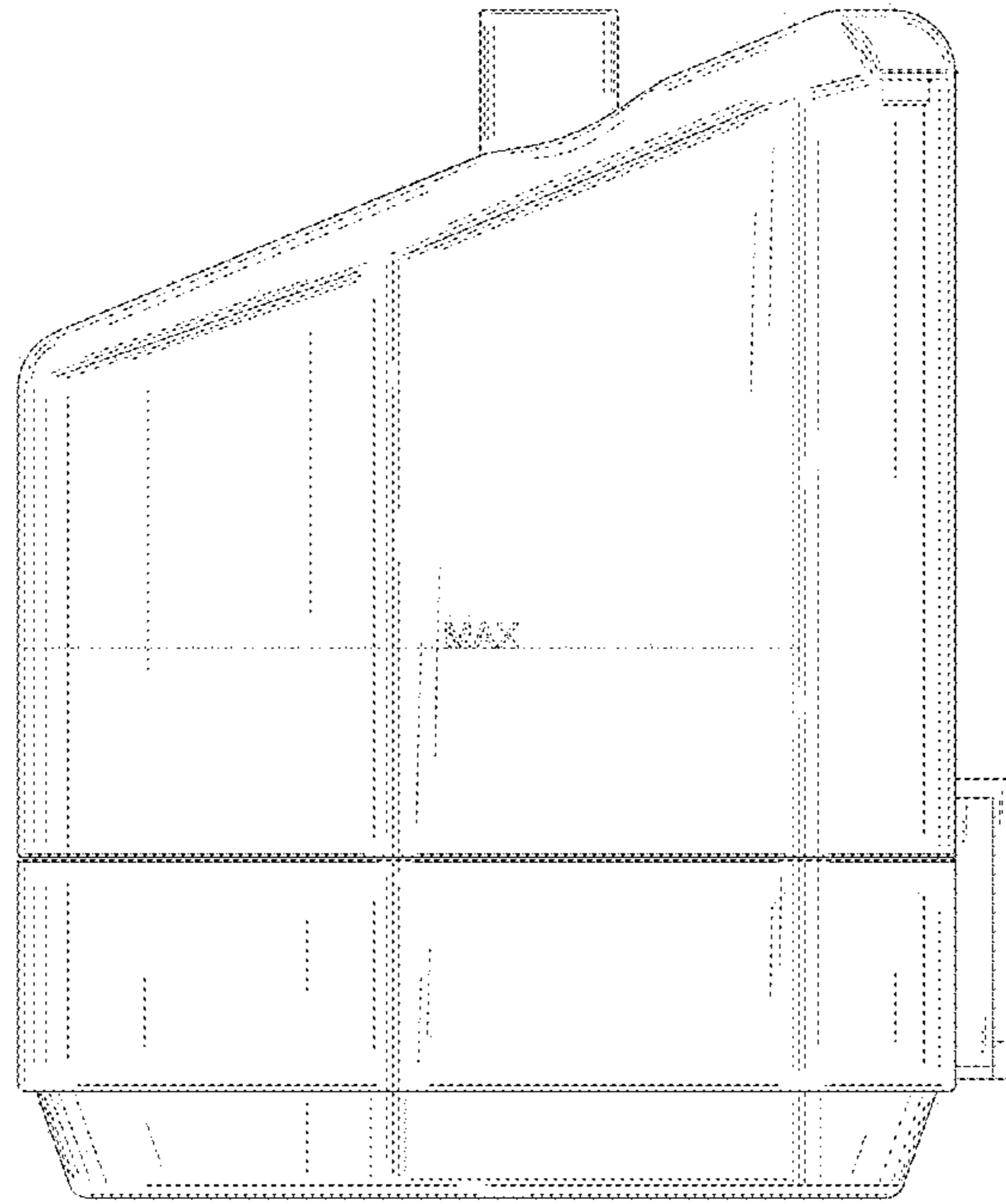

fig.5

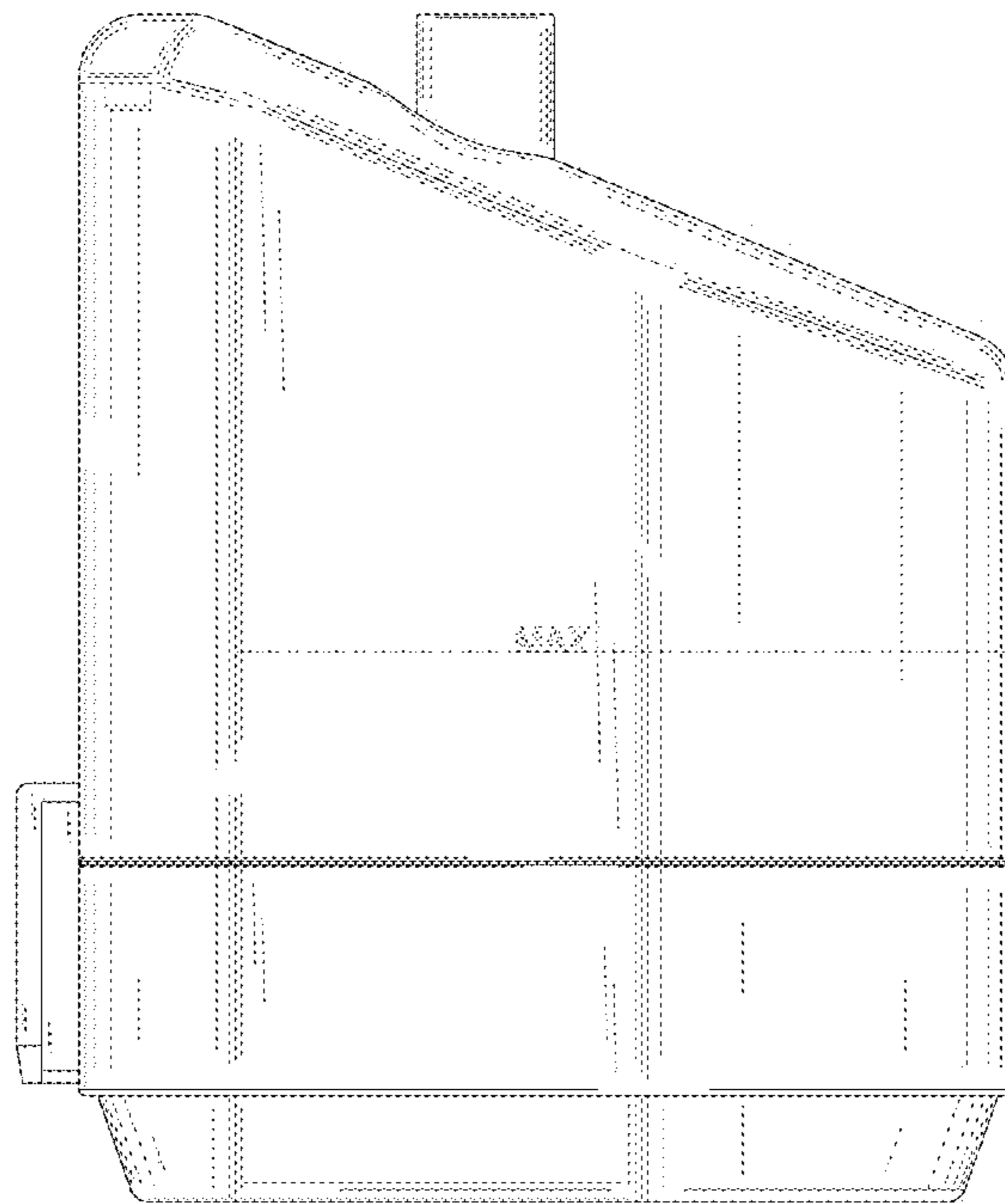

fig.6

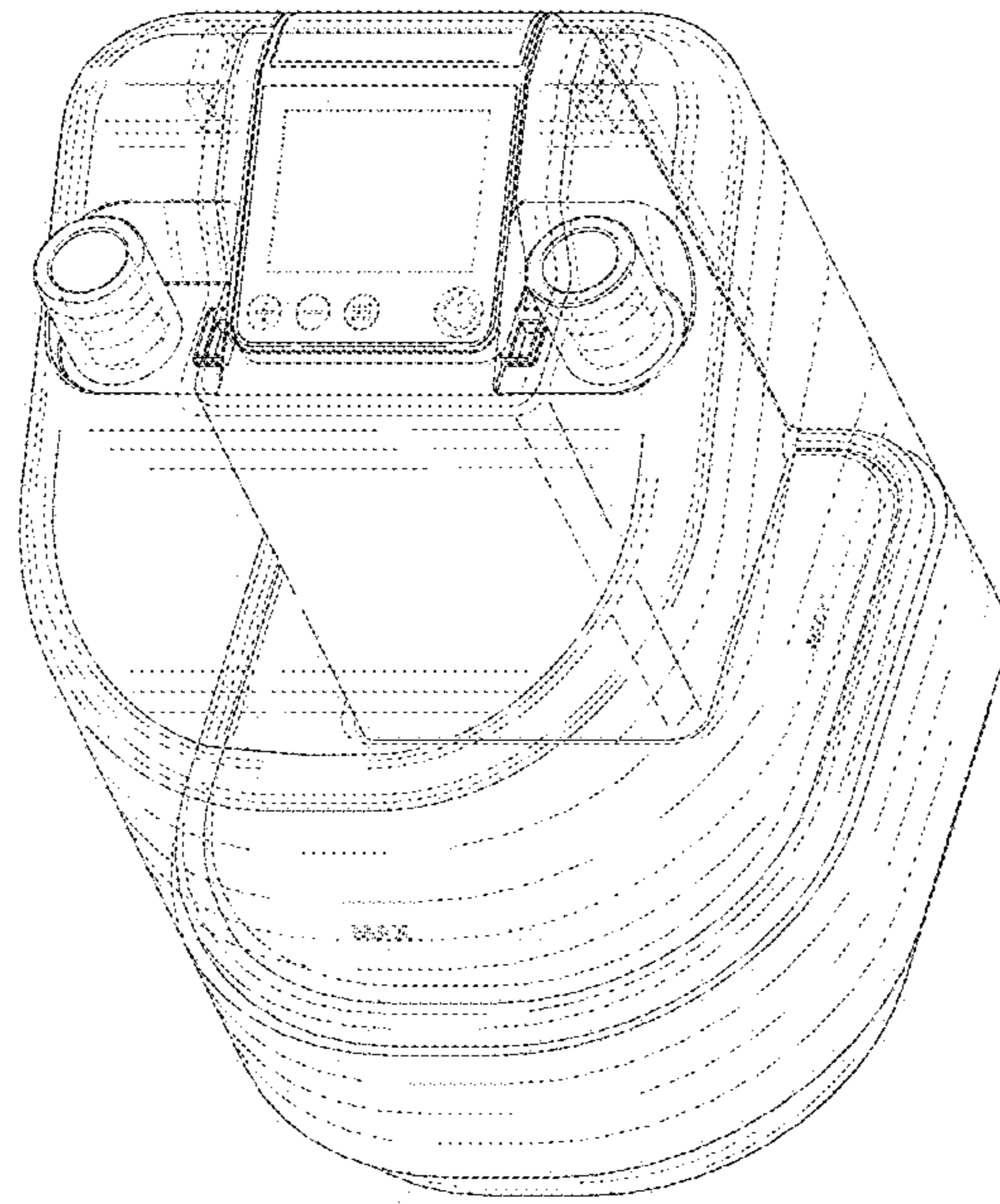

fig. 7

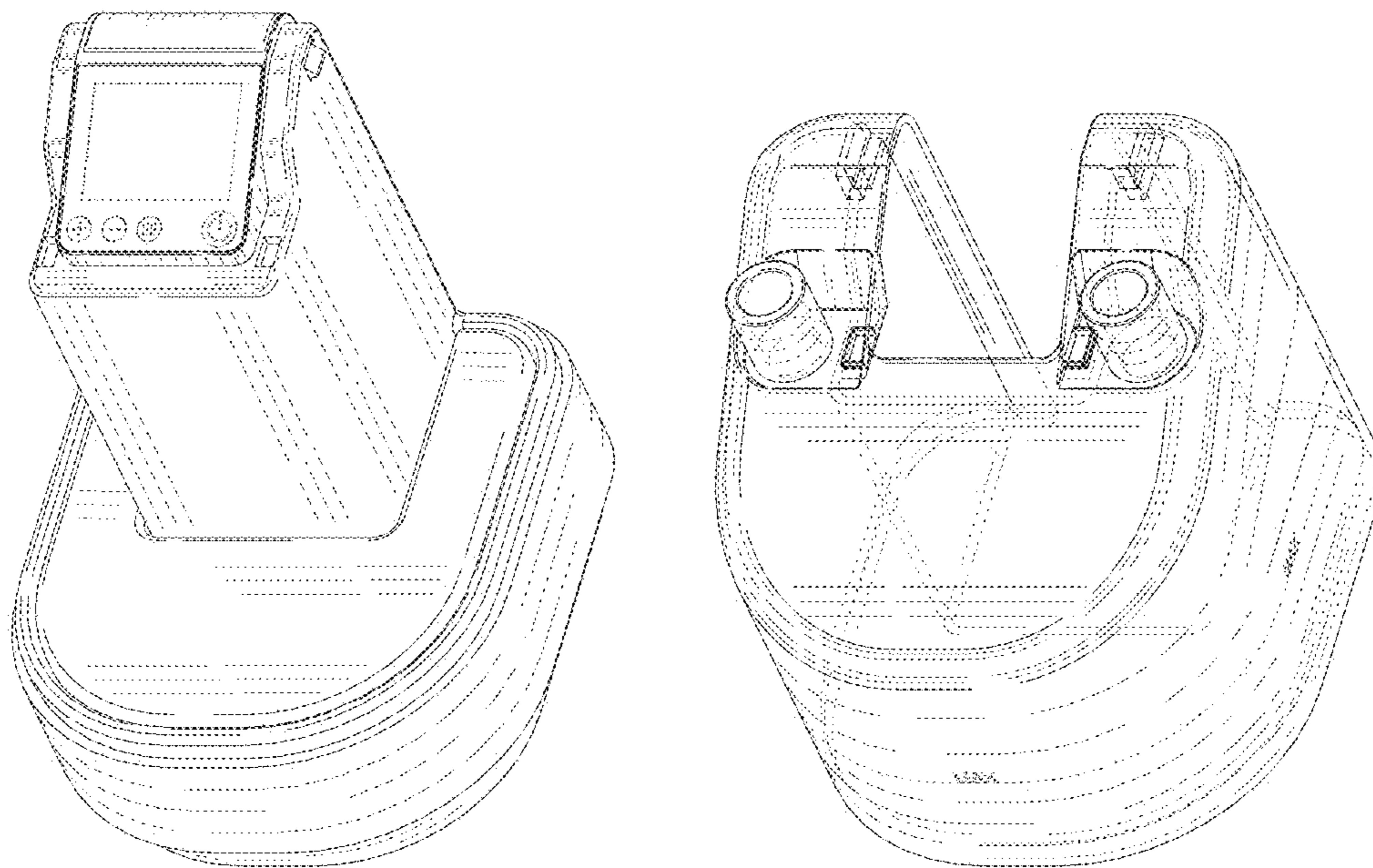

fig. 8