



US00D923707S

(12) **United States Design Patent**
Hu

(10) **Patent No.:** **US D923,707 S**

(45) **Date of Patent:** **** Jun. 29, 2021**

(54) **FILE SORTER**

(71) Applicant: **Yajun Hu**, El Dorado Hills, CA (US)

(72) Inventor: **Yajun Hu**, El Dorado Hills, CA (US)

(73) Assignees: **Yajun Hu**, Moreau, CT (US);
EUREKA LLC., El Dorado Hills, CA (US)

(**) Term: **15 Years**

(21) Appl. No.: **29/709,579**

(22) Filed: **Oct. 15, 2019**

(51) **LOC (13) Cl.** **19-02**

(52) **U.S. Cl.**
USPC **D19/92**

(58) **Field of Classification Search**
USPC D19/75, 77-78, 86-87, 90-92; D3/306,
D3/309, 310, 312; D6/675.2, 675.4, 683
CPC ... A47B 63/00; B42F 7/06; B42F 7/08; B42F
7/10; B42F 7/12; B42F 7/14; B42F
7/145; B42F 17/02; B42F 17/08; B42F
17/12; B65D 7/20; B65D 7/26; B65D
7/30

See application file for complete search history.

(56) **References Cited**

U.S. PATENT DOCUMENTS

- 3,435,958 A * 4/1969 Chesley A47F 5/13
211/133.2
- D321,609 S * 11/1991 Dardashti D6/675.2
- 5,140,724 A 8/1992 Crisanti
- D330,047 S 10/1992 Evenson
- D332,647 S * 1/1993 Johnson D21/671
- D335,560 S * 5/1993 Fennell, Jr. D19/92

- D336,927 S 6/1993 Samuels et al.
- D426,576 S * 6/2000 Bruner D19/78
- D433,711 S * 11/2000 Andujar D19/75
- D520,002 S 5/2006 Mello
- D534,374 S * 1/2007 Wright D6/566
- D550,284 S 9/2007 Goodman et al.
- D577,513 S * 9/2008 Walker D6/675.5
- D579,691 S * 11/2008 Snider D6/675.2
- D604,769 S 11/2009 Chen et al.
- 7,921,998 B2 4/2011 Schenker
- D644,491 S * 9/2011 Snider D7/600.1
- D665,846 S 8/2012 Chuang
- D691,659 S 10/2013 Hu
- D719,610 S * 12/2014 Tsai D19/90
- D756,458 S * 5/2016 Tsai D19/90
- 9,782,996 B1 * 10/2017 Kuo B42F 7/12
- D841,091 S * 2/2019 Tuang D19/92
- D841,734 S * 2/2019 Tuang D19/90
- D856,420 S * 8/2019 Tsai D19/92
- D857,094 S * 8/2019 Tsai D19/90
- D904,516 S * 12/2020 Tsai D19/92

* cited by examiner

Primary Examiner — Elizabeth A. Albert

(57) **CLAIM**

The ornamental design for a file sorter, as shown and described.

DESCRIPTION

FIG. 1 is a perspective view of file sorter showing my design;

FIG. 2 is a front view thereof;

FIG. 3 is a bottom view thereof;

FIG. 4 is a top view thereof;

FIG. 5 is a rear side view thereof;

FIG. 6 is a left side view thereof; and,

FIG. 7 is a right side view thereof.

1 Claim, 7 Drawing Sheets

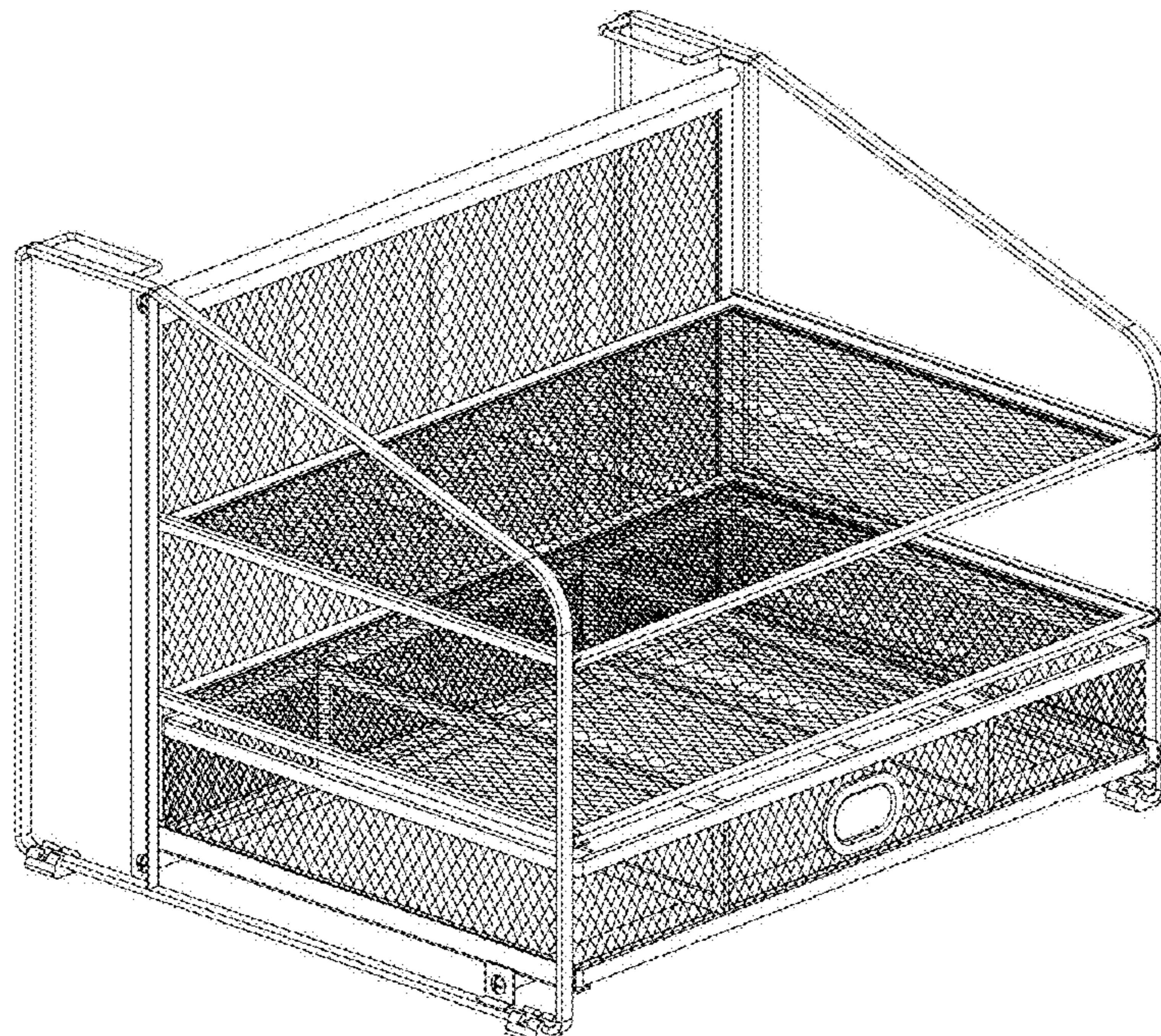

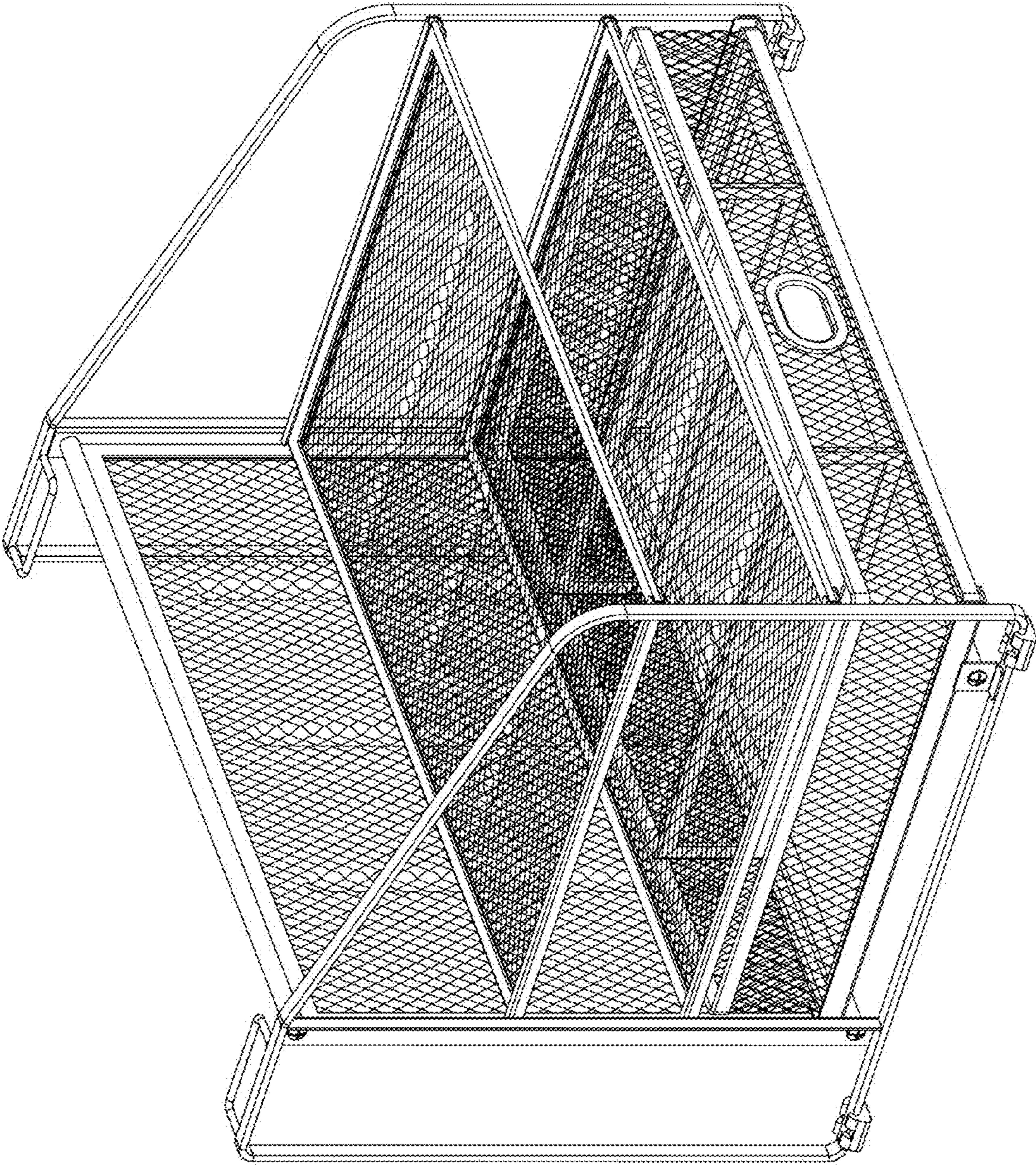

FIG.1

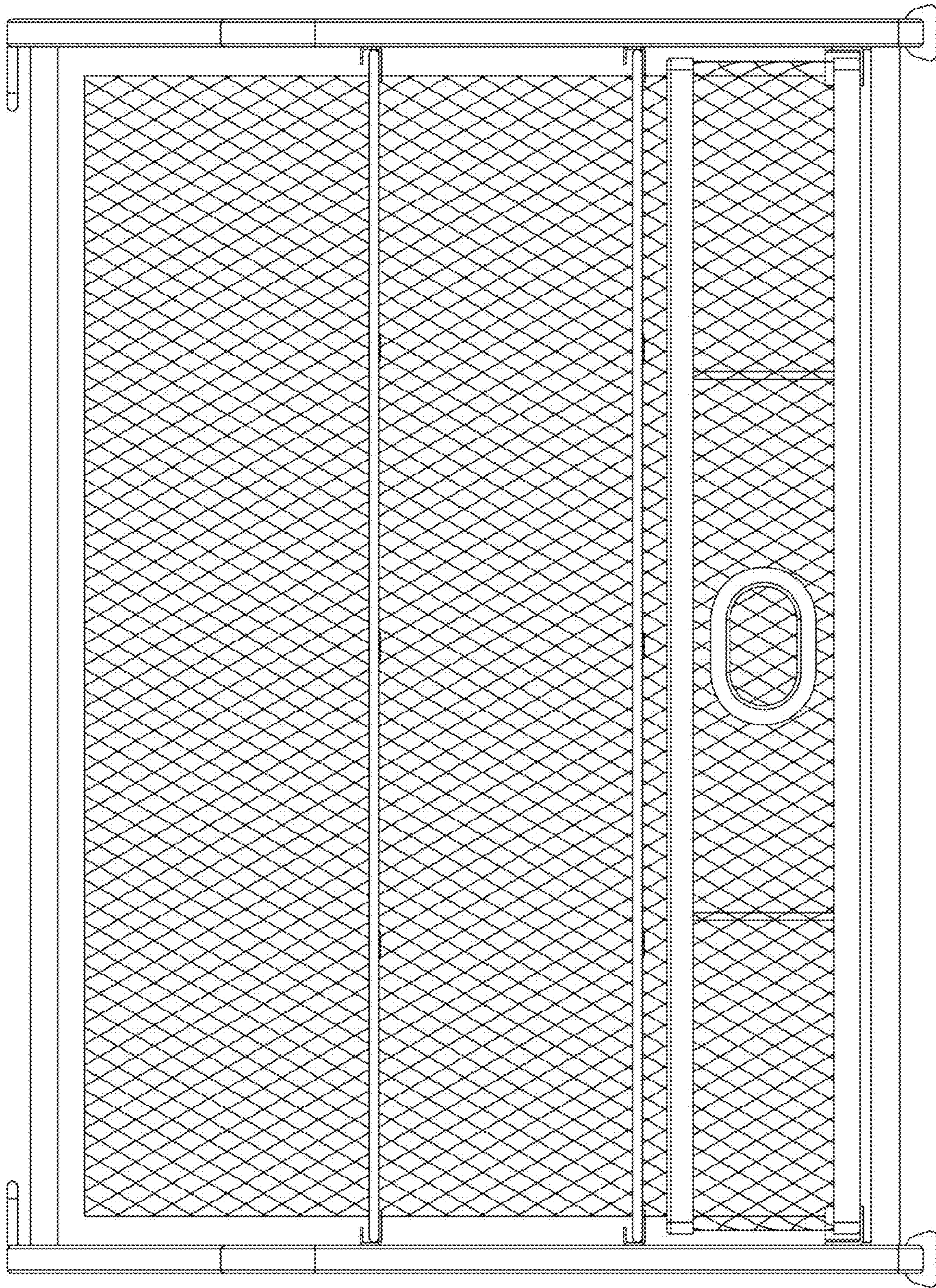

FIG.2

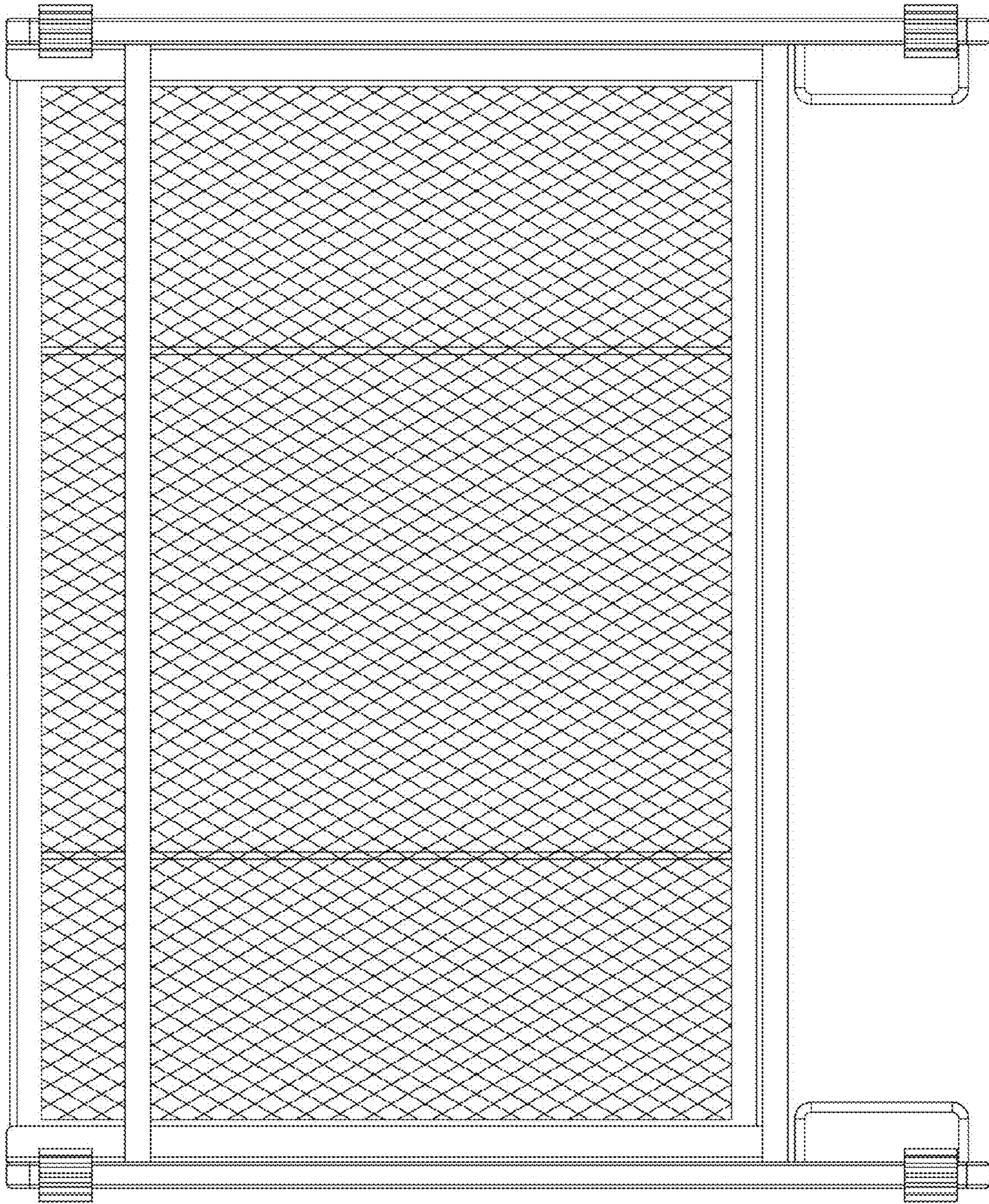

FIG.3

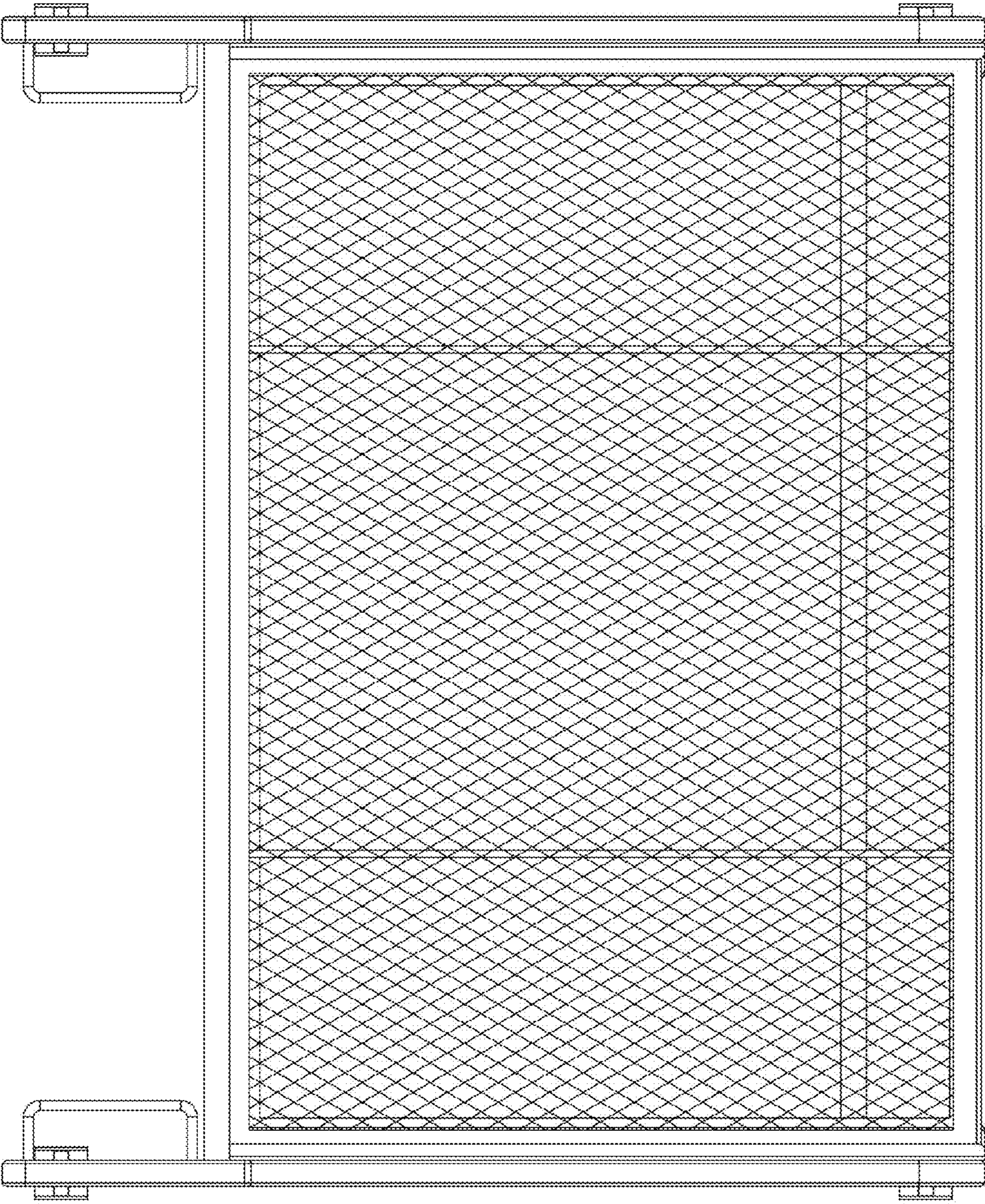

FIG.4

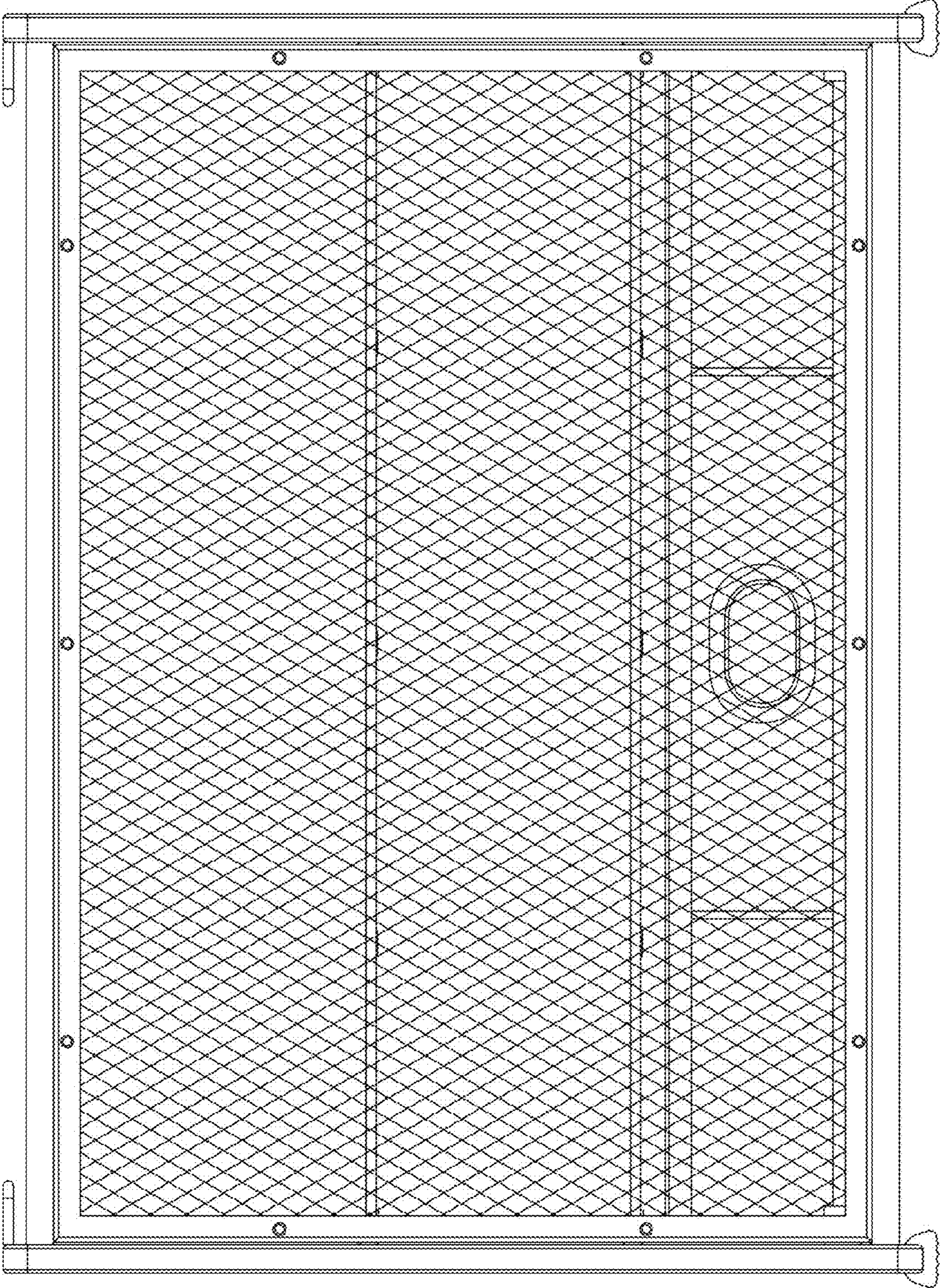

FIG.5

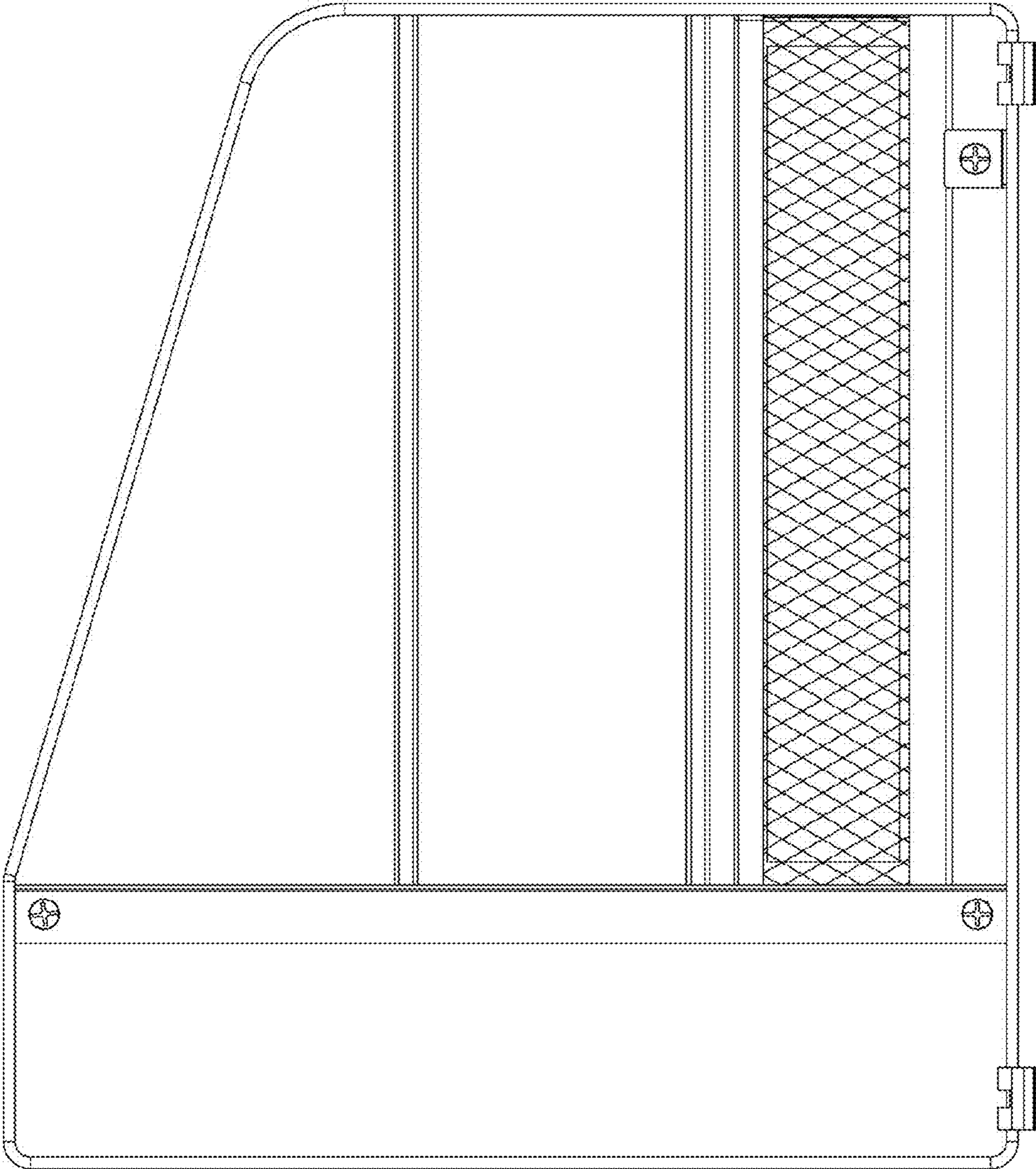

FIG.6

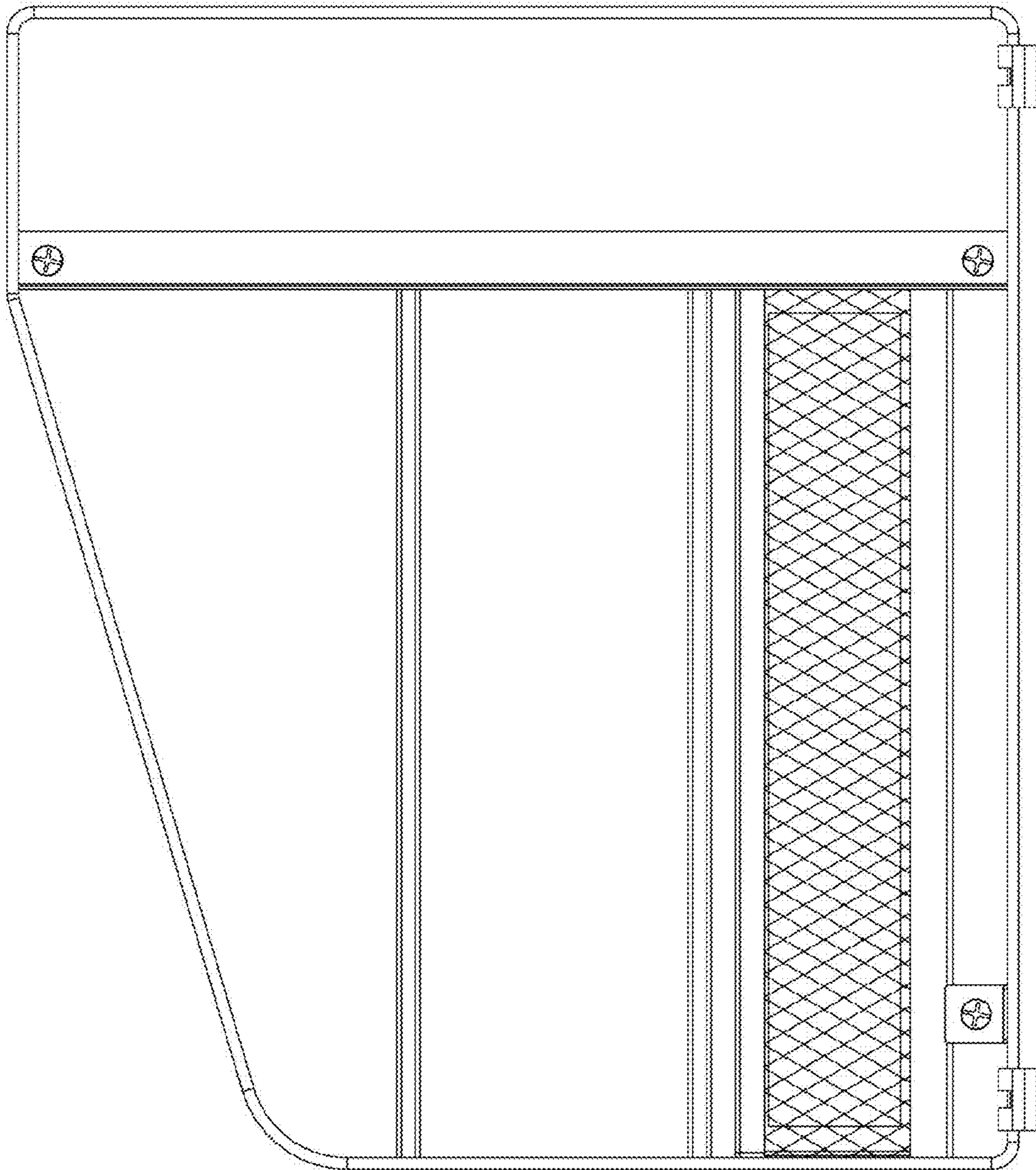

FIG.7