



US00D923546S

(12) **United States Design Patent** (10) **Patent No.:** **US D923,546 S**
Biancalana et al. (45) **Date of Patent:** **** Jun. 29, 2021**

(54) **VEHICLE WHEEL RIM**
(71) Applicant: **FERRARI S.p.A.**, Modena (IT)
(72) Inventors: **Matteo Biancalana**, Modena (IT);
Flavio Manzoni, Maranello (IT)
(73) Assignee: **FERRARI S.p.A.**, Modena (IT)
(**) Term: **15 Years**

D756,878 S * 5/2016 Valencia Pollex D12/209
D759,564 S * 6/2016 Valencia Pollex D12/209
D788,003 S * 5/2017 Conforzi D12/209
D791,668 S * 7/2017 Murase D12/209
D806,629 S * 1/2018 Bridan D12/211
D815,009 S * 4/2018 Valencia Pollex D12/209
D826,130 S * 8/2018 Myrberg D12/209
D826,826 S * 8/2018 Back D12/209
D855,536 S * 8/2019 Zhao D12/209
D892,014 S * 8/2020 Cenana D12/209

(Continued)

(21) Appl. No.: **35/507,740**
(22) Filed: **May 9, 2019**

Primary Examiner — Darlington Ly
(74) *Attorney, Agent, or Firm* — Cowan, Liebowitz &
Latman, P.C.; Anastasia Zhadina

(80) **Hague Agreement Data**
Int. Filing Date: **May 9, 2019**
Int. Reg. No.: **DM/203497**
Int. Reg. Date: **May 9, 2019**
Int. Reg. Pub. Date: **Nov. 15, 2019**

(57) **CLAIM**

The ornamental design for a vehicle wheel rim, as shown and described.

(30) **Foreign Application Priority Data**

Nov. 9, 2018 (EM) 005821550

(51) **LOC (13) Cl.** **12-16**

(52) **U.S. Cl.**
USPC **D12/211; D12/209**

(58) **Field of Classification Search**
USPC D12/204–213
CPC B60B 1/00; B60B 1/08; B60B 1/10; B60B
1/12; B60B 3/04; B60B 3/06; B60B 3/10;
B60B 3/02; B60B 7/00; B60B 7/01;
B60B 7/02; B60B 7/04; B60B 7/06
See application file for complete search history.

DESCRIPTION

1.-4. Vehicle wheel rim
1.1 is a front perspective view of a vehicle wheel rim showing our new design in accordance to first embodiment;
1.2 is a front elevation view thereof;
1.3 is a rear elevation view thereof;
1.4 is a right side elevation view thereof;
1.5 is a left side elevation view thereof;
1.6 is a top plan view thereof;
1.7 is a bottom plan view thereof;
4.1 is a front perspective view of a vehicle wheel rim showing our new design in accordance to a second embodiment;
4.2 is a front elevation view thereof;
4.3 is a rear elevation view thereof;
4.4 is a right side elevation view thereof;
4.5 is a left side elevation view thereof;
4.6 is a top plan view thereof; and
4.7 is a bottom plan view thereof.
The broken lines in the reproductions illustrate portions of the vehicle wheel rim that form no part of the claimed design.

(56) **References Cited**
U.S. PATENT DOCUMENTS

D660,767 S * 5/2012 von Holzhausen D12/209
D730,799 S * 6/2015 Hans D12/209
D746,212 S * 12/2015 Valencia Pollex D12/211
D747,676 S * 1/2016 Chung D12/211

1 Claim, 14 Drawing Sheets

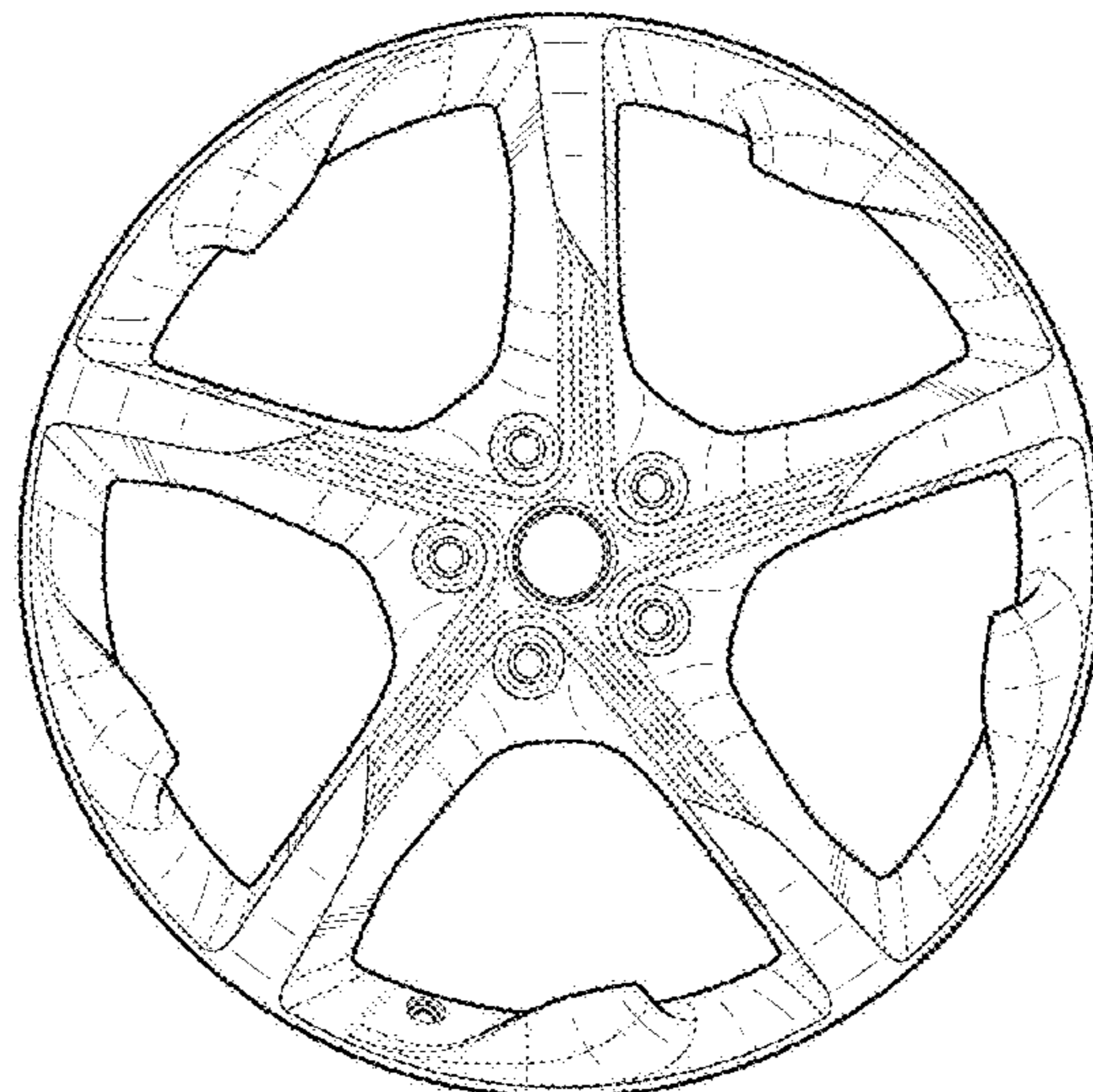

(56)

References Cited

U.S. PATENT DOCUMENTS

D893,382 S * 8/2020 Tanaka D12/209
D894,810 S * 9/2020 Rosello Visa D12/209
2020/0147997 A1* 5/2020 Biancalana B60B 19/10

* cited by examiner

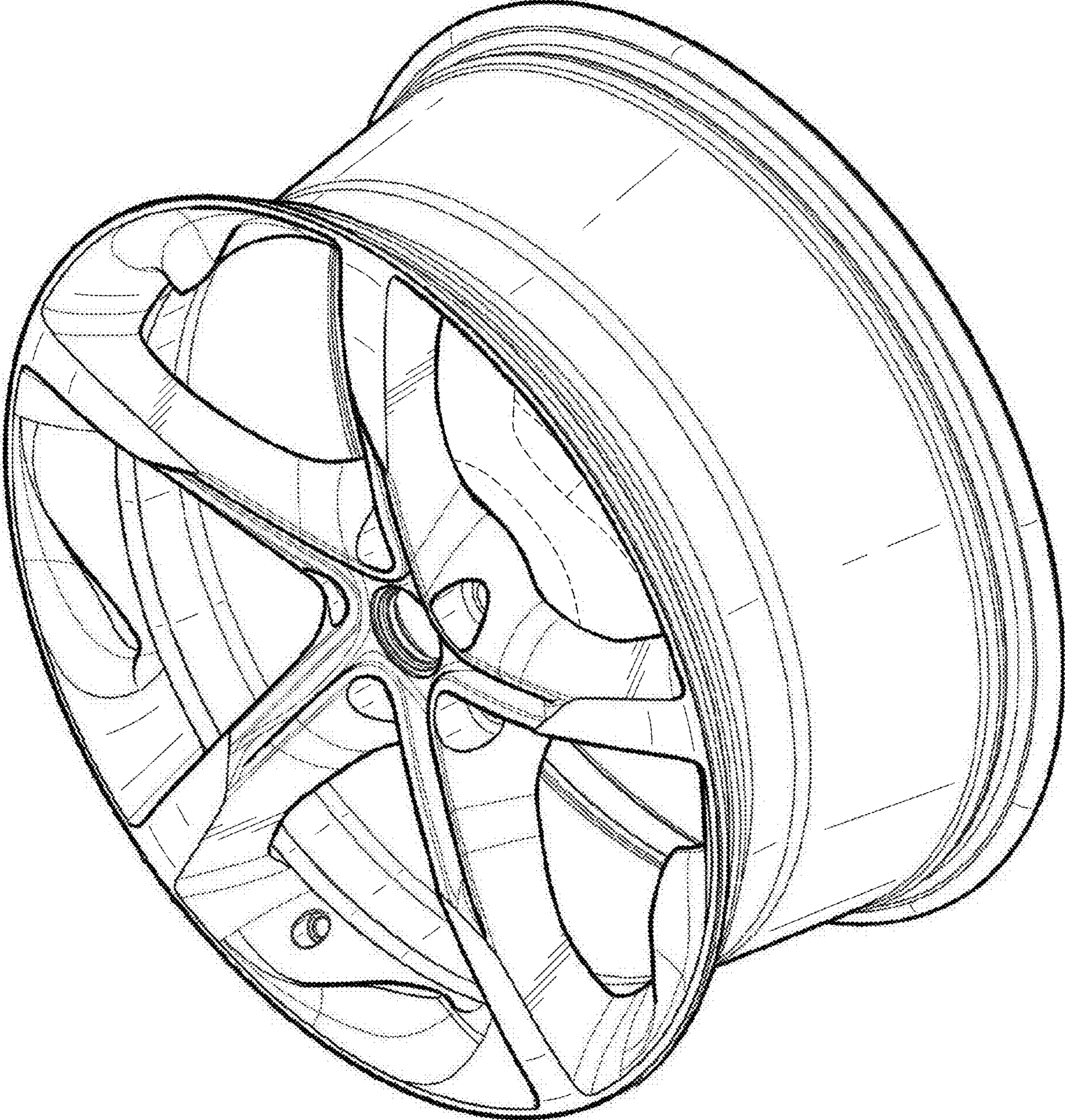

1.1

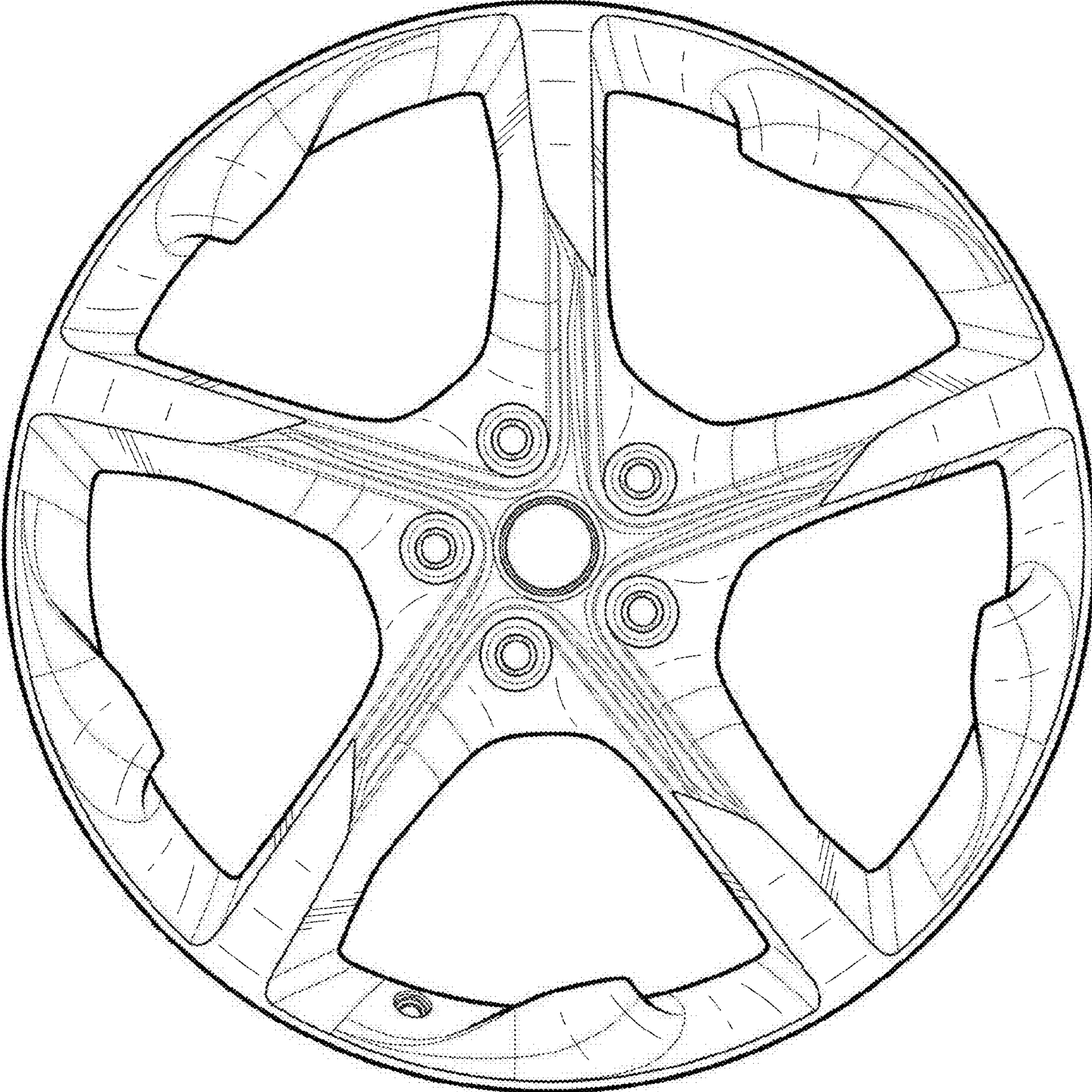

1.2

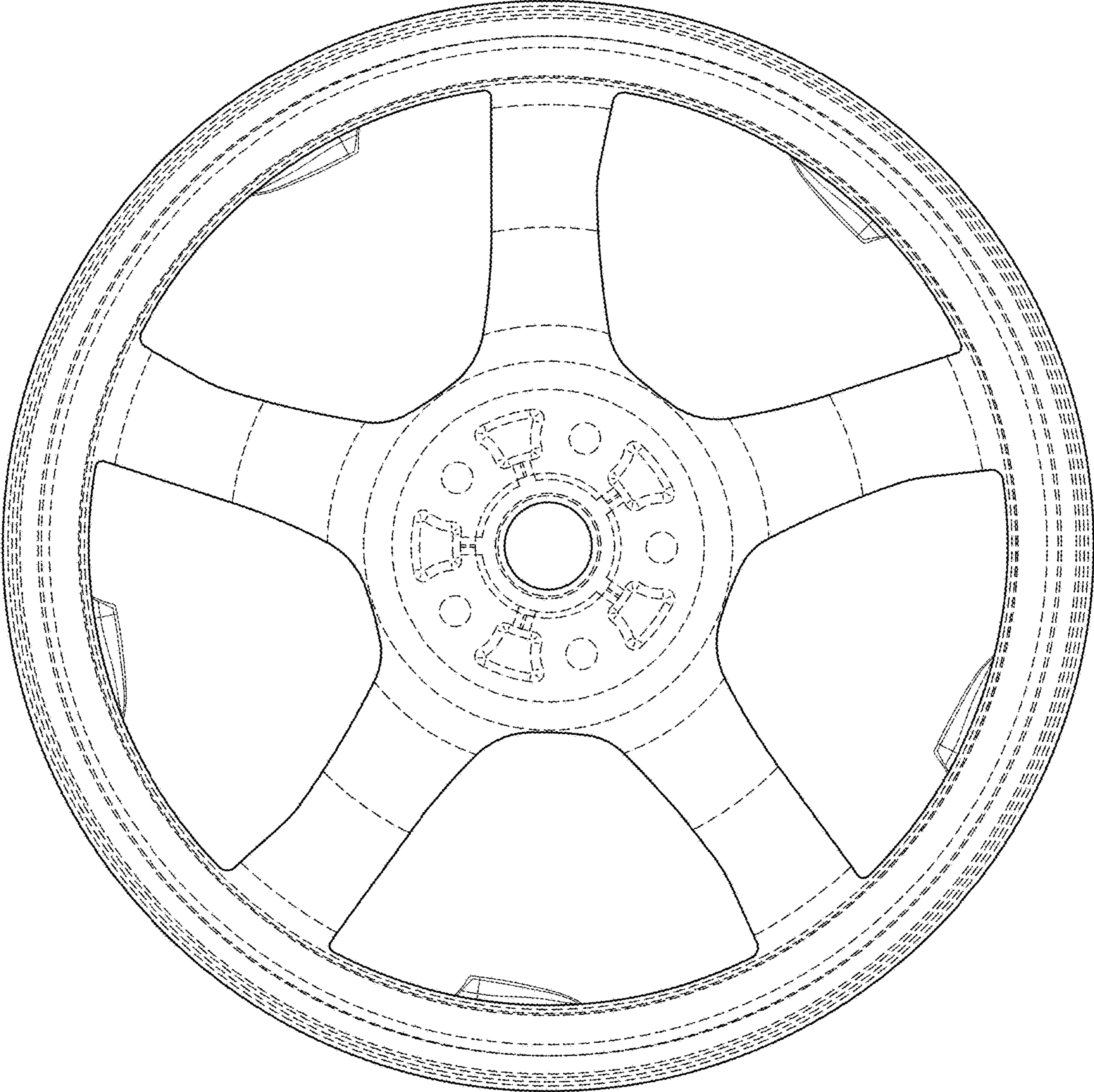

1.3

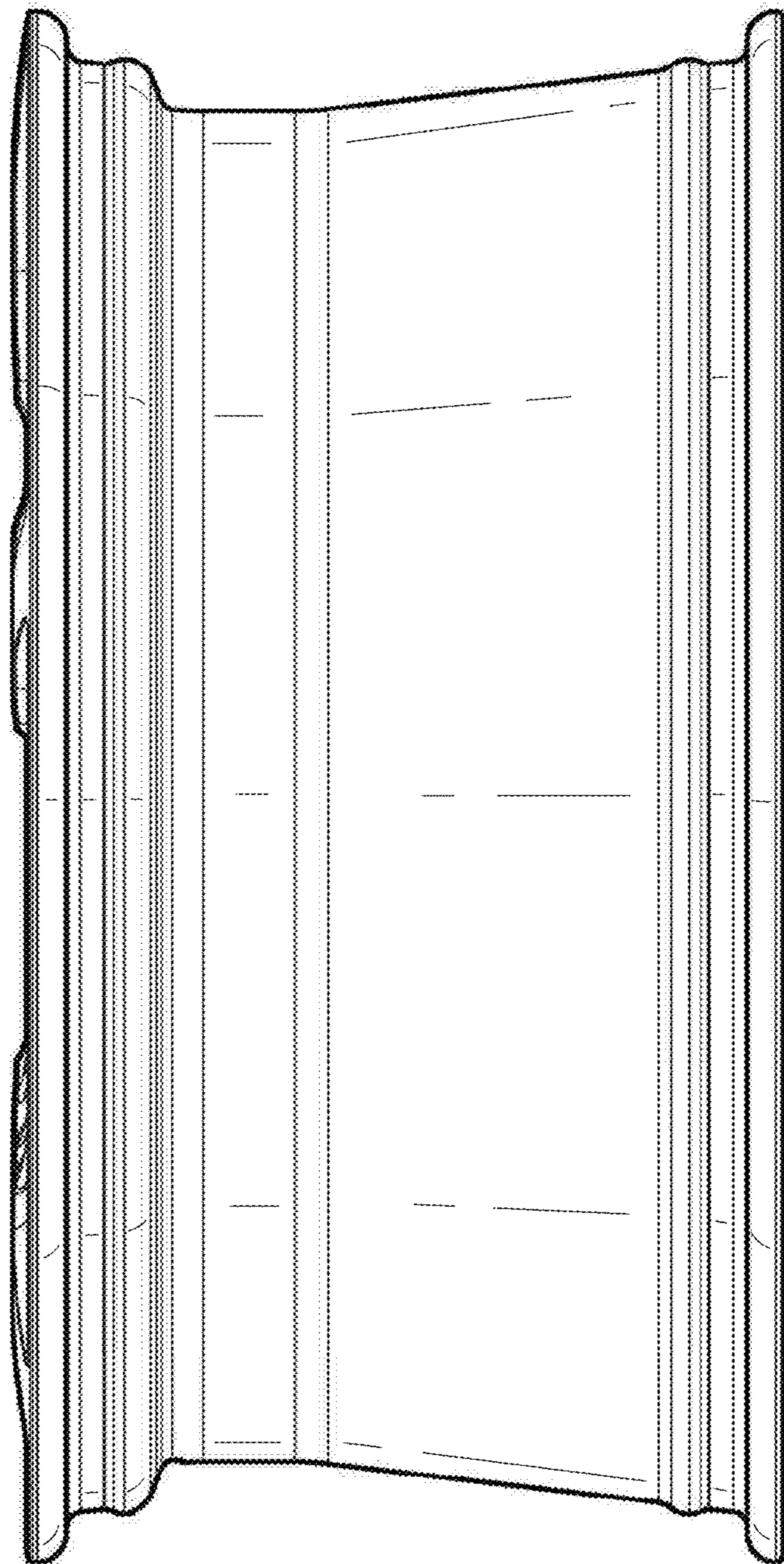

1.4

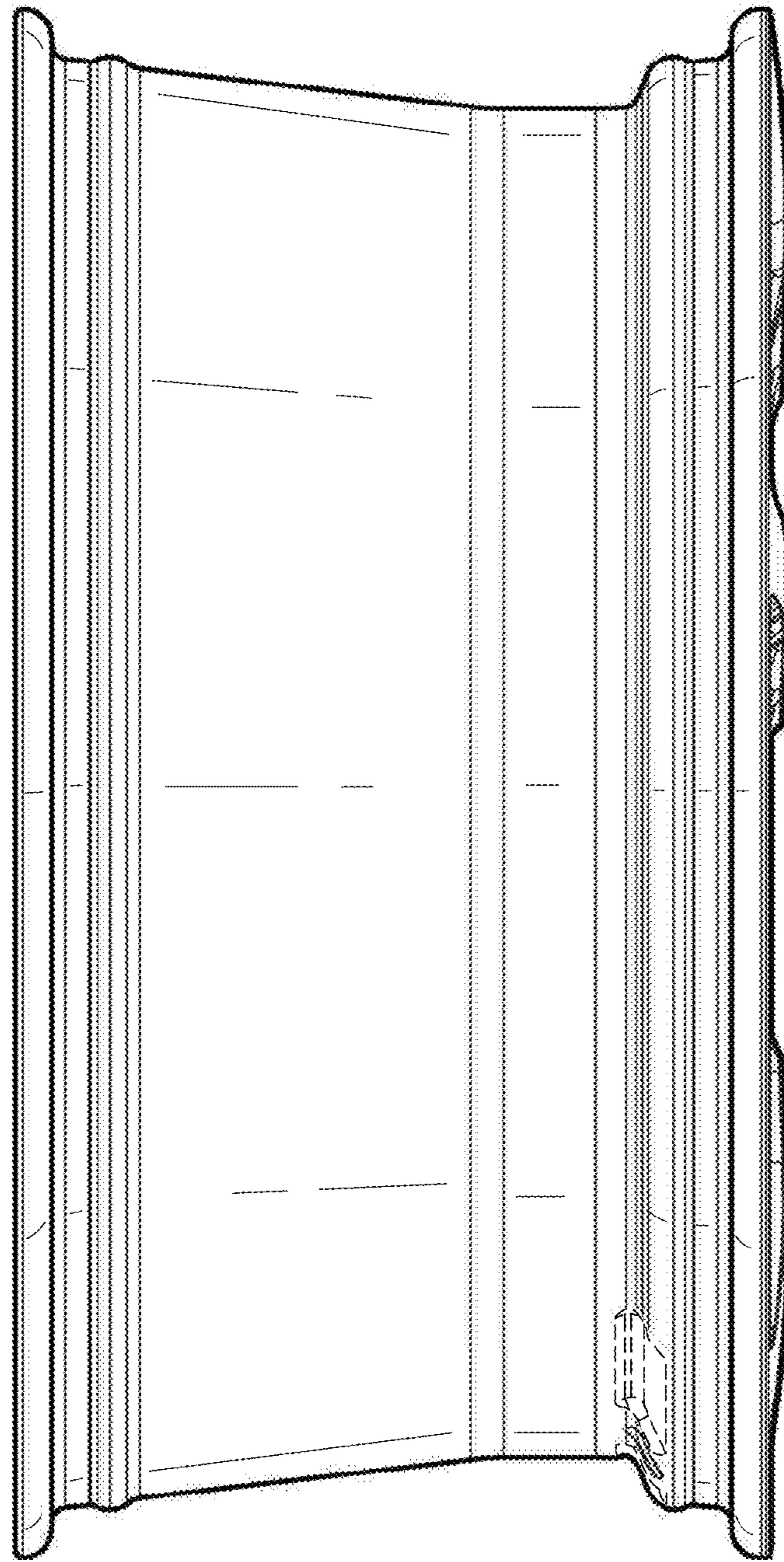

1.5

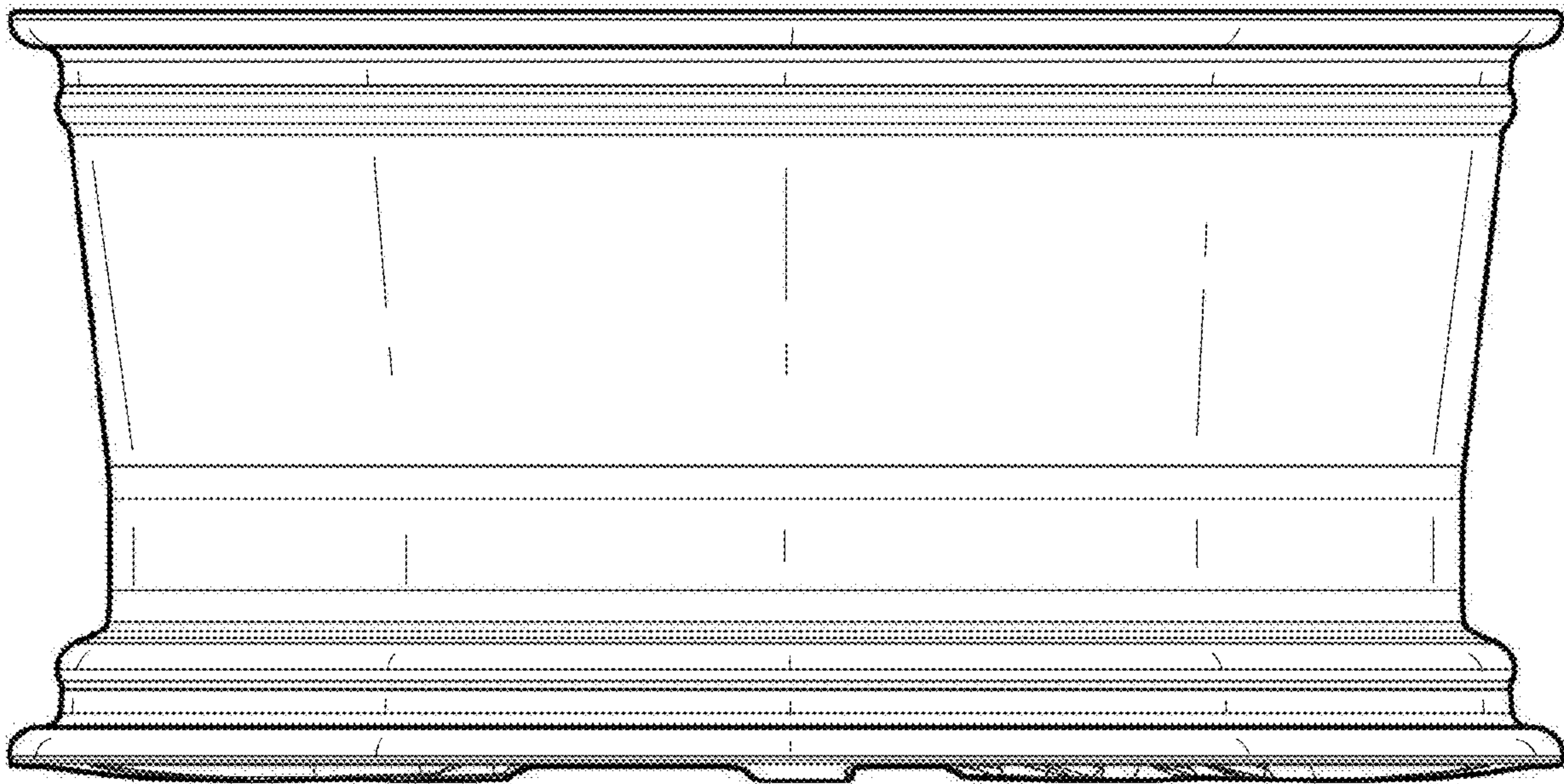

1.6

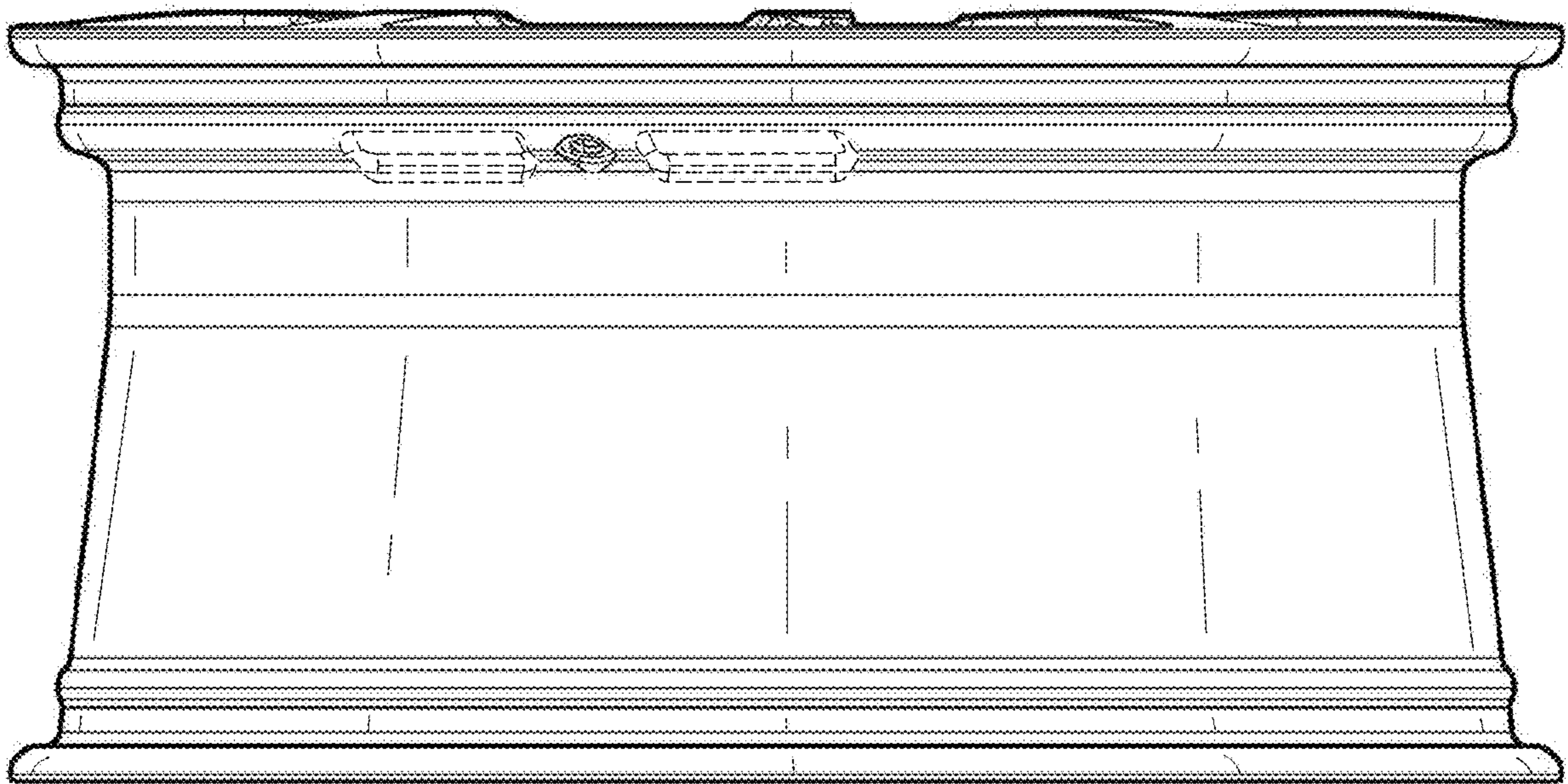

1.7

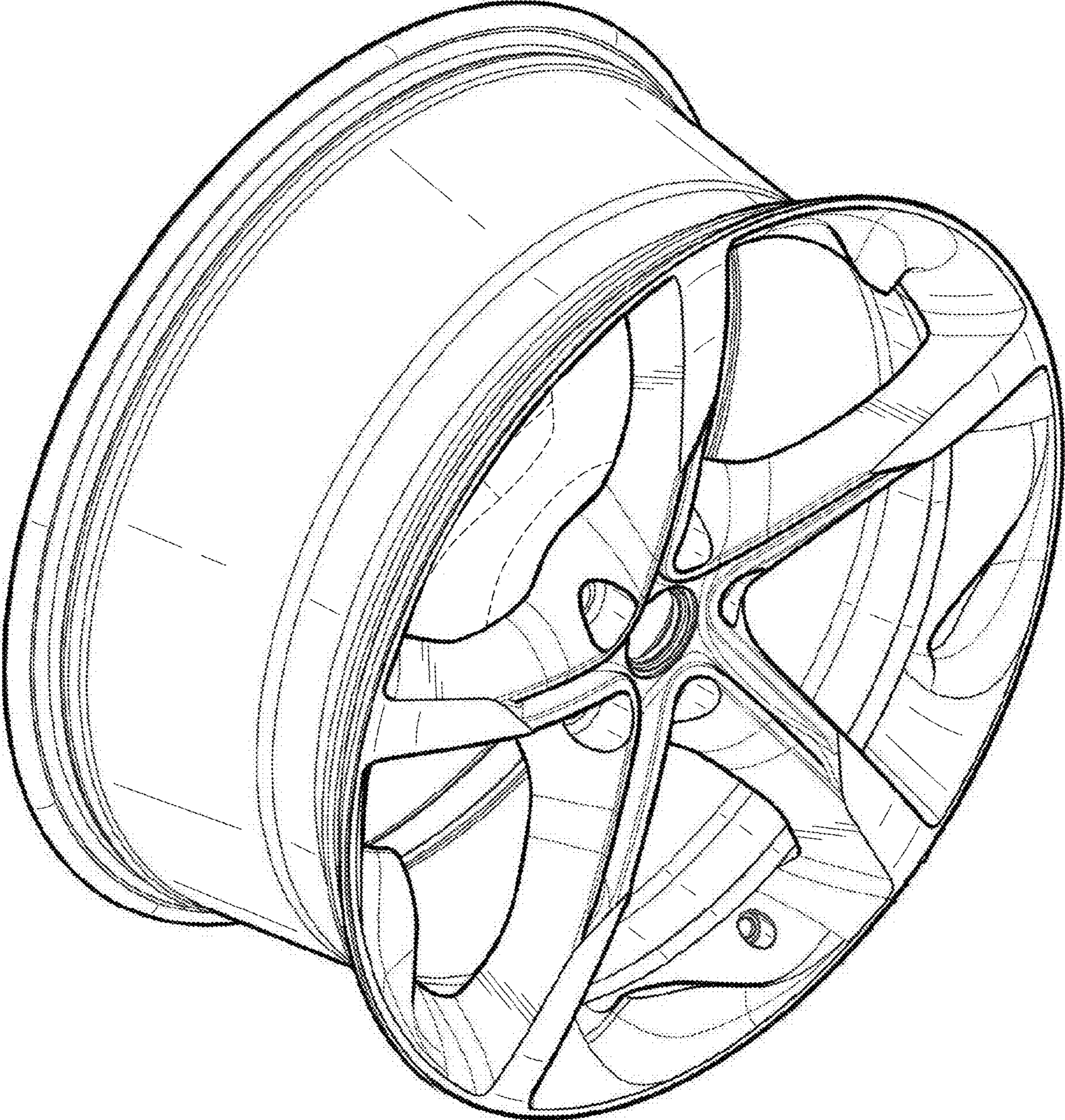

4.1

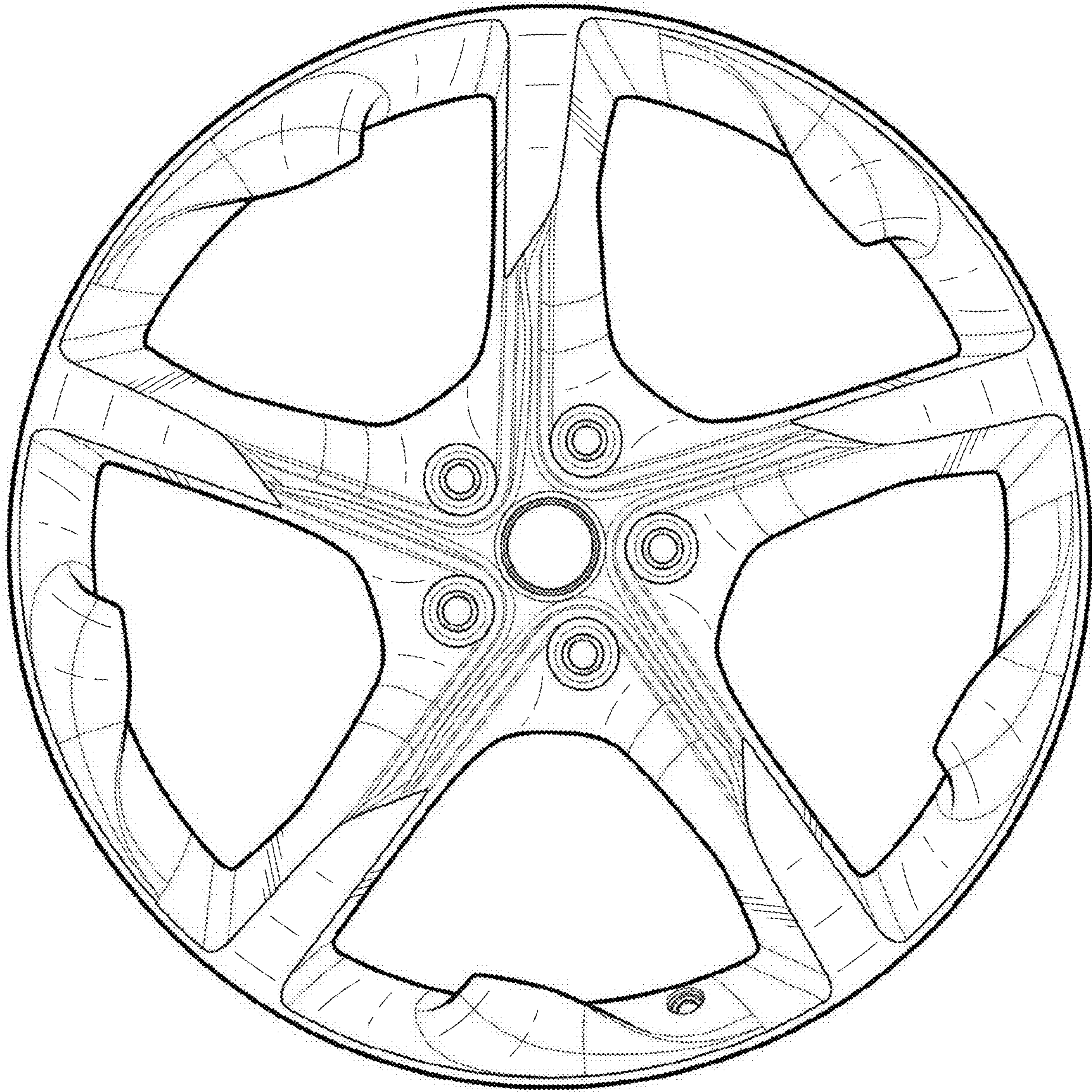

4.2

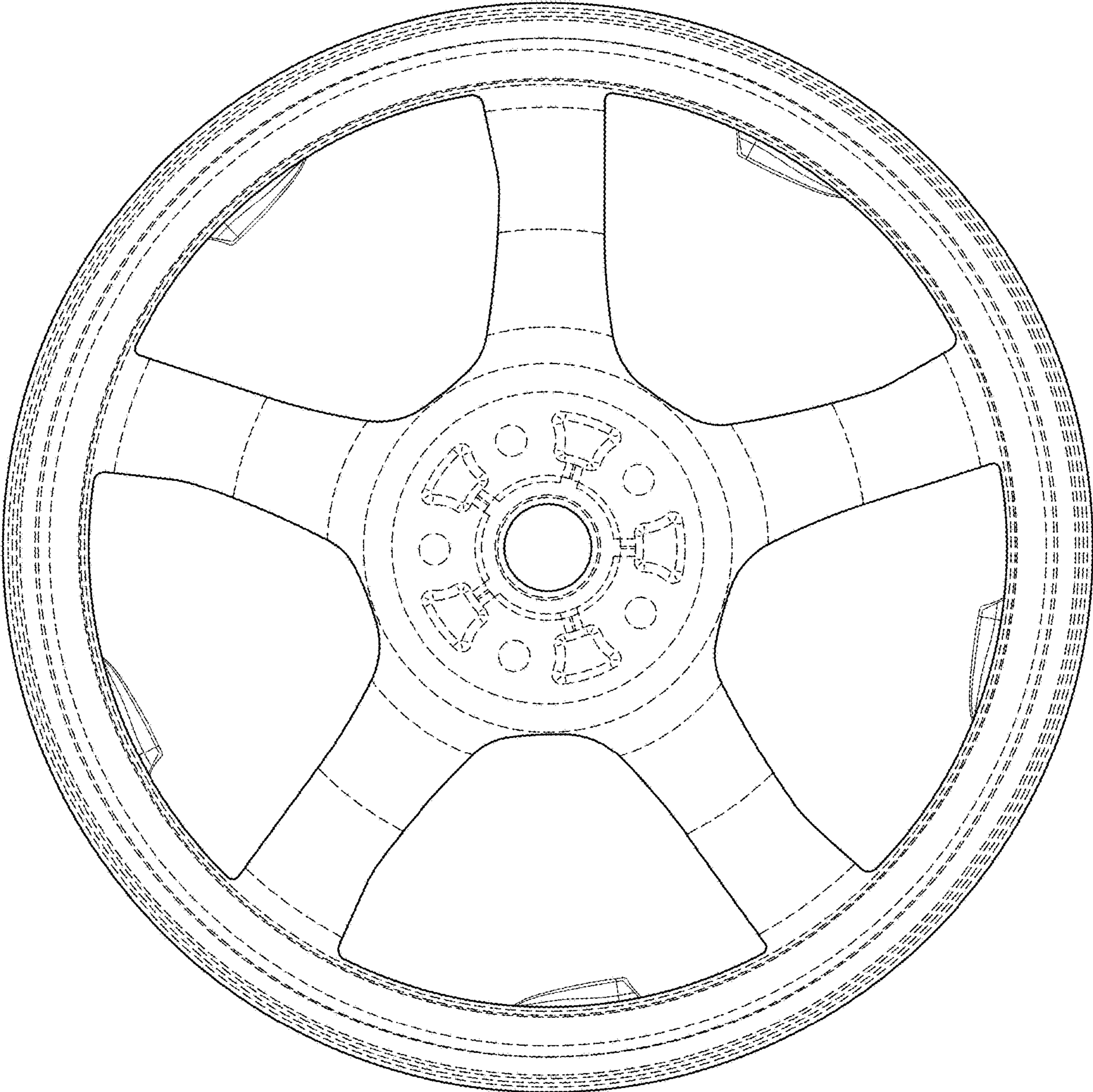

4.3

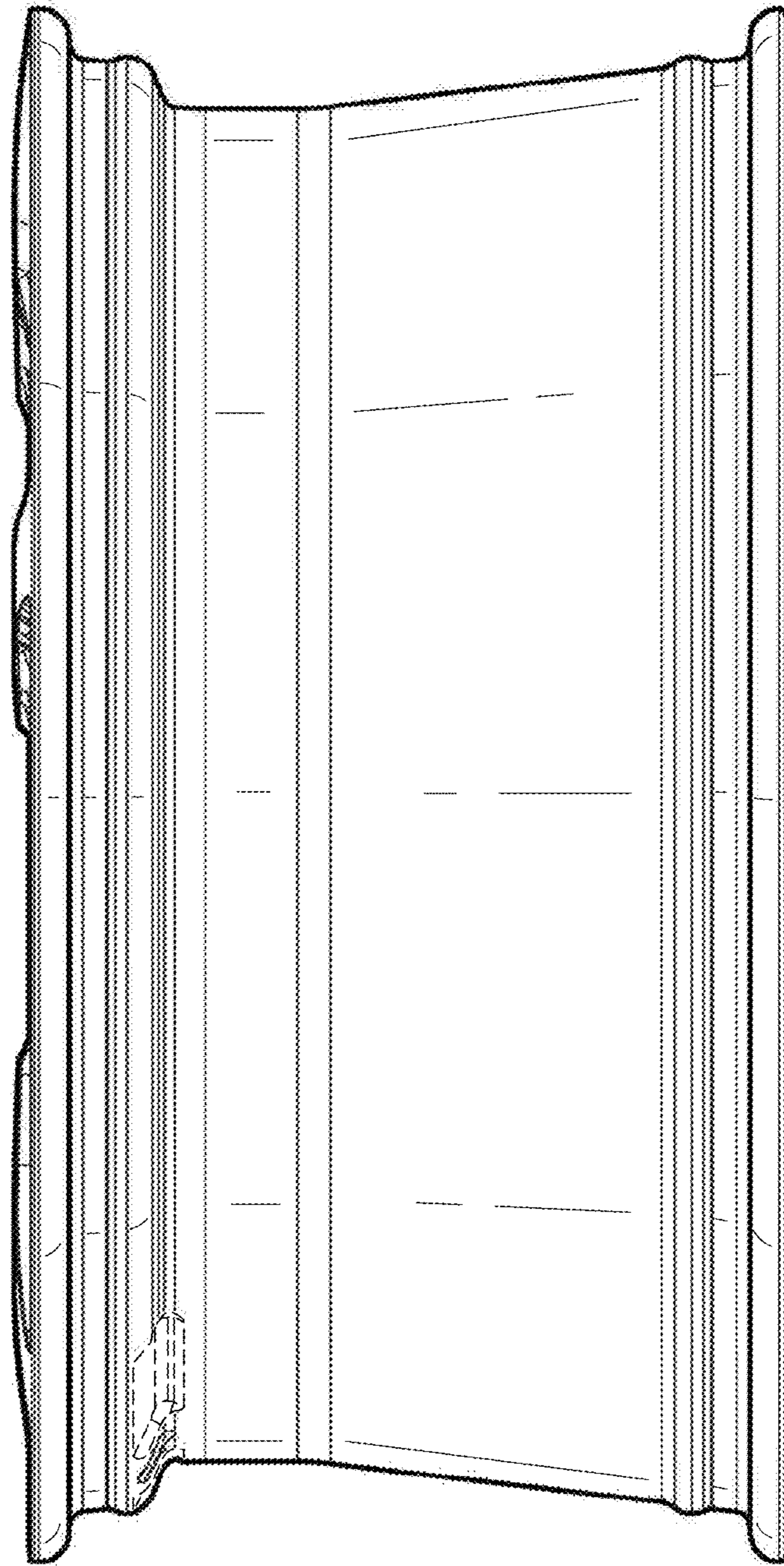

4.4

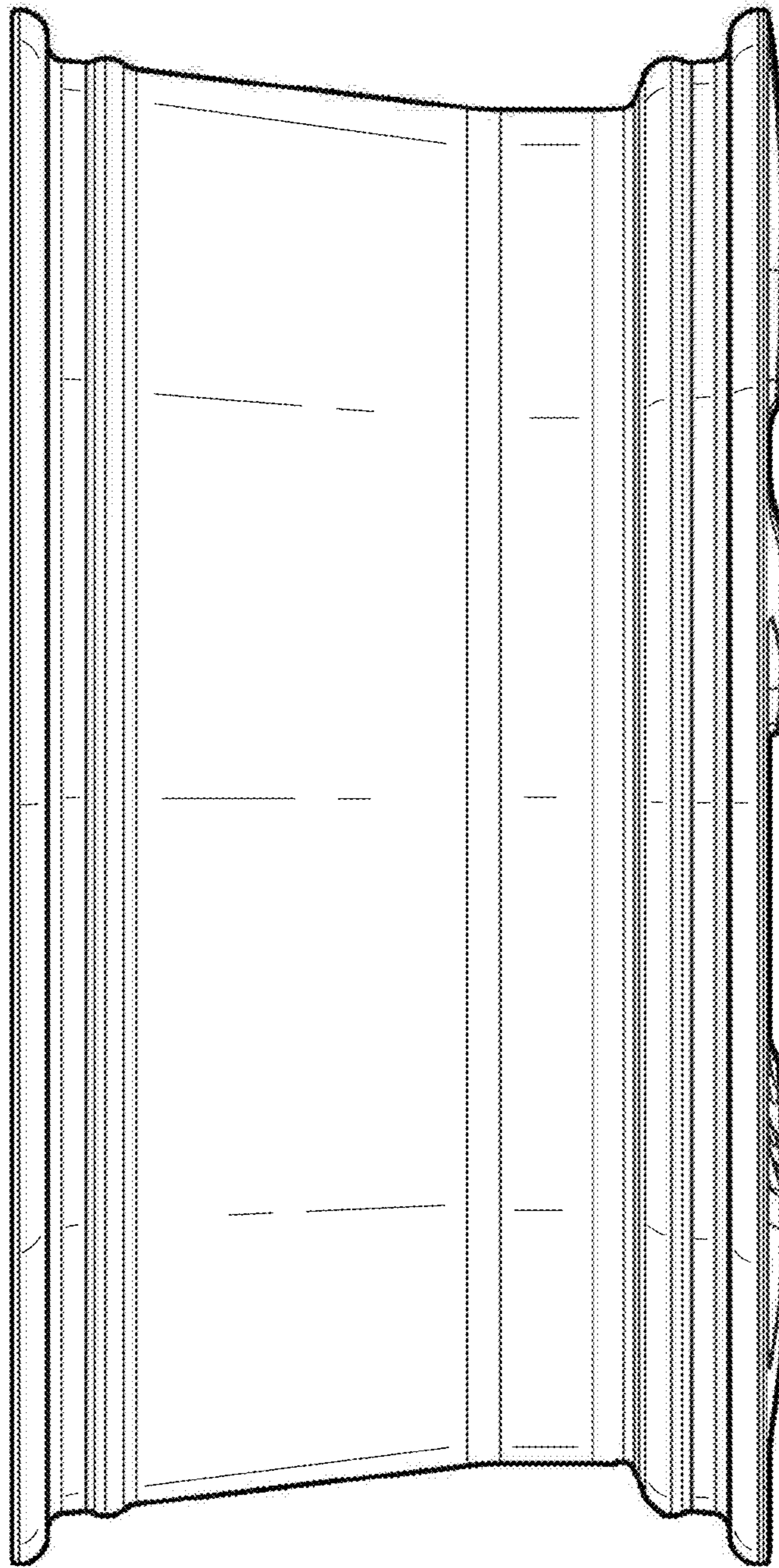

4.5

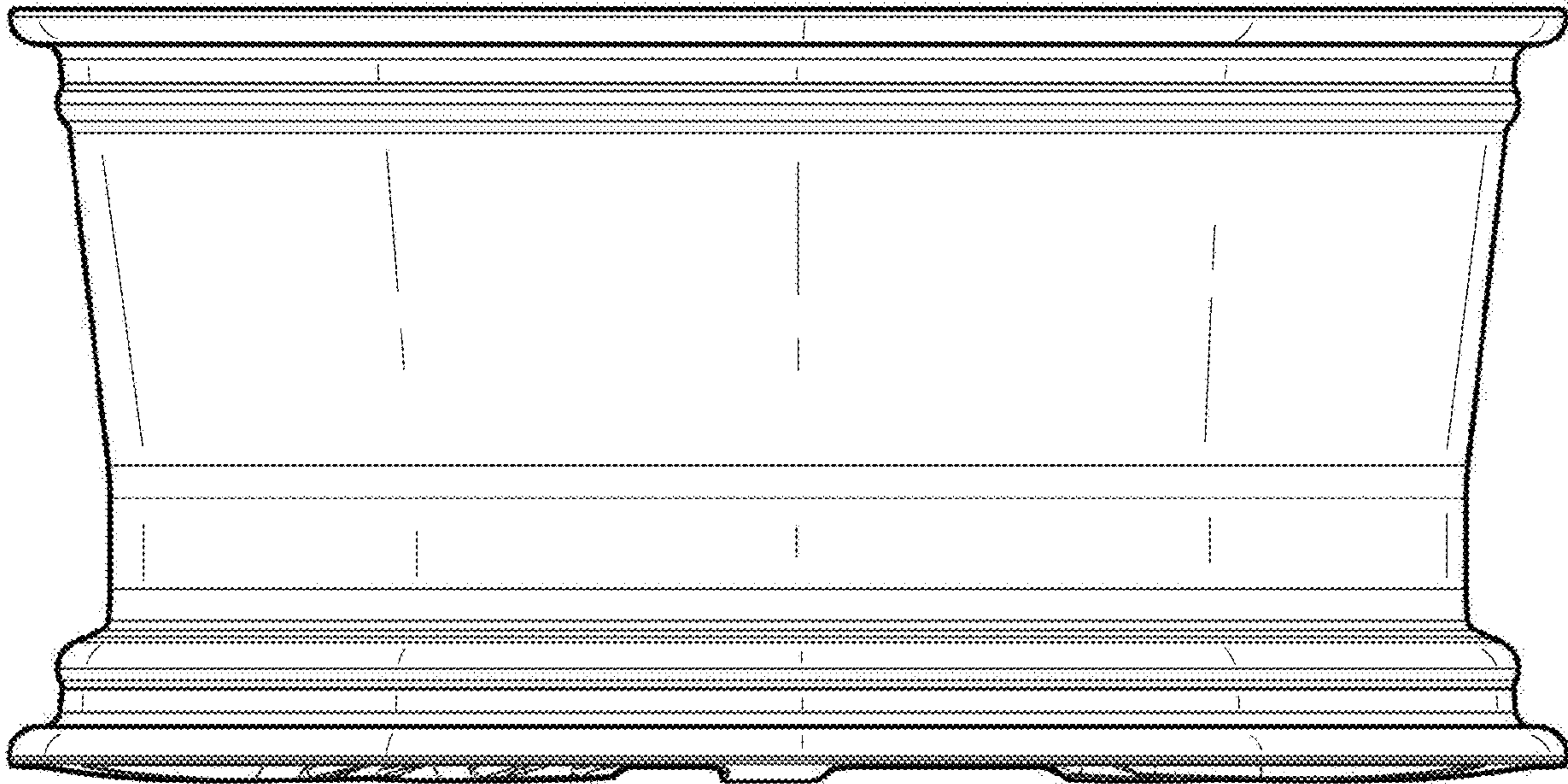

4.6

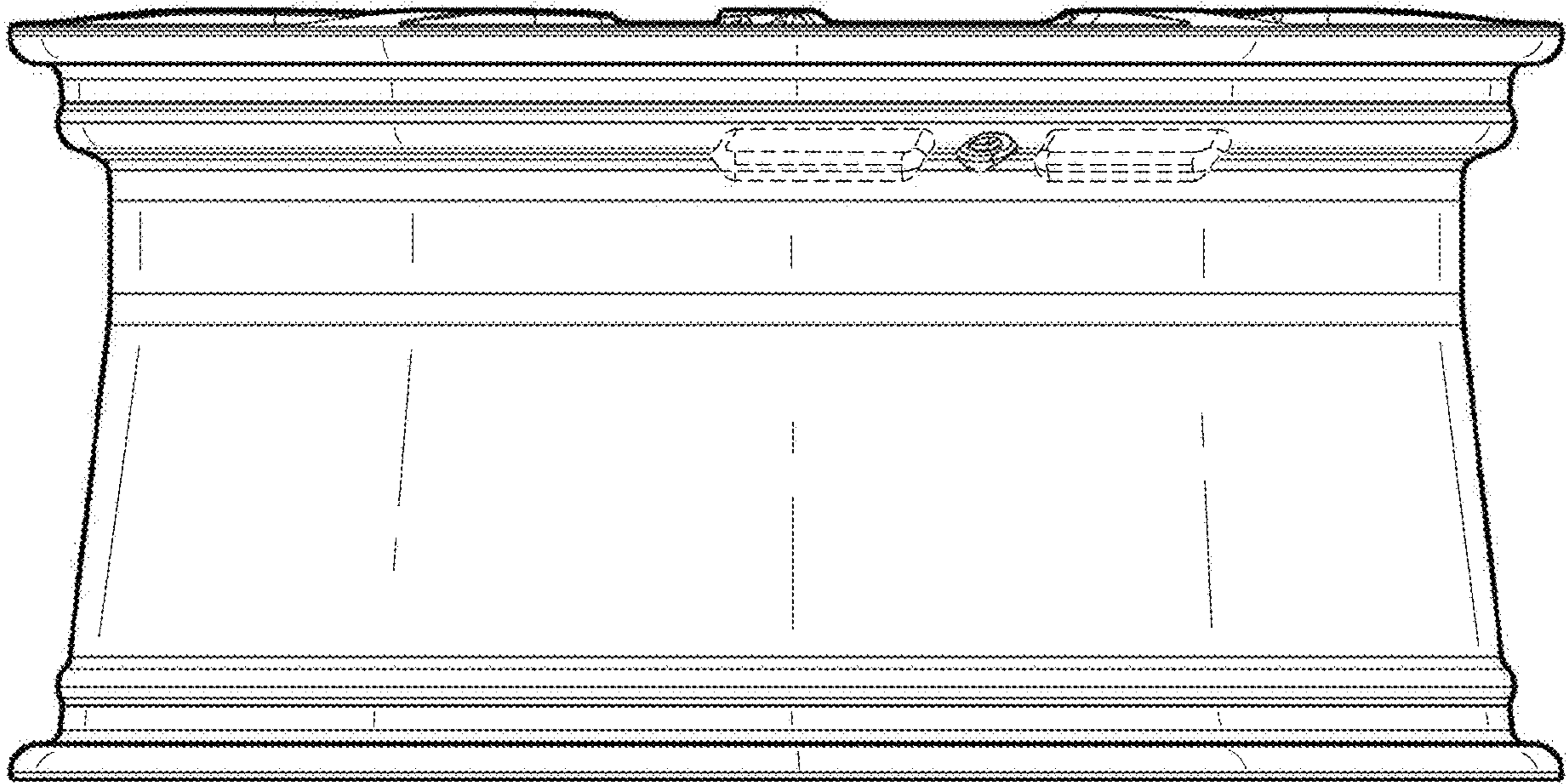

4.7